

Holographic interferometry with photorefractive crystals. Early experiments and results of the ongoing european project PHIFE

^aMarc GEORGES, Cédric THIZY, Philippe LEMAIRE,

^bGilles PAULIAT, Gérald ROOSEN,

^cIgor ALEXEENKO, Giancarlo PEDRINI,

^dSébastien RYHON,

^eNick COATES, Reinhard KELNBERGER,

^fRené SCHNITZER, Norbert RÜMMLER

^aCentre Spatial de Liège, Parc Scientifique du Sart Tilman, Avenue du Pré Aily, B-4031 Angleur (Liège),
Belgium, ph : 32-4-3676668, fax : 32-4-3675613, email: mgeorges@ulg.ac.be

^bLaboratoire Charles Fabry, Unité Mixte de l'Institut d'Optique, du Centre National de la Recherche
Scientifique et de l'Université Paris Sud, Bâtiment 503, 91403 Orsay Cedex, France, ph : 33-1-69358755

^cInstitut für Technische Optik, Universität Stuttgart, Pfaffenwaldring 9, D-70569 Stuttgart, Germany

^dOptrion S.A., rue des Chasseurs Ardennais, B-4031 Angleur (Liège), Belgium, ph : 32-4-3729333

^eInnolas, Somers Road, Rugby CV22 7DG, United Kingdom

^fAmitronics, Angewandte Mikromechatronik GmbH, An der Hartmühle 10, D-82229 Seefeld b. München,
Germany

Abstract

Photorefractive crystals offer many advantages over other classical holographic recording media. They allow fast in-situ processable holographic recording as well as indefinite reusability. Moreover high signal-to-noise ratio can be reached as well as high resolutions. We present several types of holographic instruments using such materials. Here we will emphasize their applications in vibration measurements. A first one is based on the classical stroboscopic technique, a second one uses a pulsed laser. We describe also the recent results obtained in the framework of the european project PHIFE (Pulsed Holographic Interferometer for the analysis of Fast Events), aiming at developing a full field measurement system of vibrations modes at high repetition rate.

1 Introduction

Holographic Interferometry (HI) [1,2] is a technique working under coherent light and that allows to produce the interference of two wavefronts (or more), at least one of which being holographically stored. The interference pattern called interferogram shows the Optical Path Difference (OPD) between the wavefronts as intensity variations (fringe patterns). In most cases, the OPDs comes from the same object at two different instants. In the case of the opaque scattering objects, the variations arise from the displacement or deformation of the surface, while in the case of transparent objects, they come from thickness or refractive index variations.

Three main methods of HI exist. In real-time HI (RTHI) only one hologram is recorded. At the readout step, the object is still illuminated and one observes the interferogram resulting from the superimposition of the wavefronts diffracted by the hologram and the one coming directly from the object (transmitted through the hologram). Each object variation is then observed directly (*live fringes*). The double-exposure HI (2EHI) requires the recording of two holograms of the object at different status. A further readout step

(without the object beam) shows the superimposition of both stored wavefronts (*frozen fringes*). For both methods, the interferogram is written in each point (x, y) of an observation plane as

$$I(x, y) = I_{average}(x, y) [1 + m(x, y) \cos(\phi(x, y))] \quad (1)$$

with $I_{average}(x, y)$ the average intensity and $m(x, y)$ the contrast. The quantity $\phi(x, y)$ is the phase difference between the transmitted and the diffracted wavefronts and that has to be determined in order to calculate the OPDs.

A third technique can be applied for the case of vibrating objects : the time-average HI (TAHI). The hologram is recorded during the vibration of the object and over a time longer than the vibration period. Here the phase difference is time dependent and written as $\phi(x, y, t) = \phi_0(x, y) \sin(\Omega t)$, where ϕ_0 is the amplitude and Ω the pulsation of the vibration. The intensity pattern is given by $I(x, y) \propto J_0^2(\phi_0(x, y))$, where J_0 is the zero-order Bessel function whose maximum is found at the vibration node and whose fringe modulation decreases when ϕ_0 increases.

The properties of the holographic recording medium used in HI are the key factors to the success of this technique. Traditional media (silver halide plates, thermoplastics) do not make the hologram immediately available because of their respective physico-chemical processing. This is why recent works in the holographic-based measurement techniques turn to recording media allowing a quasi-instantaneous availability of the information. First the holographic recording can be performed directly on CCD cameras. It is the well known Electronic Speckle Pattern Interferometry (ESPI), or equivalently TV-holography techniques [1,2], and more recently digital holography [2].

Photorefractive crystals (PRCs) [3-5] are holographic recording media that constitute an alternative to the classical holographic media as well as to CCD. The main interest of photorefractives in this case is that they do not constitute a limit regarding the holographic acquisition time since recordings can be performed at the nanosecond time scale, which is much faster than the natural barriers of frame transfer duration that face CCD-based systems.

Our works are based on PRCs of the sillenite family ($\text{Bi}_{12}\text{SiO}_{20}$ (BSO), $\text{Bi}_{12}\text{GeO}_{20}$ (BGO), $\text{Bi}_{12}\text{TiO}_{20}$ (BTO)) [8,9] that have proved they were promising recording materials for HI in the blue-green spectrum. In these crystals charge migration appears, under the photoconduction effect, between illuminated and dark zones that result from the interference between two incident mutually coherent beams (object and reference). After charge trapping in crystal defects of the dark zones, a local space charge field is created and modulates the refractive index, through the linear electro-optic effect, creating a phase hologram. This process is dynamic and reversible. The hologram is building up with a certain time constant and reaches a saturation level. The two important figures of merit to consider in applications are the diffraction efficiency and the recording energy density.

First, the diffraction efficiency is simply the ratio between the diffracted beam intensity and the readout beam entering the crystal. PRCs have relatively small efficiencies compared to other media (10^{-3} to 10^{-4}). Nevertheless this is not a problem if one considers special properties of the crystals such as coupling effect [7] or anisotropy of diffraction [5,10]. Second, the energy density of recording is a constant of the materials when several experimental parameters are fixed (wavelength, angle between beams, value of external electric field). The energy density is the quantity of luminous energy by unit surface that is necessary to reach the saturation of holographic recording. For a BSO crystal with 50° between recording beams and no electric field, its value is about 10 mJ/cm^2 . This quantity is the product between the response time of the crystal and the total intensity of the recording beams. An important consequence is that the hologram can be recorded either with continuous or pulsed lasers. At the present state-of-the-art, one can say that PRCs have practically no limit in the response speed since they (at least) respond at the nanosecond scale.

Besides this dynamic behaviour, PRCs present interesting features. Mainly we can distinguish two separate configurations related to the polarization state of the diffracted beam, either anisotropy or

isotropy of diffraction can occur. In function of the application we can choose the suitable diffraction behaviour. Each one of these processes is authorized by a suitable choice of the direction of the grating wave vector with respect to the crystallographic axes, the polarization states of the recording beams and the direction of an external electric field. In the applications described here, no external electric field is applied. The reason is that, without applied field, the diffraction is maximized at large angle between recording beams, what is more advantageous if one wants to use short focal lengths objectives in front of the crystal for observation of large objects [11].

Pioneering experiments of vibration analysis using HI with sillenite PRCs consisted of time-averaged HI [12,13]. These works have shown that PRCs are particularly well suited for time-averaged HI. With conventional non-self processable media, the hologram has to be recorded when the object is close or at a resonant mode, what is a drawback because a large number of recordings with different holographic plates is necessary to obtain a few images of mode shapes. With PRCs, this is much simpler : the sinusoidal excitation frequency is scanned and, when the resonance is reached, the image of the mode immediately appears. The drawback of time-averaged HI is that it is not adapted to quantitative measurement. Indeed the Bessel-function fringe profile is not adapted to techniques, such as phase-shifting, that are associated to HI in order to obtain automated quantification of the displacement. These techniques consist in computation of $\phi(x,y)$ inside the cosine function of expression (1).

In this paper we present different holographic interferometers that have been developed with PRCs. Contrarily to the above discussed examples, we use real-time HI : a hologram is recorded in the crystal and furtherly readout when the object is moving due to vibration. One then observes the interference between the beam diffracted by the crystal (replica of the object state at the recording) and the beam directly transmitted through the crystal, showing the optical phase difference between the two object states at the recording and the readout. The advantage of the real-time method is that sinusoidal fringe profiles are obtained, allowing proper application of usual phase quantification techniques, such as the phase-shifting. In the following, we will describe two instruments. The first one uses a continuous Nd:YAG laser and stroboscopic readout (section 2). The second one uses a pulsed laser (YAG Q-switch), one pulse is used to record the hologram at any moment of its vibration and the second pulse at another instant of the vibration (section 3). For both examples we will describe the working principle as well as applications. We will conclude this paper by presenting the objectives of an EC-funded project (PHIFE) in the field of pulsed illumination HI for vibration analysis.

2 Stroboscopic holographic interferometry with continuous laser

2.1 Description of the instrument and its working principle

The device presented here is a simple adaptation of an instrument developed for non-stroboscopic applications, mainly non-destructive testing [10,11]. We will briefly recall its working principle and some basic performances. The technique we use here is extremely straightforward and simple to implement, it is referred as self-diffraction and is associated to anisotropy of diffraction. The object and readout beams are continuously incident on the crystal. A hologram is then recorded within the response time, depending on the crystal sensitivity (function of the species and the geometry) and on the total incident intensities [8,9]. If the object undergoes a deformation, one directly observes the corresponding interferogram and the phase-shifting process can be started, if needed. This is called the self-diffraction because the readout beam is exactly the same than that serving during the recording. From that moment, a new hologram corresponding to the new object state is under recording, erasing the previous one. The interferogram is then vanishing within the response time, but generally we use beam intensities such that the response time is long enough to allow image capture by a frame grabber. It has to be noted that the diffraction efficiency is notably low so there is a strong difference between the transmitted object and the diffracted intensities. The fact that the crystal is used in the « anisotropy of diffraction » configuration allows to overcome this difficulty. Indeed by suitably orientating a linear polarizer in front of the crystal, one can arrange that the diffracted wave has its polarization orthogonal to that of the direct wave. Then a polarizer is set after the

crystal in order to balance the intensities (for maximization of the fringe contrast) and reach high SNR interferograms [10,11].

Figure 1 shows the compact holographic camera that has been developed by the Centre Spatial de Liège [14] and which is now commercialized by the spin-off company OPTRION (www.optrion-tech.com). It is a cylinder of typically 25-cm length and 8-cm diameter with a typical weight of 1 kg. The laser light is brought to the optical head with the help of an optical fiber.

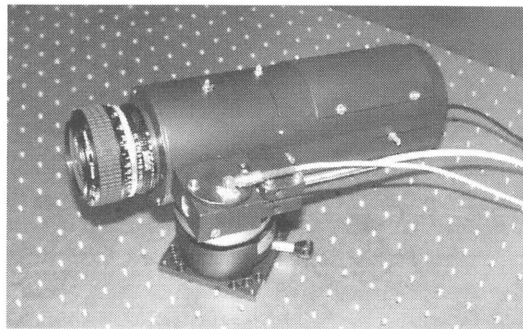

Figure 1. Compact holographic camera using a sillenite crystal.

For applications to vibration mode observation, we have associated this device to a stroboscopic readout [5]. The basics of this technique were deeply described by Nakadate *et al* [14]. The hologram is recorded when the object is at rest. Therefore, when the object is sinusoidally vibrating, the stroboscope is actuated in synchronization the excitation signal and such that the opening is operated around the maximum displacement position (figure 2), say at the instant the object is not moving. The stroboscope is open during a $2T$ time interval centered around this particular instant. The important parameter of the stroboscopic application is the duty cycle, i.e. the ratio between the opening time of the stroboscope and the vibration period τ .

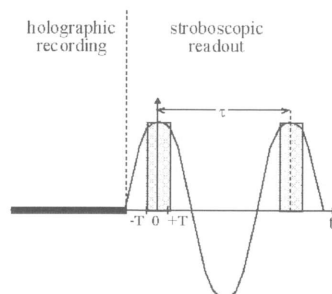

Figure 2. Real-time holographic interferometry with stroboscopic readout. The hologram is recorded when the object is at rest. The readout is performed when the object is vibrating. The stroboscope is open during a time interval $2T$ centered on the maximum object displacement.

The choice of the correct duty cycle is a compromise. On one hand, the higher the time interval $2T$, the higher the quantity of light received by the CCD camera. Therefore, for a given power used to illuminate the object, the larger will be the observed area. On another hand, the smaller the duty cycle, the better the

fringes contrast. This is obvious because if one increases the time interval $2T$, the image of the object is no longer stable but integrates different states of the moving object (from times $-T$ to T). Therefore the interferogram is blurred. In practice, duty cycles of 15 to 20% are used. Under these conditions and with a DPSS laser of 490 mW, typical object sizes of $25 \times 25 \text{ cm}^2$ can be reached in stroboscopic working mode. At the temporal level, during the stroboscopic readout, since a small portion of the light is used, the erasure time of the hologram (due to the photorefractive dynamic effect) is long, what is an advantage. Typically, one can have 1 minute for the stroboscopic readout. During this time we can then scan the excitation frequency step by step and see the mode appear. After this time, the hologram is too weak and the stroboscope has to be stopped to reacquire a fresh hologram of the object at rest, afterwards the stroboscopic readout is reactivated for further frequency scanning.

2.2 Applications

The test of the method has been performed on an aluminium plate of $23 \times 23 \text{ cm}^2$ with 1.5 mm thickness and which is clamped on 10 cm of its border. The vibratory excitation is given by a loudspeaker at the rear side of the object. A first operation consists in finding the resonant modes by scanning the frequency. Once a resonant frequency is found, the parameters on which we can act are the duty cycle and the phase delay between the excitation and the stroboscope opening (in order to center the $2T$ temporal window on the maximum of displacement). Once these parameters properly set, the measurement step can start : recording of the hologram of the object at the rest, excitation ON, synchronized stroboscopic readout with phase-shifting. Figure 3 shows the phase images of 3 modes. These can be easily related to surface displacement. Here, due to the geometrical configuration of the illumination beam and the observation, we measure out-of-plane displacements. We have to note the extreme quality of the fringes presented which are raw phase images. There is absolutely no filtering to reduce noise.

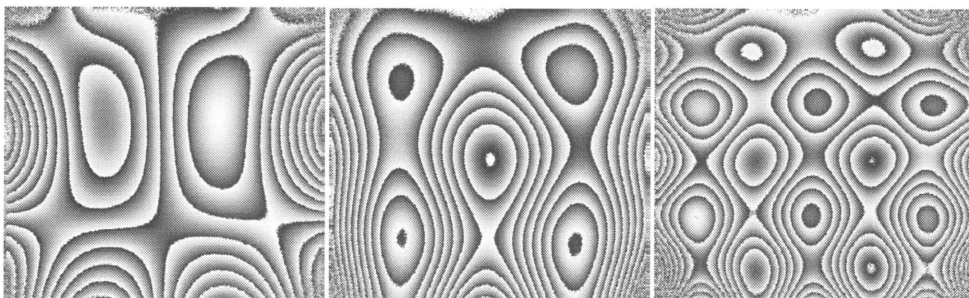

Figure 3. Phase image of different mode shapes of an Aluminium plate excited by loudspeaker

As a mature device giving high quality results together with a userfriendly working mode, this holographic camera has been transferred to the company OPTRION for service to industry and commercialization. Recently, the qualification of compressor blades developed by a major aeronautical manufacturer for a new aircraft engine has been performed by OPTRION. The purpose was to compare the resonance frequencies that are experimentally observed for well certified limit conditions with frequency values calculated by FEM. Figure 4 shows a sequence of mode shapes. The technique allowed to find resonance frequencies that were not predicted by FEM, showing that such certification technique is a worthy investment for this type of R&D.

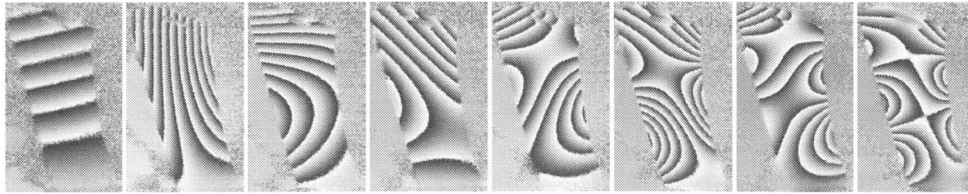

Figure 4. Some phase images of resonance modes of a compressor blade. The blade platform is on the bottom side of the images board (courtesy of Optrion).

Another interesting example is that of searching abnormal behaviour of microelectronic chip soldered on an electronic board. Figure 5 shows the phase images obtained at two resonant frequencies of the electronic board and which show that the chip is not properly attached to the board. Indeed the fringes are not correctly connected between the chip and the board.

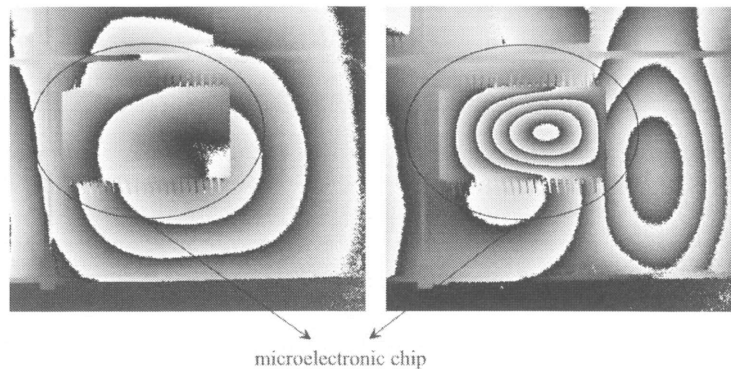

Figure 5. Vibration patterns of an electronic board on which is soldered a microelectric chip. The pattern show abnormal behaviour of the chip caused by a bad soldering to the board.

2.3 Concluding remarks

Real-time stroboscopic HI gives excellent quality observation of mode shapes. Nevertheless, it has the following limits. First, the stroboscopic readout process leads to a loss of light for the observation system (loss related to the duty cycle). This limits the size of the object to observe. With typical laser powers of 500 mW, this system is able to observe $25 \times 25 \text{ cm}^2$. When using the today's available lasers delivering 10 Watts (VERDI laser from COHERENT), the observed area can be typically 1 m^2 . Second, the displacement measured are in the interferometric range, say here typically ranged from 15-20 nanometers to 20-25 microns. Therefore, the excitation amplitude has to be kept at a level such that the number of fringes stays observable.

Despite these limits, this instrument is really userfriendly and allows easy observation of mode shapes for comparison with FEM purposes.

To overcome the above cited drawbacks, double-pulse lasers can be envisaged, one pulse for the recording, the next one for the readout. This has the advantage that no light is lost as with the stroboscopic readout. Second, if variable delays between pulse are available, the amplitude of displacement can be increased, because if the number of fringes is too high, it is sufficient to decrease the delay between pulses to obtain an observable fringes number. At last this opens the holographic technique to more hostile environments.

3 Multiple exposure technique based on pulsed lasers

3.1 Preliminary remarks

The Laboratoire Charles Fabry de l'Institut d'Optique (LCFIO) developed a photorefractive holographic camera operating in the pulse regime [6,7]. This instrument contains two CCD cameras allowing to capture two phase shifted images simultaneously during the holographic readout step. A preliminary measurement of the mean intensity of the image without interference fringes is however necessary to calculate the phase. Initially, this camera was designed for vibration analysis using a ruby laser. The main drawback is that the laser wavelength (694 nm) does not match the sensitivity range of BSO and BGO crystals. A copper doped BGO sample was specially grown¹⁵ to increase the sensitivity at 694 nm. Despite the optimized doping, the diffraction efficiency was still low and the vibration interferograms obtained in these conditions were quite noisy. Nevertheless, a measurement error of 1/15 of the wavelength has been obtained, which is quite acceptable.

Since then, the Centre Spatial de Liège (CSL) and LCFIO have carried on this work together [16]. The laser used is a frequency doubled Q-switched YAG (COHERENT Infinity) whose wavelength is naturally adapted to sillenite crystals. For these new experiments, and for those described hereafter, the photorefractive crystal is a BGO sample. It is cut along the so-called beam coupling configuration : the beams enter the crystal by the $(1\bar{1}0)$ crystallographic face, the grating wave vector being along the $[110]$ axis. The input faces (3 cm x 3 cm) are anti-reflection coated; the crystal thickness is 1 cm. Such high optical window allows one to relax constraints related to imagery as well as to increase the amount of light collected by the imaging system.

3.2 Working principle

Since it is again the real-time HI method, a first pulse records the hologram of the object at some instant, the object is then visualised through the crystal whilst the hologram is reconstructed by the second pulse. Many constraints have to be taken into account:

1°) the crystal must receive a certain energy density to write the hologram (for BGO crystals, about 15 mJ/cm²). This energy is mainly brought by the reference beam, since the studied object generally scatters light. To obtain a hologram with satisfactory diffraction efficiency, the whole energy of the laser has to be used with the adequate ratio between object/reference beams energy.

2°) the second pulse must not degrade the hologram recorded by the first pulse, the energy in the reference arm must therefore be reduced for this second pulse.

3°) during the hologram readout, the CCDs must not be bloomed. The energy in the object arm must therefore be reduced too.

The last two points imply a decrease in the energy sent into the system for the readout, as well as a change in the ratio between object/reference energies. The laser we used (COHERENT INFINITY) has a simple cavity and its energy cannot be modified from one pulse to the next one, which implied to implement an external system of balance in energy between the two pulses. It is based on Pockels cells (modifying the beam polarisations) and polarising beam splitters.

The experiment set-up is shown in figure 6. The laser beam is split into object and reference beams by a first polarising beamsplitter (PBS1). The energy balance for the first pulse is adjusted using the half-wave plate HWP1, the Pockels cells 1 and 2 are not activated. During the second pulse, a half-wave voltage is applied to the Pockels cells. Pockels cell 1 is adjusted such that a few mJ energy beam illuminates the object without blooming the CCDs (see 3° above). The remaining energy is sent in the reference arm, the Pockels cell 2 is then also charged with a half-wave voltage, what rotates the beam polarization and, through the second polarising beamsplitter (PBS2), redirect most of the energy into a trap. The energy in

the reference is therefore low enough to read the hologram without recording a new one (see 2°). A delay line is introduced in the reference path (2 movable mirrors M1 and M2) so as to equalise the optical paths of both arms.

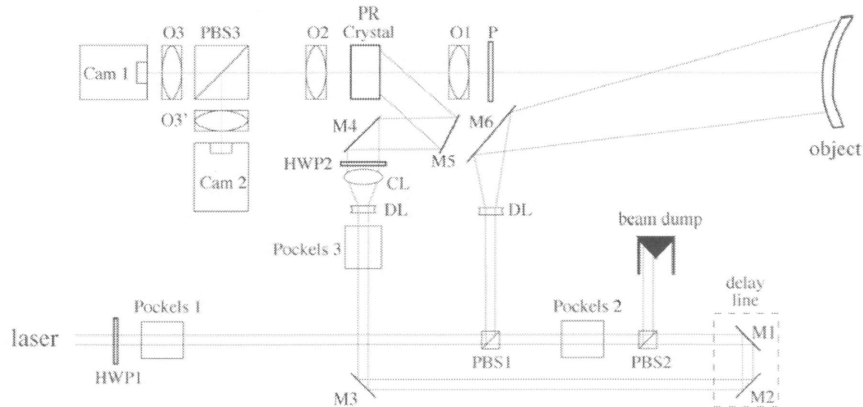

Fig. 6. Pulse holographic camera set-up

The particularity of the holographic set-up stands in the simultaneous acquisition system with the two CCDs (Cam1 and Cam2). These are located after a polarising beamsplitter (PBS3) and make the image of the same object field through identical imaging objectives. For the writing, the beams incident on the crystal have the same linear polarisation (set by the polariser P for the object beam, and by the half-wave plate HWP2 for the reference beam). For the reading, the reference is circularly polarised by applying a quarter-wave voltage to Pockels cell 3, while the object beam stays linearly polarised. The PBS3 splits the transmitted and diffracted beams towards the two CCD cameras. The circularity of the diffracted beam polarization allows to introduce the $\pi/2$ phase-shift between both simultaneously acquired interferograms. In order to properly apply the phase-shifting algorithm, average intensity images have to be taken prior to the measurement itself.

3.3 Optimisation experiment

Before starting the vibration measurement experiment, it seemed opportune to us to investigate the optimal working conditions, that is to determine the object and reference energies for the writing and the reading of holograms. Based on a preliminary experiment [16] with a lower energy laser, we were able to evaluate the observable surfaces as a function of the energy available. Figure (7a) shows one of the two phase shifted interferograms of a rotated object. It is an aluminium plate with ground finishing (non-specularly reflecting) whose surface is $20 \times 20 \text{ cm}^2$. For the writing pulse, the object energy is 300 mJ and the reference one is 40 mJ. For the reading pulse, energies are 6 mJ for the object and 6 mJ for the reference. Figure (7b) shows the phase calculated from both interferograms, and figure (7c) shows the displacement in microns. The measurement accuracy is typically $1/20$ of the wavelength, that is 26 nm.

$$D_1 = A_f \left[\cos(\phi_f + \omega\tau + \omega t_0) - \cos(\phi_f + \omega t_0) \right] \quad (4)$$

The same operation is repeated 1/4 of period later (W2, R2), the displacement is now

$$D_2 = A_f \left[\cos(\phi_f + \omega\tau + \omega t_0 + \pi/2) - \cos(\phi_f + \omega t_0 + \pi/2) \right] \quad (5)$$

The amplitude of the frequency response in every image point (x,y) and at a frequency ω is then given by

$$A_f = \sqrt{\frac{D_1^2 + D_2^2}{2(1 - \cos(\omega\tau))}} \quad (6)$$

Applying this technique at high frequencies, but with a laser emitting one pulse at a maximum rate of 30 Hz, required to spread the 4 pulses W1, R1, W2, R2 over different periods, the object keeping the same excitation frequency. A synchronisation process of the laser and the frequency generator used to vibrate the object has therefore been implemented. A PC controls the whole experiment, including the lasing.

Figures 9(a) and 9(b) show interferograms obtained for an aluminium plate (with surface $15 \times 8 \text{ cm}^2$) clamped on the bottom side and excited by a loudspeaker. The images shown are those recorded by one of the two cameras. Figure 9(a) was obtained for the first reading R1, while 4(b) was obtained for the second reading R2, a fourth of a period later. The frequency of excitation is 78 Hz. From these interferograms, one can calculate the displacements D_1 and D_2 , from which the amplitude A_f of the vibration is obtained.

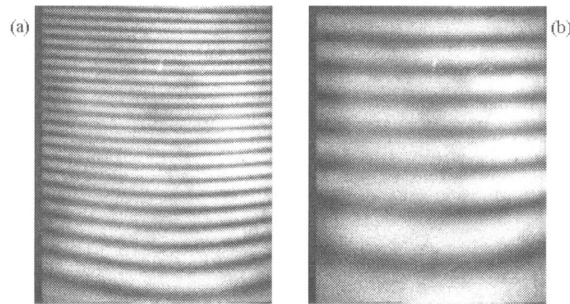

Fig. 9. Interferograms for a plate vibrating at 78 Hz and clamped at its bottom side: (a) obtained at $t_0 + \tau$ (R1), (b) obtained at $t_0 + \tau + T/4$ (R2)

Figure 10 shows a series of interferograms (taken at R1 by one of the two cameras) at different frequencies, when a resonant mode is detected.

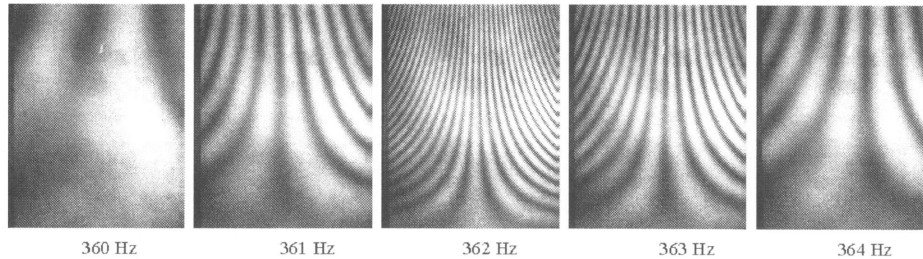

Fig. 10. Interferograms of the plate for different frequencies around a resonant frequency.

After calculation of the displacements D_1 and D_2 for different frequencies, the amplitude of the response of the plate (and its mount) as a function of frequency can be determined for any of the points of the image. Figure 11 shows the amplitude for two points of the plate, (a) close to the upper border, (b) close to the clamped border. These two curves show that the amplitude of the modes depends strongly on the location of the measurement point. This is the clear advantage of such a full field technique compared to measurements performed on one or a few points.

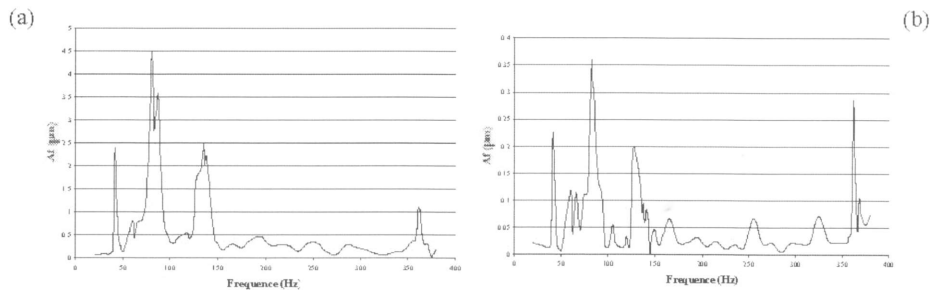

Fig. 11. Amplitude of the frequency response for two points of the plate.

3.5 Concluding remarks

From these experiments, it appears that a dynamic holographic camera based on PRCs is compatible to a multiple pulse vibration measurement technique. The photorefractive behaviour allows a fast reutilization of the device and then a fast scan in frequency. In the above experiments, the time of a single frequency measurement was limited to 15 seconds, including interferogram capture and savings them on hard disk. In the future works, it is expected to decrease this time appreciably.

4 Present developments : the PHIFE project

4.1. Goals of the project

An EC-funded project, PHIFE (Pulsed Holographic Interferometer for the analysis of Fast Events, GRD1-2001-41824) is currently running which aims at simplifying the above pulse technique, which was only a demonstration of the principle by CSL and LCFIO.

The first phase of the project consists in two study axes. The first one is the development of a YAG Q-switch laser giving two pulses with two different energies, variable delay and 25 Hz repetition rate. This

characteristics will allow to no longer consider external devices (two expensive Pockels cells) for the energy balance between the recording and the readout pulses.

This task has been handled by INNOLAS company.

The second axis is the study and optimization of several holographic heads derived from the scheme presented in section 3.2, but bringing important modifications for better performances. Also, new PRCs (semiconductor family : CdTe, GaAs...) are studied that can work at the fundamental line of YAG lasers (1064 nm). The best working systems have been combined into a modular holographic head, e.g. we have the choice between operations at two different wavelengths.

This task has been carried out by the CENTRE SPATIAL DE LIEGE, the LABORATOIRE CHARLES FABRY DE L'INSTITUT D'OPTIQUE and the INSTITUT FUR TECHNISCHE OPTIK.

After these two segments have been finalized, an industrial prototyping phase is carried out to merge both into a single entity. This has been carried out by OPTRION for the optics part and by DANTEC ETTEMEYER for the software and the ensemble.

4.1 Development of holographic head.

One main concern is the phase quantification technique which has to be adapted to the use of pulse laser. We have considered a modified two-camera system which allows to obtain two phase-shifted interferogram of the same displacement. The new system is a completely passive one, which no longer requires the third Pockels cell of the early experiment (section 3.2). It is based on the anisotropy of diffraction configuration, whereas previously we used an isotropy of diffraction configuration. With this new scheme we have natural polarization of light separation after the crystal which can be directly used to shift the phase between the two interfering fields.

Figure 12 shows a sketch of the system with 2 camera and the anisotropy of diffraction.

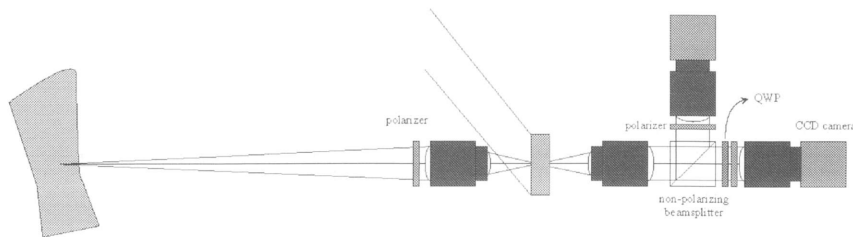

Figure 12. Sketch of the holographic head based on anisotropy of diffraction and 2-camera system for phase-shifting. The phase shift of 90° between the 2 cameras is introduced by the quarter-wave plate in one arm.

Figure 13 (a) and (b) shows the 2 interferograms with the phase shift and figure 13(c) shows the phase image computed. In order to perform this calculation, the average intensity of the image has to be captured first and once for all for a given object and for both cameras. These results have been obtained in first demonstration laboratory experiments with a continuous Nd:YAG laser, here in the green with a BSO crystal.

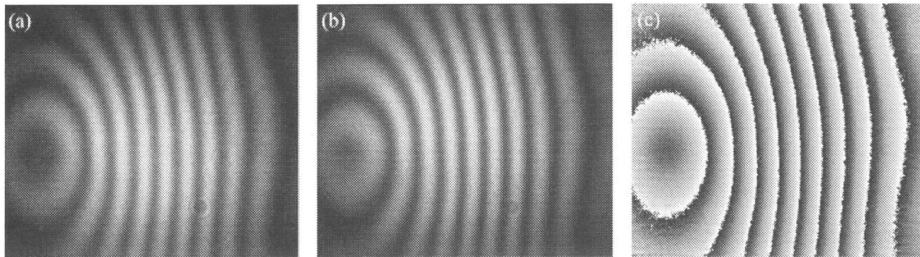

Figure 13: (a), (b) Interferograms captured by both cameras. (c) Resulting phase image.

4.2 Industrial prototyping

The second phase of the project combines both the laser and holographic heads resulting from the first phase. Figure 14 shows a CAD image and a picture of the holographic head (as designed and built by OPTRION) which is attached to the laser structure.

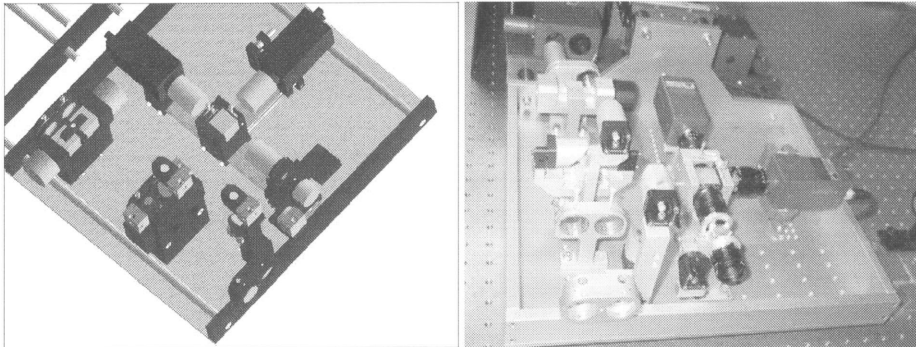

Figure 14 (a) CAD image of the PHIFE holographic head, (b) Picture of the industrial holographic head attached to the laser structure (seen in the back).

The remaining part of the work consists in integrating the software and the ensemble in a ruggedized housing for on-field avoiding dusts during on-field demonstrations.

4.3 Industrial tests

The third phase of the project is the demonstration of this instrument in industrial applications : vibrations measurement in the fields of automotive, aeronautical and consumer apparatus and aeronautical studies in windtunnels.

The first demonstration tests have been carried out with the industrial prototype on different study cases concerning solid objects. These tests have been coordinated by the company AMITRONICS.

We have started with vibrations on different objects and different excitation tools. We will show here only a few examples. Figure 15 show interferograms of different modes of an electronic board attached to a shaker. What is displayed here is only the image with one of the two cameras.

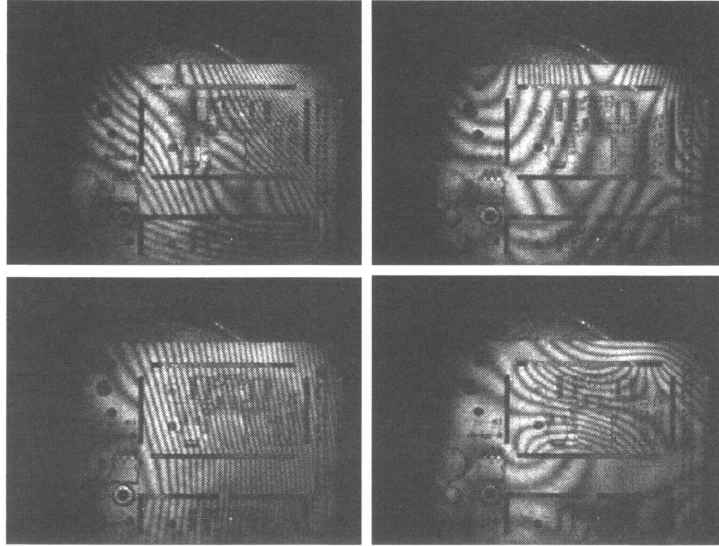

Figure 15. Vibration mode shapes of an electronic circuit excited with a shaker.

A next step of the project will be the evaluation of amplitude and phase of vibration with a multipulse technique like the one described earlier. The images above are only a first demonstration of the interferogram quality and resolution that the system can capture. These results have been obtained in the infrared with the AsGa crystal.

Another example is the one of shocks. Figure 16 shows a series of images obtained at with the double pulse sequence at 25 Hz repetition rate. The object is a steel plate hanged by 2 corners (free-free). A hammer excites the plate. Before hammering, no movement is seen (image top-left). After the excitation, different modes or combination of modes are seen randomly.

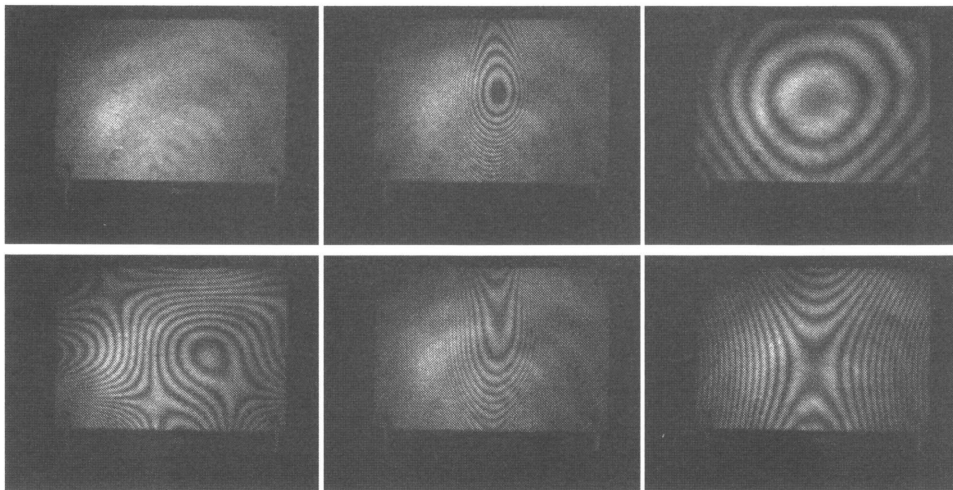

Figure 16. Different mode shapes appearing after a hammer shock on a steel plate.

4.4 Concluding remarks

These results show that a holographic head with photorefractive crystal coupled to a double pulse YAG Q-switch laser working with a high repetition rate constitutes a breakdown in the field of vibration and shock analysis, in term of high resolution and fast holographic recording and readout process.

5 Conclusion

We have presented a review of different holographic interferometry systems based on photorefractive crystals as self-processable and continuously reusable holographic media.

In addition to these interesting features, they allow very high accuracy and image resolution compared to other full-field systems based on speckle interferometry.

A first system based on stroboscopic technique allows the high resolution visualization of mode shapes for object undergoing sinusoidal excitation.

A second range of techniques is that using pulse lasers. A first system has been developed and use a single pulse laser. It allowed us to demonstrate the efficiency of a multipulse technique and to consider further developments in the frame of an EC-funded project PHIFE. The latter has the aim to obtain a full-field high resolution system working at high repetition rate. Combined with a 4-pulse technique, it will allow fast measurement of amplitude and phase of vibrations.

6 References

- [1] Ed. P.K. Rastogi, *Holographic interferometry : Principles and Methods*, Springer Series in Optical Sciences 68, Springer-Verlag, Berlin, 1994.
- [2] Th. Kreis, *Holographic Interferometry : Principles and Methods.*, Akademie Verlag, Berlin, 1996
- [3] D.I. Farrant, G.H. Kaufmann, J.N. Petzing, J.R. Tyrer, B.F. Oreb, D. Kerr, *Measurement of transient deformations with dual-pulse addition electronic speckle pattern interferometry*, Appl. Opt. **37**, p.7259-7267 (1998).
- [4] Ph. Fröning, G. Pedrini, H.J. Tiziani, F. Mendoza Santoyo, *Vibration mode separation of transient phenomena using multi-pulse digital holography*, Opt. Eng. **38**, p. 2062-2068 (1999).
- [5] M.P. Georges, Ph. C. Lemaire, *Real-time stroboscopic holographic interferometry using sillenite crystals for the quantitative analysis of vibrations*, Opt. Com. **145**, p.249-257 (1998)
- [6] L. Labrunie, G. Pauliat, G. Roosen, J-C. Launay, *Simultaneous acquisition of $\pi/2$ phase-stepped interferograms with a photorefractive $Bi_{12}GeO_{20}$ crystal : application to real-time double-pulse holography*, Opt. Lett. **20** (15), p. 1652-1654 (1995)
- [7] L. Labrunie, G. Pauliat, J-C. Launay, S. Leidenbach, G. Roosen, *Real-time double exposure holographic phase-shifting interferometer using a photorefractive crystal*, Opt Comm. **140**, p. 119-127 (1997).
- [8] Ed. P. Günter and J.-P. Huignard, *Photorefractive Materials and their applications : Survey of Applications*, Topics in Applied Physics **62**, Springer-Verlag, Berlin, 1989.
- [9] M.P. Petrov, S.I. Stepanov and A.V. Khomenko, *Photorefractive crystals in Coherent Optical Systems*, Springer Series in Optical Sciences **59**, Springer-Verlag, Berlin, 1991.
- [10] M.P. Georges and Ph.C. Lemaire, *Phase-shifting real-time holographic interferometry that uses bismuth silicon oxide crystals*, Applied Optics **34**, p. 7497-7506 (1995)

- [11] M.P. Georges and Ph.C. Lemaire, *Real-time holographic interferometry using sillenite photorefractive crystals. Study and optimization of a transportable set-up for quantified phase measurements on large objects*, Appl. Phys. B, **68**, p. 1073-1083 (1999)
- [12] J.-P. Huignard, J.-P. Herriau and T. Valentin, *Time average holographic interferometry with photoconductive electrooptic $Bi_{12}SiO_{20}$ crystals*, Appl. Optics **16**, p. 2796-2798 (1977)
- [13] A. Marrakchi, J.-P. Huignard and J.-P. Herriau, *Applications of phase conjugation in $Bi_{12}SiO_{20}$ crystals to mode pattern visualization of diffuse vibrating structures*, Optics Comm. **34**, p. 15-18 (1980)
- [14] Marc P. Georges, Véronique S. Scaufaire, Ph. C. Lemaire, *Compact and portable holographic camera using photorefractive crystals. Application in various metrological problems*, Appl. Phys. B **72**, p. 761-765 (2001)
- [15] S. Nakadate, H. Saito and T. Nakajima, *Vibration measurement using phase-shifting stroboscopic holographic interferometry*, Optica Acta **33**, p. 1295-1309 (1986)
- [16] Marc P. Georges, Gilles Pauliat, Philippe C. Lemaire, Gérald Roosen, *Interférométrie holographique avec cristaux photoréfractifs en régime impulsif. Développements et résultats préliminaires*, 10e séminaire SFO/HOLO3 : Nouveaux moyens optiques pour l'industrie, Bordeaux, France, 18-19 November 1998.