

- Partially based on the paper ‘Gravitational Lenses’ by Sjur Refsdal and Jean Surdej, published in *Rep. Prog. Phys.* **56** (1994) 117-185

Sjur Refsdal 1935-2009

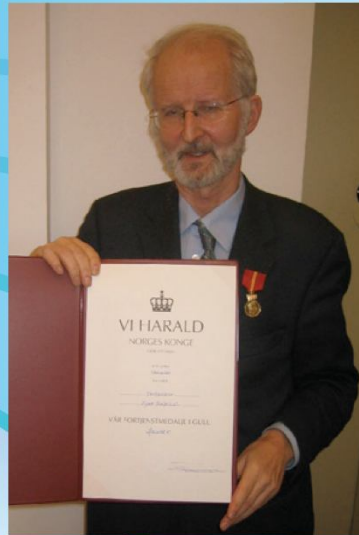

Photo (University of Oslo): Prof. Refsdal after being awarded the King's Medal of Merit in Gold.

SJUR REFSDAL 1935-2009 (by prof. Per Barth Lilje)

It is with deep regret that the Institute of Theoretical Astrophysics has announced the death of Professor Sjur Refsdal on Thursday, the 29th of January, 2009 at the age of 73.

Sjur was born in Oslo on the 30th of December 1935. He received the master degree from the Physics Department of the University of Oslo in 1962. He was at NORDITA, Copenhagen 1962 – 1963 and held a fellowship at the Institute of Theoretical Astrophysics, University of Oslo 1963 – 1966. From 1967 to 1970 he was associate professor at the University of Nebraska; in 1970 he returned briefly to Oslo to defend the degree of dr. philos. at the University of Oslo. In the same year he was appointed professor at the University of Hamburg, Germany, which became his working place until he retired in 2001.

Throughout his career he kept very close contact with the Institute of Theoretical Astrophysics. He held an adjunct professorship at the Institute from 1991 to 2001. When he retired in Hamburg in 2001, he moved to Oslo and continued working as an emeritus professor at our Institute until the incurable progressive nerve disease that he suffered from in the later years made it impossible for him to get to his office almost two years ago. He was a member of the Norwegian Academy of Science and Letters, and in the academic year 1997/1998 he led (together with Professor Rolf Stabell) a research program at the Centre for Advanced Study at the Norwegian Academy of Science and Letters. In 2005 he was awarded The King's Medal of Merit in Gold.

In the period 1964-1970 Sjur wrote a series of six classical papers on gravitational lensing, really laying the foundation of this field long before the first gravitational lens was found in 1979. Already in 1964 he showed how the gravitational lens effect can be used to determine the expansion rate of the universe (the Hubble constant) and the masses of galaxies. Together with students at the Institute of Theoretical Astrophysics in the mid-1960s he also did pioneering numerical studies of the evolution of cosmological models with a cosmological constant. For several years Sjur worked on the theory of stellar interiors and stellar evolution, especially with colleagues in Hamburg and Oslo, producing many well quoted papers on later stages of stellar evolution. After the discovery of the first gravitational lens in 1979, he was quick back to developing their theory further. Already in the same year, he produced together with his Ph.D. student Kyongae Chang a seminal paper predicting the phenomenon of microlensing, a phenomenon that was observationally confirmed in 1989.

2. Gravitational lenses

List of contents:

1. INTRODUCTION

2. HISTORICAL BACKGROUND

3. ATMOSPHERIC LENSING

4. PHYSICAL BASIS OF GRAVITATIONAL LENSES

2. Gravitational Lenses: 1. INTRODUCTION

The first example of a gravitational lens system, the doubly imaged quasar Q0957+561 A and B, was serendipitously identified by Walsh, Carswell and Weymann in 1979. Since then, gravitational lensing has become a very "hot" topic in astronomical research. Several hundreds of new lenses have been found and studied during the last decades. Furthermore, theoretical modeling of these enigmatic objects has already provided us with important astrophysical and cosmological information, not attainable by any other standard methods. This series of courses summarizes the history and the present status of the observations and of our physical understanding of gravitational lensing effects. The general layout of the lectures is organized as follows: we first briefly review the historical background of gravitational lenses in chapter 2. The reader will note with some interest that, unlike most of the other astrophysical discoveries made during the XXth century, the basic physics of gravitational lenses was understood well before the first example was actually found. Then a brief discussion of atmospheric lensing, which presents many analogies with gravitational lensing, follows in chapter 3. In chapter 4, we describe the basic principles of gravitational lensing. We derive there the form of the lens equation and by making use of the Einstein deflection angle, we determine the expression of the image magnification (or amplification). For didactical purposes, we show in chapter 5 how to derive the shape of optical lenses in order to simulate and to better understand the image properties of distant sources which are gravitationally lensed by various types of axially symmetric mass distributions. The optical setup of our gravitational lens experiment is presented at the end of that chapter. In chapter 6, we discuss in detail the image properties of a distant source resulting from the gravitational deflection of light rays passing near a black hole, a singular isothermal sphere, a spiral galaxy seen face on, a uniform disk of matter as well as a truncated one.

2. Gravitational lenses

5. THE OPTICAL GRAVITATIONAL LENS EXPERIMENT

6. GRAVITATIONAL LENS MODELS

7. DIDACTICAL EXPERIMENTS

8. OPTICAL DEPTH FOR LENSING AND SOME OBSERVATIONAL ASTROPHYSICAL RESULTS

9. COSMOLOGICAL AND ASTROPHYSICAL APPLICATIONS

2. Gravitational Lenses:

1. INTRODUCTION:

We first establish a sufficient condition for an observer to see multiple images from a distant source. In case of perfect alignment between an observer, a symmetric deflector and a source, the resulting lensed image consists of a ring (the so-called 'Einstein ring') and we show how the expression of its angular diameter relates to physical parameters. By means of ray tracing and bending angle diagrams, of the optical gravitational lens experiment and by directly solving the lens equation, we study the image properties associated with the lens models mentioned above.

The concept of 'caustics' emerges naturally from the ray tracing diagram associated with the spiral galaxy model and we then show with the help of our optical lens experiment how all image configurations observed in the Universe may be simply understood in terms of the relative location of the observer (or equivalently of the source) with respect to the caustics associated with a singular asymmetric lens. Some of the most promising cosmological and astrophysical applications of gravitational lensing are addressed in section 9. We first describe the independent determination of the Hubble parameter H_0 via the measurement of the time delay Δt between the observed light curves of multiply imaged extragalactic sources. The possibility of weighing the mass of lensing galaxies and galaxy clusters from the observation of multiply imaged quasars, arcs and arclets is also briefly described.

What is a mirage?

A mirage is an optical illusion ...

... whose cause is real!

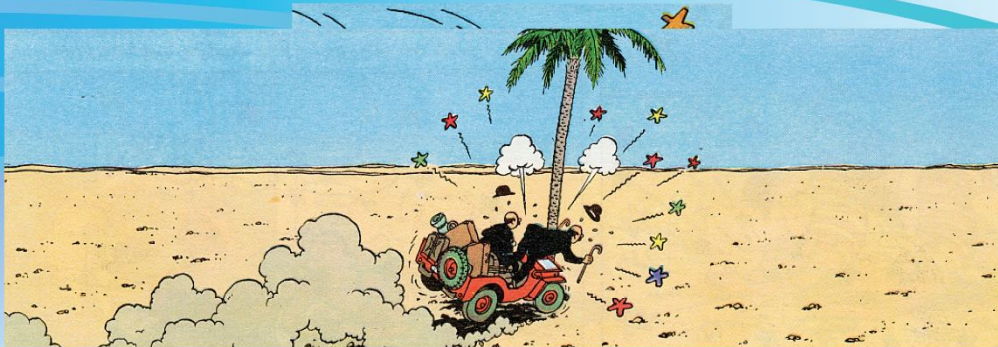

© Hergé

© Hergé

What is a mirage?

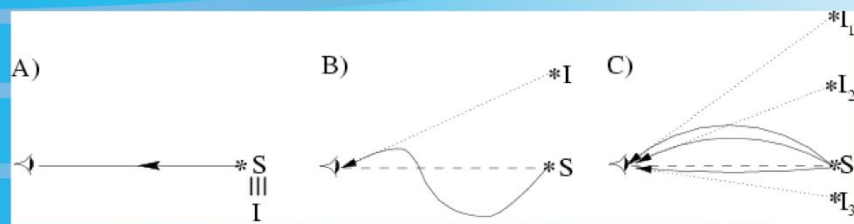

1. An image is always seen along the **direction** of the incoming light ray
 2. A **mirage** is formed when the incoming light rays do not propagate along **straight lines**
 3. Light may propagate along different trajectories with propagation **times** which are always **extrema** (Fermat Principe)
- possible formation of multiple images



2. Gravitational lenses

PREAMBLE:



Schematic view of the N-S arm of the Very Large Array (VLA) in Socorro (New Mexico), in the A configuration. The second last antenna, at an approximate distance of 10 km, is not resolved with the naked eye (January 1988).

2. Gravitational Lenses: PREAMBLE ... about metamorphosed views of our local ground-based world! In January 1988, J. Surdej visited the VLA (Very Large Array) near Socorro (New Mexico) in order to map at 6 cm, in the A configuration, the new gravitational lens system UM 673 that had been identified at optical wavelengths by the Liège group of observers, in collaboration with astronomers from Hamburg and ESO.

During the day time, altogether with a radio astronomer from MIT, Chip Cohen, as we were walking around the VLA, we were struck to see that along the N-S arm, the second last antenna, that we could not resolve with our naked eyes, did actually look brighter than the third and maybe even the fourth last ones (see the above Figure). What was the reason? Several possible interpretations came of course to our mind:

- i) was the second last antenna differently oriented with respect to the other ones? Replacing those antennas by quasars, we would have invoked ‘beaming’, i.e. a relativistic jet oriented very near to our line-of-sight as a possible mechanism to boost the apparent luminosity of the second last quasar ...
- ii) or could it be that the second last quasar (antenna) was just intrinsically brighter than the other ones, i.e. it was a member of the class of astrophysical monsters?
- iii) Another possibility, yet, is that the second last antenna was out of the rails, i.e. that the second last quasar is not located at its cosmological distance (cf. the redshift controversy).

We finally went to the control room of the VLA where we could borrow from the operator a pair of binoculars. We were then very much surprised to see that the second last antenna was actually made of two distinct antenna images and that the apparent brightening of the second (unresolved) last antenna was actually due to an amplification (or magnification when the images are resolved) by atmospheric lensing effects (cf. next figure).

2. Gravitational lenses

PREAMBLE:

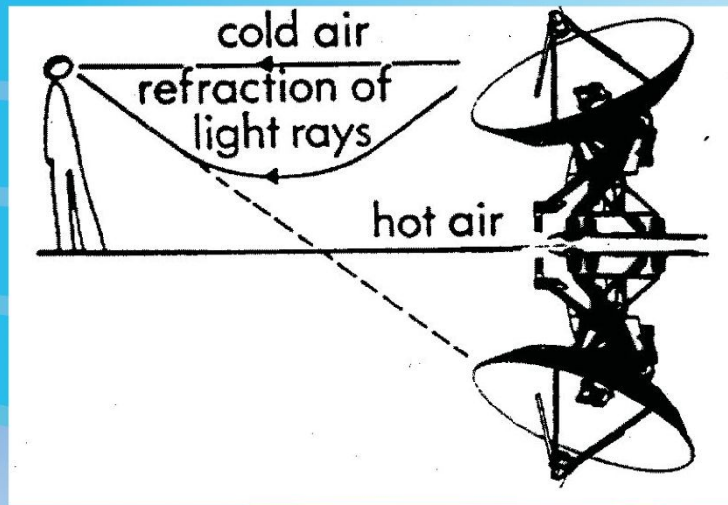

Due to atmospheric lensing, the second last antenna was doubly imaged and, while it was unresolved with the naked eye, it appeared brighter than the third and fourth last antenna.

2. Gravitational Lenses:

PREAMBLE ... about metamorphosed views of our local ground-based world

Unfortunately, on that particular day, none of us had a photographic camera to record what we saw through the binoculars. But one year later, while still visiting the VLA, other intriguing views of the VLA arose. These will be shown during to-day's lecture. The similarities existing between atmospheric and gravitational lensing will become even more obvious!

2. Gravitational lenses

1. INTRODUCTION:

2. HISTORICAL BACKGROUND:

- "Do not Bodies act upon Light at a distance, and by their action bend its Rays; and is not this action strongest at the least distance?"

Isaac Newton, 1704

- J. Soldner (1804): $\alpha = 2GM_{\odot} / (c^2 R_{\odot}) \sim 0.875''$

- XVIIIth and XIXth centuries

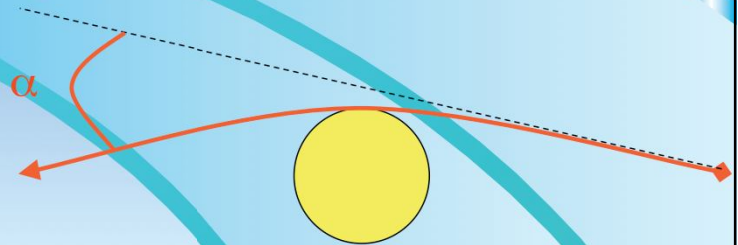

2. Gravitational Lenses:

2. HISTORICAL BACKGROUND:

Considering that light may be composed of elementary constituents, Newton suggested as early as 1704 that the gravitational field of a massive object could possibly bend light rays, just as the trajectory of material particles. Laplace also made independently this suggestion. About one hundred years later, the astronomer J. Soldner (1804) from Munich Observatory found that, in the framework of Newtonian mechanics, a light ray passing near the limb of the Sun should undergo an angular deflection of $0.875''$. However, because the wave description of light prevailed during the whole XVIIIth and XIXth centuries, neither the conjecture of Newton, nor the result of Soldner were ever taken seriously. Using the equivalence principle, Einstein (1911) rederived Soldner's result.

2. Gravitational lenses

2. HISTORICAL BACKGROUND:

- Einstein (1911, 1915): $\alpha = 4GM_{\odot} / (c^2 R_{\odot}) = 1.75''$, (2.1)
- Dyson et al. (1920): 20-30% uncertainty; Fomalont and Sramek (1975a, b), Robertson et al. (1991): $\ll 1\%$ uncertainty

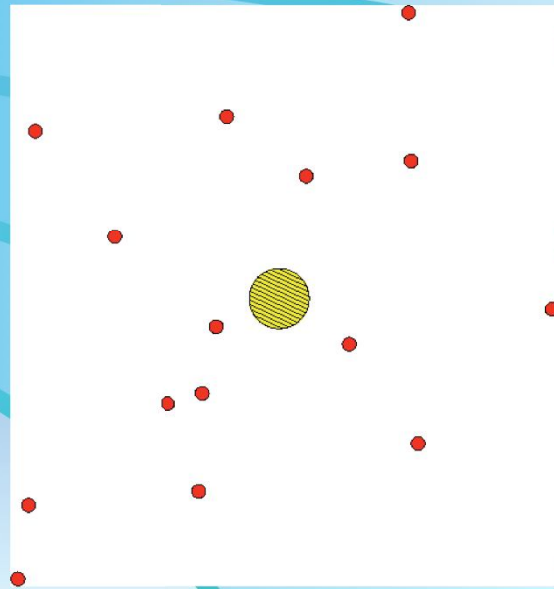

2. Gravitational Lenses: 2. HISTORICAL BACKGROUND

During the elaboration of his theory of General Relativity, Einstein predicted that a massive object curves the space-time in its vicinity and that any particle, massive or not (cf. the photons), will move along the geodesics of this curved space. He predicted in 1915 that a light ray passing near the solar limb should be deflected by an angle equal to

$$\alpha = 4GM_{\odot} / (c^2 R_{\odot}) \sim 1.75'', \quad (2.1)$$

where G stands for the gravitational constant, c for the velocity of light and M_{\odot} , R_{\odot} for the mass and the radius of the Sun, respectively. As we may note, this deflection angle turns out to be exactly twice the value derived by Soldner. Using photographs of a stellar field taken during the solar eclipse in May 1919, and six months apart, Eddington and his collaborators (see Dyson et al. 1920) were able to confirm, within a 20-30% uncertainty, the deflection angle predicted by Einstein. This was not only a triumph for General Relativity but also a marvelous confirmation of the concept that light rays may undergo deflections in gravitational fields. Let us note that this uncertainty has been presently reduced to much less than 1% thanks to radio interferometric observations of quasi-stellar sources (Fomalont and Sramek 1975a, b, Robertson et al. 1991) and independent measurements in the solar system.

2. Gravitational lenses

2. HISTORICAL BACKGROUND:

- Eddington (1920) ... but see Einstein (1911)
- Sir Oliver Lodge (1919)
- E.B. Frost (1923)

A point mass object consists of a very imperfect, although achromatic, lens!

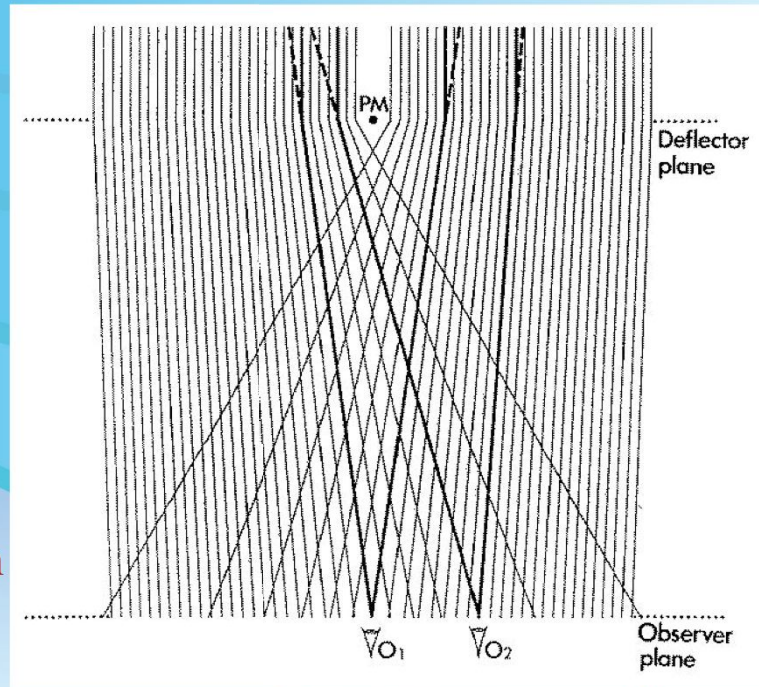

2. Gravitational Lenses: 2. HISTORICAL BACKGROUND

It seems that Eddington (1920) was the first to propose the possible formation of multiple images of a background star by the gravitational lensing effect of a foreground one (Einstein in 1911 had also done so with the wrong formula). Let us note however that Sir Oliver Lodge (1919) had already characterized massive objects like the Sun to be imperfect focusing lenses since they had no real focal length; the light from a background object being mainly concentrated along a focal line of "infinite" length. In 1923, E.B. Frost, then director of the Yerkes Observatory, initiated a program to search for multiply imaged stars in the Galaxy but it seems that these observations never really took place.

2. Gravitational lenses

2. HISTORICAL BACKGROUND:

- O. Chwolson (1924)
- Etherington (1933)
- Einstein (1936)
- Zwicky (1937a, b) '*... the probability that galactic nebulae which act as gravitational lenses will be found becomes practically a certainty.*'
- Link (1937)

2. Gravitational Lenses:

2. HISTORICAL BACKGROUND:

O. Chwolson (1924) suggested that, in case of a perfect alignment between an observer and two stars located at different distances, the former should see a ring shaped image of the background star around the foreground one. Furthermore, following Etherington who demonstrated in 1933 that gravitational lensing preserves the specific intensity (or surface brightness) of electromagnetic waves, it is then straightforward to establish that the amplification of a source is just equal to the 'magnification' ratio of its image size (cf. the solid angle subtended by the "Chwolson" ring) to that it would have if no lensing was taking place (i.e. the solid angle subtended by the real stellar disk). Independently, Einstein (1936) rediscovered the major characteristics (double images, the "Chwolson" ring usually referred to as the "Einstein" ring, etc.) of a star lensed by another one but he was very skeptical as to the possibility of observing this phenomenon among stars. Remember that in 1911, Einstein had already established such a theory, although with a wrong value for the deflection angle, i.e. using a formula similar to that of Soldner. Zwicky (1937a, b) was the first to realize the very high probability of identifying a gravitational lens mirage, i.e. made of several distinct images resolvable from the ground, among extragalactic objects (see the figure on the next page). He even proposed to use galaxies as natural cosmic telescopes to observe otherwise too faint and distant background objects. He also emphasized the possibility of weighing the mass of distant galaxies by simply applying gravitational lens optometry and, in addition, to test the theory of general relativity. Link (1937) has thoroughly discussed the effects of gravitational lensing expected from such galaxies. In 1937, Zwicky stated that '*... the probability that galactic nebulae which act as gravitational lenses will be found becomes practically a certainty*', and he was therefore very much surprised to note some 20 years later that no such lensing effects had yet been found with the 200 inch Palomar telescope (Zwicky 1957).

2. Gravitational lenses

2. HISTORICAL BACKGROUND:

- Zwicky (1957)

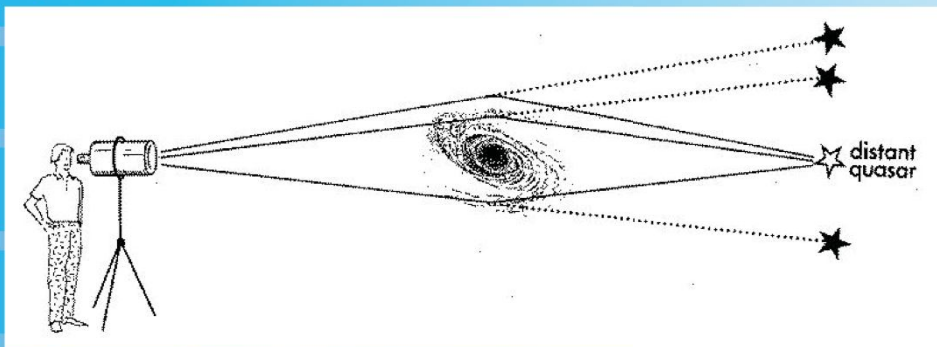

An observer sees the lensed images of a distant quasar along the directions of light rays deflected by a massive intervening galaxy.

- Klimov (1963; galaxy-galaxy lensing), Liebes (1964; star-star lensing) and Zel'dovich (1964) and Refsdal (1964a, b, 1966a; cosmological applications of gravitational lensing)

2. Gravitational Lenses: 2. HISTORICAL BACKGROUND

After an inter-regnum of nearly a quarter of a century, the interest for the theory of gravitational lenses was revived by Klimov (1963; galaxy-galaxy lensing), Liebes (1964; star-star lensing) and Zel'dovich (1964) and Refsdal (1964a, b, 1966a; cosmological applications of gravitational lensing). Some of these proposed applications were particularly promising because of the recent discovery of quasars by Schmidt (1963). It would indeed be much easier to prove the lensing origin of multiple QSO (Quasi Stellar Object) images rather than that of extended and diffuse galaxy images, since the former ones consist of very distant, luminous and star-like appearing objects whereas the latter ones could hardly be distinguished from interacting galaxies. Based on the great similarity between the spectra of quasars and nuclei of Seyfert 1 galaxies, Barnothy (1965) even proposed that high redshift quasars could actually be the lensed images of distant Seyfert 1 galaxy nuclei. On a low level of activity, theoretical work continued through the seventies. Refsdal (1965, 1970) and Press and Gunn (1973) discussed problems on lens statistics, Bourassa and Kantowski (1975) considered extended non-symmetric lenses (see also Sanitt 1971 and Bourassa et al. 1973) and Dyer and Roeder (1972) derived a distance-redshift relation for the case of inhomogeneous universes. In spite of clear theoretical predictions, the interest from observers was rather low and no systematic search for lenses was initiated. Forty two years after Zwicky's prediction, the dream of some astronomers finally became reality: Walsh, Carswell and Weymann discovered serendipitously in 1979 the first example of a distant quasar (0957+561), multiply imaged by a foreground massive lensing galaxy. Following this pioneering detection, the levels of observational as well as theoretical activities have increased dramatically: up to now, more than 4000 scientific publications have been written on the subject of gravitational lensing (GL). A non exhaustive bibliography on GL is accessible via internet at the URL: http://vela.astro.ulg.ac.be/grav_lens/.

2. Gravitational lenses

2. HISTORICAL BACKGROUND:

- Schmidt (1963)
- Barnothy (1965)
- Refsdal (1965, 1970) and Press and Gunn (1973)
- Bourassa and Kantowski (1975), Sanitt (1971) and Bourassa et al. (1973)
- Dyer and Roeder (1972)
- Walsh, Carswell and Weymann (1979): 0957+561
- > 4000 scientific publications (non exhaustive bibliography available on the web at the URL: http://vela.astro.ulg.ac.be/grav_lens/)
- Schneider, Ehlers and Falco (1992)

2. Gravitational Lenses:

2. HISTORICAL BACKGROUND:

As shown in this course, gravitational lensing does constitute a new and very important branch of extragalactic astronomy. We refer to Schneider, Ehlers and Falco (1992) for a more detailed account on the history of gravitational lensing, as well as for a more complete and general presentation of this subject. Before studying the bending of light rays in the gravitational field of massive objects, let us first describe a better known and somewhat related phenomenon, i.e. the bending of light rays by atmospheric lensing.

2. Gravitational lenses

3. ATMOSPHERIC LENSING:

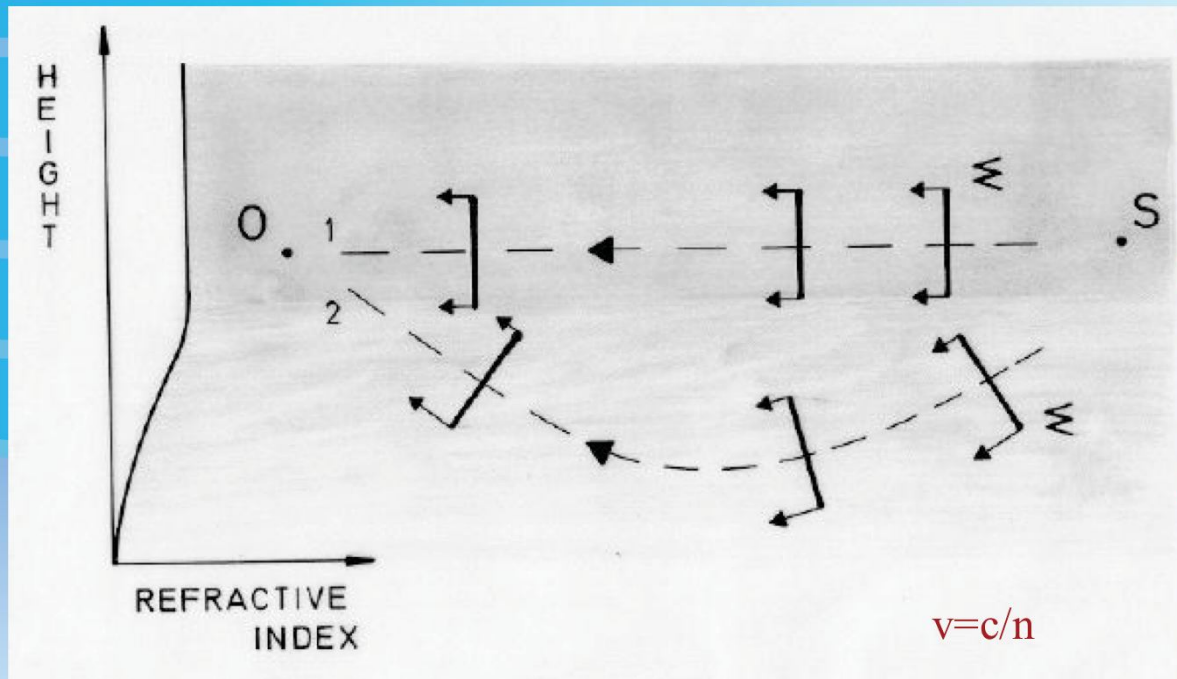

2. Gravitational Lenses:

3. ATMOSPHERIC LENSING:

It is interesting to note that gravitational fields in the Universe deflect light rays in a way that is very similar to the refraction properties of the lower atmospheric air layers: because of significant temperature and density gradients near the ground, light rays often undergo significant bendings. In the above figure, a distant source S emits a spherical wavefront. Two very small plane waves Σ , approximating parts of the spherical one, are propagating towards the observer O . Also represented are the velocity vectors of light on both sides of the plane waves. Because in our example, the refractive index gets higher from the bottom up to a certain height, light velocity is also higher near the ground. As a result, the lower plane wave (2) tilts as it propagates towards the observer. The upper one (1) propagates through air layers having a constant refractive index; it goes straight. The observer sees of course the light rays arriving to him perpendicularly to the plane waves and, under certain conditions (cf. a sufficiently high gradient characterizing the refractive index), he may see multiple images of the distant source S .

2. Gravitational lenses

3. ATMOSPHERIC LENSING:

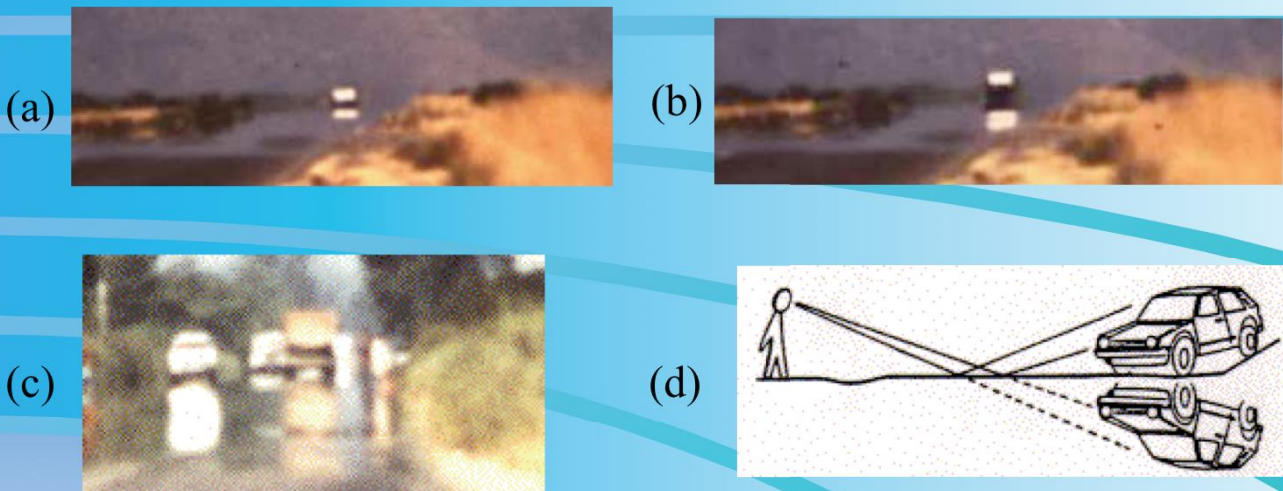

Atmospheric lensing: (a) and (b) illustrate double images of a distant, approaching, truck and (c) of a distant car along the North Panamericana highway between the towns of Pichidanguí and La Serena (Chile, 2 December 1987). (d) gives a schematic view of double light rays for the case of an inferior atmospheric mirage.

2. Gravitational Lenses:

3. ATMOSPHERIC LENSING:

Figures (d) and (f) give a schematic representation of the light ray paths when the ground turns out to be somewhat hotter than the ambient air. Because air refraction always leads to a bending of light rays towards regions of colder air, the formation of one lower, inverted and somewhat deformed image of a distant source may result (cf. the distant truck and car in figures (a), (b) and (c)). Similarly, upper mirages may form when the temperature gradient is reversed (cf. Figs. (g) and (h)*). In order to understand in more details the light propagation across a plane parallel atmosphere whose refractive index is affected by a vertical gradient dn/dz , we may apply Fermat's principle according to which the path(s) followed by light between two given points is that (or those) which correspond(s) to an extremum in the propagation time, i.e.,

$$\delta \left(\int_0^s (1/v) ds' \right) = 0, \quad (3.1)$$

where $ds' = (dx^2 + dz^2)^{1/2}$ represents an infinitesimal element along the light trajectory and $v = c/n$, the velocity of light in the medium with a refractive index $n(z)$ (see Fig. on page 16).

* This may happen the morning when the ground is colder than the air above which is heated by the rising sun.

2. Gravitational lenses

3. ATMOSPHERIC LENSING:

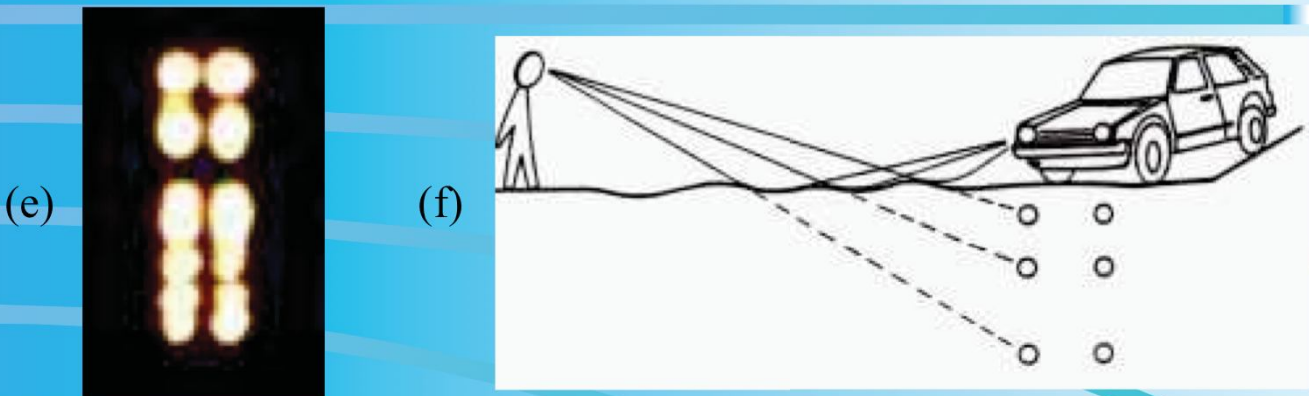

Atmospheric lensing: (e) represents the multiple car lights of a distant vehicle along the US 60 road between Magdalena and Datil in New Mexico on the night of 19 January 1989. The distance between the car and the observer was estimated to be 10 miles. (f) gives a schematic representation of the light rays from a distant car when the ground turns out to be somewhat hotter than the ambient air. Because air refraction always leads to a bending of light rays towards regions of colder air, several lower and somewhat deformed images of a distant car may result.

2. Gravitational Lenses:

3. ATMOSPHERIC LENSING:

It is easy to show, by means of the Euler-Lagrange equation (see below), that the variational equation (3.1) simply reduces to Descartes' law

$$n(z) \cos(i(z)) = K, \quad (3.2)$$

where K is a constant and $i(z)$ represents the angle between the tangent to the light ray and the horizontal direction. Indeed, Eq. (3.1) may be rewritten as

$$\delta \left[\int n(z) \sqrt{1 + \left(\frac{dx}{dz} \right)^2} dz \right] = 0,$$

and by analogy with the variational Lagrange equation

$$\delta \left[\int L(q, \dot{q}, t) dt \right] = 0,$$

which solution is given by solving the equation

$$\frac{d}{dt} \left(\frac{\partial L}{\partial \dot{q}} \right) - \frac{\partial L}{\partial q} = 0, \quad \text{we obtain} \quad \frac{d}{dz} \left(n(z) \frac{(dx/dz)}{\sqrt{1 + (dx/dz)^2}} \right) = 0$$

and finally, after several simplifications (cf. $\text{tg}(i) = dz/dx$), Eq. (3.2).

2. Gravitational lenses

3. ATMOSPHERIC LENSING:

(g)



(h)



Atmospheric lensing: (g-h) correspond to two different views of the north-south arm of the Very Large Array at the National Radio Astronomical Observatory (Socorro, New Mexico) as seen in the early morning of 17 January 1989.

2. Gravitational Lenses:

3. ATMOSPHERIC LENSING:

It is then straightforward to derive the expression for the small angle increment di of the ray between two neighbouring points whose abscissae are x and $x+dx$. For a small but finite value of dx and developing the expression $d(n(z) \cos(i)) = 0$, we do find with a good approximation that

$$di = \frac{(dn/dz)dx}{n(z) + (dn/dz)\tan(i)dx} \approx \frac{(dn/dz)dx}{n(z)} \quad \text{and} \quad \alpha = \int di \approx \int \frac{(dn/dz)dx}{n(z)}. \quad (3.3)$$

This relation is very useful in order to construct numerically the trajectory of light rays across an atmosphere (i.e. $\alpha = \int di$) characterized by a refractive index distribution $n(z)$. In doing so (cf. the simulations to be shown during the present lecture), one finds that under special circumstances (cf. specific refractive index distributions $n(z)$, source distance, etc.) there may exist several geodesics between the source and the observer, resulting in the possible formation of multiple images. Because surface brightness, or specific intensity, is preserved in atmospheric lensing, just as in the case of gravitational lensing, amplification of the lensed images will be proportional to their solid angle compared to that of the unlensed source. Therefore, in addition to affecting significantly our view (image deformation, multiplication, etc.) of distant resolved Earth-sources, atmospheric lensing is also often responsible for the light amplification of distant unresolved objects located along straight and long roads or across flat countrysides.

2. Gravitational lenses

3. ATMOSPHERIC LENSING:

Simulations!

$$\delta \left(\int_0^s (1/v) ds' \right) = 0. \quad (3.1)$$

$$n(z) \cos(i(z)) = K, \quad (3.2)$$

$$di = \frac{(dn/dz)dx}{n(z)} \text{ and } \alpha = \int di = \int \frac{(dn/dz)dx}{n(z)} = \int \frac{d \ln(n(z))}{dz} dx \quad (3.3)$$

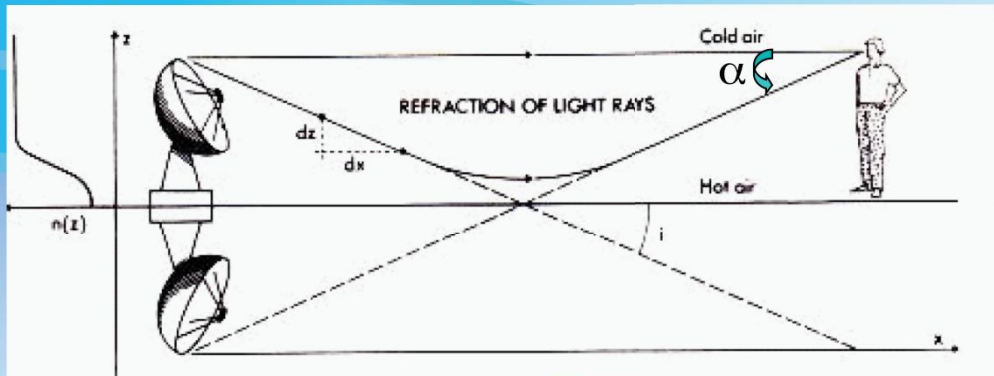

Formation of an atmospheric mirage across an atmosphere characterized by a refractive index distribution $n(z)$, as shown along the left horizontal axis.

2. Gravitational Lenses:

3. ATMOSPHERIC LENSING:

It is also interesting to note that because of the difference in the geometric lengths and light velocities ($c/n(z)$) along two geodesics, there will generally be a delay between the arrival times of a signal from the source (cf. a hypothetical light flash) as seen by a distant observer. This time delay depends of course on the refractive index distribution $n(z)$ and also on the absolute distance between the source and the observer.

As we shall see in the remainder, there exist quite a few other similarities between atmospheric and gravitational lensing.

2. Gravitational lenses

3. ATMOSPHERIC LENSING:



2. Gravitational lenses

4. PHYSICAL BASIS OF GRAVITATIONAL LENSES:

4.1. General remarks:

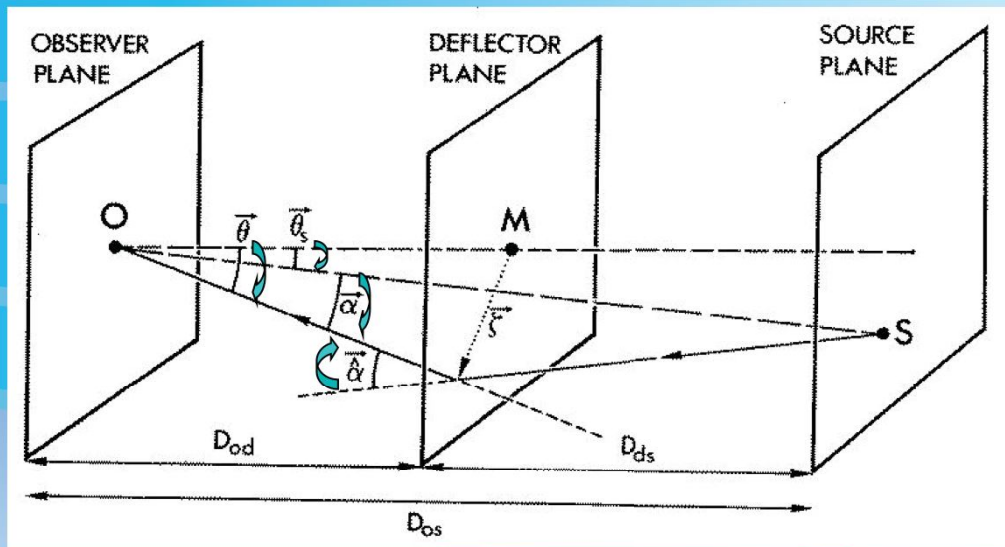

Geometrical quantities characterizing the deflection of a light ray by a point mass lens (M).

2. Gravitational Lenses:

4. PHYSICAL BASIS OF GRAVITATIONAL LENSES; 4.1. General remarks:

The physical basis of gravitational lensing essentially consists in the deflection of light, and electromagnetic waves in general, in gravitational fields as predicted by Einstein's theory of General Relativity. In the regime of small deflection angles and of weak gravitational fields, which are of practical interest to us here, the so-called Einstein deflection of a light ray passing near a compact mass at a distance ξ is

$$\underline{\alpha}(\xi) = \frac{4GM}{c^2 \xi} = \frac{2 R_{sc}}{\xi} < 1, \quad (4.1)$$

where G and c stand for the constant of gravitation and the velocity of light, respectively, and where R_{sc} represents the Schwarzschild radius associated with the mass M (see the above figure). For an extended mass, it is easy to calculate the deflection angle by just summing up (integrating) the individual deflections due to all the mass elements constituting the lens.

Since there is usually just one mass concentration which acts as a lens, and which has a small size relative to the distances involved, the *thin lens approximation* is usually justified. We therefore introduce a lens plane ($\zeta = (\xi, \eta)$) through the center of mass of the lens and perpendicular to the line deflector-observer (see Fig.). All the mass can then be considered to be located in the lens plane and the deflection to take place where the ray crosses the lens plane. The deflection can therefore be expressed as a two-dimensional angle vector,

$$\underline{\alpha}(\zeta) = -\frac{4G}{c^2} \iint \frac{\Sigma(\zeta') (\zeta - \zeta')}{|\zeta - \zeta'|^2} d\xi' d\eta', \quad (4.2)$$

2. Gravitational lenses

4. PHYSICAL BASIS OF GRAVITATIONAL LENSES:

4.1. General remarks:

$$\underline{\alpha}(\xi) = \frac{4GM}{c^2 \xi} = \frac{2 R_{sc}}{\xi} \ll 1, \quad (4.1)$$

$$\underline{\alpha}(\xi) = -\frac{4G}{c^2} \iint \frac{\Sigma(\xi')(\xi - \xi')}{|\xi - \xi'|^2} d\xi' d\eta'. \quad (4.2)$$

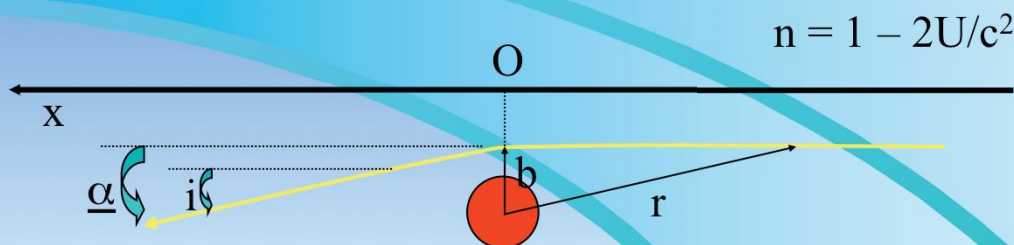

Fig.: Gravitational light deflection by a massive object

2. Gravitational Lenses:

4. PHYSICAL BASIS OF GRAVITATIONAL LENSES; 4.1. General remarks:

where $\Sigma(\xi')$ represents the surface mass density of the lens at the location ξ' (assuming that $\Sigma(\xi') = M \delta(\xi')$, where $\delta(\xi')$ is the Dirac function, the deflection law (4.1) is easily retrieved).

In Newtonian terms, the Einstein deflection also follows if one assumes a refractive index n which depends on the Newtonian gravitational potential U of the lens via the relation

$n = 1 - 2U/c^2$. We see here once more some analogy with atmospheric lensing.

For those students who already have taken a course in General Relativity, the above results may be determined as follows.

From the general expression of the space-time metrics

$$ds^2 = -(1+2U/c^2)c^2 dt^2 + (1-2U/c^2)(dx^2 + dy^2 + dz^2),$$

applied to the case of a photon ($ds^2=0$) travelling along the x space axis, we find to the first order approximation that

$$(dx/dt) = v \sim (1+2U/c^2) c \text{ and therefore } n = c/v \sim 1-2U/c^2.$$

As for the case of atmospheric lensing (Descarte's law: $n \cos(i) = Cte$), the expression of the deflection angle takes the form (since $di/dx = 1/n \, dn/db$ where b corresponds to the impact parameter -see the above figure- and using the relation $\text{tg}(i) = db/dx$)

$$\alpha = -\int (di/dx) dx = -\int 1/n \, \nabla_b n \, dx = (2/c^2) \int \nabla_b U \, dx.$$

For the case of the Newtonian potential corresponding to a point-mass lens, we find that

$$U = -GM/r = -GM/(b^2+x^2)^{1/2} \text{ and } \nabla_b U = GM \, \mathbf{b} / (b^2+x^2)^{3/2} \text{ and finally,}$$

2. Gravitational lenses

4. PHYSICAL BASIS OF GRAVITATIONAL LENSES:

4.2. The lens equation:

$$\theta - \theta_s = \alpha(\theta) = -(D_{ds} / D_{os}) \underline{\alpha}(\theta). \quad (4.3)$$

or, equivalently,

$$\zeta - \zeta_s = D_{od} \alpha(\theta) = -(D_{od} D_{ds} / D_{os}) \underline{\alpha}(\theta).$$

2. Gravitational Lenses:

4. PHYSICAL BASIS OF GRAVITATIONAL LENSES; 4.1. General remarks:

Since the Einstein deflection is independent of wavelength, gravitational lenses are *achromatic* (indirect chromatic effects may however be induced by micro-lensing, see section 9.4.).

Furthermore, *geometrical optics* can be used since physical optical effects are negligible in realistic situations.

4.2. The lens equation:

Let now the true position of the source S on the sky be defined by the angle θ_s and the image position(s) by θ_i ($i=1, 2, \dots$). These correspond of course to the solutions of the *lens equation* (cf. the previous diagram),

$$\theta - \theta_s = \alpha(\theta) = -(D_{ds} / D_{os}) \underline{\alpha}(\theta), \quad (4.3)$$

where D_{ds} and D_{os} represent respectively the "deflector- source" and "observer-source" angular size distances and where α is the displacement angle, $\alpha = -(D_{ds} / D_{os}) \underline{\alpha}$ (by application of the 'sine' rule in the previous diagram from which $\sin(\alpha)/D_{ds} = \sin(\underline{\alpha})/D_{os}$ and assuming that $\sin(\underline{\alpha}) \sim \underline{\alpha}$ and $\sin(\alpha) \sim \alpha$, $\underline{\alpha}$ and α being infinitesimal angles). We note that a given image position always corresponds to a specific source position whereas a given source position may sometimes correspond to several distinct image positions. Such cases of multiply imaged sources constitute of course the most spectacular and interesting aspects of gravitational lensing.

2. Gravitational lenses

4. PHYSICAL BASIS OF GRAVITATIONAL LENSES:

4.3. Magnification and amplification:

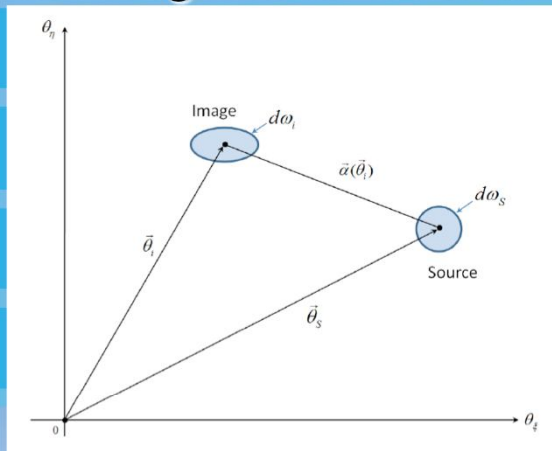

(a)

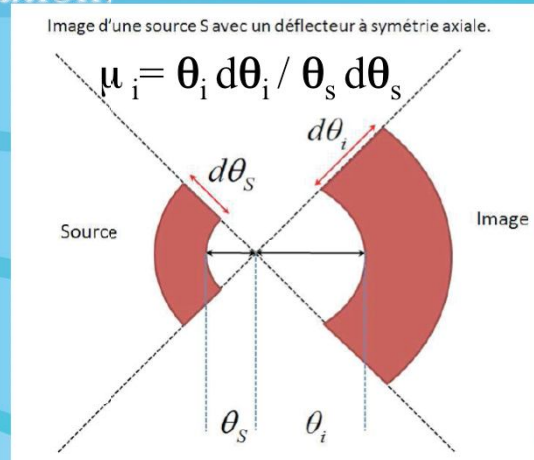

(b)

(a) Image of a lensed source as seen projected on the sky. (b) Idem, axially symmetric deflector at center!

$$\mu_i = \frac{d\omega_i}{d\omega_s} = \left| \det \left(\frac{\partial \theta_s}{\partial \theta_i} \right) \right|^{-1}$$

(4.4)

18/9/2009

25

2. Gravitational Lenses:

4. PHYSICAL BASIS OF GRAVITATIONAL LENSES; 4.2. The lens equation:

A typical lens situation is shown on the next figure, where source and image positions (one image in this case) are seen projected on the plane of the sky. We see again that the image position is shifted by α relative to the source position; note however that α is usually not constant over the source and this results in possible (de-)magnification and deformation of extended sources.

4.3. Magnification and amplification:

Since gravitational lensing preserves the surface brightness of a source, the ratio (magnification) between the solid angle $d\omega_i$ covered by the lensed image and that of the unlensed source $d\omega_s$ immediately gives the flux amplification μ_i due to lensing. More formally, this is given for an infinitesimal source by the inverse jacobian of the transformation matrix between the source and the image(s):

$$\mu_i = \frac{d\omega_i}{d\omega_s} = \left| \det \left(\frac{\partial \theta_s}{\partial \theta_i} \right) \right|^{-1} \quad (4.4)$$

If there are several images of a given source, the total magnification (amplification) is of course given by the sum of all individual image magnifications (amplifications). We shall hereafter use the term 'magnification' whenever the lensed images (cf. luminous arcs, radio rings, etc.) are resolved by the observer, thus emphasizing the change in angular size, and the term 'amplification' otherwise (cf. when referring to micro-lensing effects or to the integrated flux of unresolved macro-lensed images).

2. Gravitational lenses

4. PHYSICAL BASIS OF GRAVITATIONAL LENSES:

4.4. Axially symmetric lenses:

$$\underline{\alpha}(\xi) = \frac{4G}{c^2} \frac{M(\xi)}{\xi}, \quad (4.5)$$

$$\mu_i = \frac{\theta_i d\theta_i}{\theta_s d\theta_s}. \quad (4.6)$$

2. Gravitational Lenses:

4. PHYSICAL BASIS OF GRAVITATIONAL LENSES; 4.4. Axially symmetric lenses:

Considering a thin gravitational lens that is axially symmetric with respect to the line-of-sight, we can, in virtue of Gauss's law applied to the two-dimensional case, rewrite the deflection given in Eq.(4.2) as the scalar angle

$$\underline{\alpha}(\xi) = \frac{4G}{c^2} \frac{M(\xi)}{\xi} \quad (4.5)$$

It is as if only the mass $M(\xi)$ located inside the cylinder defined by the impact parameter ξ was contributing to the light deflection and may be thought of as acting like a single point mass located at the center (compare with Eq.(4.1)). The deflection caused by the matter distributed outside this cylinder exactly cancels out. All this reminds us of course of the situation for the case of gravitational (or Coulomb) forces caused by spherically symmetric mass (or electric charge) distributions. Since light deflection by an axially symmetric lens reduces to a one-dimensional problem (because light rays are deflected in a plane), it is also straightforward to simplify expression (4.4) for the magnification μ_i of the lensed images as follows (see the upper image at right on the previous page)

$$\mu_i = \frac{\theta_i d\theta_i}{\theta_s d\theta_s}. \quad (4.6)$$