

International Energy Agency

Resilient Cooling of Buildings Field Studies Report (Annex 80)

Energy in Buildings and Communities
Technology Collaboration Programme

May 2024



International Energy Agency

Resilient Cooling of Buildings Field Studies Report (Annex 80)

Energy in Buildings and Communities
Technology Collaboration Programme

May 2024

Authors

Dahai Qi, Université de Sherbrooke, Canada (dahai.qi@usherbrooke.ca)
Gerhard Hofer, e7 energy innovation & engineering, Austria (gerhard.hofer@e-sieben.at)
Pierre Jaboyedoff, BEEP PMTU Switzerland, Switzerland (pierre.jaboyedoff@effinart.ch)
Lili Ji, Concordia University, Canada (lili.ji2@nrc-cnrc.gc.ca)
Chang Shu, Concordia University, Canada (Chang.Shu2@nrc-cnrc.gc.ca)
Hua Ge, Concordia University, Canada (hua.ge@concordia.ca)
Liangzhu (Leon) Wang, Concordia University, Canada (leon.wang@concordia.ca)
Sama Schoisengeier, e7 energy innovation & engineering, Austria (sama.schoisengeier@e-sieben.at)
Paul Lampersberger, e7 energy innovation & engineering, Austria (paul.lampersberger@e-sieben.at)
Alina Stipsits, e7 energy innovation & engineering, Austria (alina.stipsits@e-sieben.at)
Michele Zinzi, ENEA, Italy (michele.zinzi@enea.it)
Guoqiang Zhang, Hunan University, China (gqzhang@hnu.edu.cn)
Yan Hu, Hunan University, China (yanhu5024@hnu.edu.cn)
Zhengtao Ai, Hunan University, China (zhengtaoai@hnu.edu.cn)
Abantika Sengupta, KU Leuven, Belgium (abantika.sengupta@kuleuven.be)
Hilde Breesch, KU Leuven, Belgium (hilde.breesch@kuleuven.be)
Giacomo Chiesa, Politecnico Torino, Italy (giacomo.chiesa@polito.it)
Simon Binnemans, Thomas More University, Belgium (info.kce.kempen@thomasmore.be)
Xin Zhang, Université de Sherbrooke, Canada (xin.zhang@niit.ac.jp)
Fuad Baba, Université de Sherbrooke, Canada (fuad.baba@usherbrooke.ca)

Jan Akander, University of Gävle, Sweden (Jan.Akander@hig.se)
Hossein Bakhtiari, University of Gävle, Sweden (Hossein.Bakhtiari@hig.se)
Abolfazl Hayati, University of Gävle, Sweden (Abolfazl.Hayati@hig.se)
Deepak Amaripadath, University of Liège, Belgium (deepak.amaripadath@asu.edu)
Shady Attia, University of Liège, Belgium (shady.attia@uliege.be)

© Copyright Institute of Building Research & Innovation 2024

All property rights, including copyright, are vested in Institute of Building Research & Innovation, Operating Agent for EBC Annex 80, on behalf of the Contracting Parties of the International Energy Agency (IEA) Implementing Agreement for a Programme of Research and Development on Energy in Buildings and Communities (EBC). In particular, no part of this publication may be reproduced, stored in a retrieval system or transmitted in any form or by any means, electronic, mechanical, photocopying, recording or otherwise, without the prior written permission of Institute of Building Research & Innovation.

Published by Institute of Building Research & Innovation ZT GmbH, Wipplingerstraße 23/3, 1010 Vienna Austria.

Disclaimer Notice: This publication has been compiled with reasonable skill and care. However, Institute of Building Research & Innovation, nor the Contracting Parties of the International Energy Agency's Implementing Agreement for a Programme of Research and Development on Energy in Buildings and Communities, nor their agents, make any representation as to the adequacy or accuracy of the information contained herein, or as to its suitability for any particular application, and accept no responsibility or liability arising out of the use of this publication. The information contained herein does not supersede the requirements given in any national codes, regulations or standards, and should not be regarded as a substitute for the need to obtain specific professional advice for any particular application. EBC is a Technology Collaboration Programme (TCP) of the IEA. Views, findings and publications of the EBC TCP do not necessarily represent the views or policies of the IEA Secretariat or of all its individual member countries.

DOI: 10.52776/JIIT7246

Participating countries in the EBC TCP: Australia, Austria, Belgium, Brazil, Canada, P.R. China, Czech Republic, Denmark, Finland, France, Germany, Ireland, Italy, Japan, Republic of Korea, the Netherlands, New Zealand, Norway, Portugal, Singapore, Spain, Sweden, Switzerland, Turkey, United Kingdom and the United States of America.

Additional copies of this report may be obtained from: EBC Executive Committee Support Services Unit (ESSU), C/o AECOM Ltd, The Colmore Building, Colmore Circus Queensway, Birmingham B4 6AT, United Kingdom
www.iea-ebc.org
essu@iea-ebc.org

Preface

The International Energy Agency

The International Energy Agency (IEA) was established in 1974 within the framework of the Organisation for Economic Co-operation and Development (OECD) to implement an international energy programme. A basic aim of the IEA is to foster international co-operation among the 30 IEA participating countries and to increase energy security through energy research, development and demonstration in the fields of technologies for energy efficiency and renewable energy sources.

The IEA Energy in Buildings and Communities Programme

The IEA co-ordinates international energy research and development (R&D) activities through a comprehensive portfolio of Technology Collaboration Programmes (TCPs). The mission of the IEA Energy in Buildings and Communities (IEA EBC) TCP is to support the acceleration of the transformation of the built environment towards more energy efficient and sustainable buildings and communities, by the development and dissemination of knowledge, technologies and processes and other solutions through international collaborative research and open innovation. (Until 2013, the IEA EBC Programme was known as the IEA Energy Conservation in Buildings and Community Systems Programme, ECBCS.)

The high priority research themes in the EBC Strategic Plan 2019-2024 are based on research drivers, national programmes within the EBC participating countries, the Future Buildings Forum (FBF) Think Tank Workshop held in Singapore in October 2017 and a Strategy Planning Workshop held at the EBC Executive Committee Meeting in November 2017. The research themes represent a collective input of the Executive Committee members and Operating Agents to exploit technological and other opportunities to save energy in the buildings sector, and to remove technical obstacles to market penetration of new energy technologies, systems and processes. Future EBC collaborative research and innovation work should have its focus on these themes.

At the Strategy Planning Workshop in 2017, some 40 research themes were developed. From those 40 themes, 10 themes of special high priority have been extracted, taking into consideration a score that was given to each theme at the workshop. The 10 high priority themes can be separated in two types namely 'Objectives' and 'Means'. These two groups are distinguished for a better understanding of the different themes.

Objectives - The strategic objectives of the EBC TCP are as follows:

- reinforcing the technical and economic basis for refurbishment of existing buildings, including financing, engagement of stakeholders and promotion of co-benefits;
- improvement of planning, construction and management processes to reduce the performance gap between design stage assessments and real-world operation;
- the creation of 'low tech', robust and affordable technologies;
- the further development of energy efficient cooling in hot and humid, or dry climates, avoiding mechanical cooling if possible;
- the creation of holistic solution sets for district level systems taking into account energy grids, overall performance, business models, engagement of stakeholders, and transport energy system implications.

Means - The strategic objectives of the EBC TCP will be achieved by the means listed below:

- the creation of tools for supporting design and construction through to operations and maintenance, including building energy standards and life cycle analysis (LCA);
- benefitting from 'living labs' to provide experience of and overcome barriers to adoption of energy efficiency measures;
- improving smart control of building services technical installations, including occupant and operator interfaces;
- addressing data issues in buildings, including non-intrusive and secure data collection;
- the development of building information modelling (BIM) as a game changer, from design and construction through to operations and maintenance.

The themes in both groups can be the subject for new Annexes, but what distinguishes them is that the 'objectives' themes are final goals or solutions (or part of) for an energy efficient built environment, while the 'means' themes are instruments or enablers to reach such a goal. These themes are explained in more detail in the EBC Strategic Plan 2019-2024.

The Executive Committee

Overall control of the IEA EBC Programme is maintained by an Executive Committee, which not only monitors existing projects, but also identifies new strategic areas in which collaborative efforts may be beneficial. As the Programme is based on a contract with the IEA, the projects are legally established as Annexes to the IEA EBC Implementing Agreement. At the present time, the following projects have been initiated by the IEA EBC Executive Committee, with completed projects identified by (*) and joint projects with the IEA Solar Heating and Cooling Technology Collaboration Programme by (☼):

- Annex 1: Load Energy Determination of Buildings (*)
- Annex 2: Ekistics and Advanced Community Energy Systems (*)
- Annex 3: Energy Conservation in Residential Buildings (*)
- Annex 4: Glasgow Commercial Building Monitoring (*)
- Annex 5: Air Infiltration and Ventilation Centre
- Annex 6: Energy Systems and Design of Communities (*)
- Annex 7: Local Government Energy Planning (*)
- Annex 8: Inhabitants Behaviour with Regard to Ventilation (*)
- Annex 9: Minimum Ventilation Rates (*)
- Annex 10: Building HVAC System Simulation (*)
- Annex 11: Energy Auditing (*)
- Annex 12: Windows and Fenestration (*)
- Annex 13: Energy Management in Hospitals (*)
- Annex 14: Condensation and Energy (*)
- Annex 15: Energy Efficiency in Schools (*)
- Annex 16: BEMS 1- User Interfaces and System Integration (*)
- Annex 17: BEMS 2- Evaluation and Emulation Techniques (*)
- Annex 18: Demand Controlled Ventilation Systems (*)
- Annex 19: Low Slope Roof Systems (*)
- Annex 20: Air Flow Patterns within Buildings (*)
- Annex 21: Thermal Modelling (*)
- Annex 22: Energy Efficient Communities (*)
- Annex 23: Multi Zone Air Flow Modelling (COMIS) (*)
- Annex 24: Heat, Air and Moisture Transfer in Envelopes (*)
- Annex 25: Real time HVAC Simulation (*)
- Annex 26: Energy Efficient Ventilation of Large Enclosures (*)
- Annex 27: Evaluation and Demonstration of Domestic Ventilation Systems (*)
- Annex 28: Low Energy Cooling Systems (*)
- Annex 29: ☼ Daylight in Buildings (*)
- Annex 30: Bringing Simulation to Application (*)
- Annex 31: Energy-Related Environmental Impact of Buildings (*)
- Annex 32: Integral Building Envelope Performance Assessment (*)
- Annex 33: Advanced Local Energy Planning (*)
- Annex 34: Computer-Aided Evaluation of HVAC System Performance (*)
- Annex 35: Design of Energy Efficient Hybrid Ventilation (HYBVENT) (*)
- Annex 36: Retrofitting of Educational Buildings (*)
- Annex 37: Low Exergy Systems for Heating and Cooling of Buildings (LowEx) (*)
- Annex 38: ☼ Solar Sustainable Housing (*)
- Annex 39: High Performance Insulation Systems (*)
- Annex 40: Building Commissioning to Improve Energy Performance (*)
- Annex 41: Whole Building Heat, Air and Moisture Response (MOIST-ENG) (*)
- Annex 42: The Simulation of Building-Integrated Fuel Cell and Other Cogeneration Systems (FC+COGEN-SIM) (*)
- Annex 43: ☼ Testing and Validation of Building Energy Simulation Tools (*)
- Annex 44: Integrating Environmentally Responsive Elements in Buildings (*)
- Annex 45: Energy Efficient Electric Lighting for Buildings (*)
- Annex 46: Holistic Assessment Tool-kit on Energy Efficient Retrofit Measures for Government Buildings (EnERGo) (*)
- Annex 47: Cost-Effective Commissioning for Existing and Low Energy Buildings (*)
- Annex 48: Heat Pumping and Reversible Air Conditioning (*)
- Annex 49: Low Exergy Systems for High Performance Buildings and Communities (*)
- Annex 50: Prefabricated Systems for Low Energy Renovation of Residential Buildings (*)
- Annex 51: Energy Efficient Communities (*)
- Annex 52: ☼ Towards Net Zero Energy Solar Buildings (*)

Annex 53: Total Energy Use in Buildings: Analysis and Evaluation Methods (*)
Annex 54: Integration of Micro-Generation and Related Energy Technologies in Buildings (*)
Annex 55: Reliability of Energy Efficient Building Retrofitting - Probability Assessment of Performance and Cost (RAP-RETRO)
(*)
Annex 56: Cost Effective Energy and CO2 Emissions Optimization in Building Renovation (*)
Annex 57: Evaluation of Embodied Energy and CO2 Equivalent Emissions for Building Construction (*)
Annex 58: Reliable Building Energy Performance Characterisation Based on Full Scale Dynamic Measurements (*)
Annex 59: High Temperature Cooling and Low Temperature Heating in Buildings (*)
Annex 60: New Generation Computational Tools for Building and Community Energy Systems (*)
Annex 61: Business and Technical Concepts for Deep Energy Retrofit of Public Buildings (*)
Annex 62: Ventilative Cooling (*)
Annex 63: Implementation of Energy Strategies in Communities (*)
Annex 64: LowEx Communities - Optimised Performance of Energy Supply Systems with Exergy Principles (*)
Annex 65: Long-Term Performance of Super-Insulating Materials in Building Components and Systems (*)
Annex 66: Definition and Simulation of Occupant Behavior in Buildings (*)
Annex 67: Energy Flexible Buildings (*)
Annex 68: Indoor Air Quality Design and Control in Low Energy Residential Buildings (*)
Annex 69: Strategy and Practice of Adaptive Thermal Comfort in Low Energy Buildings
Annex 70: Energy Epidemiology: Analysis of Real Building Energy Use at Scale
Annex 71: Building Energy Performance Assessment Based on In-situ Measurements
Annex 72: Assessing Life Cycle Related Environmental Impacts Caused by Buildings
Annex 73: Towards Net Zero Energy Resilient Public Communities
Annex 74: Competition and Living Lab Platform
Annex 75: Cost-effective Building Renovation at District Level Combining Energy Efficiency and Renewables
Annex 76: ☼ Deep Renovation of Historic Buildings Towards Lowest Possible Energy Demand and CO₂ Emissions
Annex 77: ☼ Integrated Solutions for Daylight and Electric Lighting
Annex 78: Supplementing Ventilation with Gas-phase Air Cleaning, Implementation and Energy Implications
Annex 79: Occupant-Centric Building Design and Operation
Annex 80: Resilient Cooling
Annex 81: Data-Driven Smart Buildings
Annex 82: Energy Flexible Buildings Towards Resilient Low Carbon Energy Systems
Annex 83: Positive Energy Districts
Annex 84: Demand Management of Buildings in Thermal Networks
Annex 85: Indirect Evaporative Cooling
Annex 86: Energy Efficient Indoor Air Quality Management in Residential Buildings
Annex 87: Energy and Indoor Environmental Quality Performance of Personalised Environmental Control Systems
Annex 88: Evaluation and Demonstration of Actual Energy Efficiency of Heat Pump Systems in Buildings
Annex 89: Ways to Implement Net-zero Whole Life Carbon Buildings
Annex 90: EBC Annex 90 / SHC Task 70 Low Carbon, High Comfort Integrated Lighting
Annex 91: Open BIM for Energy Efficient Buildings
Annex 92: Smart Materials for Energy-Efficient Heating, Cooling and IAQ Control in Residential Buildings

Working Group - Energy Efficiency in Educational Buildings (*)
Working Group - Indicators of Energy Efficiency in Cold Climate Buildings (*)
Working Group - Annex 36 Extension: The Energy Concept Adviser (*)
Working Group - HVAC Energy Calculation Methodologies for Non-residential Buildings (*)
Working Group - Cities and Communities
Working Group - Building Energy Codes

Foreword

The world is facing a rapid increase of cooling of buildings. This is driven by multiple factors, such as urbanization and densification, climate change, power shortage, and elevated comfort expectations as well as economic growth, especially in hot and densely populated regions of the world. The trend towards cooling seems inexorable. It is mandatory to guide this development towards sustainable solutions.

Against this background, it is the motivation of EBC Annex 80 “Resilient Cooling of Buildings” to develop, assess and communicate solutions of resilient cooling and overheating protection. Resilient Cooling is used to denote low energy and low carbon cooling solutions that strengthen the ability of individuals and our communities to withstand, and prevent, adverse thermal and other impacts due to changes in global and local climates.

The Annex 80’s main objective is to support a rapid transition to an environment where resilient low energy and low carbon cooling systems are the mainstream and preferred solutions for cooling and overheating issues in buildings. This can be done by the development of resiliency indicators, categorization of cooling technologies (both passive and active) and reviewing of potential and market availability and future prospects of various technologies?

This report is a main deliverable of Annex 80 and summarizes the outcomes of case studies carried out during the working phase of Annex 80. It provides an overview of implemented cooling solutions and their performance related to resiliency against heat waves and power outages. The examples illustrate exemplary applications and shall foster transfer of knowledge from research to practice but does not provide cases for all technologies assessed during Annex 80. Results from individual buildings cannot be generalized. However, these field studies demonstrate that a focus on innovative design solutions, considering climate change, can contribute to improved thermal comfort, reduced energy consumption, and lower greenhouse gas emissions. In conclusion, they showcase showing good practice in cooling technologies for each field study.

Other outcomes of EBC Annex 80 Resilient Cooling of Buildings are: the Resilient Cooling Guidebook, the Technology Profile Sheets, the Policy Recommendation Report and Sheets, and articles produced by the contributors of field studies. These are available at: <https://annex80.iea-ebc.org/>

Executive Summary

This IEA Annex 80 Subtask C report and the associated brochures provide examples of well-documented field studies. These field studies apply resilient cooling technologies to reduce energy demand and carbon emissions for cooling and reduce the overheating risk in different types of buildings, including newly constructed and existing buildings. Examples and details on building information, energy systems, resilient cooling technologies, key performance indicators (KPIs), and performance evaluation and lessons learned are included in the report and the brochures.

The present report summarizes 13 field study buildings collected in Subtask C of IEA-EBC Annex 80. This summary presents information on the field studies, the resilient cooling technologies applied in the field studies, the KPIs, and the performance evaluation and lessons learned. The values of KPIs for building similar functions, i.e., residential buildings, under different climate conditions are discussed. In the field study brochures, detailed information is included for each building.

The field studies are presented in brochure format. Each brochure contains information in a standardized format. This includes the introduction & climate, building information, resilient cooling, KPI evaluation, design simulation, performance description and evaluation, discussion, lessons learned, references & key contacts. It should be noted that it is difficult to draw very general conclusions based on the 13 field studies, given that each field study has its individual prerequisites and characteristics. However, these studies demonstrate the viability and potential of various technologies being practiced today and evaluated in anticipation of tomorrow's challenges.

Table of content

Preface	6
Foreword	9
Executive Summary	10
Abbreviations	13
1. Introduction	14
2. Field Studies Examples	15
3. Resilient Cooling Technologies	17
3.1. Reducing Heat Gains to the Indoor Environment and People Environments	17
3.2. Removing Sensible Heat from the Indoor Environment.....	18
3.3. Increasing Personal Comfort apart from Space Cooling.....	19
3.4. Removing Latent Heat from Indoor Environment.....	19
4. Key Performance Indicators (KPIs)	20
4.1. Thermal Comfort KPIs.....	20
4.1.1. Hours of Exceedance (HE).....	20
4.1.2. Indoor Overheating Degree (IOD)	20
4.1.3. Ambient Warmness Degree (AWD)	20
4.1.4. Overheating Escalation Factor (OEF)	20
4.2. Heat Stress.....	21
4.2.1. Standard Effective Temperature (SET)	21
4.2.2. Passive Survivability.....	21
4.3. Energy	21
4.4. HVAC and Grid.....	21
5. Performance Evaluation and Lessons Learned	22
5.1. KPIs for Different Cooling Technologies	22
5.2. Lessons Learned.....	25
5.2.1. Ventilative Cooling and Comfort Ventilation	25
5.2.2. Advanced Solar Shading	26
5.2.3. Thermal Mass Utilization	26
5.2.4. Advanced Glazing Technologies	27
5.2.5. Geothermal and Natural Heat Sink	27
6. Conclusion	28

References	29
Participants	30
Contributors of Field Studies	30
Full List of Participants of Annex 80	31
Structure of Field Studies Examples	34
Field Study Brochures	35

Abbreviations

Abbreviations	Meaning
AHU	Air Handling Unit
AWD	Ambient Warmness Degree
BIM	Building Information Modeling
COP	Coefficient of Performance
EBC	Energy in Buildings and Communities
EER	Energy Efficiency Ratio
FBF	Future Buildings Forum
HE	Hours of Exceedance
HVAC	Heat Ventilation and Air Conditioning
IEA	International Energy Agency
IOD	Indoor Overheating Degree
IGU	Insulated Glass Unit
KPIs	Key Performance Indicators
LCA	Life Cycle Analysis
OECD	Organization for Economic Co-operation and Development
OEF	Overheating Escalation Factor
R&D	Research and Development
SCOP	Seasonal Coefficient of Performance

1. Introduction

The foreseen effects of climate change include longer and more frequent extreme events such as heat waves, power outages, and the absence or undersized design of cooling technologies and strategies to meet future climate conditions and mitigate the risk of power outages. Sure enough, such events have consequences on the building industry; these introduce new challenges to the building cooling system and place it under unprecedented pressure. The widespread cooling systems that depend mainly on fossil fuels today (so-called active systems which require power/fuels) will not be able to stand extreme events in the long term, which will consequently present risks to humans' well-being and continue to be a driver of extreme weather. In contrast, there are technologies that reduce or deplete need of fuel/power by so-called passive systems, which reduce building cooling demand or removes excessive heat efficiently with minimal energy use, preferably with renewable energy sources (active system).

The resilient cooling approach, a low-energy and low-carbon cooling solution, offers a path to help strengthen buildings' ability to withstand and prevent the thermal and other impacts of changes in global and local climates. The cooling of a building is resilient when the capacity of the cooling system or systems integrated into the building allows it to withstand or recover from disturbances due to disruptions, including heat waves and power outages, and to adopt the appropriate strategies after failure to mitigate degradation of building performance [1]. The perspectives are both in long term in view of future climate change in general and the future extreme short term situations (heat waves and power outage).

The resilient cooling solutions are expected to be affordable, produce low to zero carbon, not have an adversely impact on human health, and be implemented in a manner that supports local industry, innovation, and infrastructure [2].

This report presents 13 field studies of resilient cooling applications collected from 7 different countries. Each field study includes a description of the design, simulation, and operational performance of the individual project. Numerous resilient cooling solutions in different buildings and different climates are summarized and compared in this report.

The field studies are presented in brochure format. Each brochure contains information in a standardized format including tabulated data such as general information, building properties, component dimensions, design criteria, design stage simulations, control strategy and so forth. The brochures consist of three main sections: 1) A summary describing the project and its resilient cooling solution. This section also includes details about the selected control strategy and design process. 2) Performance evaluation using KPIs together with other metrics. 3) Discussion and lessons learned from the design, construction and operation phases of the project.

2. Field Studies Examples

The field studies examples showcase the opportunities and benefits of Resilient Cooling through analysis and evaluation of well-documented applications of low energy and low carbon (resilient) cooling technologies. The field studies examples examine the performance gap of existing cooling applications as well as their real performance in situ, with special concern at socio-technological interaction as well as control strategies. The 13 field studies presented in this report are summarized in Table 1.

Table 1: Field studies examples

Building	country	Building Type	Acronym	Climate zone	Technology
Kindergarten St. Paulus	AT	Education	KSP	5A	Ventilative Cooling.
Wohnprojekt Wien	AT	Residence	WW	4A	Ventilative Cooling, Thermal Mass Utilization, and Natural Heat Sinks.
Sporthalle Lieferung	AT	Sports Facilities	SL	5A	Advanced Solar Shading, Ventilative Cooling, Thermal Mass Utilization, and Natural Heat Sinks.
Mol	BE	Residence	MO	4A	Advanced Solar Shading, Natural Heat Sinks, and Geothermal.
Clinic Saint-Pierre*	BE	Office	CSP	4A	Thermal Mass Utilization, and Comfort Ventilation.
KU Leuven	BE	Education	KUL	4A	Ventilative Cooling, Evaporative Cooling, and Advanced Solar Shading
Sainte Antoine School*	CA	Education	SAS	6A	Advanced Solar Shading, Ventilative Cooling, and Thermal Mass Utilization
Grands-Étres School*	CA	Education	GES	6A	Advanced Solar Shading, Thermal Mass Utilization, Ventilative Cooling, and Comfort Ventilation.
LTC Montréal*	CA	Residence	LTCM	6A	Advanced Solar Shading, Advanced Glazing Technologies, and Comfort Ventilation.
Holon Building	CN	Residence	HB	3A	Advanced Solar Shading, Advanced Glazing Technologies, and Comfort Ventilation.
Smart Ghar*, **	IN	Residence	SG	0B	Ventilative Cooling, Comfort Ventilation and Elevated Air Movement
Living Lab	IT	Office	LLE	3A	Advanced Solar Shading, Advanced Glazing Technologies, Ventilative Cooling, Compression, and Refrigeration Machines
Gävle*	SE	Office	GA	6A	Ventilative Cooling

*Field studies with simulations

** The field study of the building Smart Ghar, located in India, was contributed by the participant Mr. Pierre Ja-boyedoff from BEEP PMTU Switzerland.

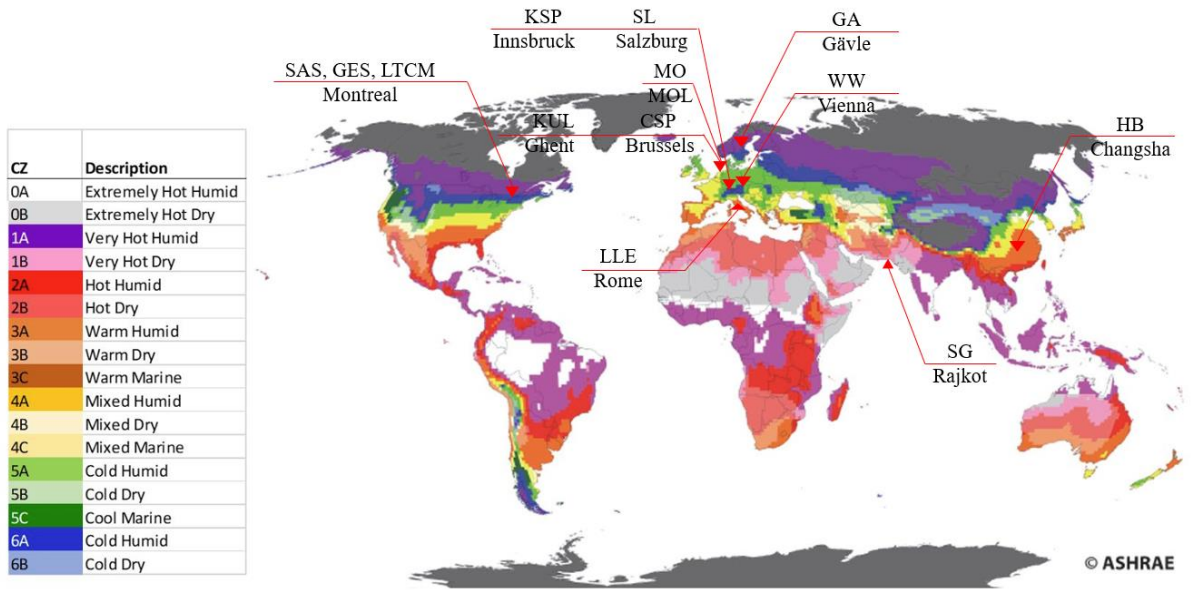

Figure 1: Climate zones of field studies buildings (Modified based on the figure from the source: ASHRAE 169 - Climate Data for Building Design Standards [3])

3. Resilient Cooling Technologies

This chapter gives a short overview of possible resilient cooling technologies applied and evaluated in field studies. Annex 80 concerns the following categorized cooling strategies:

- a. Reducing heat gains to the indoor environment and people environment
- b. Removing sensible heat from the indoor environment
- c. Increasing personal comfort apart from space cooling
- d. Removing latent heat from indoor environment

Table 2 displays which parts of the categories are addressed in terms of technological approaches. Each table title is described in more detail in the following sections.

Table 2: Resilient cooling technologies applied in field studies, allocated according to the four categories specified by the Annex.

Reducing heat gains to the indoor environment and people environment	Removing sensible heat from the indoor environment	Increasing personal comfort apart from space cooling	Removing latent heat from indoor environment
Advanced Solar Shading	Ventilative Cooling	Comfort Ventilation and Elevated Air Movement	NA
Advanced Glazing Technologies	Thermal Mass Utilization		
	Evaporative Cooling		
Green Roofs, Green Façades	Compression Refrigeration machines		
	Natural Heat Sinks		

3.1. Reducing Heat Gains to the Indoor Environment and People Environments

Advanced Solar Shading

A wide range of properties are used to characterize the energetic performance of windows but the most important shading parameters that affect cooling load are the quantity of solar heat gain (also known as SHGC or g-value) admitted to the building. Solar heat gain can be controlled by the various shading technologies available in the market, including but not limited to between-glass shading solutions, shading in sealed IGU, and solar shading integrating renewable energy technologies [4, 5].

Advanced Glazing Technologies

Traditionally, windows have been constructed using transparent glass, which facilitates excellent light transmission. However, this conventional approach also leads to substantial heat transfer, resulting in a significant impact on a building's energy consumption. Advanced glazing technologies offer a solution by harnessing the benefits of natural light while mitigating issues such as excessive heat gain, glare, and fading. One crucial parameter in glazing performance is the transmittance of daylight,

measured on a scale from 0 to 1. Various advanced glazing technologies have emerged, including smart passive glazing and smart active glazing.

Green Roofs, Green Façades

Green roof or green façade is a passive cooling technology. This cooling method relies on the evapotranspiration from plants and substrate, and its effectiveness depends on factors such as water retention capacity, water supply, plant species, and vegetated envelope typologies. By harnessing the benefits of evapotranspiration, adding mass and thermal resistance value, this cooling technology can reduce cooling loads and lower energy consumption for cooling, and mitigate the heat island effect.

3.2. Removing Sensible Heat from the Indoor Environment

Ventilative Cooling

Ventilative cooling is defined as the application of the cooling capacity of outdoor air to reduce or eliminate the cooling energy demands of buildings while guaranteeing a comfortable indoor thermal environment [6]

The most common techniques in ventilative cooling are based on the optimization of the potential of daytime and night-time ventilation [7]. Daytime comfort ventilation (or direct cooling) introduces outdoor airflow through the building during the day in order to directly remove heat gains. The process aims to improve the thermal comfort. While night cooling introduces outdoor airflow through the building during the night. The latter technique utilizes the building's thermal mass, such that the thermal mass works as a heat sink during the occupied period [5]. Ventilative cooling, such as natural night ventilation, depends on the diurnal variation of outdoor temperature. This dependence could be affected by future weather scenarios in which the nights are warmer.

Thermal Mass Utilization

Thermal mass is the material's ability to absorb and store heat energy before releasing it. While thermal mass utilization is a technique that stores heat energy in a building, it is later released to resist to large temperature fluctuations.

Pomianowski et al. [8] divide thermal mass utilization applications into passive and active systems. Passive activation means that the thermal mass is heated up or cooled down only by indoor temperature fluctuations. It does not rely on any mechanical facilities or additional energy. Active approaches include as part of the construction elements embedded water-carrying pipes and air heat exchangers to remove absorbed heat from thermal mass.

It should be noted that whilst a heavier thermal mass withstands heat waves with lower indoor temperature increase, it will prolong the building's recovery period during extended heat waves.

Evaporative Cooling

Evaporative cooling uses the evaporated water to cool the air, which is commonly applied in various cooling systems, such as evaporative air coolers and cooling towers. Evaporative cooling is effective in hot and dry climates where the process of water evaporation can absorb more moisture than the heat from the processed air, while it is less effective in areas with high humidity. The advantage of evaporative cooling is that it consumes less energy than traditional air conditioning systems.

Compression Refrigeration Machines

Compression refrigeration machines are equipment utilized in air conditioning systems to remove heat rather than generate cold. In essence, a compression refrigeration machine operates by extracting heat from water. Its primary function is to lower the temperature of water that enters the unit, which typically becomes heated by industrial equipment or an air conditioner. By employing a pump, the

machine circulates the water to the indoor unit or industrial production area, where it achieves the desired lower temperature before being returned to the active cycle.

Natural Heat Sinks

Natural heat sinks, such as groundwater, soil, and borehole heat exchangers, are commonly used resilient cooling techniques. Heat sinks are passive heat exchangers that transfer heat to a cooling medium (water or soil). This resilient cooling solution requires very little energy (other than pump power) to drive the system and is suitable for power outage events.

3.3. Increasing Personal Comfort apart from Space Cooling

Comfort Ventilation and Elevated Air Movement

Comfort ventilation refers to the controlled circulation of air in indoor spaces in order to maintain a comfortable indoor environment and simultaneously improve air quality for occupants. Comfort ventilation often works with air conditioning and heating to achieve comfortable indoor environment.

Elevated air movement refers to increasing the air velocity within an indoor space to enhance cooling effect on occupants; therefore, saving energy for cooling air.

3.4. Removing Latent Heat from Indoor Environment

Removing latent heat, achieved through the dehumidification process, occurs when the water vapor or the humidity is extracted from the air while maintaining a constant dry bulb temperature. Dehumidification is normally accompanied by the cooling or heating of the air, and its effect is used in various air conditioning applications. Depending on the method of dehumidification employed, there are two major physical principles for eliminating latent heat from indoor environments, refrigeration and desiccant dehumidification.

4. Key Performance Indicators (KPIs)

Overview

Key performance indicators, which are quantifiable measures of performance calculated over a specific time period for a specific objective, are used in this report to quantify the performance of each field study. Multiple KPIs have been selected and defined in this chapter in order to provide a universal process of measuring critical indicators of performance. The KPIs are calculated based on the test results obtained during the measurement periods or from simulation outcomes under present or future weather conditions.

The key performance indicators in this report are divided into four main categories: thermal comfort, heat stress, energy, and HVAC and grid KPIs. These categories include metrics that evaluate the ability of a space to provide a satisfactory thermal environment to its occupants, as well as the energy performance of the resilient cooling technologies. The thermal comfort KPIs quantify this ability by measuring the number of hours during a specific period where the room temperature limits are exceeded and in some field studies taking into account the outdoor air temperature. While the heat stress KPIs quantify this ability by measuring other factors including, but not limited to, wet bulb globe temperature, relative humidity, mean radiant temperature, partial vapor pressure and air velocity. The detailed definitions of these KPIs are presented below, which are cited from the references [1, 5, 9].

4.1. Thermal Comfort KPIs

4.1.1. Hours of Exceedance (HE)

HE is defined as the number of hours of occupation within a given period that exceeds a zonal comfort criterion. Unit: unmet hours.

4.1.2. Indoor Overheating Degree (IOD)

IOD is calculated as follows: hourly summation over the summertime period of the positive values of the difference between the operative temperature of the occupied building thermal zones and the zonal thermal comfort limit temperature, divided by the sum of the zonal occupied hours. Unit: °C.

4.1.3. Ambient Warmness Degree (AWD)

AWD is used to quantify the severity of outdoor thermal conditions, and indicates the heat stress of an outdoor environment. It is calculated as follows: hourly summation over the summertime period of the positive difference between the outdoor air temperature and a fixed base temperature. 18 °C has been selected as the base temperature in this report. Unit: °C.

4.1.4. Overheating Escalation Factor (OEF)

OEF is used to assess the resistivity of a building to climate change and associated overheating risks. It is calculated as the ratio of Indoor Overheating Degree (IOD) divided by Ambient Warmness Degree (AWD). $OEF < 1$ means that the building is able to suppress the outdoor thermal stress in the long-term and $OEF > 1$ means the building is unable to suppress outdoor thermal stress in the long term. OEF indicator reveals the potential of cooling technologies to resist the impact of climate change.

4.2. Heat Stress

4.2.1. Standard Effective Temperature (SET)

SET is the equivalent dry bulb temperature of an isothermal environment at 50% relative humidity, in which a subject, while wearing clothing standardized for activity concerned, would have the same heat stress (skin temperature) and thermoregulatory strain (skin wettedness) as in the actual test environment. Unit: °C.

4.2.2. Passive Survivability

Passive Survivability is the ability of the space to maintain safe indoor thermal conditions in the absence of active cooling, respectively air conditioning, within a chosen timestep.

4.3. Energy

- Annual cooling demand per conditioned floor area [kWh/m²·a].
- Annual heating demand per conditioned floor area [kWh/m²·a].
- Annual cooling site energy use per conditioned floor area [kWh/m²·a].
- Annual heating site energy use per conditioned floor area [kWh/m²·a].
- Annual CO₂ emission per conditioned floor area [gCO₂/m²·a] (use national carbon emission factor, please indicate the carbon emission factor).

4.4. HVAC and Grid

- Seasonal Energy Efficiency Ratio (SEER) and Seasonal Coefficient of Performance (SCOP): The coefficient of performance (COP), identical with the Energy Efficiency Ratio (EER) of a refrigerator, chiller or air conditioning system is the ratio between useful cooling output and power input, at a given state of operation. The Seasonal Coefficient of Performance (SCOP), equivalent identical with the Seasonal Energy Efficiency Ratio (SEER) is the same ratio over a full cooling period. COP and EER can be applied not only to active cooling technologies but also to automated passive ones. In this case, the power input is limited to auxiliary energy inputs, such as fans, circulation pumps, actuators, or controls. EN14825:2018 is recommended to use for the calculation of SEER and SCOP.
- Reduction in peak site power demand intensity: The annual reduction of site peak power demand, relative to the floor area, that can be achieved by a specific (resilient) cooling measure, against a conventional cooling solution without this specific (resilient) cooling measure. [W/m²].

5. Performance Evaluation and Lessons Learned

5.1. KPIs for Different Cooling Technologies

The table below lists the KPIs based on the measured and or simulated results for the 13 field studies with different cooling technologies. The field studies include 5 residential, 3 office, 4 school buildings, and 1 sports center. Ventilative cooling (7/13) and comfort ventilation (4/13), advanced solar shading (6/13), as well as thermal mass utilization (4/13) are the most often used cooling technologies. Three buildings use advanced glazing technologies to reduce external heat gain. Three buildings use natural heat sink to remove heat from indoor environment. One building uses geothermal energy.

Regarding the KPI:

- The field studies of KSP, WW, SL, MO, CSP, KUL, SAS, GES, HB, SG and GA, buildings present Hours of Exceedance (HE), which varies from 35 to 2144 hours. The SG building, located in climate zone 0B (extremely hot dry), has the highest value of HE (2144 hours).
- The field studies of KSP, WW, SL, CSP, KUL, LTCM, HB, and GA buildings present IOD, which varies from 0.004 to 0.58 °C.
- The field studies of KSP, WW, SL, CSP, KUL, HB, LTCM, SG and GA buildings present AWD, which varies from 1.8 to 28.69 °C.
- The field studies of KSP, WW, SL, CSP, KUL, HB, SG and GA buildings present OEF, which varies from 0.00 to 0.11.
- The field studies of KSP, WW, SL, KUL, and HB buildings present Standard Effective Temperature (SET), which varies from 25.2 to 29.9 °C.
- The field studies of KSP, WW, SL, and GA buildings present the annual cooling demand per conditioned floor area, which varies from 0 to 12.1 kWh/m²·a.
- The field studies of KSP, WW, SL, MO, CSP, KUL, SAS, GES, and GA buildings present the annual cooling site energy use per conditioned floor area, which varies from 0 to 15.02 kWh/m²·a.
- The field studies of KSP, WW, SL, MO, CSP, KUL, SG, and GA buildings present the annual carbon emissions per conditioned floor area, which varies from 0 to 5720 g·CO_{2e}/m²·a.
- The field studies of WW and CSP buildings present the seasonal coefficient of Performance (SCOP), which varies from 0 to 5720.
- The field study of GA building presents the reduction in peak site power demand intensity, which is 3.1 W/m² at the current climate condition (1991-2020) and 1.5 W/m² at the future climate (2050s) condition.

It should be noted that the limited number of field studies in this project makes it challenging to recommend a specific value range for each KPI, indicating the need for additional research.

It has been observed that there are five residential buildings (Buildings WW, MO, LTCM, HB and SG) in the field studies, four of which are new buildings. Four of them use ventilative cooling or comfort ventilation and elevated air movement. Regarding the thermal comfort KPIs, HE of SG building (Climate zone 0B) is 2144 (hours above 30 °C), much higher than the other buildings (Climate zone 3A, 4A).

Table 3: Resilient cooling technologies and KPIs of buildings

Buildings	KSP	WW	SL	MO	CSP	KUL	SAS	GES	LTCM	HB	SG	LLE	GA	
Country	AT	AT	AT	BE	BE	BE	CA	CA	CA	CN	IN	IT	SE	
Climate zone	5A	4A	5A	4A	4A	4A	6A	6A	6A	3A	0B	3A	6A	
Building information														
Building Type	Residence		Y		Y					Y	Y	Y		
	Offices					Y							Y	Y
	Hospitals													
	Education	Y					Y	Y	Y					
	Sports facilities			Y										
Others														
Project type	New building	Y	Y	Y	Y	Y	Y				Y	Y		
	Renovation/existing							Y	Y	Y			Y	Y
Resilient cooling technologies														
Reducing heat gains to the indoor environment and people environment	Advanced solar shading						Y	Y	Y	Y	Y		Y	
	Advanced glazing technologies									Y	Y		Y	
	Green roof, green facades									Y				
Removing sensible heat from indoor environments	Ventilative cooling	Y		Y			Y	Y		Y		Y	Y	Y
	Thermal mass utilization		Y	Y				Y	Y					
	Evaporative cooling				Y		Y							
	Compression refrigeration machines					Y							Y	
Natural heat sinks		Y	Y	Y										
Increasing personal comfort	Comfort ventilation and elevated air movement		Y						Y		Y	Y		

Continue Table 3.

Buildings		KSP	WW	SL	MO	CSP	KUL	SAS	GES	LTCM	HB	SG	LLE	GA
KPIs														
Thermal comfort	HE, unmet hours	127	1245	110	168.84	35	169	max. 110 (Rm 200)	max. 130 (Rm 118)	88 (natural ventilation)	4	2144	/	252 (southern half); 119 (northern half)
	IOD, °C	0.58	0.393	0.078	/	0.05	0.004	/	/	/	0.116	0.38	/	0.2
	AWD, °C	28.69	3.57	8.29	/	4.43	4.1	/	/	2.73	13.8	9.8	/	1.8
	OEF	0.02	0.11	0.009	/	0.01	0.00	/	/	/	0.008	0.039	/	0.11
Heat stress	SET, °C	25.3	25.2	28.3	/	/	29.9	/	/	/	28.2	/	/	/
	Passive Survivability	Yes	Yes	Yes	/	/	Yes	/	/	/	Yes	Yes	/	/
Energy	Annual cooling demand/cooling load per conditioned floor area, kWh/m ² -a	0	0.63	12.1	/	/	/	0	0	/	/	/	/	4.3 (measurement: 1 Jun. -30 Sep. 2021 & 1-31 May 2022)
	Annual cooling site energy use per conditioned floor area, kWh/m ² -a	0	1.52	13	4.32	15.02	10.4	0	0	/	0.6	/	/	0.6 (1991-2020) and 1.0 (2050s)
	Annual heating site energy use per conditioned floor area, kWh/m ² -a	88.8	52.2	24	/	/	/	/	/	/	/	/	/	/
	Annual carbon emissions per conditioned floor area, g-CO ₂ e/m ² -a	0	143	2951	855.36	4055	5720	/	/	/	/	1500	/	2.11
HVAC and grid	Seasonal Coefficient of Performance (SCOP)	/	0.4	/	/	2.5	/	/	/	/	/	/	/	/
	Reduction in peak site power demand intensity, W/m ²	/	/	/	/	/	/	/	/	/	/	/	/	3.1 (current climate 1991-2020); 1.5 (future climate 2050s))

Notes: Due to the limited available data, this chapter's KPI values span June 15, 2019 to August 8, 2019 for MO building, and from July 26, 2022 to August 2, 2022 for HB building. Since the climate zone of building SG is 0B (extremely hot), the thermal comfort KPIs of SG building are calculated using the zonal thermal comfort limit temperature 30 °C.

5.2. Lessons Learned

5.2.1. Ventilative Cooling and Comfort Ventilation

Ventilative cooling is an effective cooling approach for achieving comfort, which can be realized through natural ventilation, mechanical ventilation and hybrid ventilation. To increase potential energy savings of ventilative cooling, the following methods can be applied:

- The timer-control of ventilative cooling should be considered in order to achieve demand-based operation. For example, for WW building (a residential building), without a timer program, the ventilation system is operated all year round, which should be switched off during the non-occupied hours, such as the night, weekends, and holidays. This could save 50 % electricity.
- Besides considering the time-control of ventilative cooling, regulating the ventilation should also consider the outside and indoor temperature (KSP building), in order to achieve more energy savings.
- The fresh air system can be controlled manually by the users for adjusting air flow rate and CO₂ concentration levels. However, improper operation by the users will lead to overheating in the flats and waste energy in summer. Therefore, an integrated guiding framework for terminal user control and centralized control should be proposed (HB building).
- Even in hot climates, for example the climate zone 0B, it is possible to offer reasonably acceptable thermal comfort for people used to the climate using ventilative cooling, but needs the assistance of ceiling fans in their apartments (SG building).
- For cooling by mechanical ventilation, the energy efficiency, indicated by the specific fan power (SFP) of the fans, should be paid more attention. A higher SFP value may lead to more energy consumption for ventilative cooling, compared with mechanical cooling (e.g., cooling by heat pump). In the field study of GA building, the electrical fans in air-handling units (AHUs) are old. The SFP of these fans in simulation studies on this historic office building was considered $1.5 \text{ kW}/(\text{m}^3 \cdot \text{s}^{-1})$, based on the suggested values by older Swedish building regulations. One optimization potential is to replace the old fans with more efficient ones with lower SFP values, which contributes to lower electricity use in AHUs' fans. It is also worth mentioning that the mechanical night ventilation strategy could not contribute to reducing the total electricity use for space cooling in both the vapor compression chiller and the AHUs' fans in the ventilative cooling system with the current high SFP values in AHUs' electrical fans. Electrical fans with SFP values lower than $1.0 \text{ kW}/(\text{m}^3 \cdot \text{s}^{-1})$ are recommended for significant contribution of mechanical night ventilation strategy to reducing total electricity use for space cooling.

It should be noted that compared with mechanical cooling, ventilative cooling capacity is limited because it depends on the ventilation rate, the climate condition and air is not an efficient energy carrier due to its low heat capacity. Therefore, with an increased rate of climate change and urban heat islands, higher rates of summer discomfort can be foreseen (CSP building). For the field study of SAS building, the number of heatwaves will rise from four heatwaves during the historical period (2001-2020) to 38 heatwaves in the mid-term (2041-2060) and to 88 in the long-term (2081-2100) future years. Using the heatwave detection operational method, 2020 was the hottest in the historical period. 2044 and 2090 will be the hottest years in the mid and long-term future periods, respectively. The overheating risk in the hottest classroom under the current operational situation will increase to 333 hrs and 437 hrs in 2044 and 2090, respectively, if no mitigation measures are applied.

In the review of health and comfort, it is necessary to increase the cooling capacity of the building system with ventilative cooling to deal with the overheating, particularly in long-term care buildings (e.g. LTCM

building), which vulnerable people (older people) occupy. To satisfy the cooling demand of buildings, additional approaches are needed to reduce cooling demand and/or increase cooling capacity.

- Approach to reducing cooling demand: The use of exterior blind roll (screen shading) or a combination of night cooling and other mitigation measures that reduce solar heat gain (such as cool roof, exterior overhang, lower window SHGC) can achieve acceptable thermal conditions by decreasing overheating hours (e.g. for SAS field study, the overheating hours are decreased from 110 to 16 hours and the indoor daily weighted temperature is reduced from 12 to 6 °C·day). For the field study of GES, the use of night cooling combined with the exterior blind roll reduces the overheating hours to 10 hours in 2044, however, in 2090, additional measures such as adding a cool roof should be considered, which can reduce the overheating hours to 30 hours within the acceptable limit (40 hours). The field study of LTCM also found that replacing interior shading with exterior shading is another way to deal with the overheating problem.
- Approach to increase cooling capacity: such as Thermal Activation Building System (TABS) (SL building), water wells (WW building), renewable energy sources (proposed by CSP) and mechanical cooling. For example, the current ventilative cooling in the GA building is not effective in fully meeting the thermal comfort requirements in office rooms during the cooling season. A new ventilative cooling system with a larger capacity is required (with a new chiller or district cooling exchanger with a larger capacity and/or new AHUs with higher ventilation rates). AHUs with higher ventilation rates require larger duct systems in the building, which is a challenge for the existing building due to the limited space. An alternative approach is to replace the ventilative cooling system with local cooling units and apply ventilation only for ventilating the office room and mechanical night cooling.

5.2.2. Advanced Solar Shading

Advanced solar shading is one of the most popular resilient cooling approaches to reduce the cooling demand by reducing solar gain.

- In HB building, by controlling shading facilities, a large reduction in heat gain of the building can be achieved.
- In GES building, the use of exterior blind roll (screen shading) or a combination of night cooling and other mitigation measures that reduce solar heat gain (such as cool roof, exterior overhang, lower window SHGC) can achieve acceptable thermal conditions by reducing overheating hours from 130 to 35 hours and the indoor daily weighted temperature from 12 to lower than 6 °C·day for all days.
- In SAS building, the use of exterior blind rolls (screen shading) or a combination of night cooling and other mitigation measures that reduce solar heat gain (such as cool roof, exterior overhang, lower window SHGC) can achieve acceptable thermal conditions by reducing overheating hours from 110 to 16 hours and the indoor daily weighted temperature from 12 to 6 °C·day.
- In LTCM building, replacing interior shading with exterior shading is another way to deal with overheating problem.
- The LLE field study found that the venetian blinds could be more effective in case of conventional glazing units with high solar factor (g-value). In case of high performing glazing, additional shading might be dedicated to daylighting, rather than additional solar control.

5.2.3. Thermal Mass Utilization

Building thermal mass can be integrated with cooling systems, such as ventilative cooling, for increasing potential energy savings. The building thermal mass, such as the building concrete structure, can be used to store energy during the night when the outdoor temperature is lower than the indoor temperature and release cooling energy during the daytime of summer (WW). This will contribute to less energy consumption for cooling and reduction of peak electricity demand; therefore, reducing carbon emissions.

In SL building, the massive base plate is a crucial element of the TABS. It was installed due to flood protection and its mass is used in combination with the solar thermal system and well water cooling. The building was designed to minimize the cooling demand. Measures to achieve this are the compact and heavy construction in combination with night cooling for TABS and a controlled shading. At a low cooling demand, the heat can be stored in the storage mass during the day and be cooled via window ventilation with the cold outside air at night.

5.2.4. Advanced Glazing Technologies

Advanced glazing technologies are often used for reducing building cooling load. For example, in the field study of HB building, 3-paned insulating glass windows or 4-paned insulating glass windows were investigated. Five thermal insulation measures were used in this project: 22 cm rock wool for exterior walls, 4-paned glass windows, exterior shade, interior shade, and fresh air heat recovery. The insulation measures, together with high-efficient fresh air heat recovery system, enabled the Garden A-1 building to have only 16% of energy consumption, compared to a traditional residential building. In the field study of LLE, the solar selective glazing units reduces the solar gain significantly. The addition of venetian blinds inside the glazing gap had a limited additional impact, depending also on the orientation.

5.2.5. Geothermal and Natural Heat Sink

As mentioned above, additional cooling is often required when using ventilative cooling. In the field study of SL building, well water is used as the additional cooling approach. With well cooling, cold groundwater is used for cooling. The groundwater is drawn in via an extraction well and fed into the cooling circuit. It is then fed back into the groundwater system via the injection well. Higher cooling demand is covered via well cooling (73 kW). The cold groundwater is used for TABS and to cool the supply air of the ventilation system.

In the field of MO building, free geothermal cooling during summer is used with the other cooling methods, i.e., the heat pump and indirect evaporative cooling. In general, it proves possible to attain an acceptable summer comfort in this residential case, by using low-energy cooling, like free geothermal cooling.

6. Conclusion

The field studies show that ventilative cooling is the most widely applied resilient cooling technology as regard to night flush ventilation and comfort ventilation. It should be noted that due to its limited cooling capacity, additional technologies should be integrated with ventilative cooling to satisfy cooling demand. The additional technologies can be categorized into two groups, technologies to reduce cooling demand and technologies to increase cooling capacity. The technologies to reduce cooling demand can be advanced solar shading to reduce solar gain, advanced glazing technologies to reduce external heat gain, and the thermal mass utilization to store cooling energy (free cooling). The technologies to increase cooling capacity, in the field studies, are geothermal technologies and well cooling.

References

- [1] S. Attia, S., R. Levinson, et al., “Resilient cooling of buildings to protect against heat waves and power outages: Key concepts and definition,” *Energy and Buildings*, 239, 110869, 2021.
- [2] W. Miller, A. Machard, et al., “Conceptualising a resilience cooling system: a socio-technical approach,” 2021.
- [3] ASHRAE, “ANSI/ASHRAE Standard 169-2013, Climatic Data for Building Design,” 2013.
- [4] P. Holzer, P. Stern, et al., “Resilient Cooling of Buildings – State of the Art Review,” 2022.
- [5] C. Zhang, O.B. Kazanci, et al., “Resilient cooling strategies—A critical review and qualitative assessment,” *Energy and Buildings*, 251, 111312, 2021.
- [6] G. Chiesa, F. Fasano, P. Grasso, “Thermal Comfort and Climatic Potential of Ventilative Cooling in Italian Climates,” 2022.
- [7] P. Heiselberg, et al., “Ventilative Cooling Design Guide,” 2018.
- [8] M. Pomianowski, P. Heiselberg, Y. Zhang, “Review of thermal energy storage technologies based on PCM application in buildings.,” 2013.
- [9] C. Zhang, O.B. Kazanci, et al., “IEA EBC Annex 80 - Dynamic simulation guideline for the performance testing of resilient cooling strategies,” Department of the Built Environment, Aalborg University. DCE Technical Reports No. 299., 2021.

Participants

Contributors of Field Studies

<p>Austria e7 energy innovation & engineering Gerhard Hofer Email: gerhard.hofer@e-sieben.at</p> <p>Belgium Thomas More University Simon Binnemans Email: info.kce.kempen@thomasmore.be</p> <p>KU Leuven Hilde Breesch Email: hilde.breesch@kuleuven.be</p> <p>University of Liège Shady Attia Email: shady.attia@uliege.be</p> <p>University of Liège Deepak Amaripadath Email: Deepak.Amaripadath@uliege.be</p> <p>Canada Concordia University Liangzhu (Leon) Wang Email: leon.wang@concordia.ca</p> <p>Concordia University Hua Ge Email: hua.ge@concordia.ca</p> <p>Concordia University & National Research Council Canada Chang Shu Email: Chang.Shu2@nrc-cnrc.gc.ca</p> <p>Concordia University & National Research Council Canada Lili Ji Email: lili.ji2@nrc-cnrc.gc.ca</p> <p>Université de Sherbrooke Fuad Baba Email: fuad.baba@usherbrooke.ca</p>	<p>China Hunan University Guoqiang Zhang Email: ggzhang@hnu.edu.cn</p> <p>Hunan University Zhengtao Ai Email: zhengtaoai@hnu.edu.cn</p> <p>Hunan University Yan Hu Email: yanhu5024@hnu.edu.cn</p> <p>Italy ENEA Michele Zinzi Email: michele.zinzi@enea.it</p> <p>Politecnico Torino Giacomo Chiesa Email: giacomo.chiesa@polito.it</p> <p>Sweden University of Gävle Hossein Bakhtiari Email: Hossein.Bakhtiari@hig.se</p> <p>University of Gävle Jan Akander Email: Jan.Akander@hig.se</p> <p>University of Gävle Abolfazl Hayati Email: Abolfazl.Hayati@hig.se</p> <p>Switzerland BEEP PMTU Switzerland Pierre Jaboyedoff Email: pierre.jaboyedoff@effinart.ch</p>
---------------------------------------------------------------------------------------------------------------------------------------------------------------------------------------------------------------------------------------------------------------------------------------------------------------------------------------------------------------------------------------------------------------------------------------------------------------------------------------------------------------------------------------------------------------------------------------------------------------------------------------------------------------------------------------------------------------------------------------------------------------------------------------------------------------------------------------------------------------------------------------------------------------------------------------------------------------------------------------------------------------------------------------------------------------------------------------------------------------------------------------------------------------------------------------------------------------------------------------------------------------------------------------------------------------------------------------------------------------------------------------------------------------------------------------------------------------------------	-------------------------------------------------------------------------------------------------------------------------------------------------------------------------------------------------------------------------------------------------------------------------------------------------------------------------------------------------------------------------------------------------------------------------------------------------------------------------------------------------------------------------------------------------------------------------------------------------------------------------------------------------------------------------------------------------------------------------------------------------------------------------------------------------------------------------------------------------------------------------------------------------------------------------------------------------------------------------------------------------------------------------------------------------------------------------------------------------------------------------------------------------------------------------------------------------------

Full List of Participants of Annex 80

Country	Institution	Prenome	Surname
Australia	Queensland University of Technology	Wendy	Miller
	University of Wollongong	Paul	Cooper
Austria	Institute of Building Research & Innovation	Peter	Holzer
	Institute of Building Research & Innovation	Philipp	Stern
	Institute of Building Research & Innovation	Patryk	Czarnecki
	e7 Energie Markt Analyse GmbH	Gerhard	Hofer
	e7 Energie Markt Analyse GmbH	Paul	Lampersberger
	e7 Energie Markt Analyse GmbH	Sama	Schoisengeier
	Vienna University of Technology	Ardeshir	Mahdavi
	Vienna University of Technology	Helene	Teufl
Belgium	Ghent University	Marijke	Steeman
	KU Leuven	Douaa	Al-Assaad
	KU Leuven	Hilde	Breesch
	KU Leuven	Delphine	Ramon
	KU Leuven	Abantika	Sengupta
	Thomas More, Kenniscentrum Energie	Margot	De Pauw
	University of Liège	Deepak	Amaripadath
	University of Liège	Shady	Attia
	University of Liège	Essam	Elnagar
	University of Liège	Vincent	Lemort
	University of Liège	Ramin	Rahif
Brazil	Federal University of Santa Catarina	Letícia G.	Eli
	Federal University of Santa Catarina	Amanda	Krelling
	Federal University of Santa Catarina	Roberto	Lamberts
	Federal University of Santa Catarina	Marcelo	Salles Olinger
	Ministry of Mines and Energy	Alexandra	Maciel
Canada	Concordia University, Montreal	Hua	Ge

	Concordia University, Montreal	Liangzhu	Wang
	National Research Council Canada	Abhishek	Gaur
	National Research Council Canada	Abdelaziz	Laouadi
	National Research Council Canada	Chang	Shu
	National Research Council Canada	Lili	Ji
	Université de Sherbrooke	Dahai	Qi
	Université de Sherbrooke	Fuad	Baba
	Université de Sherbrooke	Xin	Zhang
	Université de Sherbrooke	Haohan	Sha
China	Hunan University	Guoqiang	Zhang
	Hunan University	Zhengtao	Ai
	Hunan University of Science and Technology	Yin	Wei
Denmark	Aalborg University	Per	Heiselberg
	Aalborg University	Chen	Zhang
	Technical University of Denmark	Bjarne W.	Olesen
	Technical University of Denmark	Ongun B.	Kazanci
	Technical University of Denmark	Dragos-Ioan	Bogatu
France	CSTB	Anais	Machard
	La Rochelle Université	Emmanuel	Bozonnet
	La Rochelle Université	Feryal	Chtioui
Germany	Fraunhofer Institute for Building Physics IBP	Afshin	Afshari
Italy	ENEA	Ezilda	Costanzo
	ENEA	Michele	Zinzi
	Politecnico Torino	Giacomo	Chiesa
	Politecnico Torino	Vincenzo	Corrado
	Politecnico Torino	Mamak	P. Tootkaboni
Norway	Norwegian University of Science and Technology	Mohamed	Hamdy
	Norwegian University of Science and Technology	Shabnam	Homaei
Singapore	National University of Singapore	Poh S.	Lee
Sweden	Chalmers University	Taha	Arghand
	Chalmers University	Theofanis	Psomas
	University of Gävle	Jan	Akander
	University of Gävle	Hossein	Bakhtiari
	University of Gävle	Mathias	Cehlin

	University of Gävle	Sadegh	Forgani
	University of Gävle	Abolfazl	Hayati
	University of Gävle	Sana	Sayadi
Switzerland	Effin'Art	Pierre	Jaboyedoff
Turkey	Gebze Technical University	Gamze	Gediz Ilis
UK	Brunel University	Maria	Kolokotroni
	Brunel University (prev.)	Agnese	Salvati
	Oxford Brookes University	Rajat	Gupta
	School of Architecture and the Built Environment Lincoln	Behzad	Sodagar
USA	Lawrence Berkeley National Laboratory	Haley	Gilbert
	Lawrence Berkeley National Laboratory	Ronnen	Levinson
	Lawrence Berkeley National Laboratory	Sang H.	Lee
	Lawrence Berkeley National Laboratory	Christian	Kohler
	Lawrence Berkeley National Laboratory	Tianzhen	Hong
	Lawrence Berkeley National Laboratory	Charlie	Curcija
	Lawrence Berkeley National Laboratory	Xuan	Luo
	Lawrence Berkeley National Laboratory	Susan	Mazur-Stommen
	Lawrence Berkeley National Laboratory	Stephen	Selkowitz
	Lawrence Berkeley National Laboratory	Yujie	Xu
	Lawrence Berkeley National Laboratory	Nari	Yoon
	Center for the Built Environment, University of California	Hui	Zhang
	Center for the Built Environment, University of California	Ed	Arens

Structure of Field Studies Examples

The brochures of the field studies all have a common structure, that has been summarised in the table below. The following table illustrates the content of each section enabling easy search for information.

Section	Title	Section Description
1	Introduction & Climate	General introduction and building key information including building type, building size, completion year, location and climate zone.
2	Building	2.1 Additional building Information including layout and section drawings, thermophysical properties (e.g. U-values), and special construction features. 2.2 Summary overview of the mechanical (heating, cooling, and ventilation) and electrical systems, including schematic diagrams.
3	Resilient Cooling	Resilient Cooling Technology: Description of the resilient cooling technologies applied including, principles, solutions, components dimensioning, and controls strategy. Design Simulation: Description and results of the building's thermal and/or control strategies simulation.
4	KPI Evaluation	Thermal comfort KPIs and heat stress KPIs quantifying the performance of the field study.
5	Performance Evaluation	Project specific operational performance evaluations.
6	Discussion, Lessons Learned	Key outcomes of applying a certain resilient cooling technology, the feasibility and limitations of the technology, and future recommendation.
7	References & Key Contacts	Relevant literature and building contact data.

Field Study Brochures

1. Introduction & Climate

1.1 Introduction

The construction of the Kindergarten St. Paulus was completed and put into operation in 2017. It has two stories and can accommodate up to 90 children. The planning was carried out according to a low-tech concept and the building does not feature a ventilation system. Air exchange is provided by window ventilation with automatic window switching. Cooling is also provided by window ventilation, using the cool night air.



Fig.1 EXTERIOR VIEW, NORTH-EAST VIEW, KINDERGARTEN ST. PAULUS

1.2 Local Climate

Location: The building is located in the city of Innsbruck, Austria, with the coordinates 47°16'23"N 11°24'58"E.

Climate Zone: The building is located in a temperate climate zone (5A). This zone is characterized by warm to cool temperate climate.

Table.1 KEY INFORMATION ABOUT THE BUILDING

Location	Innsbruck, Austria
Building Type	Kindergarten
Retrofit (Y/N)	N
Surroundings (Urban/Rural)	Urban
Year of Completion	2017
Floor Area (m²)	999
Shape Coefficient (m)	1.74
Openable Area to Floor Area Ratio (%)	65.6%
Window to Wall Ratio (%)	56.6%
Climate Zone	Temperate (5A)
No. of Days with Te max > 25	124
Cooling Season Humidity	70%
Heating Degree days 12/20 (Kd)	3,545

Climate Zone	Description
0A	Extremely Hot Humid
0B	Extremely Hot Dry
1A	Very Hot Humid
1B	Very Hot Dry
2A	Hot Humid
2B	Hot Dry
3A	Warm Humid
3B	Warm Dry
3C	Warm Marine
4A	Mixed Humid
4B	Mixed Dry
4C	Mixed Marine
5A	Cool Humid
5B	Cool Dry
5C	Cool Marine
6A	Cold Humid
6B	Cold Dry
7	Very Cold
8	Subarctic

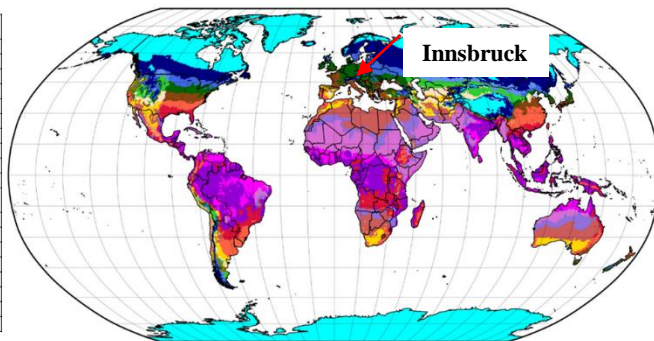

Fig.2 CLIMATE MAP (ASHRAE 169 - CLIMATE DATA FOR BUILDING DESIGN STANDARDS)

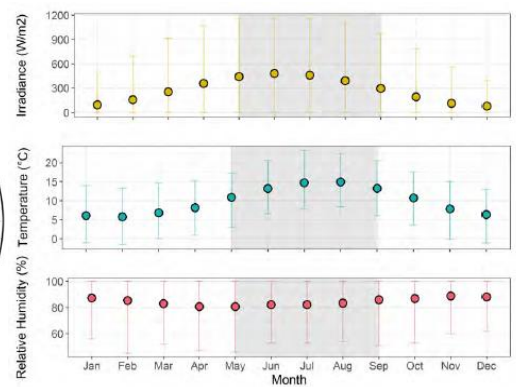

Fig.3 MEAN, MAXIMUM AND MINIMUM EXTERNAL CONDITIONS IN INNSBRUCK, USING TMY3 FROM METEONORM 7. RADIATION MEASURED ON A HORIZONTAL SURFACE

2. Building

2.1 Envelope and Construction

The building is a kindergarten and was completed in 2017.

Special features of the building envelope and construction

- 2-Story solid construction low-tech building
- Reinforced concrete skeleton with curtain-type wooden façade
- External wall construction with wooden facade: reinforced concrete, rock wool insulation board, wooden lath/air layer, façade elements
- External wall construction with external plaster: reinforced concrete, rock wool insulation board, filler, exterior plaster
- Window ventilation by automatic window control system
- 3-pane thermal insulation glazing
- Compact construction, $A/V = 0.57$ [1/m], characteristic length 1.74 [m].

Table.2 INFORMATION PLANNING, OPERATION AND USE

Information on planning, operation and use

Object use	Kindergarten
Integral planning process	The owner led the planning process
Technical management	Own operational management
Energy monitoring	A dedicated monitoring system was already in place (based on building automation) and is in use. Additional monitoring instruments have been installed to record room conditions and window control.

Table.3 BUILDING PROPERTIES

Property	Unit	Value
Hours of occupancy	h/week	52.5
Window U-value	W/(m ² K)	0.9
Window g-value	-	0.48
Average Wall U-value	W/(m ² K)	0.19
Roof U-value	W/(m ² K)	0.12
Floor U-value	W/(m ² K)	0.17
Window to Wall Ratio	%	56.6%
Air-tightness (@50 Pa)	1/h	0.5



Fig.4 EXTERIOR VIEW, NORTH-WEST VIEW, KINDERGARTEN ST. PAULUS

2. Building

2.2 Energy Systems

Schematic design of energy system

Heating is provided by underfloor heating supplied by the district heating system. Cooling is provided by window ventilation using the cold night air. Electricity is supplied by the public network. Six decentralized electric water heaters provide hot water.

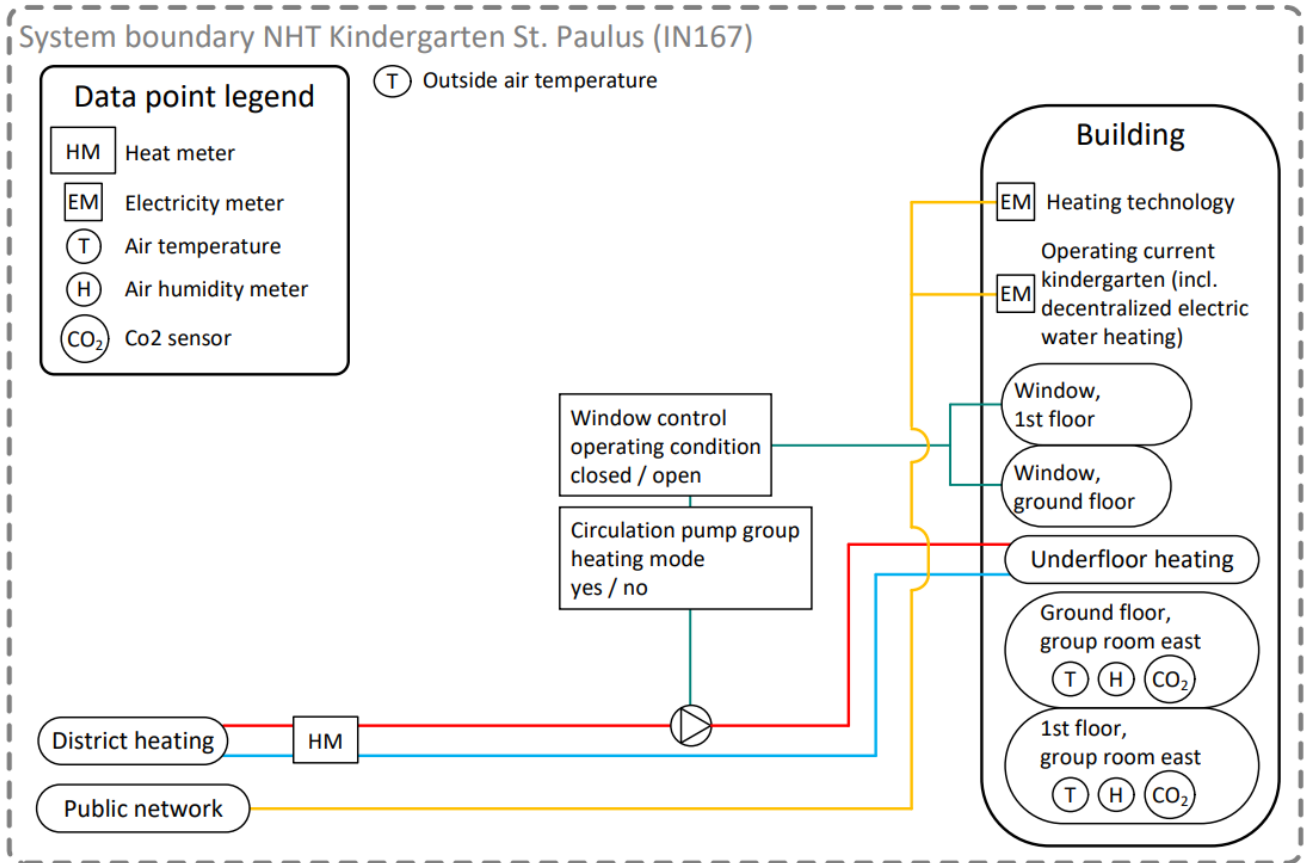

Fig.5 SCHEMATIC DIAGRAM OF THE KINDERGARTEN ST. PAULUS, BUILDING TECHNOLOGY AND MEASUREMENT CONCEPT

Description of Energy System

Heating System

The building is heated with district heating. A total of 45 kW has been connected for heating the building.

Cooling System

The building is cooled via window ventilation. 26 windows on the ground floor and 12 windows on the first floor are time-controlled. There are different operating modes for winter and summer.

Electrical Power Supply

Electricity consumption is covered by the public grid.

3. Resilient Cooling

3.1 Principles

The massive construction acts as a buffer, allowing cold night air to be used for cooling via window ventilation without the risk of overheating during the day.

3.2 Structure of resilient cooling technology

REMOVING HEAT FROM INDOOR ENVIRONMENT

Ventilation Cooling

The heat accumulated during the day is released into the environment through air exchange with the cool night air. This is achieved by automated, time-controlled window ventilation. There are 26 windows on the ground floor and 12 windows on the first floor, which are time-controlled according to the different operating modes for winter and summer. In summer, the windows are opened from 4:00 am to 7:00 am. It is possible for users to open the windows manually outside the set times.

Table.4 STRUCTURE OF THE SYSTEM

1. Reducing heat loads to people and indoor environments	
1.1.	Advanced solar shading
1.2.	Advanced cool materials
1.3.	Advanced glazing technologies
1.4.	Ventilated façades
1.5.	green roofs, green façades
2. Removing heat from indoor environments (production, emission and combined)	
2.1.	Ventilative cooling
2.2.	Thermal mass utilization
2.3.	Evaporative cooling
2.4.	Sky radiative cooling
2.5.	Compression refrigeration machines
2.6.	Adsorption chillers
2.7.	Natural heat sinks
2.8.	Radiant Cooling
3. Increasing personal comfort apart from space cooling	
3.1.	Comfort ventilation and elevated air movement
3.2.	Micro-cooling and personal comfort control
4. Removing latent heat from indoor environments	
4.1.	Dehumidification

Daily Automatic Windows Opening Hours

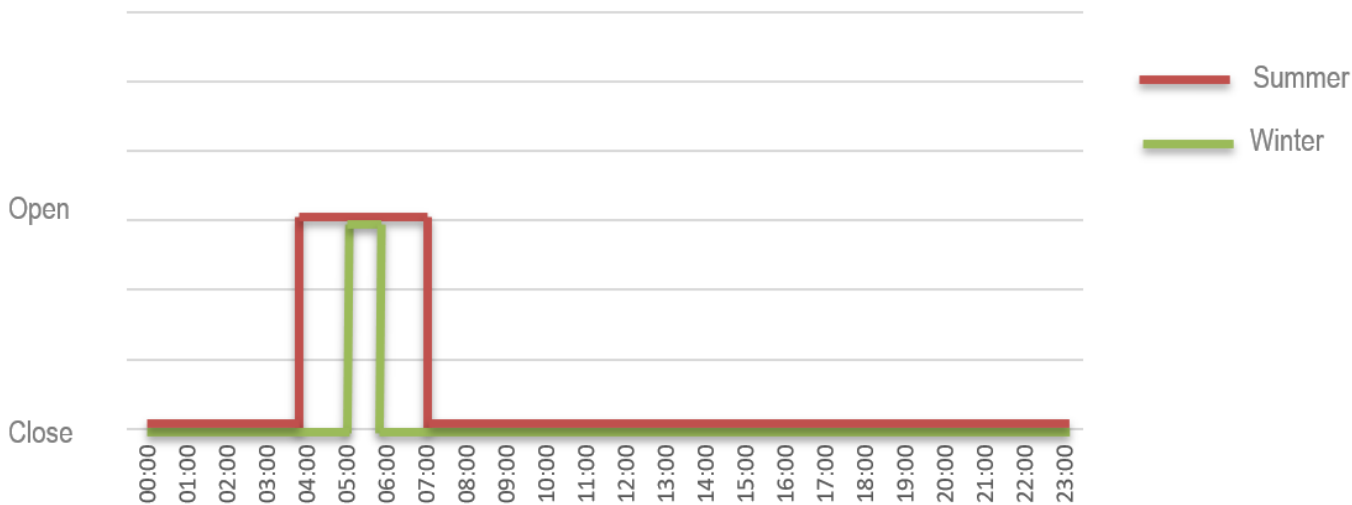

Fig.6 WINDOW OPENING SCHEDULE

3.2 Structure of resilient cooling technology

The average hourly wind speed in Innsbruck experiences mild seasonal variation over the course of the year and varies between 2.7 to 4.1 mph, see Figure 7. Wind speed between 1 and 7 mph is classified as light breeze, that is not enough to move small tree branches or raise dust and loose paper from the ground.

This makes Innsbruck a vary suitable location for ventilative cooling, as there is low risk of strong winds in the region that might blow dust, tree leaves or other objects into the indoor space.

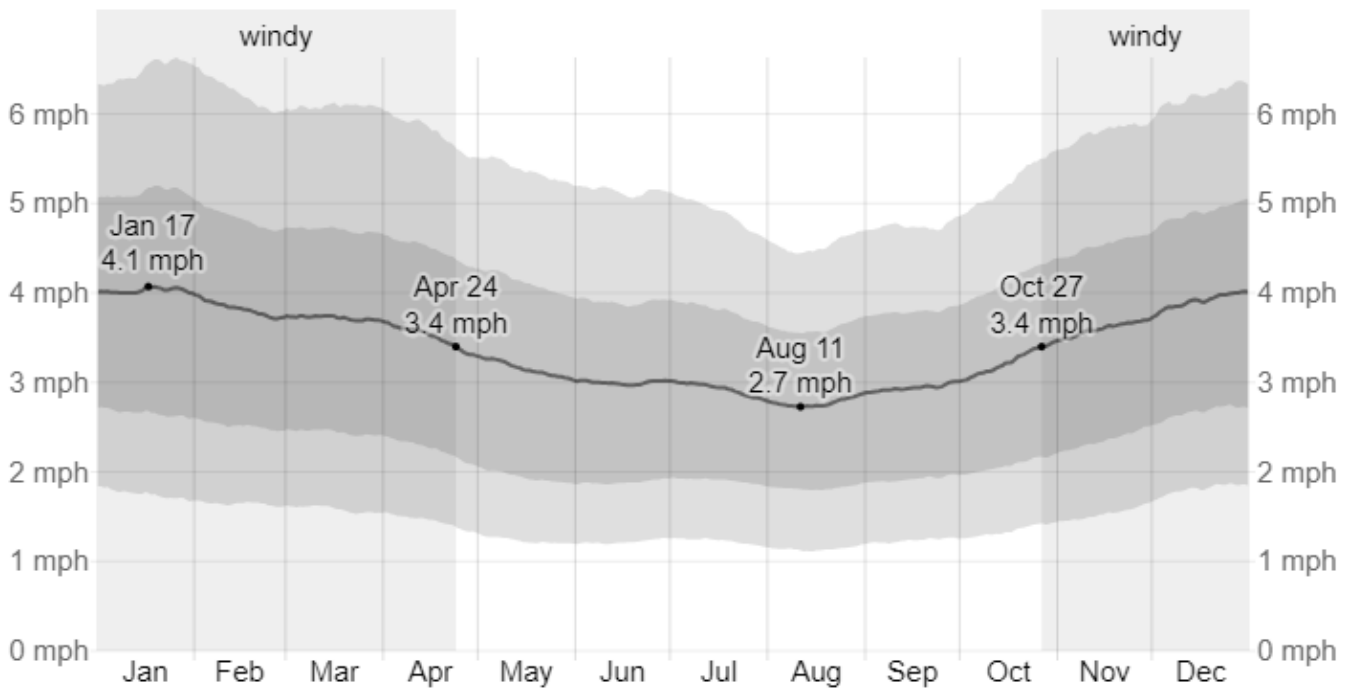

Fig.7 AVERAGE WIND SPEED IN INNSBRUCK

4 KPI Evaluation

4.1 Thermal Comfort KPIs

Hours of exceedance (HE) **127 h/year**
Hours outside the range of 26°C

Indoor Overheating Degree IOD **0.58 C**
Hourly summation of the positive values of the difference between the operative temperature of the occupied building thermal zones and the zonal thermal comfort limit temperature (26 C), divided by the sum of the zonal occupied hours.

Ambient Warmness Degree AWD **28.69 C**
Hourly summation over the summertime period of the positive values of the difference between the outdoor air temperature and a fixed base temperature (18 C), divided by the total number of building occupied hours.

Overheating Escalation Factor OEF **0.02**
An indicator of the resistivity of a building to climate change and associated overheating risk.

4.2 Heat stress KPIs

Standard Effective Temperature (SET) **25.3 C**
The equivalent dry bulb temperature of an isothermal environment at 50% relative humidity, still air and 50% relative humidity, in which a subject wearing clothing standardized for the activity concerned, would experience the same heat stress and thermoregulatory strain as in the actual test environment

Passive Survivability **Yes (hourly)**
Ability to maintain safe indoor thermal conditions in the absence of active cooling

4.3 Energy

As this project relies on cooling via window ventilation only, no energy is used on site for space cooling. Thus, the annual cooling load is equal to zero.

Annual cooling load intensity **0.0 kWh/m²a**
Annual cooling load intensity

Annual cooling site energy use intensity **0.0 kWh/m²a**
Annual cooling site energy use intensity

4.4 Carbon Dioxide (CO₂) Emissions

Annual amount of CO₂ emissions **0.0 gCO₂/m².a**
Annual electricity use for space cooling is 0 kWh/a, and the carbon dioxide (CO₂) emissions factor for electricity is 0.227 kg CO₂/kWh (OIB-Richtlinie-6, 2019).

5. Performance Evaluation

5.1 Energy

Monthly balance of energy producers

Figure 8 shows the monthly balance of the energy producer in the time period from September 2019 to August 2020. The monthly electricity grid supply during the regular operating months is constant at around 2,000 kWh per month. The supply of district heating follows the seasonal outdoor temperature curve. Furthermore, a lower consumption of electric energy during the lockdown period from March 2020 to the end of May 2020 and in July (closed for two weeks due to summer holidays) is visible.

Monthly balance energy producer

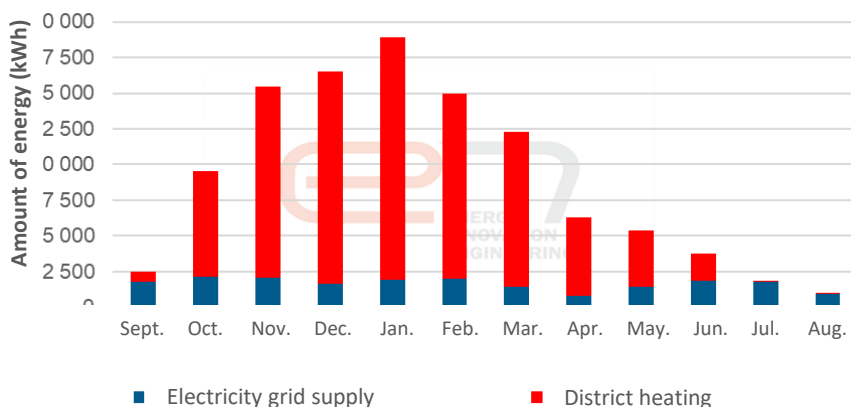

Fig.8 ENERGY BALANCE ENERGY PRODUCER, KINDERGARTEN ST. PAULUS

Energy consumption for heating

82 % of the total energy consumption is for heating. The total heating consumption from September 2019 to August 2020 amounts to 88,700 kWh or 88.8 kWh/m²a. The calculated heating energy consumption is 66 kWh/m²a. The measured value is therefore approximately 34 % higher than the calculated value. After an adjustment for the HDD (heating degree days), the heating energy consumption amounts to 82.4 kWh/m²a. The heat is supplied by district heating and distributed via underfloor heating regulated by room thermostats with zone and time control. The hot water supply is decentralized with six electric water heaters, so that the energy consumption of the hot water supply is allocated to the electricity supply share. During periods when the kindergarten was closed, the building was still heated. It can be assumed that the heating demand during these periods was higher than usual due to the lack of internal heat gains.

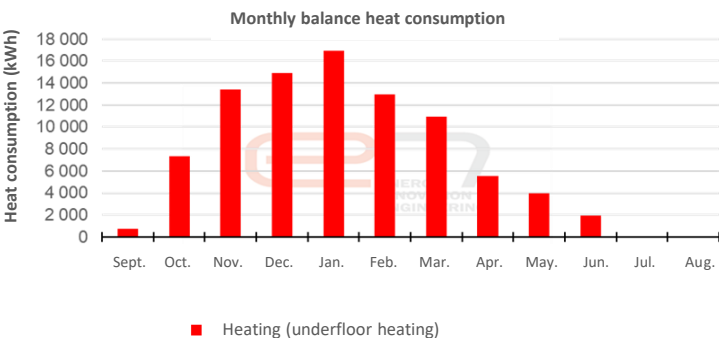

Fig.9 MONTHLY CONSUMPTION HEAT, KINDERGARTEN ST. PAULUS

Allocation consumption

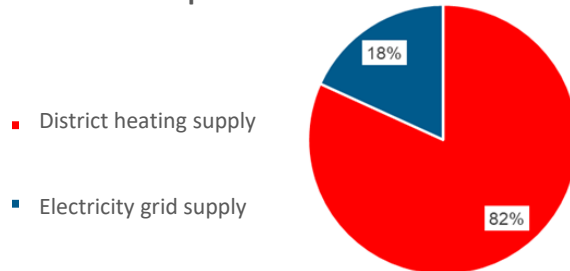

Fig.10 CONSUMPTION BREAKDOWN, KINDERGARTEN ST. PAULUS

Energy consumption for cooling

The energy consumption of cooling consists mainly of the power consumed by the automated window ventilation control and the power consumed by the motors of the window openers. These parameters have not been measured separately but are included in the measurements of the operating current. It can be assumed that the energy demand of the cooling system only accounts for a small proportion of the operating current.

Power consumption and benchmarks

The share of heating technology, which mainly consists of the consumption of circulation pumps, accounts for 3% of the total electricity consumption, with a specific energy consumption of 0.6 kWh/m²a. The share of operating electricity, with a specific energy consumption of 19.2 kWh/m²a, is 97%.

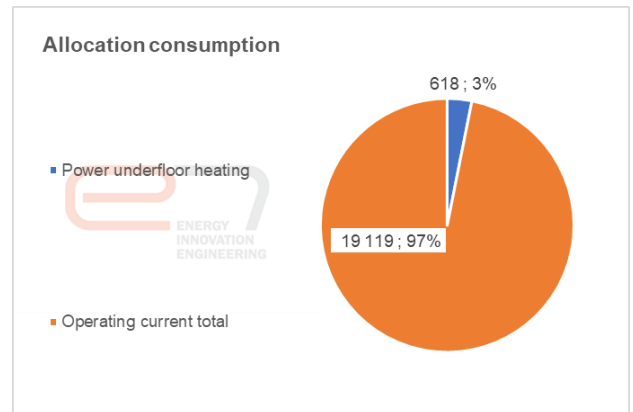

Fig.11 ALLOCATION POWER CONSUMPTION PER YEAR IN kWh/a, KINDERGARTEN ST.PAULUS

Performance Evaluation

Table.5 AIR TEMPERATURE AND HUMIDITY

Measurement period: 01 September 2019 - 31 August 2020			
Reference room	No. 1	No. 2	
Average room temperature in the heating period (temperature outside < 12°C)	23.7	22.5	°C
Average room temperature in the summer months (temperature outside > 12°C)	23.7	22.8	°C
Average indoor air humidity in the heating period (temperature outside < 12°C)	34.6	34.3	%
Share of overheating hours (T > 26°C) in the total number of annual hours	3	0	%

5.2 Comfort

Two rooms were chosen as reference rooms. Reference room No. 1 is “1. OG Gruppenraum Ost”, a room for a kindergarten group, located on the 1st floor and facing east. Reference room No. 2 is “EG Gruppenraum Ost”, also a room for a kindergarten group but located on the ground floor, facing east

CO2 monitoring

The CO2 concentration in parts per million of the two measuring points is shown in figure 12. The green area marks the range between the first and third quartile, the lines mark the range between minimum and maximum value.

The CO2 monitoring shows, that the indoor air quality in the two group rooms during the main operating hours in the morning often lie in a low range. These values coincide with many published measurement results of classrooms and kindergarten rooms, equipped with mechanical ventilation.

Boxplot diagram CO2 concentration

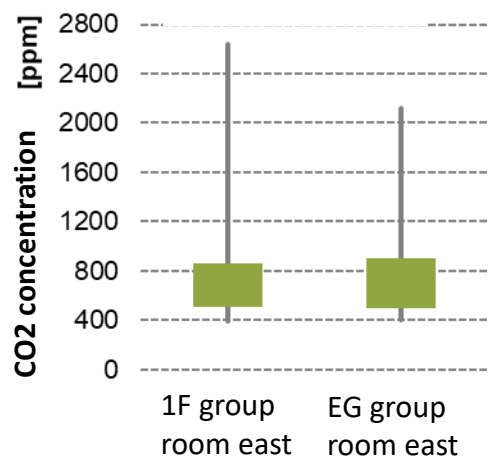

Fig.12 CO2 CONCENTRATION, KINDERGARTEN ST. PAULUS

Indoor humidity and indoor air temperature

As seen in figure 13, the parameters of indoor humidity and air temperature are almost always within the comfort zone. Most of the parameters outside of the comfort zone occurred during the holidays when the kindergarten was closed. As the ventilation is time-controlled and not regulated by difference between indoor and outdoor air temperature, there is a further unused cooling potential, which makes it possible to cool the indoor air temperature further if necessary.

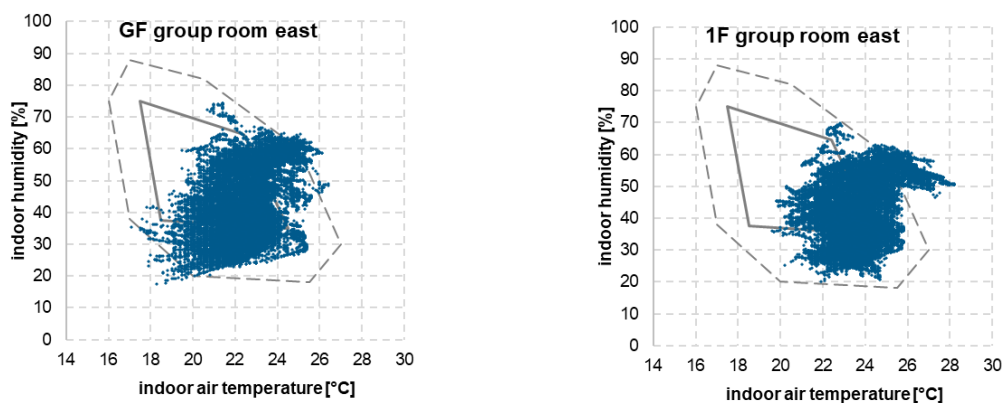

Fig.13 COMFORT PARAMETERS ROOM TEMPERATURE AND RELATIVE HUMIDITY, KINDERGARTEN ST.PAULUS

6. Discussion, Lessons Learned

6.1 Summary

Simple, flexible and effective cooling method

Relying on window ventilation for space cooling is a simple and effective cooling method. This simple design provides free cooling to the building. In addition, the system allows for flexibility as the windows can also be operated manually outside of the regular operating hours.

6.2 Optimization potential

Reduction of heating energy demand

- The monitoring data show that the building is continuously heated outside the periods of use (weekends and holidays). The air temperatures in the reference rooms are kept within a relatively high range of 23 °C to 24 °C. Therefore, the following measures to reduce the heating demand are recommended:
 - Adjustments to the regulation of the heat output system: The regulation of the used room thermostats can be used with time-control. It should be possible to reduce the indoor air temperatures on weekends and holidays using the time-control. On weekends, a reduction of 1 K to 2 K is reasonable, while a reduction to 18 °C is recommended during holidays. It is important to start the heating in time at the end of the holidays.
 - Adjusting the time-control of the window ventilation so that it does not occur on Saturdays and Sundays.

Optimization proposals for increasing the indoor air quality

- Use of central window control: Implementing automatic shock ventilation sequences per time-control during operating days. A significant improvement in the indoor air quality can be achieved by several short shock ventilation sequences during the main operating hours between 8:00 am and 2:00 pm.
- Installation of ventilation lights in the kindergarten group rooms: A ventilation light is a small measuring and display device that can be installed in the group rooms. It measures the CO₂ concentration and indicates to the teacher by color (green, yellow, red) whether ventilation is necessary, recommended or not needed.

Optimization potential for cooling

- At current outdoor air temperatures, the time-controlled ventilation suffices to meet the cooling demand. The monitoring data shows that there is additional potential by regulating the ventilation according to the outdoor and indoor temperatures. With the current setting of the time-control, the ventilation is often not operating at times when the outdoor temperature is lower than the indoor temperature. This additional potential could be used in future hotter summers.

7. References & Key Contacts

7.1 References

ASHRAE, ANSI/ASHRAE Standard 169-2013, Climatic Data for Building Design. Atlanta: ASHRAE, 2013.

Lampersberger, P. (2021). “Demo light Impact-Monitoring und messtechnische Untersuchung von energieeffizienten Gebäuden”

P. Holzer. (2020). “Annex 80 - Resilient Cooling of Buildings Task Group Key Performance Indicators”

OIB-Richtlinie-6. (2019). Austrian Institute of Construction Engineers

Weatherspark.com: <https://weatherspark.com/y/70055/Average-Weather-in-Innsbruck-Austria-Year-Round>

7.2 Contacts

Company	Role	Contact
e7 energy innovation & engineering	Consultant	Paul Lampersberger paul.lampersberger@e-sieben.at +43 1 907 80 26 - 68
Marte.Marte Architekten ZT GmbH	Project Architect	architekten@marte-marte.com 0043 5522 35485

1. Introduction & Climate

1.1 Introduction

Completed in 2013, the building provides space for apartments, events and retail. It was built according to the most stringent energy standard in Austria and has won several awards as a result. In addition, special attention was paid to the use of HFC- and PVC-free materials for installations, windows and doors, as well as solar shading. The building has a gross floor area of around 6,000 m², including 39 flats and 1150 m² of shared space. Residents have access to a green roof terrace. In terms of mobility, the building is designed so that residents can walk, cycle or use public transport for as many journeys as possible.



Fig.1 EXTERIOR VIEW, WEST VIEW, RESIDENTIAL PROJECT VIENNA

1.2 Local Climate

Location: The building is located in an urban area with high density within the city of Vienna, Austria (48°13'33"N 16°23'42"E). One side of the building borders a public park.

Climate Zone: The building is located in a temperate climate zone (4A). This zone is characterized by warm to cool temperate climate.

Table.1 KEY INFORMATION ABOUT THE BUILDING

Location	Vienna, Austria
Building Type	Residential property with commercial space
Retrofit (Y/N)	N
Surroundings (Urban/Rural)	Urban
Year of Completion	2013
Floor Area (m²)	6,071
Building Volume (m³)	19,014
Shape factor (m)	3.19
Openable Area to Floor Area Ratio (%)	21.5 %
Window to Wall Ratio (%)	44.2%
Climate Zone	Temperate (4A)
No. of Days with Te max > 25	55
Cooling Season Humidity	68%
Heating Degree days 12/20 (Kd)	3,446

Climate Zone	Description
0A	Extremely Hot Humid
0B	Extremely Hot Dry
1B	Very Hot Humid
1A	Very Hot Dry
2A	Hot Humid
2B	Hot Dry
3A	Warm Humid
3B	Warm Dry
3C	Warm Marine
4A	Mixed Humid
4B	Mixed Dry
4C	Mixed Marine
5A	Cool Humid
5B	Cool Dry
5C	Cool Marine
6A	Cold Humid
6B	Cold Dry
7	Very Cold
8	Subarctic

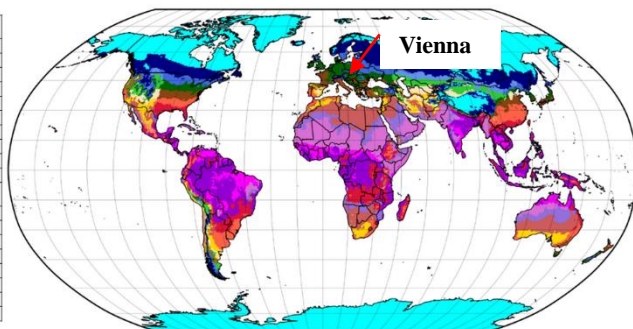

Fig.2 CLIMATE MAP (ASHRAE 169 - CLIMATE DATA FOR BUILDING DESIGN STANDARDS)

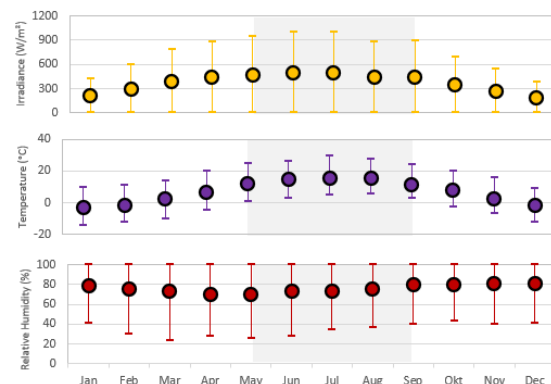

Fig.3 MEAN, MAXIMUM AND MINIMUM EXTERNAL CONDITIONS IN VIENNA, USING TMY3 FROM METEONORM 7. RADIATION MEASURED ON A HORIZONTAL SURFACE

2. Building

2.2 Energy Systems

Schematic design of energy system

Different systems are used for the energy supply. Electricity is supplied by a photovoltaic system and from the public grid. The building is heated by district heating. This applies to both space heating and hot water. Cooling is provided by using well water in combination with the ventilation. The entire building is ventilated.

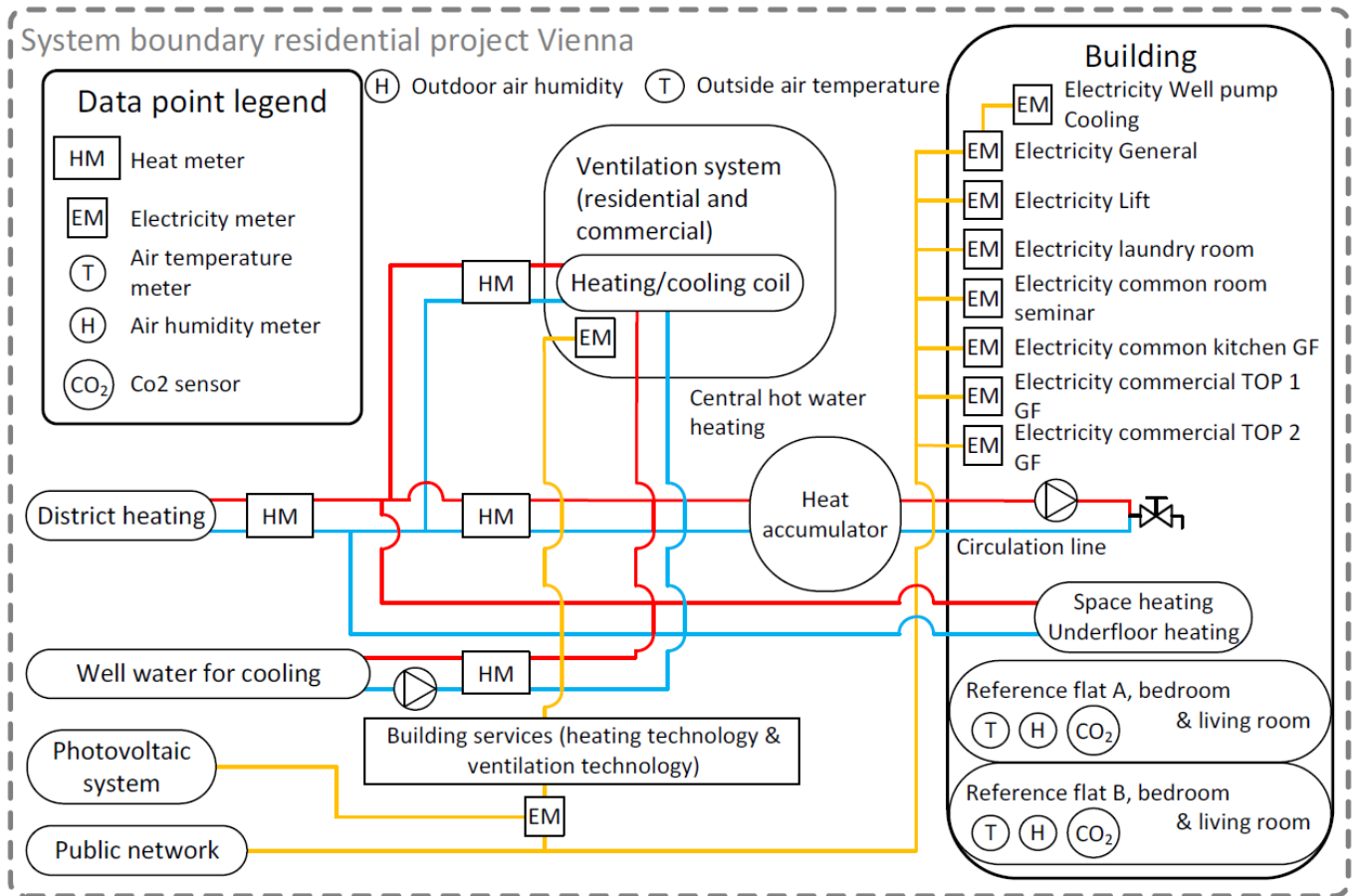

Fig.5 SCHEMATIC DIAGRAM OF THE VIENNA HOUSING PROJECT, BUILDING TECHNOLOGY AND MEASUREMENT CONCEPT

Description of Energy System

Heating System

The building is heated with district heating. A total of 269 kW has been connected to heat the building. As mentioned above, the district heating is also used for domestic hot water. This is done centrally for the entire building. For this purpose, 2 hot water tanks of 750 liters each have been installed.

Cooling System

The building is cooled via the ventilation. A cooling coil in the ventilation is supplied by well water cooling. The cooling by ventilation is used in summer to condition the supply air.

Electrical Power Supply

Electricity consumption is covered by the public grid and a PV system of 60 m², 10 kWp and 15° inclination. The electricity demand is made up of the household electricity demand and the electricity demand for the building services.

3. Resilient Cooling

3.1 Principles

In principle, the rooms are cooled by introducing conditioned supply air into the room. There is a cooling coil in the ventilation. The cooling coil is responsible for cooling down the air in the supply air. It is supplied with well water.

Ventilation of the building is used for controlled ventilation of rooms. To increase efficiency, a heat recovery system and a geothermal heat exchanger were installed. In order to promote thermal mass utilization, the building consists of a horizontal concrete structure.

Supply and exhaust air characteristics:

- Residential: 5,700/5,700 m³/h
- Commercial: 3,800/3,000 m³/h

3.2 Structure of resilient cooling technology

REMOVING HEAT FROM INDOOR ENVIRONMENT

Ventilation System

- Fans: The fan is responsible for introducing the cooled air into the room. It absorbs the fresh air and brings it to the room as supply air through all components in the supply air duct. In the extract air duct, the fan is responsible for extracting the return air from the room and exhausting it to the outside.
- Cooling coil: The cooling coil is responsible for lowering the temperature of the supply air. It is fed by the cold medium from the well cooling.
- Heat recovery: Heat recovery increases the efficiency of the system. It uses the heat or cold of the extract air to heat the fresh air in winter and to cool it in summer.

Well cooling:

With well cooling, cold groundwater is used for cooling. The groundwater is drawn in via an extraction well and fed into the cooling circuit. It is then fed back into the groundwater system through the injection well.

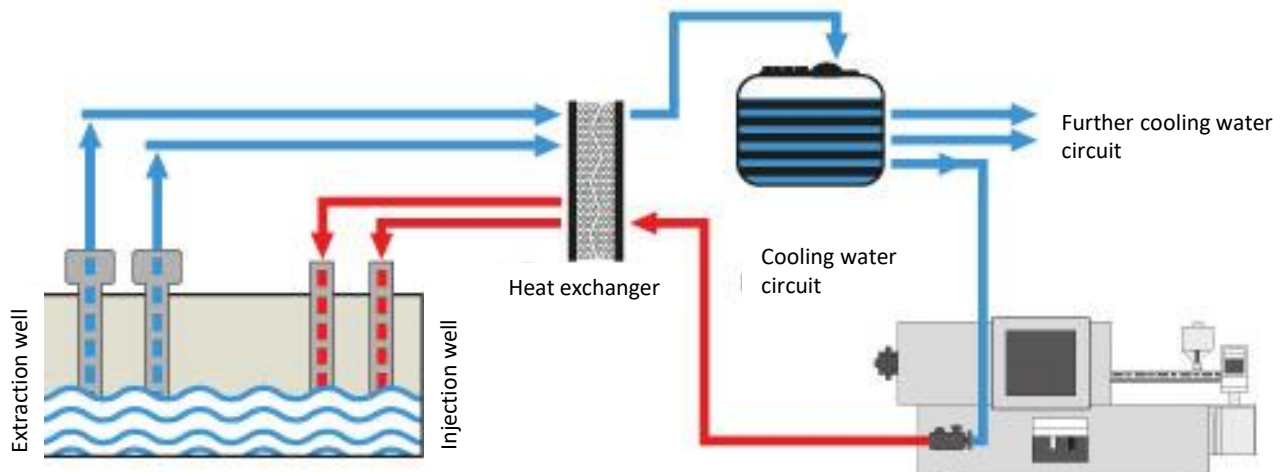

Fig.6 SCHEMATIC OF A WELL COOLING SYSTEM ([HTTPS://WWW.IKS-KUEHLUNG.DE/](https://www.iks-kuehlung.de/))

Table.4 STRUCTURE OF THE SYSTEM

1. Reducing heat loads to people and indoor environments	
1.1.	Advanced solar shading
1.2.	Advanced cool materials
1.3.	Advanced glazing technologies
1.4.	Ventilated façades
1.5.	green roofs, green façades
2. Removing heat from indoor environments (production, emission and combined)	
2.1.	Ventilative cooling
2.2.	Thermal mass utilization
2.3.	Evaporative cooling
2.4.	Sky radiative cooling
2.5.	Compression refrigeration machines
2.6.	Adsorption chillers
2.7.	Natural heat sinks
2.8.	Radiant Cooling
3. Increasing personal comfort apart from space cooling	
3.1.	Comfort ventilation and elevated air movement
3.2.	Micro-cooling and personal comfort control
4. Removing latent heat from indoor environments	
4.1.	Dehumidification

4. KPI Evaluation

4.1 Thermal Comfort KPIs

Hours of exceedance (HE) **1245 h/year**

Hours outside the range of 26°C

Indoor Overheating Degree IOD **0.393 C**

Hourly summation of the positive values of the difference between the operative temperature of the occupied building thermal zones and the zonal thermal comfort limit temperature (26 C), divided by the sum of the zonal occupied hours.

Ambient Warmness Degree AWD **3.57 C**

Hourly summation over the summertime period of the positive values of the difference between the outdoor air temperature and a fixed base temperature (18 C), divided by the total number of building occupied hours.

Overheating Escalation Factor OEF **0.11**

An indicator of the resistivity of a building to climate change and associated overheating risk.

4.2 Heat Stress KPIs

Standard Effective Temperature (SET) **25.2 C**

The equivalent dry bulb temperature of an isothermal environment at 50% relative humidity, still air and 50% relative humidity, in which a subject, while wearing clothing standardized for activity concerned, would have the same heat stress and thermoregulatory strain as in the actual test environment.

Passive Survivability **Yes (hourly)**

Ability to maintain safe indoor thermal conditions in the absence of active cooling

4.3 Energy

Annual cooling load intensity **0.63 kWh/m²a**

Annual cooling load intensity

Annual cooling site energy use intensity **1.52 kWh/m²a**

Annual cooling site energy use intensity

Peak cooling site power demand **2.12 W/m²**

peak cooling site power demand

SCOP **0.40**

Seasonal coefficient of performance

4.4 Carbon dioxide (CO₂) emissions

Annual amount of CO₂ emissions **143.01 gCO₂/m².a**

Annual electricity use for space cooling is 3,800 kWh/a (i.e. 0.63 kWh/(m².a) for 6,071 m² conditioned floor area), and the carbon dioxide (CO₂) emissions factor for electricity is 0.227 kg CO₂/kWh (OIB-Richtlinie-6, 2019).

5. Performance Evaluation

5.1 Energy

Monthly balance of energy producers

Figure 7 shows the monthly balance of the energy producers from September 2019 to August 2020. The electricity supply for the building services and common areas is provided by the photovoltaic system on the one hand, and by electricity purchased from the grid on the other. Any surplus electricity generated by the photovoltaic system is fed into the public grid. The electricity supply for common areas and building services accounts for 14% of the total energy consumption of the building, while the PV system's own consumption accounts for 2%. Heating for the Vienna housing project is provided by district heating (83% of the total energy consumption) and cooling is provided by well water (% of the total energy consumption).

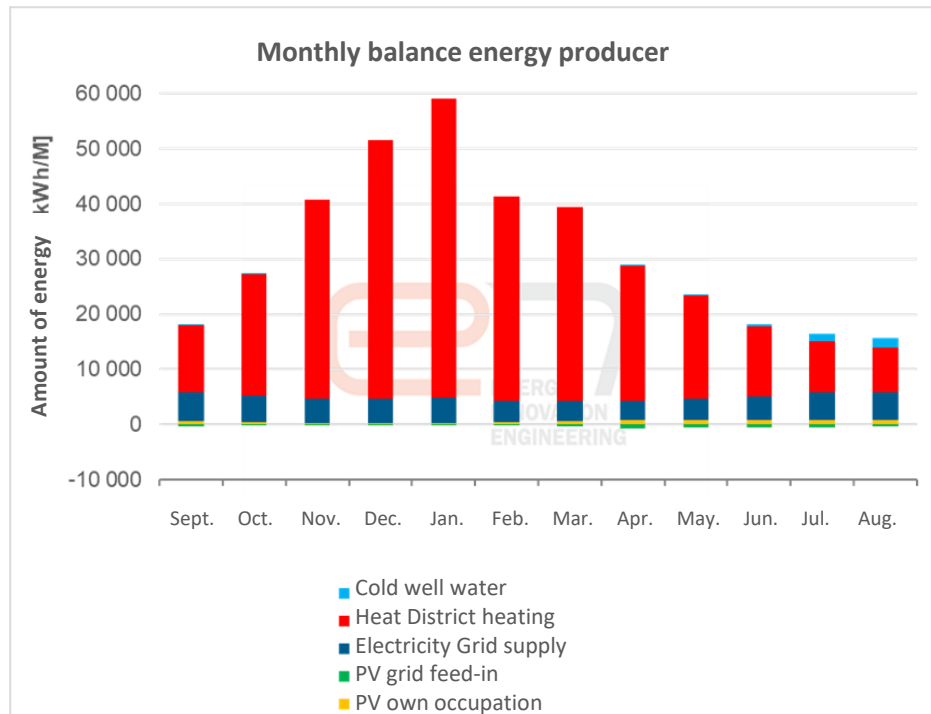

Fig.7 ENERGY BALANCE ENERGY PRODUCER, VIENNA HOUSING PROJECT

Energy consumption for heating

The total heat consumption in the measurement period September 2019 - August 2020 is around 317,700 kWh.

The measured specific heating energy consumption is 52.2 kWh/m²a. After an adjustment of the HDD (heating degree days), the heating energy consumption is 55 kWh/m²a. The measured heating energy consumption thus corresponds very closely to the calculated heating energy consumption of the energy performance certificate (52.1 kWh/m²a). The building is heated exclusively by district heating. Figure 8 below shows the monthly heat demand structure.

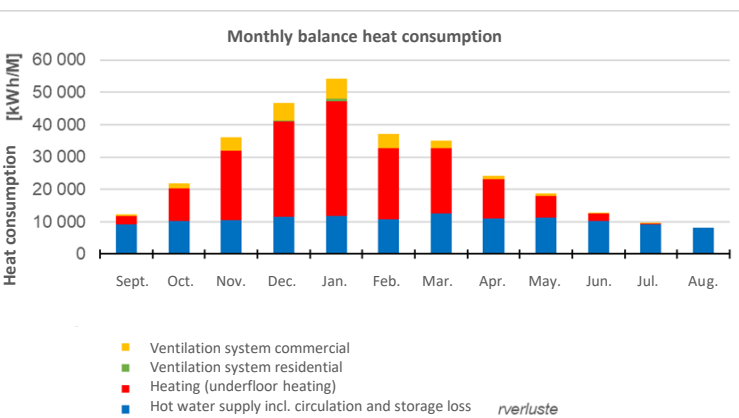

Fig.8 MONTHLY CONSUMPTION HEAT, VIENNA HOUSING PROJECT

Allocation consumption

- Hot water supply incl. circulation and storage loss
- Heating (underfloor heating)
- Ventilation system residential
- Ventilation system commercial

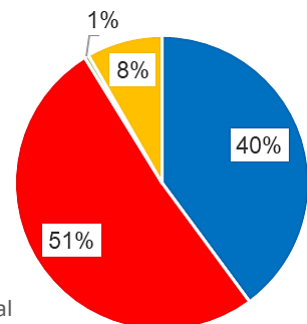

Fig.9 CONSUMPTION BREAKDOWN, VIENNA HOUSING PROJECT

5. Performance Evaluation

Energy consumption for cooling

The total cooling consumption in the measurement period September 2019 to August 2020 is around 3,800 kWh. 64% of this can be attributed to the residential ventilation system and 36% to the commercial ventilation system. As expected, higher specific cooling quantities are required in the commercial sector than in the residential sector. This can be explained by the fact that the target supply air temperature is lower in the commercial sector (22.2°C) than in the residential sector (24°C).

Figure 10 shows the monthly cooling demand structure. It clearly shows that the supply air cooling demand is predominantly in the period from June to August.

The monitoring data also shows that the cooling capacities demanded for both ventilation systems amount to a maximum of 50% of the design capacity of the cooling coils. This suggests that there is still potential for more intensive supply air conditioning during hot spells.

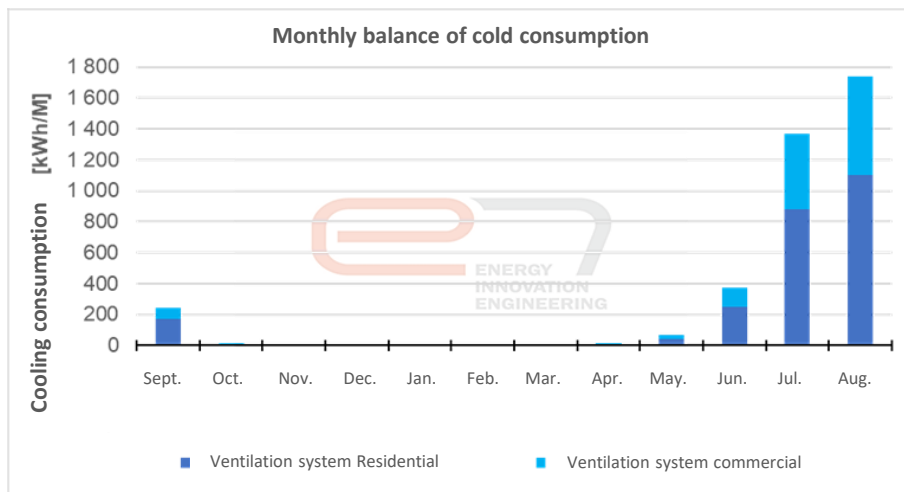

Fig.10 MONTHLY CONSUMPTION COLD, VIENNA HOUSING PROJECT

Power consumption and benchmarks

For the residential project in Vienna, all electricity consumption for common areas and building services was recorded. Household electricity consumption was not determined.

During the measurement period the total electricity consumption of the common areas and building services was around 59,650 kWh, or 9.8 kWh/m² of gross floor area. The maximum reference power of the 15-minute values is approximately 19.6 kW, or 3.2 W/m² of gross floor area. The electricity base load for common areas and building services is approximately 4.8 kW, resulting in an annual base load consumption of around 41,900 kWh (70% of the total electricity consumption). A significant portion of the base load is caused by the ventilation systems, which have a constant electricity consumption throughout the year.

A photovoltaic system with a nominal output of 9.9 kWp is located on the flat roof of the building. The system generated a specific annual yield of 1,044 kWh/kWp during the measurement period (September 2019 to August 2020). For the present module inclination of 15°, the yield can be considered very good.

The PV yields are used to supply the building services (65% of the PV yield), with the surplus electricity (35%) fed into the public grid.

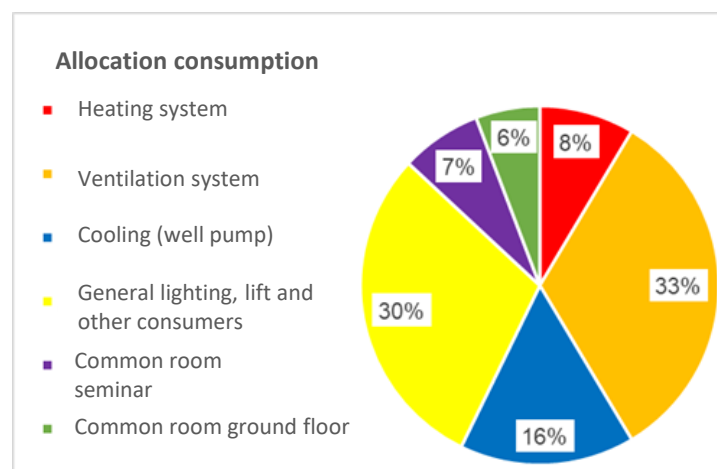

Fig.11 MONTHLY CONSUMPTION COLD, VIENNA HOUSING PROJECT

5. Performance Evaluation

5.2 Comfort

The bedrooms and living rooms of 2 flats were used as reference rooms for the comfort and CO₂ monitoring:

- No. 1 living room and No. 2 bedroom: 1st floor flat A, north/west orientation, useful living area approx. 100 m².
- No. 3 living room and No. 4 bedroom: 1st floor flat B, south orientation, useful living area approx. 50 m².

In general, for all reference rooms, the comfort parameters during the heating period are largely in the comfortable range. However, the indoor air humidity is often below the optimal range for living rooms and bedrooms (40-60%).

Table.5 CO₂-CONCENTRATION

Measurement period: 01 September 2019 - 31 August 2020					
Reference room	No. 1	No. 2	No. 3	No. 4	
Average room temperature in the heating period (temperature outside < 12°C)	23,1	22,5	23,8	22,4	°C
Average room temperature in the summer months (temperature outside > 12°C)	24,4	25,3	25,5	25,2	°C
Average indoor air humidity in the heating period (temperature outside < 12°C)	28,1	28,2	31,7	33,1	%
Share of overheating hours (T > 26°C) in the total number of annual hours	7%	18%	16%	15%	%
Share of CO ₂ concentration (CO ₂ > 1000ppm) in the total number of annual hours	4%	26%	1%	1%	%

CO₂ monitoring

Figure 12 shows the CO₂ concentration of the reference areas as a box plot. The green area delimits the range between the first and third quartiles, the lines show the range between the minimum and maximum values.

The CO₂ monitoring shows that the living rooms have good indoor air quality all year round. When comparing the bedrooms, it is noticeable that in bedroom A (reference room no. 2) there is regularly an increased CO₂ concentration (800 to max. 1,600 ppm) during the night hours. The indoor air quality during the night hours is therefore considered to be moderate.

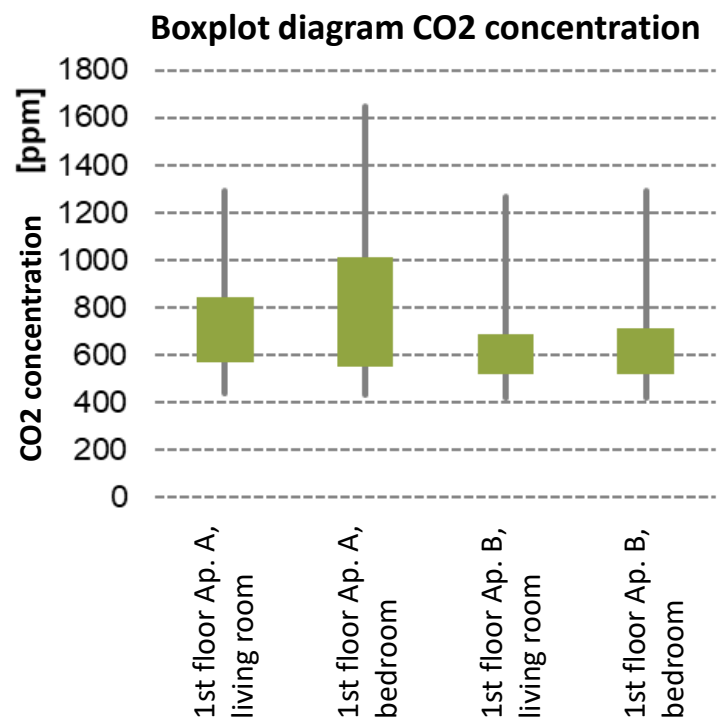

Fig.12 MONTHLY CONSUMPTION COLD, VIENNA HOUSING PROJECT

6. Discussion, Lessons Learned

6.1 Summary

Easy and effective cooling method

If the building has a ventilation system, it is easy and very cost-effective to expand the ventilation with a free cooling unit based on a water well.

6.2 Optimisation potential

Reduction of heating energy demand

- By lowering the heating limit temperature in the room heating control, it is possible to save heating energy during the transitional periods of spring and autumn. It is recommended to check the current setting and to make adjustments during a trial period. Furthermore, it is recommended to lower the supply air temperature of both the commercial and residential ventilation systems by 1 to 2 K during the heating period.

Operating time of the ventilation system serving the commercial space.

- The monitoring data show that the commercial ventilation system operates all year round without a timer program. According to the type of use, the possibility of switching off this ventilation system outside the hours of use (night hours, weekends and holidays) should be considered. Electricity savings of 50% can be expected by switching the system to demand controlled operation. In addition, district heating consumption and system maintenance costs will be reduced.

Cooling with well water

- When considering the electricity costs for the well pump of the cooling system, it becomes clear that the annual performance factor of the cooling solution (ratio of useful cooling to electrical energy used over the period of one year) is relatively low at 0.4. This is due to the high running time of the well pump. It is recommended to optimise the control of the well pump. The well pump should only be activated when one of the two ventilation systems requires cooling. Otherwise, the pump should be switched off.

Increasing the use of onsite photovoltaic power

- The photovoltaic yields are used to supply the building services. During the measurement period, 65% of the PV yield was used internally. The electricity surplus of 35% of the yield was fed into the public grid. By changing the connection of the well pump to the building services supply line, the PV internal electricity use can be increased to approximately 85%. In addition, the power supply for the lift could also be connected to the building services billing meter and the "lift" billing meter could be disconnected from the electricity grid operator.

Optimising indoor comfort in summer and increasing energy efficiency by adapting ventilation behaviour

- In order to reduce the overheating of the apartments in summer, the existing shading could be better controlled using automatic controls or programmed to operate according to a schedule.
- The measurement data from the reference rooms indicate that in one reference flat in particular, window ventilation is very frequent for several hours in the morning during the heating period. This leads to strong cooling of the rooms and thus to heat loss. In terms of energy efficiency, ventilation by means of intermittent ventilation (5 to 10 minutes) is recommended.
- The monitoring data for the summer months show that the cooling capacities required for both ventilation systems amount to a maximum of 50% of the design capacity of the cooling coils.
- By lowering the air supply setpoint for the ventilation systems during hot spells, a higher cooling contribution could be achieved by the ventilation systems in the residential and/or commercial areas.

7. References & Key Contacts

7.1 References

ASHRAE, ANSI/ASHRAE Standard 169-2013, Climatic Data for Building Design. Atlanta: ASHRAE, 2013.

Lampersberger, P. (2021). “Demo light Impact-Monitoring und messtechnische Untersuchung von energieeffizienten Gebäuden”

Web: <https://nachhaltigwirtschaften.at/en/sdz/projects/delight-monitoring.php>

Download: https://nachhaltigwirtschaften.at/resources/sdz_pdf/schriftenreihe-2021-10-delight-monitoring.pdf

P. Holzer. (2020). “Annex 80 - Resilient Cooling of Buildings Task Group Key Performance Indicators”

OIB-Richtlinie-6. (2019). Austrian Institute of Construction Engineers.

7.2 Interesting Links and Downloads

Website of Wohnprojekt Wien, in German: <https://wohnprojekt.wien/>

Website of Wohnprojekt Wien by architects einszueins architecture, in German:

<https://www.einszueins.at/project/wohnprojekt-wien/>

Website of non-profit architecture website nextroom, in German:

<https://www.nextroom.at/building.php?id=36753&inc=datenblatt>

7.3 Contacts

Company	Role	Contact
e7 energy innovation & engineering	Consultant Measuring energy use during operation of building	Paul Lampersberger paul.lampersberger@e-sieben.at www.e-sieben.at +43 1 907 80 26 - 68
einszueins architektur ZT GmbH	Project Architect	office@einszueins.at www.einszueins.at
RWT Plus	Structural design, building physics, building technology	office@rwt.at www.woschitzgroup.com/
DnD Landschaftsplanung	Landscape architecture	office@dnd.at www.dnd.at
Raum & Kommunikation	Project controlling	office@raum-komm.at www.raum-komm.at

1. Introduction & Climate

1.1 Introduction

The gym Sporthalle Liefering is located on the west side of the Salzach River in the Liefering district of the city of Salzburg. The gross floor area is 4,610 m² and the gym has four stories, a football field, an outdoor area and a reserve sports area. The project's construction meets the Plus Energy standard. This means that the balance between imported and exported thermal and electric energy is negative. The building is constructed using reinforced concrete and a solid timber frame. The massive base plate is a crucial element of the TABS (Thermal Activation Building System). It was installed for flood protection and its mass is used in combination with the solar thermal system and well water cooling.



Fig.1 SPORTHALLE LIEFERING EXTERIOR VIEW (SOURCE: CITY OF SALZBURG / JOHANNES KILLER)

1.2 Local Climate

Location: The building is located in the Josef-Brandstätter-Straße 9, 5020 Salzburg, with the coordinates 47° 48' 0" N, 13° 2' 0" E.

Climate Zone: The building is located in a temperate climate zone (5A). This zone is characterized by warm to cool temperate climate.

Climate Zone	Description
0A	Extremely Hot Humid
0B	Extremely Hot Dry
1A	Very Hot Humid
1B	Very Hot Dry
2A	Hot Humid
2B	Hot Dry
3A	Warm Humid
3B	Warm Dry
3C	Warm Marine
4A	Mixed Humid
4B	Mixed Dry
4C	Mixed Marine
5A	Cool Humid
5B	Cool Dry
5C	Cool Marine
6A	Cold Humid
6B	Cold Dry
7	Very Cold
8	Subarctic

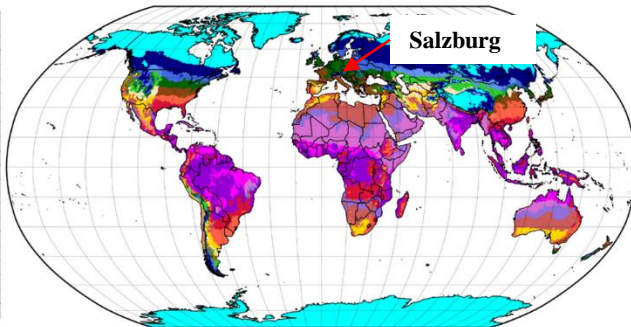

Fig.2 CLIMATE MAP (ASHRAE 169 - CLIMATE DATA FOR BUILDING DESIGN STANDARDS)

Table.1 KEY INFORMATION ABOUT THE BUILDING

Location	Salzburg, Austria
Building Type	Gym
Retrofit (Y/N)	N
Surroundings (Urban/Rural)	Rural
Year of Completion	2017
Floor Area (m²)	4,610
Shape Coefficient (m)	3.89
Openable Area to Floor Area Ratio (%)	22.4
Window to Wall Ratio (%)	21%
Climate Zone	Temperate (5A)
No. of Days with Te max > 25	68
Cooling Season Humidity	70%
Heating Degree days 12/20 (Kd)	2,741

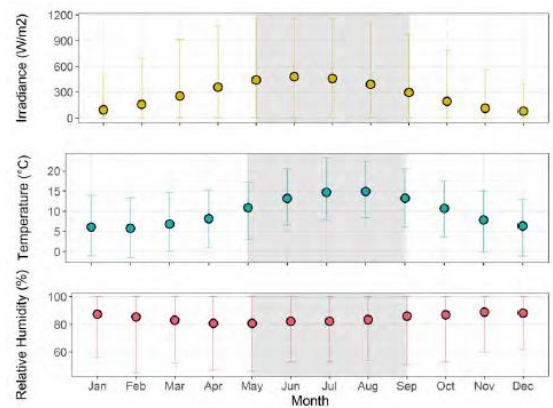

Fig.3 MEAN, MAXIMUM AND MINIMUM EXTERNAL CONDITIONS IN SALZBURG, USING TMY3 FROM METEONORM 7. RADIATION MEASURED ON A HORIZONTAL SURFACE

Building Information

2. Building

2.1 Envelope and Construction

Special features of the building envelope and construction

- Heavy construction: reinforced concrete and solid timber frame construction
- 3- pane glazing
- 4 stories
- Compact construction, $A/V = 0.26 [1/m]$, shape factor $3.89 [m]$
- 55 cm base plate and ceilings are used as heat accumulators for Thermal Activation Building Component Systems (TABS)

Table.2 INFORMATION PLANNING, OPERATION AND USE

Information on planning, operation and use

Object use	Rental Owner: SIG – Salzburg Immobilien Gesellschaft Renter: The city of Salzburg
Integral planning process	The energy concept was finalized before the project was open to bid. All competing teams had to adhere to the requirements of the energy concept
Technical management	Internal management and external monitoring
Energy monitoring	Own energy monitoring system

Table.3 BUILDING PROPERTIES

Property	Unit	Value
Hours of occupancy (office)	h/week	40
Hours of occupancy (sports hall)	h/week	98
Window U-value	W/(m ² K)	0.85
Window g-value	-	0.5
Wall U-value	W/(m ² K)	0.14
Roof U-value	W/(m ² K)	0.09
Floor U-value	W/(m ² K)	0.16
Window to Wall Ratio	%	21%
Air-tightness (@50 Pa)	1/h	0.6



Fig.4 SPORTHALLE LIEFERING INDOOR VIEW (SOURCE: CITY OF SALZBURG / JOHANNES KILLER)

Energy System

2. Building

2.2 Energy Systems

Schematic design of energy system

The energy system consists of several sources. Cooling is provided by night ventilation, and if additional cooling is required, this can be supported by the use of well water. Heating is provided by the solar thermal system in combination with a water/water heat pump. Domestic hot water is centrally heated via heat accumulator. Electricity is supplied by a photovoltaic system and from the public grid.

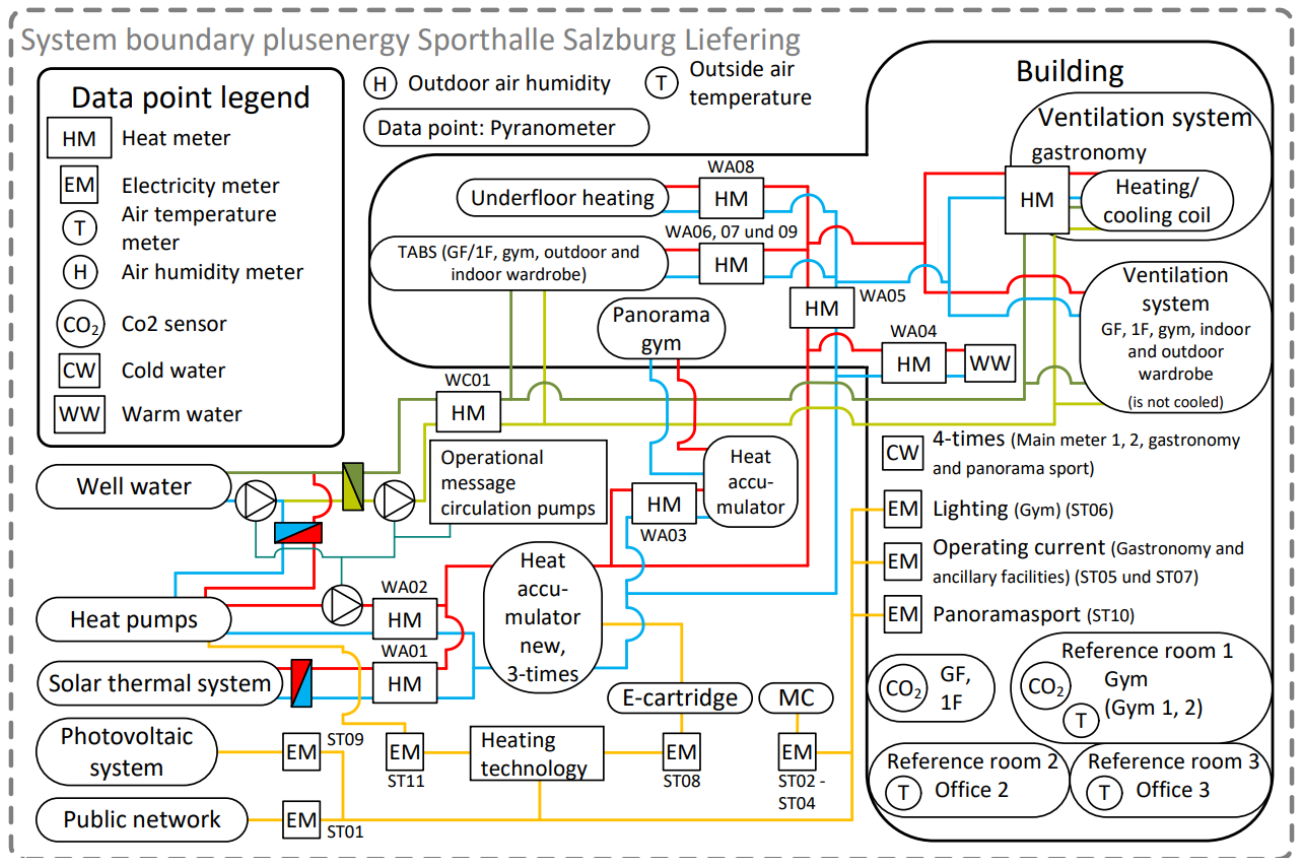

Fig.5 SCHEMATIC DIAGRAM OF THE SPORTHALLE LIEFERING, BUILDING TECHNOLOGY AND MEASUREMENT CONCEPT

Description of Energy System

Heating System

The building is heated by a solar thermal system with an aperture area of 350 m² combined with a water/water heat pump (56 kW). The system includes a buffer tank with a capacity of 15,000 liters and two electric cartridge heaters of 45 kW each.

Cooling System

The building is cooled via the ventilation. If required, additional cooling can be provided by using the well water to cool the ventilation supply air.

Electrical Power Supply

Electricity is supplied by a 110 kWp PV system and the public grid. Surplus power is supplied to the adjacent building yard of the city of Salzburg.

Resilient Cooling

3. Resilient Cooling

3.1 Principles

The building has been designed to reduce the cooling demand to a minimum. This is achieved by the compact and heavy construction combined with night cooling for the TABS and controlled shading. When the cooling demand is low, heat can be stored in the storage mass during the day and be cooled via window ventilation with the cold outside air at night. Higher cooling demands can be covered via well cooling (73 kW). The cold groundwater is used for TABS and to cool the supply air of the ventilation system.

3.2 Structure of resilient cooling technology

Table.4 STRUCTURE OF THE SYSTEM

1. Reducing heat loads to people and indoor environments	
1.1.	Advanced solar shading
1.2.	Advanced cool materials
1.3.	Advanced glazing technologies
1.4.	Ventilated façades
1.5.	green roofs, green façades
2. Removing heat from indoor environments (production, emission and combined)	
2.1.	Ventilative cooling
2.2.	Thermal mass utilization
2.3.	Evaporative cooling
2.4.	Sky radiative cooling
2.5.	Compression refrigeration machines
2.6.	Adsorption chillers
2.7.	Natural heat sinks
2.8.	Radiant Cooling
3. Increasing personal comfort apart from space cooling	
3.1.	Comfort ventilation and elevated air movement
3.2.	Micro-cooling and personal comfort control
4. Removing latent heat from indoor environments	
4.1.	Dehumidification

II REMOVING HEAT FROM INDOOR ENVIRONMENT

Ventilation System

- Low cooling demand: Window ventilation at night at lower outdoor temperatures (when the outdoor temperature is 2 degrees or more below the indoor temperature).
- At higher temperatures: The outdoor air is absorbed by the ventilation system and cooled via heat recovery from the exhaust air, then further cooled by the cold well water. The air is then introduced into the building as supply air.

Well cooling:

With well cooling, cold groundwater is used for cooling. The groundwater is drawn in via an extraction well and fed into the cooling circuit. It is then fed back into the groundwater system via the injection well.

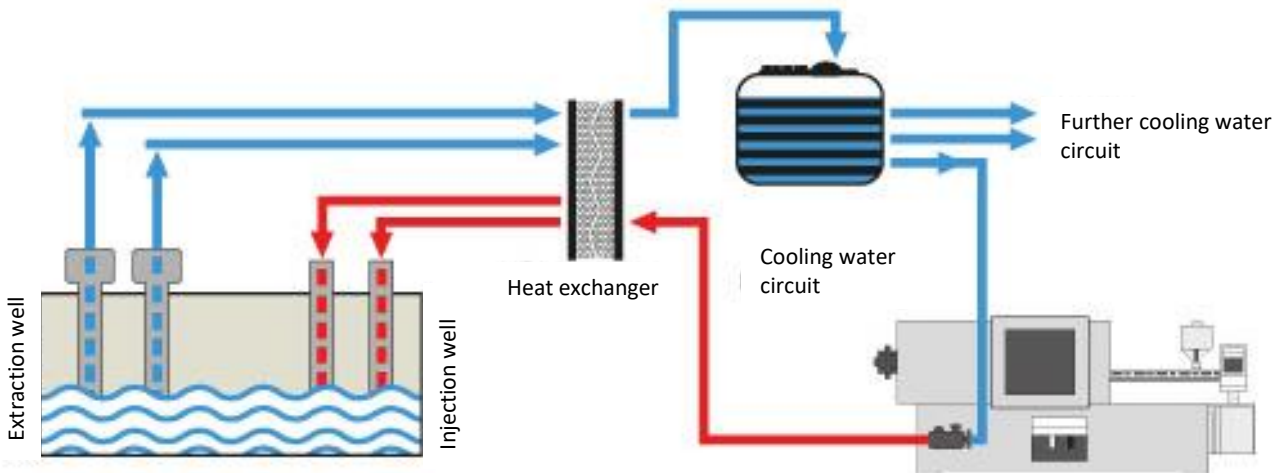

Fig.6 SCHEMATIC OF A WELL COOLING SYSTEM ([HTTPS://WWW.IKS-KUEHLUNG.DE/](https://www.iks-kuehlung.de/))

KPI Evaluation

4 KPI Evaluation

4.1 Thermal Comfort KPIs

Hours of exceedance (HE) **110 h/year**
Hours outside the range of 26°C

Indoor Overheating Degree IOD **0.078 C**
Hourly summation of the positive values of the difference between the operative temperature of the occupied building thermal zones and the zonal thermal comfort limit temperature, divided by the sum of the zonal occupied hours.

Ambient Warmness Degree AWD **8.29 C**
Hourly summation over the summertime period of the positive values of the difference between the outdoor air temperature and a fixed base temperature (18 C), divided by the total number of building occupied hours.

Overheating Escalation Factor OEF **0.009**
An indicator of the resistivity of a building to climate change and associated overheating risk.

4.2 Heat stress KPIs

Standard Effective Temperature (SET) **28.3 C**
The equivalent dry bulb temperature of an isothermal environment at 50% relative humidity, still air and 50% relative humidity, in which a subject, while wearing clothing standardized for activity concerned, would experience the same heat stress and thermoregulatory strain as in the actual test environment.

Passive Survivability **Yes (hourly)**
Ability to maintain safe indoor thermal conditions in the absence of active cooling

4.3 Energy

Annual cooling load intensity **12.1 kWh/m²a**
Annual cooling load intensity

Annual cooling site energy use intensity **13 kWh/m²a**
Annual cooling site energy use intensity

4.4 Carbon dioxide (CO₂) emissions

Annual amount of CO₂ emissions **2,951 gCO₂/m².a**
Annual electricity use for space cooling is 59,909 kWh/a (i.e. 13 kWh/(m².a) for 4,610 m² conditioned floor area), and the carbon dioxide (CO₂) emissions factor for electricity is 0.227 kg CO₂/kWh (OIB-Richtlinie-6, 2019).

5. Performance Evaluation

5.1 Energy

Monthly balance of energy producers

Figure 7 shows the monthly balance of the energy producers from March 2019 to February 2020. Electricity is supplied by the photovoltaic system and the public grid. Surplus electricity from the photovoltaic system is fed into the public grid and the adjacent building yard. The energy for heating is provided by a solar thermal system, a heat pump and an electric heating rod. Excess heat is stored in the concrete core and used between November and February. The monitoring data showed that despite the project being designed as plus energy, over the measurement period there was indeed a surplus of heat produced by the project (8000 kWh surplus) but the electricity balance was negative (around 45000 kWh negative balance).

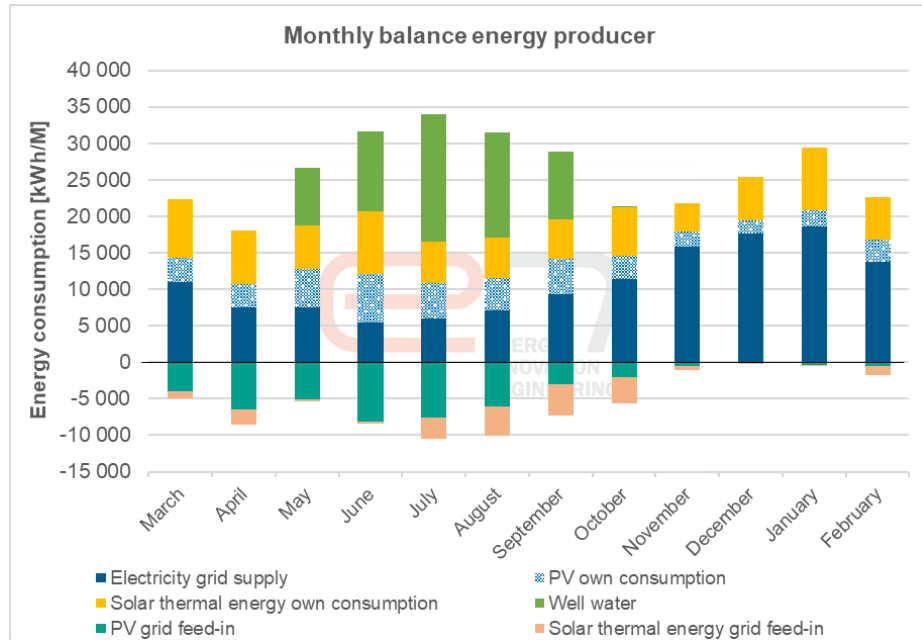

Fig.7 ENERGY BALANCE ENERGY PRODUCER, SPORTHALLE LIEFERING

Energy consumption for heating

The total supplied heat in the measurement period March 2019 - February 2020 is about 131,200 kWh or 28.5 kWh/m²a and consists of the yields of the solar thermal system, the heat pump and the electric heating rod.

The measured specific heating energy consumption is about 24 kWh/m²_{GFAA}. After an HDD (heating degree days) adjustment, the specific energy consumption is 27.3 kWh/m²a. The calculated specific heating energy consumption of the energy performance certificate amounts to 47.6 kWh/m²a.

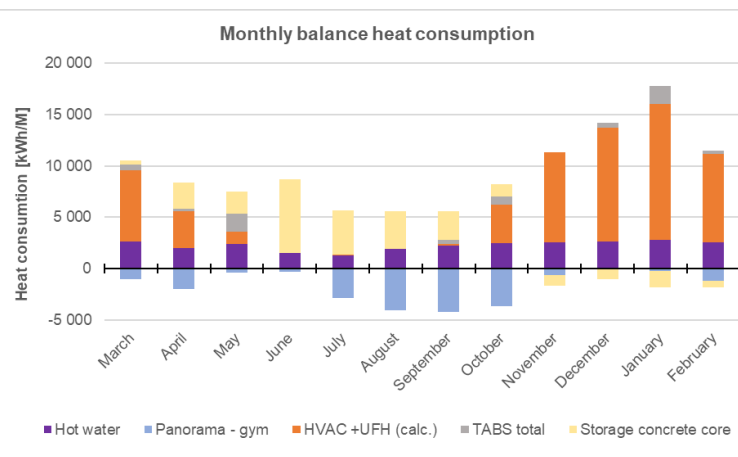

Fig.8 MONTHLY CONSUMPTION HEAT, SPORTHALLE LIEFERING

Allocation consumption

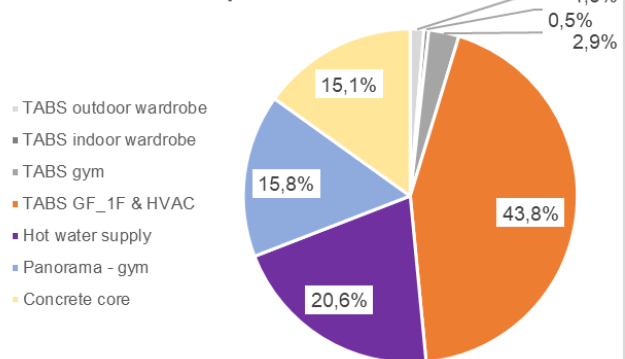

Fig.9 CONSUMPTION BREAKDOWN, SPORTHALLE LIEFERING

Energy consumption for cooling

The total cooling consumption in the measurement period March 2019 - February 2020 is around 59,909 kWh or 13 kWh/m²a, the calculated cooling energy consumption of the energy performance certificate is 12.1 kWh/m²a. Figure 10 shows the monthly cooling demand structure. The heat meters are not allocated to individual control loops; therefore, the measurements count the total amount of energy consumption for cooling and are not divided in ventilation and TABS. As expected, there are only count values in the months from May to September. The highest cooling demand is in July.

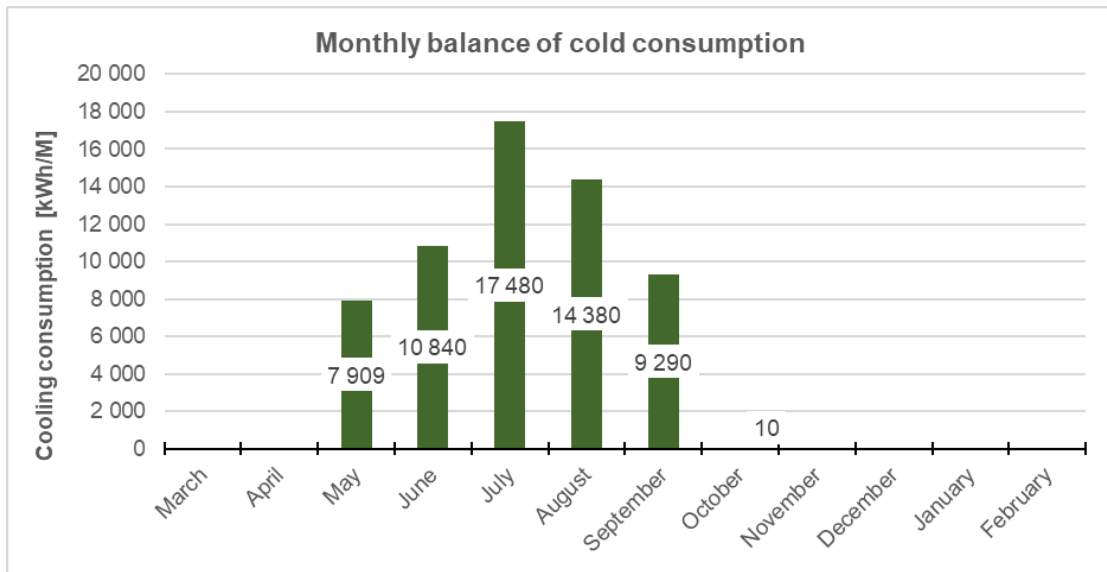

Fig.10 MONTHLY CONSUMPTION COLD, SPORHALLE LIEFERING

Power consumption and benchmarks

The power consumption in the measurement period March 2019 – February 2020 is about 176,200 kWh or 39 kWh/m²a. The specific maximum current power amounts to 21.1 kWh/m²a, the specific electricity base load is 2.1 kWh/m²a.

With 16.6 kWh/m²a or 43% of the total power consumption, the building services are the largest consumer. The largest consumer of the building services is the auxiliary energy (sum of the electricity meters ISP01, ISP02 and ISP03) with a consumption of 14 kWh/m² (a share of 37%). The share of Ancillary facilities is 15%, a list of these consumers is not known. 22% of the consumption is not counted.

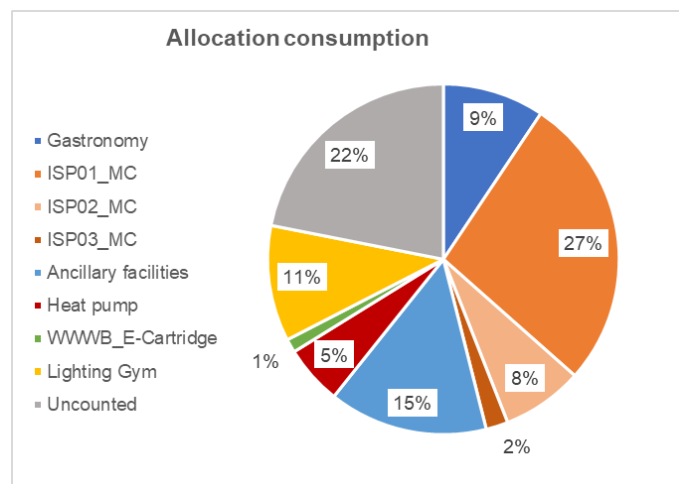

Fig.11 MONTHLY POWER CONSUMPTION, SPORHALLE LIEFERING

The photovoltaic system on the flat roof of the building has a nominal output of 110 kWp. Azimuth is 60° and -120°, the inclination 10°. The PV's own consumption is 50%. Considering the direct consumption of the adjoined building yard, the total amount of electric energy fed into the public grid is 20%. The total amount of electricity supplied is 176,000 kWh, and the total yield of the photovoltaic system is 88,345 kWh. The building's services equipment is the largest consumer, accounting for 43%.

Table.5 CO₂-CONCENTRATION AND ROOM TEMPERATURE

Measurement period: 01 September 2019 - 31 August 2020				
Reference room	Gym_1	Gym_2	Office_3	
Average room temperature in the heating period (temperature outside<12°C)	22.99	20.97	20.42	°C
Average room temperature in the summer months (temperature outside>12°C)	23.47	23.18	22.47	°C
Share of overheating hours (T > 26°C) in the total number of annual hours	0	0	0	%
Share of CO ₂ concentration (CO ₂ >1000ppm) in the total number of annual hours	-	1	0	%

5.2 Comfort

Four rooms (two zones of the gym and office rooms 2 and 3) were selected as reference rooms for comfort and CO₂ monitoring. The measured parameters are temperature and CO₂ content. Some of the temperature sensors are pre-existing. Due to faulty signals of the measurements in office 2, only 3 reference rooms are evaluated. Table 5 gives an overview of the measurements.

CO₂ monitoring

The CO₂ concentration in parts per million at the two measuring points in the gym is shown in Figure 12. The green area marks the range between the first and third quartiles, and the lines mark the range between the minimum and maximum values.

It can be seen from the plot that most of the values are in the range of the outdoor air concentration.

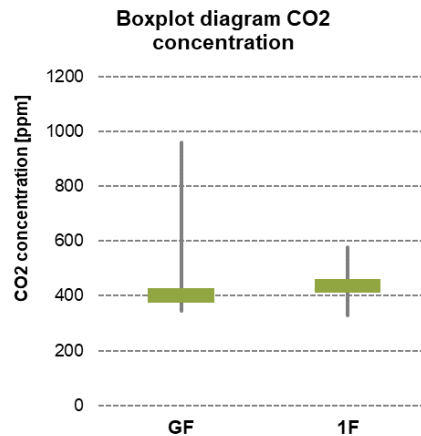

Fig.12 CO₂ CONCENTRATION, SPORTHALLE LIEFERING

Temperature

As can be seen in Figure 13, the temperature in the office is between 22 and 23 °C during the heating season and the measured temperatures are mainly in the comfortable range. In the summer, temperatures of up to 28 °C occur sporadically. In the gym, a correlation between outdoor and indoor air temperature is visible over the whole year. Nevertheless, most of the temperatures measured are in the comfortable range. The highest temperatures of 26 °C in the gym only occur for a few hours. The measurements show that the conditioning works very well.

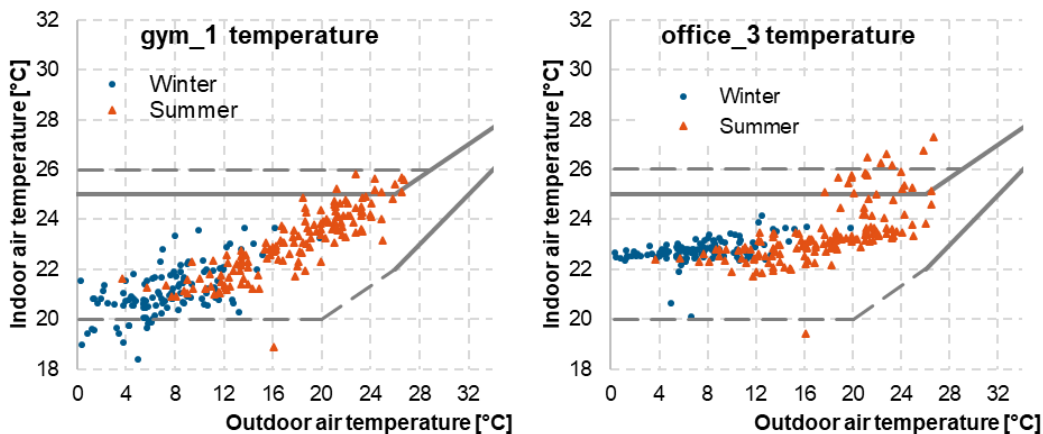

Fig.13 COMFORT PARAMETERS ROOM TEMPERATURE AND RELATIVE HUMIDITY, SPORTHALLE LIEFERING

Lessons Learned

6. Discussion, Lessons Learned

6.1 Summary

Resilient, flexible and effective cooling method

Cooling through window ventilation and a Thermal Activation Building System (TABS) is an effective cooling method. The TABs, which provide additional cooling when needed, are installed in the base of the building. This base is also required for flood protection, resulting in a climate resilient project. The system is flexible as the TABs can provide additional cooling when cooling by window ventilation is insufficient.

6.2 Optimisation potential

Installations assigned to the electricity meters ISP01 - ISP03 are unknown

- ISP01 (50 MWh) has a constant daily consumption of 140-170 kWh in summer (minimum 5 kW at night, maximum 7 kW during the day). The daily consumption in winter amounts is 75-200 kWh. It is assumed that auxiliary energy for heating and cooling is included. Saving potentials in the base load would be particularly efficient, as they are effective throughout the whole year. Typical saving potentials would be in circulation pumps and stand-by appliances.
- ISP02 (13.2 MWh) has a constant continuous energy consumption of about 37 kWh per day.
- ISP03 (3.6 MWh) has an irregular time profile with a maximum consumption of 4 kW. Due to the lack of seasonal correlation, it is assumed that the electricity meter measures the demand for hot water supply.

Low heat consumption of TABS

- The heat meter of the main distribution board shows a seasonal profile according to the weather pattern. There is no heat output at night. The sub-counter records a low demand of TABS. Energy consumption for the TABS in the indoor changing room and the gym is only recorded on a few days.

Optimising energy demand for hot water

- The energy demand for the hot water supply remains at a constant level during the holidays. Evaluating and adjusting the hot water demand to the actual hot water demand during the holidays could lead to additional savings.

Optimizing energy demand for lighting

- The evaluation of the consumption data from March 2020 to April 2020 shows that the energy demand did not decrease significantly during the COVID-19 restrictions. Therefore, there is potential for savings in hot water and lighting.

References & Key Contacts

7. References & Key Contacts

7.1 References

ASHRAE, ANSI/ASHRAE Standard 169-2013, Climatic Data for Building Design. Atlanta: ASHRAE, 2013.

Lampersberger, P. (2021). “Demo light Impact-Monitoring und messtechnische Untersuchung von energieeffizienten Gebäuden”

P. Holzer. (2020). “Annex 80 - Resilient Cooling of Buildings Task Group Key Performance Indicators”

OIB-Richtlinie-6. (2019). Austrian Institute of Construction Engineers

7.2 Contacts

Company	Role	Contact
e7 energy innovation & engineering	Consultant	Paul Lampersberger paul.lampersberger@e-sieben.at +43 1 907 80 26 - 68

Introduction & Climate

1. Introduction

1.1 Introduction

The detached house was built in 2016. It is a single-family dwelling situated in Mol, Belgium. It was built according to the EPB-standard (Energy Performance of Buildings). The ground floor consists of a living room, kitchen, office and laundry room. The night zone is on the first floor, under the flat roof, and consists of 3 bedrooms, a hobby room and a bathroom.



Fig.1 EXTERIOR VIEW (W)

1.2 Local Climate

Location: Mol, Belgium. The single family house is located in a rural area. Coordinates: 51.1833° N, 5.1166° E

Climate Zone: The building is located in Climate Zone 4A Mixed Humid (ASHRAE). According to the Köppen climate system, Belgium has a moderate maritime climate (type Cfb) with relatively mild winters, mild summers and precipitation throughout the year.

Table.1 KEY INFORMATION ABOUT THE BUILDING

Location	Mol, Belgium
Building Type	Single Family House
Retrofit (Y/N)	N
Surroundings (Urban/Rural)	Rural
Year of Completion	2016
Floor Area (m²)	264
Building Volume (m³)	733
Shape factor (m)	0.75
Openable Area to Floor Area Ratio (%)	18%
Window to Wall Ratio (%)	22%
Climate Zone	Mixed Humid (4A)
No. of Days with Te max > 26	16 days
Cooling Season Humidity	43-74%

The dwelling unit was monitored during the summer of 2019. Two heat waves occurred during that period :

- 23/06-30/06/2019, max daily average 28,4°C,
- 22/07-26/07/2019, max daily average 33,8°C

Climate Zone	Description
0A	Extremely Hot Humid
0B	Extremely Hot Dry
1A	Very Hot Humid
1B	Very Hot Dry
2A	Hot Humid
2B	Hot Dry
3A	Warm Humid
3B	Warm Dry
3C	Warm Marine
4A	Mixed Humid
4B	Mixed Dry
4C	Mixed Marine
5A	Cool Humid
5B	Cool Dry
5C	Cool Marine
6A	Cold Humid
6B	Cold Dry
7	Very Cold
8	Subarctic

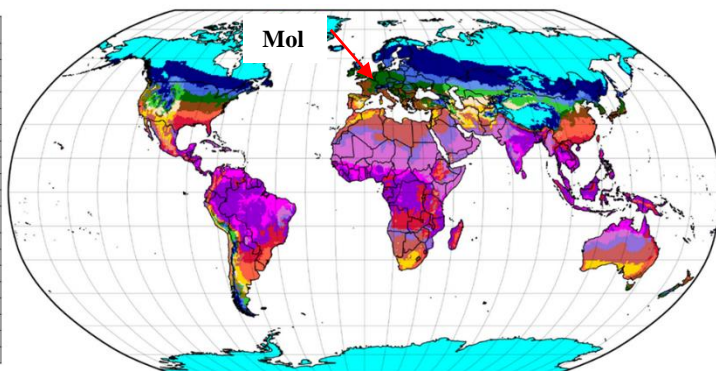

Fig.2 CLIMATE MAP (ASHRAE 169 - CLIMATE DATA FOR BUILDING DESIGN STANDARDS)

2. Building Information

2.1 Description

The building is a residential property built in 2016, with

- solid construction with flat roof
- W orientation of the façade
- automatic solar shading on W and S windows

Table.2 BUILDING PROPERTIES

Property	Unit	Value
Window U-value	W/(m ² K)	0.6
Window g-value	-	0.65
Average Wall U-value	W/(m ² K)	0.31
Glass to Floor Ratio	%	12%
Air-tightness (@50 Pa)	1/h	0.83

Table.3 INFORMATION PLANNING, OPERATION AND USE

Information on planning, operation and use	
Object use	Residential use
Integral planning process	Architectenbureau Sels BVB

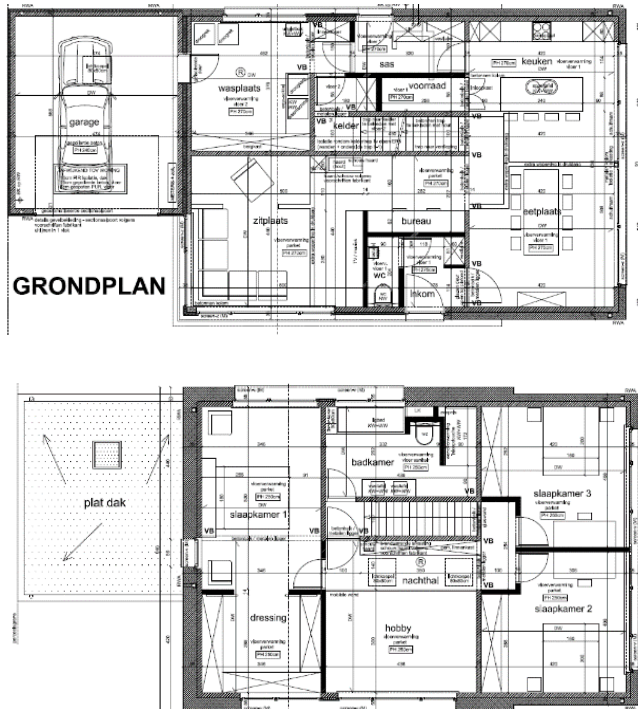

Fig.3 FLOOR PLANS

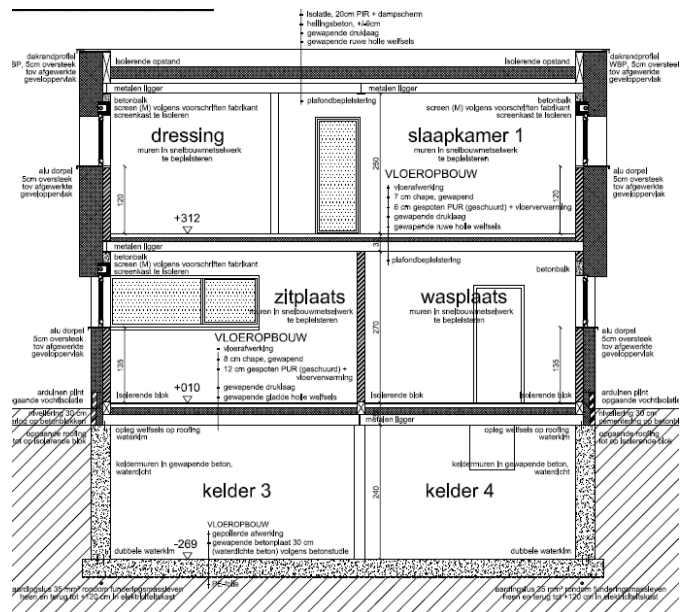

Fig.4 SECTION PLAN

Energy System

2. Building Information

2.2 Energy Systems

Heating System

The building is heated by a geothermal heat pump with a thermal power of 6kW. The heat pump is coupled to a borehole with a borehole depth of 120m. There is floor heating/cooling on all floors. The geothermal heat pump is also used for domestic hot water.

Cooling System

The installation allows free geothermal cooling in summer, bypassing the heat pump. (Indirect) evaporative cooling has been added in the return of the ventilation unit.

Electrical Power Supply

Electricity consumption is supplied by the public grid. The electricity demand is made up of the household electricity demand and the heat pump.

Hygienic ventilation.

The dwelling unit has a ventilation system with heat recovery and summer bypass. The ventilation system includes supply and exhaust fans that supply and exhaust an equal amount of air.

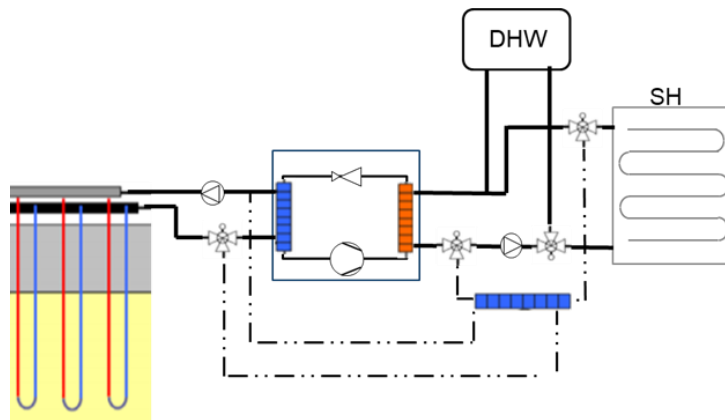

Fig.5 PRINCIPLE SCHEME OF A GEOTHERMAL HEAT PUMP WITH FREE COOLING

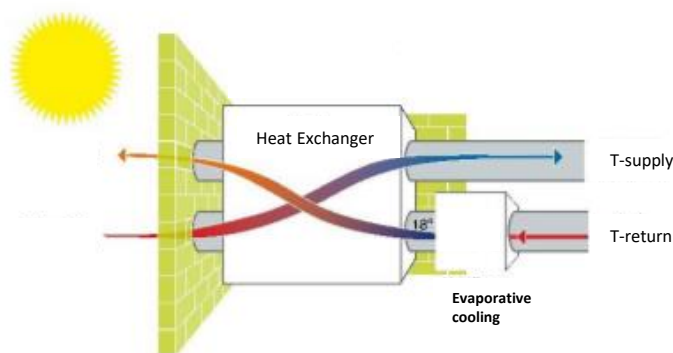

Fig.6 INDIRECT EVAPORATIVE COOLING

3. Resilient Cooling

3.1 Principles

A free geothermal cooling system is used. Water of about 16°C is pumped up from the boreholes. It passes through a heat exchanger where it cools down the return water from the floor cooling. The only energy consumption is the auxiliary energy from the pumps.

Beside that, the heat exchanger of the ventilation unit has a by-pass allowing some free cooling when the outdoor temperature is lower than the indoor temperature.

Evaporative cooling is added in the return of the ventilation unit: water is evaporated to cool down the extracted air. In this way, the supply air is cooled indirectly (through the heat exchanger).

3.2 Control strategy

The free geothermal cooling has an on/off control based on the outside temperature.

When both the outdoor and indoor temperatures are higher than the set desired room temperature, the cooling starts.

To avoid condensation on the floors, a dew point control is added. Sensors in the dwelling detect the dew point of the indoor air. If the detected dew point temperature is higher than the supply temperature of the floor cooling, the heat exchanger with the borehole-loop is bypassed.

Table.4 STRUCTURE OF THE SYSTEM

<i>1. Reducing Heat Loads to People and Indoor Environments</i>	
1.1. Solar Shading Technologies	
1.2. Cool Envelope Materials	
1.3. Glazing Technologies	
1.4. Ventilated Façades	
1.5. Green Roofs and Green Façades	
<i>2. Reducing Heat Loads to People and Indoor Environments (Production, Emission and combined)</i>	
2.1. Ventilative cooling	
2.2. Thermal Mass Utilization	
2.3. Evaporative Cooling	
2.4. Sky Radiative Cooling	
2.5. Compression Refrigeration	
2.6. Adsorption Chiller	
2.7. Natural Heat Sinks	
2.8. Radiant Cooling	
<i>3. Increasing Personal Comfort Apart from Space Cooling</i>	
3.1. Comfort Ventilation and Elevated Air Movement	
3.2. Micro-cooling and Personal Comfort Control	
<i>4. Removing Latent Heat from Indoor Environments</i>	
4.1. Dehumidification	

KPI Evaluation

4. KPI Evaluation

Due to the limited data available, the KPI values presented in this chapter only cover the period from 15 June 2019 to 8 August 2019. However, as the measuring period includes both heatwaves that took place in 2019, it is believed that the following KPIs are a good representation of the performance of the resilient cooling technology under extreme weather conditions.

4.1 Thermal Comfort KPIs

Hours of exceedance (HE) **168.84 h/a**
Hours outside the range of 26°C

4.2 Energy

Annual cooling site energy use intensity **4.32 kWh/m²a**
Annual cooling site energy use intensity

4.3 Carbon dioxide (CO₂) emissions

Annual amount of CO₂ emissions **855.36 gCO₂/m².a**

The annual electricity use for space cooling is 1141 kWh/a (i.e. 4.32 kWh/(m².a) for 264 m² conditioned floor area), and the carbon dioxide (CO₂) emissions factor for electricity is 198 gCO₂/kWh.
(<https://www.nowtricity.com/country/belgium/>)

Performance Evaluation

5. Performance Evaluation

5.1 Comfort monitoring

Temperature was monitored in the bedrooms and living room. Initially it was evaluated against the comfort criteria of EN15251/EN16798, with cat. I being the highest comfort category.

Even when the geothermal cooling was interrupted for 2 weeks, the temperature exceeding hours in both living and sleeping rooms were acceptable.

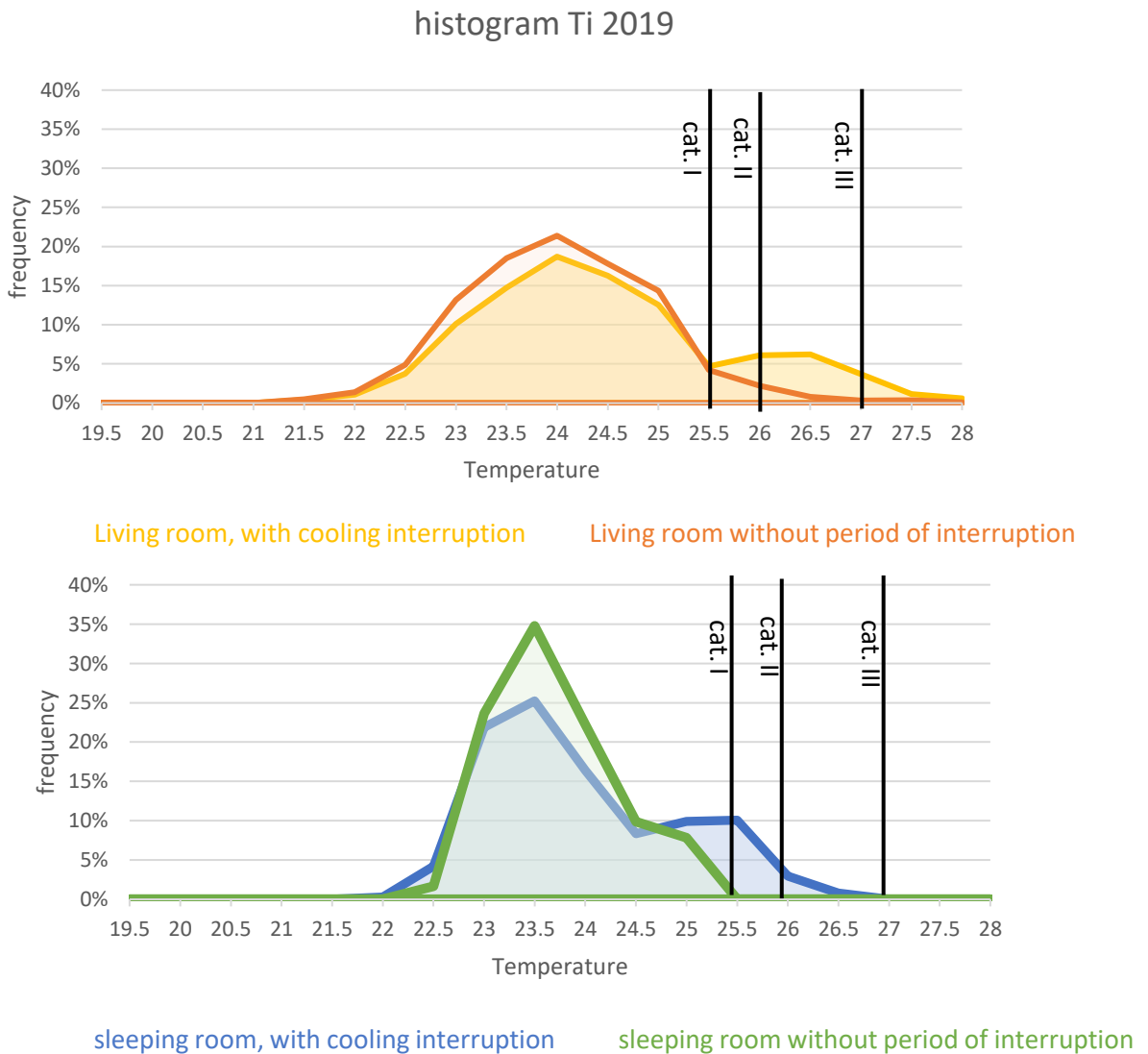

Fig. 7 HISTOGRAM OF MEASURED TEMP, COMFORT CATEGORIES (cat I, II and II) ACCORDING TO EN15251/EN16798

Performance Evaluation

For ‘alpha-buildings’, adaptive temperature limits, where the temperature limit is a function of the running mean outdoor temperature, are more appropriate. An ‘alpha-building’ indicates a building with a major occupant influence on the indoor environment. An important criteria is for instance the operability of the windows. In this type of buildings less stringent comfort criteria should be used since occupants have other expectations compared to occupants in centrally controlled buildings. Fig 8 compares the measured temperatures with the adaptive limits according to A.C. van der Linden et al.

Especially during the heat waves, much higher temperatures are allowed. As can be seen from Fig. 8, the measured temperatures easily meet these adaptive criteria. The tree lines refer to comfort classes A, B and C, with respectively an acceptability of 90%, 80% and 65%.

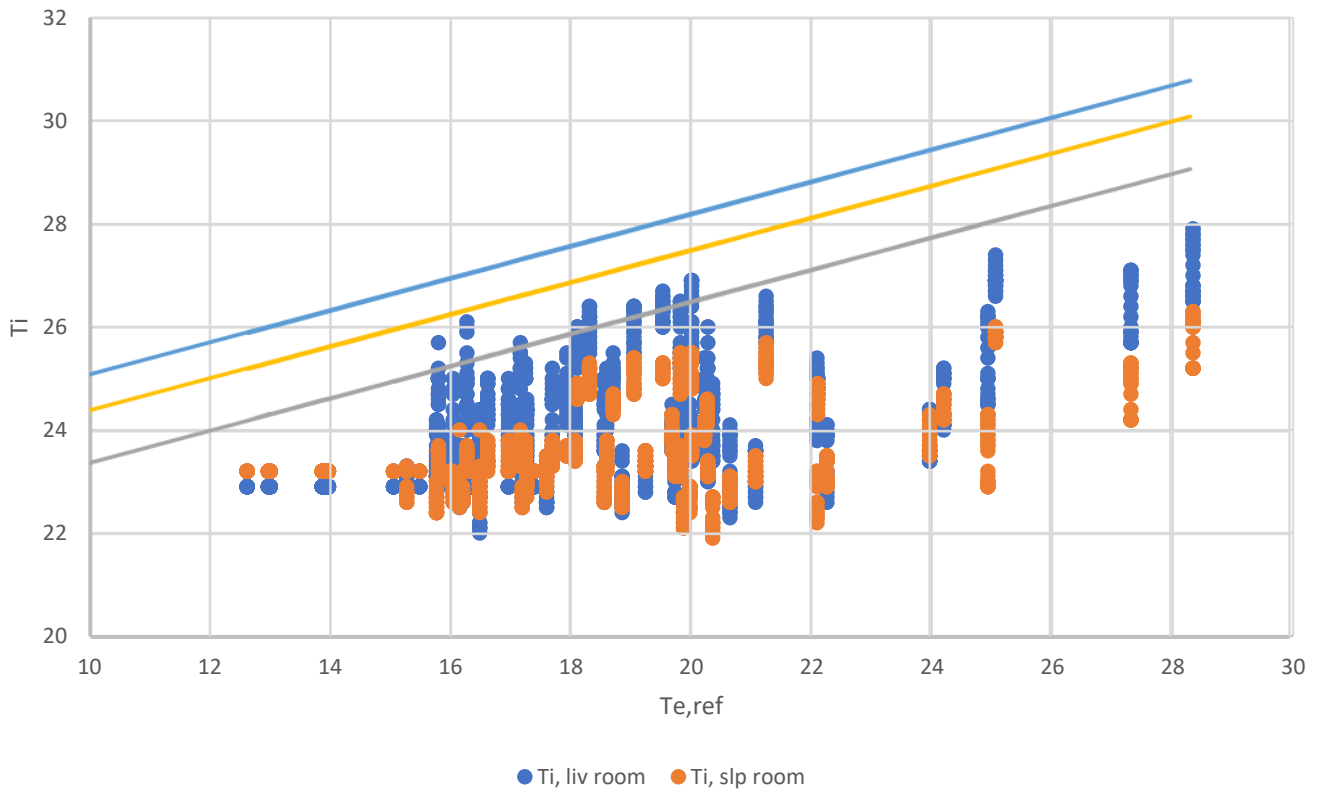

Fig. 8 TEMP MEASUREMENTS AND ADAPTIVE TEMPERATURE LIMITS (A.C. VAN DER LINDEN ET AL.)

Performance Evaluation

5.2 Interruption of free cooling and automatic screens.

The highest temperatures were monitored during the heat wave at the end of July 2019 (22/07-26/07/2019). During this period, the occupants were on holiday. The automatic screens were turned off 3 days before the start of the heat wave, and at the beginning of the heat wave, the free geothermal cooling was turned off. The measurements in Fig. 9 show an increasing indoor temperature during this period, but based on Fig. 7 and 8, the temperature at the end of the heat wave was still acceptable.

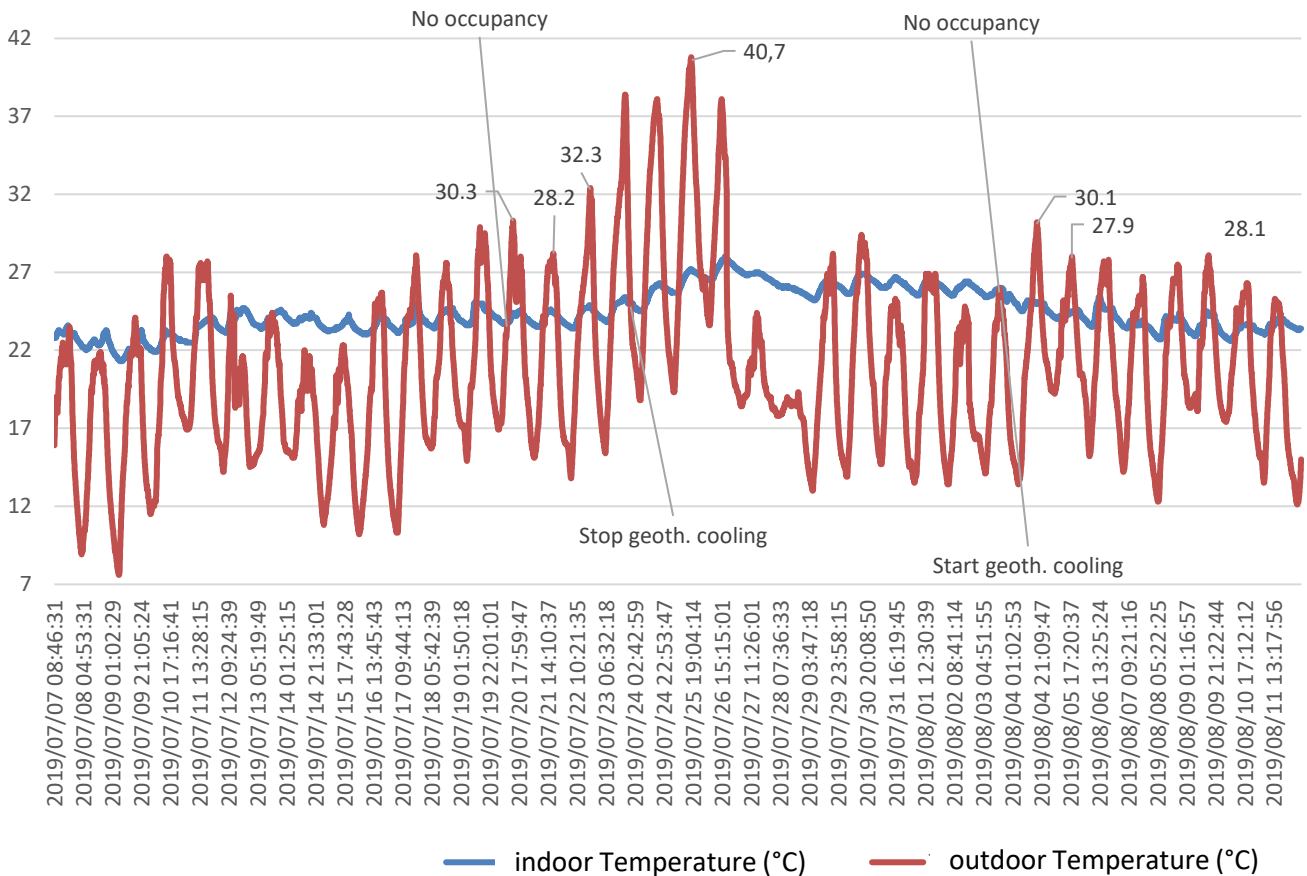

Fig. 9 TEMP MEASUREMENTS

5.3 Energy use

Energy consumption for cooling

The total cooling consumption in the measurement period from 15 June 2019 to 8 August 2019 is 1,141 kWh, which is low for a period of nearly 2 months if compared to active cooling. The complete data for the entire cooling season is not available. However, the measurement period includes the two heat waves (extreme weather conditions) that occurred that summer.

6. Discussion, Lessons Learned

6.1 Summary

In general, it was found that it was possible to achieve acceptable summer comfort in this residential case, using low energy cooling, such as free geothermal cooling. In this case, it was combined with evaporative cooling, but the cooling power of the latter was very low compared to the cooling power of the floor cooling. Even during two major heat waves, the indoor temperature in the living room and in the bedrooms was acceptable.

6.2 Optimisation potential

The current free cooling system is controlled by an on/off control signal based on a combination of outdoor temperature and indoor dew point temperature.

However, comfort could be improved:

- if a proportional dew point control is used for the supply temperature of the floor cooling,
- if the free cooling is turned on as a function of the indoor temperature (which can increase due to solar gains, even if the outdoor temperature remains low).

The cooling potential of the evaporative cooling was low, partly due to the low airflow rate of the residential building. The cooling power of the evaporative cooling could be improved by increasing the airflow rate. The airflow rate can potentially be rebalanced and set higher than the hygienic ventilation requirements.

Finally, the control signal of the bypass on the ventilation system and the control signal of the evaporative cooling did not appear to be well matched.

References & Key Contacts

7. References & Key Contacts

7.1 References

ASHRAE, ANSI/ASHRAE Standard 169-2013, Climatic Data for Building Design. Atlanta: ASHRAE, 2013.

<https://www.nowtricity.com/country/belgium/>

<https://www.anneliessels.be/>

A.C van de Linden. 2006. Adaptive temperature limits: A new guideline in the Netherlands.

7.2 Contacts

Company	Department	Contact
Thomas More University	<u>Expertisecentrum Energie</u>	Simon Binnemans Nickey Van den Bulck Griet Janssen Info.kce.kempen@thomasmore.be

Introduction & Climate

1. Introduction & Climate

1.1 Introduction

The reference office building is a nearly Zero-Energy Building and has three floors and a parking space in the basement and is shown in Fig.1. The building is equipped with fixed horizontal slats for solar shading. The building is built with a heavy concrete structure that creates high thermal inertia. A maximum of 357 people can be accommodated in the building.

The heating, ventilation, and air conditioning (HVAC) strategy used in this study is an air-cooled chiller (electric) with water cooling coils. The outdoor air supplied to the building through the mechanical ventilation unit is preheated/cooled before it is supplied to the building zones, where it is heated/cooled again.

The reference building is a passive house-certified building through dynamic simulations. The building is designed with high thermal insulation, airtightness, optimized construction nodes, and dual-flow ventilation with heat recovery. In addition, passive strategies against overheating like fixed solar shading using horizontal louvres, free cooling through night ventilation are also adopted to improve cooling energy efficiency in the building design.



Fig.1 EXTERIOR VIEW, CLINIC SAINT-PIERRE, BRUSSELS, BELGIUM.

Table.1 KEY INFORMATION ABOUT BUILDING

Location	Brussels, Belgium
Building Type	Office Building
Retrofit (Y/N)	N
Surroundings (Urban/Rural)	Rural
Year of Completion	2017
Floor Area (m²)	4,230
Building Volume (m³)	10,115
Window to Wall Ratio (%)	38.25
Climate Zone	Mixed Humid (4A)
No. of Days with Te max > 25	56

1.2 Local Climate

Location: Brussels, Belgium, at coordinates of 50°40'04.67" N and 04°33'39.68" E, and at an elevation of 112 m.

Climate zone: The case study building is in the Mixed Humid (4A) zone.

Climate Zone	Description
0A	Extremely Hot Humid
0B	Extremely Hot Dry
1A	Very Hot Humid
1B	Very Hot Dry
2A	Hot Humid
2B	Hot Dry
3A	Warm Humid
3B	Warm Dry
3C	Warm Marine
4A	Mixed Humid
4B	Mixed Dry
4C	Mixed Marine
5A	Cool Humid
5B	Cool Dry
5C	Cool Marine
6A	Cold Humid
6B	Cold Dry
7	Very Cold
8	Subarctic

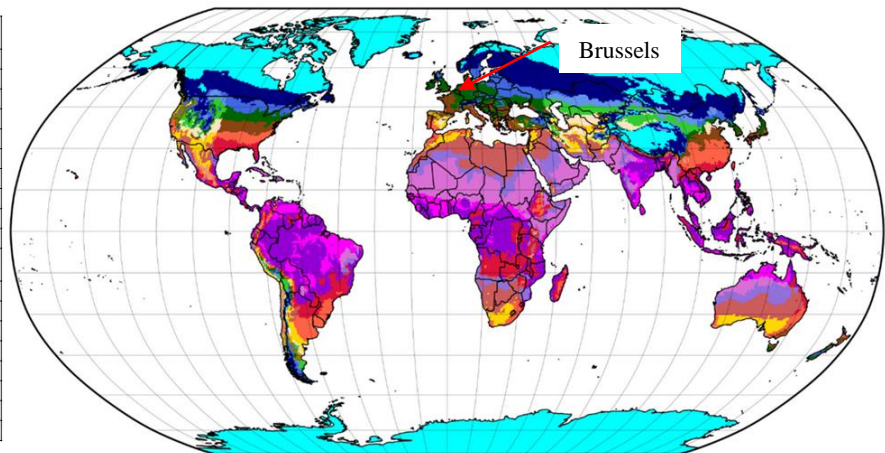

Fig.2 CLIMATE MAP (ASHRAE 169 - CLIMATE DATA FOR BUILDING DESIGN STANDARDS)

Building Information

2. Building

2.1 Envelope and Construction

The building is a commercial building used as an office space. It was opened in 2017.

Features of the building envelope and construction

- Construction of a passive office building for the Clinic Saint-Pierre.
- A passive construction of 3,090 m² of offices, meeting rooms, multipurpose spaces and 1,140 m² of basement car parking.
- Project certified by passive house platform via PHPP and dynamic simulations.
- High thermal insulation, airtightness, optimized construction nodes, etc.
- Double-flow ventilation which capture fresh air and then passes it through a heat exchanger.
- Gas condensing boiler for heating and high efficiency chiller for cooling.
- Passive measures against overheating by free cooling through night ventilation.

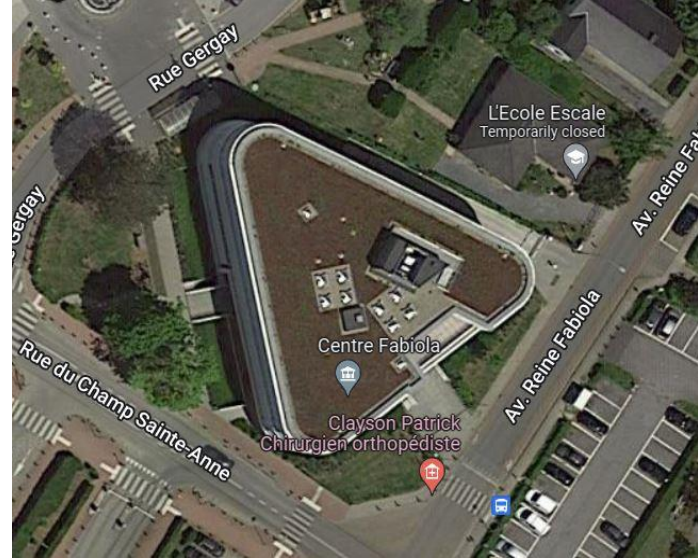

Fig.3 AERIAL VIEW WITH SURROUNDINGS OF CLINIC SAINT-PIERRE, BRUSSELS, BELGIUM. © GOOGLE MAPS

The composition of the reference building is as follows:

- The external walls consist of three layers. Cast concrete, MW glass wool roll, and plasterboard are used from the outer layer to the inner layer.
- The ground floor consists of four layers. Urea formaldehyde foam, cast concrete, floor screed, and timber flooring are used from the outer layer to the inner layer.
- The internal floors consist of a layer of an aerated concrete slab.
- The external roof consists of four layers. Asphalt, MW glass wool roll, air gap, and plasterboard are used from the outer layer to the inner layer.
- Triple-glazed, clear, low emissivity, argon filled external windows, and double pane, clear, air-filled internal windows.

Table.2 BUILDING U-VALUES

Envelope	U-value
Window U-value (W/m ² K)	0.50
Window g-value (-)	0.50
Wall U-value (W/m ² K)	0.35
Floor U-value (W/m ² K)	0.25
Roof U-value (W/m ² K)	0.25

Table.3 INFORMATION PLANNING, OPERATION AND USE

Information on planning, operation and use

Object use	Commercial building used as an office space.
Integral planning process	Clinic Saint-Pierre, as the owner, actively managed the planning process.
Technical management	Own operational management with the support of external maintenance companies
Energy monitoring	Energy Management System maintained by Equans, Belgium.

Energy System

2.2 Energy Systems

Different systems are used for the energy supply. Electricity for cooling is supplied by the public grid. The building is heated by using natural gas. This applies to both space heating and hot water. The HVAC system consists of an air-cooled chiller (electric) with water cooling coils and a water boiler (natural gas) with water heating coils. Ventilation units are used for both thermal treatment and hygienic airflow. The HVAC system is shown in Fig.4.

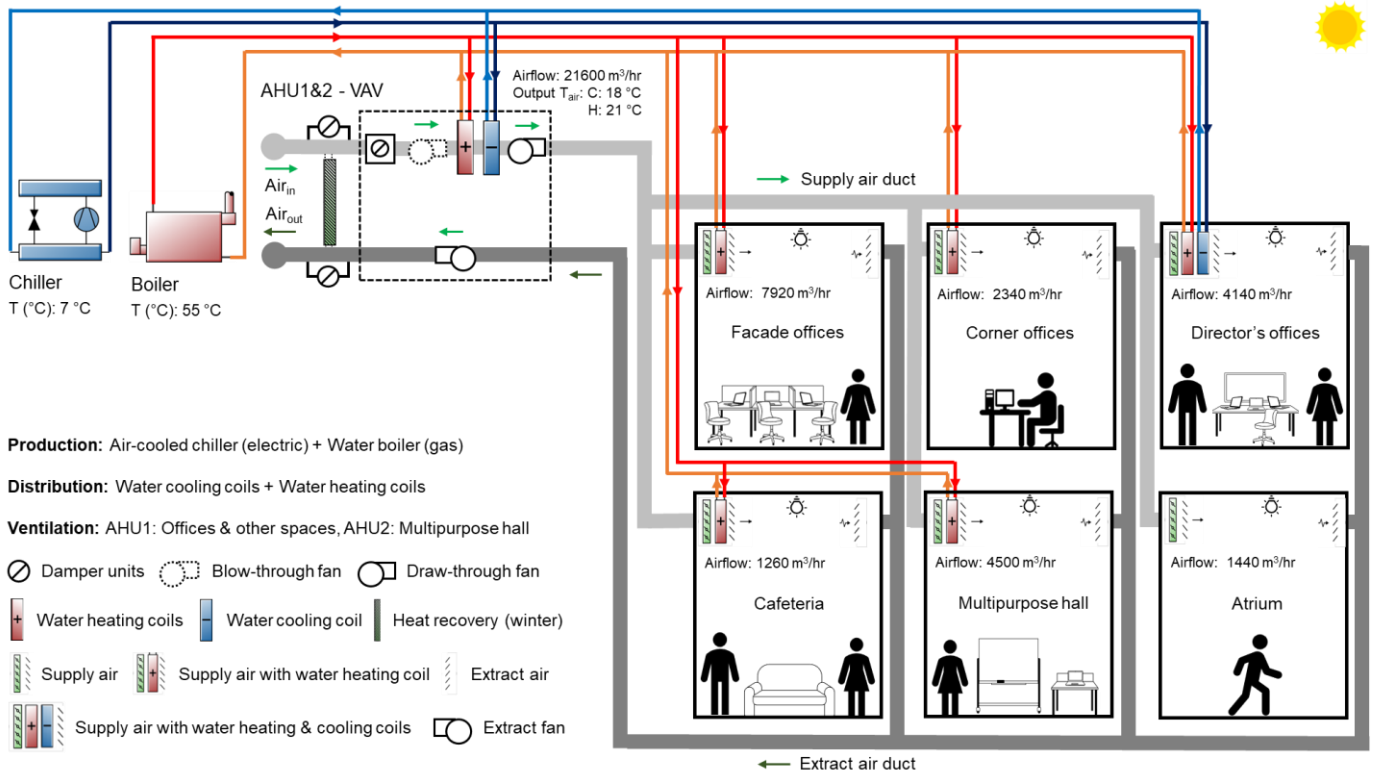

Fig.4 SCHEMATIC DIAGRAM OF THE HVAC SYSTEM USED AT THE CLINIC SAINT-PIERRE, BUILDING TECHNOLOGY AND MEASUREMENT CONCEPT.

Heating System

The heating system used in this building is a water boiler (gas) with water heating coils. The heating system operates by heating water using the gas boiler and then circulating it through the building.

Cooling System

The cooling system used in this building is an air-cooled chiller (electric) with water cooling coils. The cooling system uses an air stream to transfer heat from the processed water using an evaporator in the chiller.

Electrical Power Supply

Electricity consumption is covered by the public grid. The electricity demand is made up of the electricity demand for the building services like space cooling, lighting, office equipment, etc.

Resilient Cooling

3. Resilient Cooling

3.1 Principles

In principle, the rooms are cooled by introducing conditioned supply air. There is a water-cooling coil in the ventilation. The water-cooling coil is responsible for cooling down the air in the supply air. Additionally, there are extra cooling coils at the director’s offices as shown in Fig.4. In design, passive measures against overheating by free cooling through night ventilation strategies can be adopted to improve the cooling energy efficiency. However, the analysis of building performance data indicate that the active cooling system was function 24/7 during real building operation. The project uses a high-performance compression chiller, see Fig.5. The comfort measurement locations were situated on Floor +1 of the reference building and are shown in Fig.6. The other passive measure used in the building is solar shading using fixed horizontal louvres. The installed chiller unit is an R410a filled single-circuit chiller. Outdoor air-cooled chiller for commercial buildings or other industrial applications. It has scroll compressors with a high yield and low electricity absorption, axial fans to ensure the quietest machine operation possible, a plate heat exchanger, and a finned-pack copper/aluminum coil. An operation at full load up to an outdoor dry-bulb temperature of 46 C and up to -10 C of chilled water can be produced by the unit. The system is efficient, affordable and climate protective.

3.2 Components

Table.4 STRUCTURE OF THE SYSTEM

1. Reducing Heat Loads to People and Indoor Environments	
1.1. Solar Shading Technologies	
1.2. Cool Envelope Materials	
1.3. Glazing Technologies	
1.4. Ventilated Façades	
1.5. Green Roofs and Green Façades	
2. Reducing Heat Loads to People and Indoor Environments	
2.1. Ventilative cooling	
2.2. Thermal Mass Utilization	
2.3. Evaporative Cooling	
2.4. Sky Radiative Cooling	
2.5. Compression Refrigeration	
2.6. Adsorption Chiller	
2.7. Natural Heat Sinks	
2.8. Radiant Cooling	
3. Increasing Personal Comfort Apart from Space Cooling	
3.1. Comfort Ventilation and Elevated Air Movement	
3.2. Micro-cooling and Personal Comfort Control	
4. Removing Latent Heat from Indoor Environments	
4.1. Dehumidification	

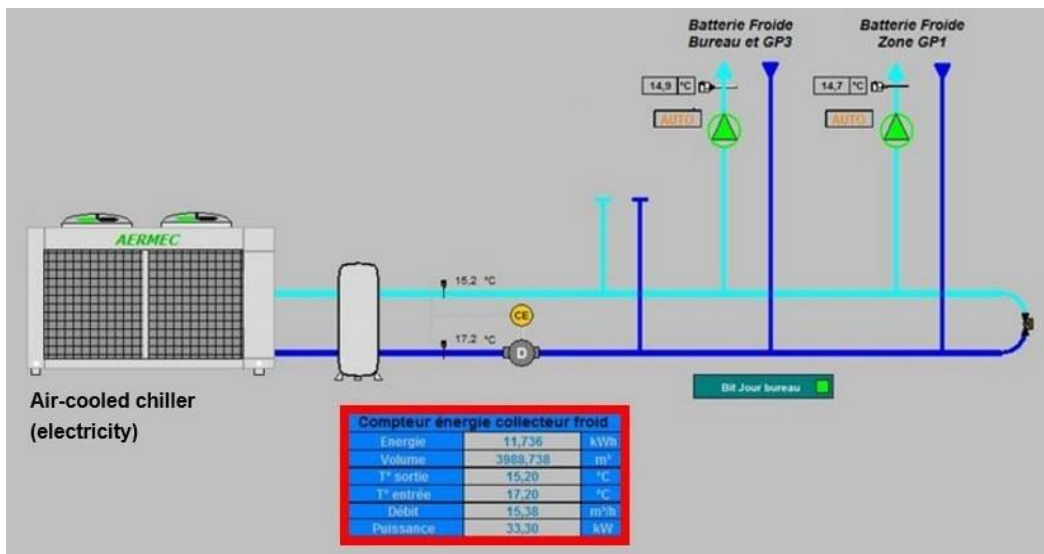

Fig.5 REFERENCE BUILDING COOLING SYSTEM AND ENERGY USE MEASUREMENTS.

Resilient Cooling

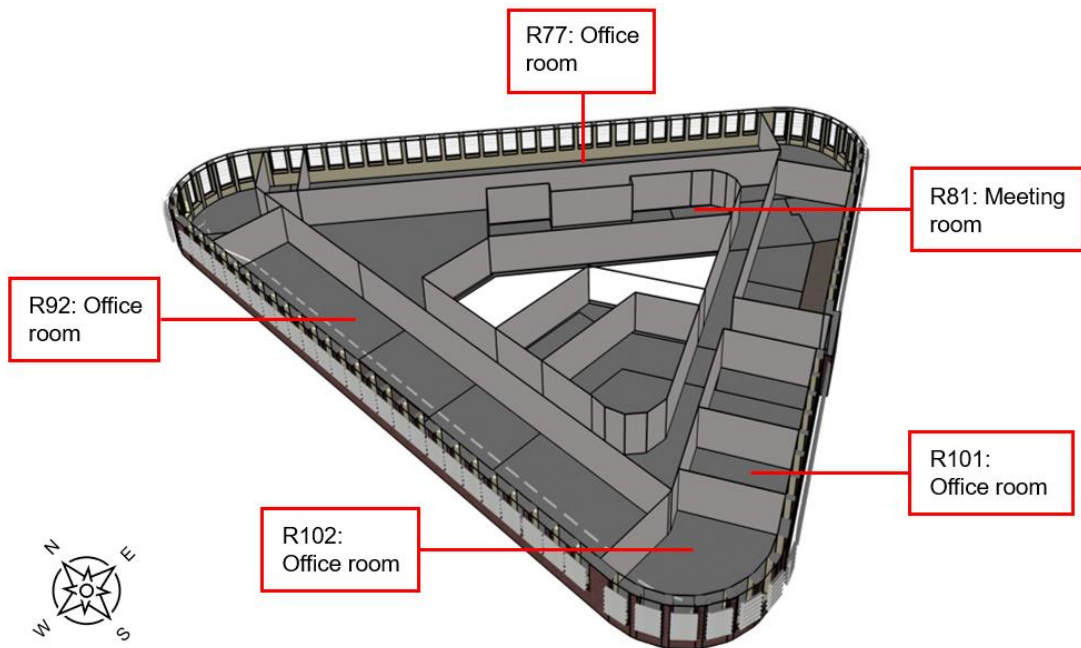

Fig.6 THERMAL COMFORT MEASUREMENT POINTS - CLINIC SAINT-PIERRE (FLOOR +1), BRUSSELS, BELGIUM.

KPI Evaluation

4. KPI Evaluation

4.1 Thermal Comfort KPIs

Hours of exceedance (HE) **35 h/a**
Hours outside the range of 26°C

Indoor Overheating Degree IOD **0.05 C**
Hourly summation of the positive values of the difference between the operative temperature of the occupied building thermal zones and the zonal thermal comfort limit temperature (26 C), divided by the sum of the zonal occupied hours.

Ambient Warmness Degree AWD **4.43 C**
Hourly summation over the summertime period of the positive values of the difference between the outdoor air temperature and a fixed base temperature (18 C), divided by the total number of building occupied hours.

Overheating Escalation Factor OEF **0.01**
An indicator of the resistivity of a building to climate change and associated overheating risk.

4.2 Energy

Annual cooling site energy use intensity **15.02 kWh/m²a**
Annual cooling site energy use intensity

SCOP **2.50**
Seasonal coefficient of performance

4.2 Carbon emissions

Annual amount of Carbon dioxide (CO₂) emissions caused by space cooling **4055 gCO₂/m².a**
Annual site electricity use for space cooling is 15.02 kWh/m²a, and the carbon dioxide (CO₂) emissions factor for electricity is 270 gCO₂/kWh [Encon].

5. Performance Evaluation

5.1 Cooling energy use

The building site cooling energy use of the reference nearly-zero energy office building was analyzed using monthly consumption data for electricity collected from May 2018 to April 2019. Fig.7 and Fig.8 show the monthly cooling demand pattern. It becomes clear that the demand for cooling for supply air conditioning occurs predominantly in the period from June to September, with highest demand in August. The monthly site cooling energy use per square meter is shown in Fig.7, and the monthly primary cooling energy use per square meter is shown in Fig.8. The annual site cooling energy use per square meter was 15.02 kWh/m².a and the annual primary cooling energy use per square meter was 37.54 kWh_{PE}/m².a for the reference building.

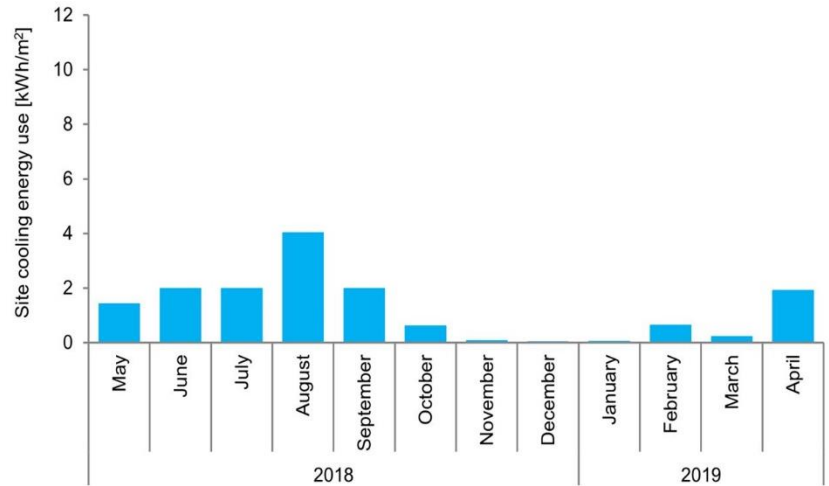

Fig.7 SITE COOLING ENERGY USE, CLINIC SAINT-PIERRE, BRUSSELS, BELGIUM

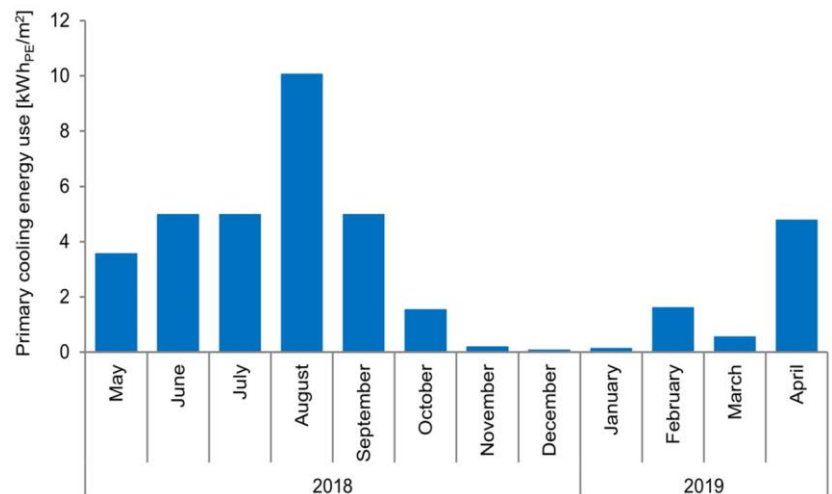

Fig.8 PRIMARY COOLING ENERGY USE, CLINIC SAINT-PIERRE, BRUSSELS, BELGIUM

Performance Evaluation

5. Performance Evaluation

5.2 Comfort monitoring

Hourly indoor ambient temperature values for measurement locations are plotted against hourly outdoor air temperature and EN 16798 PMV/PPD and adaptive comfort category II thresholds and is shown in Fig.9.

Time-integrated indoor overheating degree (IOD) of reference building, Clinic Saint-Pierre, is calculated using the measurements from May 2018 to April 2019. The IOD value of the building are listed in Table 5.

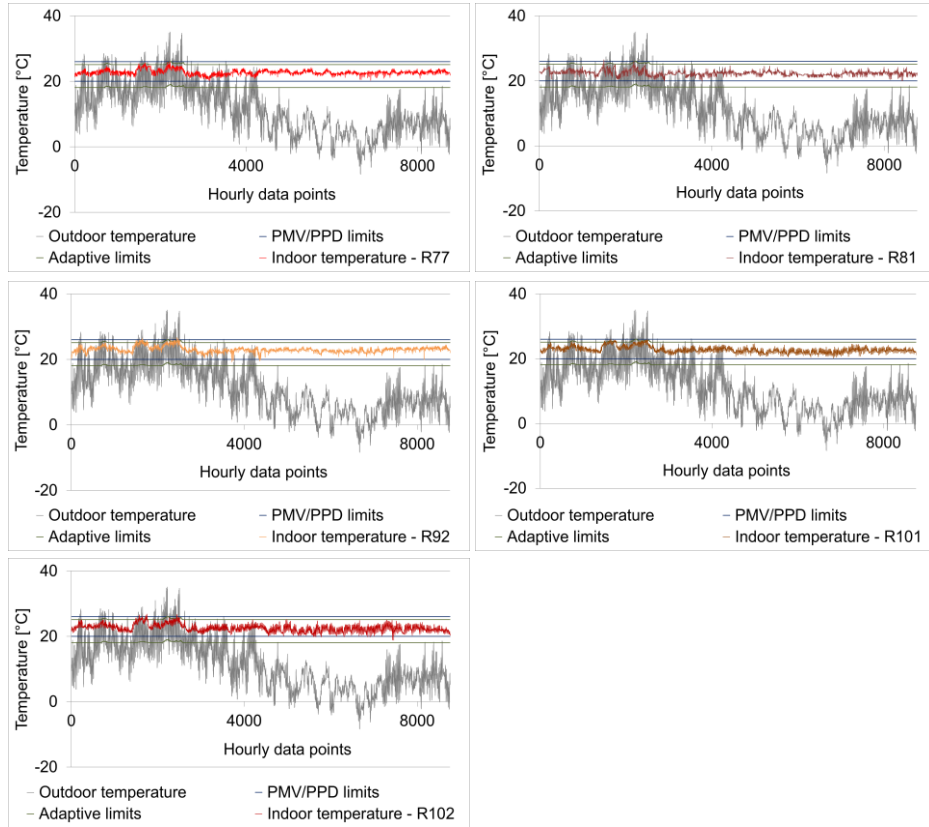

Fig.9 HOURLY INDOOR AMBIENT TEMPERATURE AT MEASUREMENT LOCATIONS.

Table.5 TIME-INTEGRATED THERMAL DISCOMFORT CALCULATIONS

Measurement period: 01 May 2017 - 30 April 2018

Indoor Overheating Degree (IOD)

0.05 C

5.3 CO₂ monitoring

Following the building energy use analysis, the total monthly GHG emissions from the cooling were calculated from May 2018 to April 2019 using Belgian conversion factors. In addition, the annual CO₂ emissions in kg per square meter of the building for cooling were calculated separately.

The monthly cooling GHG emissions per square meter from May 2018 to April 2019 are shown in Fig.10. The total annual cooling GHG emissions per square meter was 10.14 kgCO₂/m².a.

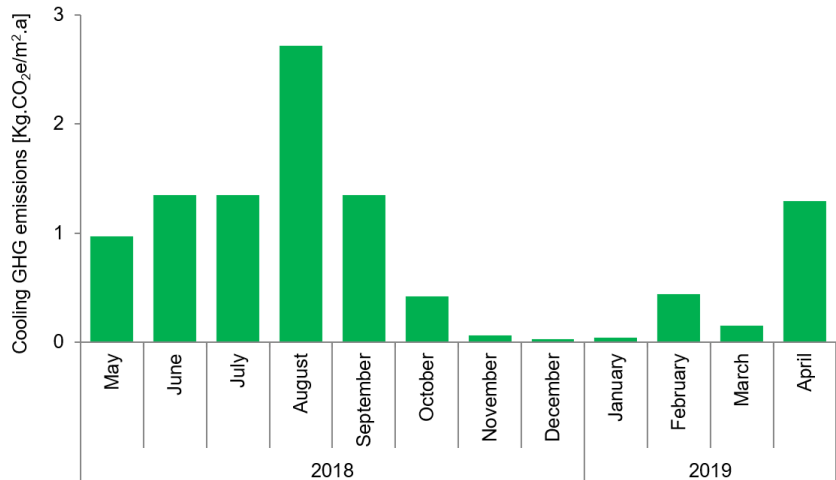

Fig.10 MONTHLY GHG EMISSIONS, CLINIC SAINT-PIERRE, BRUSSELS, BELGIUM.

6. Discussion, Lessons Learned

6.1 Summary

1. The HVAC system implemented in the building was an air-cooled chiller with water cooling coils. The system conditions the outdoor air through the mechanical ventilation unit, and this air cools the building.
2. The active cooling strategy with an air-cooled chiller (electric) with water cooling coils is constantly performing very well against the degree of overheating discomfort with an IOD value of 0.05 °C of overheating in the building during the monitored period.
3. The solar shading strategy using fixed horizontal louvres in the building is effective in reducing external solar gain.
4. Although the building was designed with free cooling through night ventilation strategy, it is not implemented during the real building operation. The active cooling system runs 24/7 and this results in an energy performance gap between designed and real energy use values.
5. The site and primary cooling energy use of the building was estimated at 15.02 kWh/m².a and 37.54 kWh_{PE}/m².a. To decrease the primary energy use for cooling purposes, the building should integrate renewable energy sources into the energy mix. These values indicate that building energy use is higher than expected.
6. The cooling GHG emissions from the building were estimated to be 10.14 kgCO₂/m².a.

6.2 Implication for future work and practice

Thermal comfort

Post-occupancy surveys and interviews are essential in determining how the users might influence the building's energy use. Researchers can compare the qualitative data collected through these interviews and surveys to understand how the occupants perceive buildings in terms of thermal comfort.

Quantitative monitoring and qualitative surveys

In addition to the quantitative data from the field monitoring, qualitative data from occupant surveys will enable a thorough evaluation of the building's performance. This will emphasize that the buildings must be efficient in terms of energy use and emissions, but they must also be efficient and useful in terms of thermal comfort.

HVAC systems

HVAC systems will always be an integral part of the building systems, even though well-designed building envelopes can significantly reduce cooling and heating loads. Efficient HVAC sizing can save energy use, while providing thermal comfort.

Effects of humidity

In addition, well-designed building envelopes and foundations can significantly reduce humidity infiltration. However, residual humidity transfer, in combination with the humidity produced by the occupants and building operations, will continue to make humidity removal a priority in building systems to ensure occupant health.

Mixed-mode building operation

A mixed mode building operation and HVAC operation based on building occupancy will reduce energy use and GHG emissions. These developments should consider the design, control, operation, and safety issues associated with the mixed-mode building operation. The need for the removal of latent heat in humid climates might prove a major barrier to mixed-mode building operations.

Multiyear observations

Future studies should also conduct a deeper analysis with multiyear observation to understand the building system patterns. Although there has been remarkable improvement in energy efficiency over the past few decades, there is still a significant amount of untapped potential, regarding theoretical limits and equipment performance.

7. References & Key Contacts

7.1 References

Climate Map:

ASHRAE, ANSI/ASHRAE Standard 169-2013, Climatic Data for Building Design. Atlanta: ASHRAE, 2013.

Research article:

1. D. Amaripadath, M. Velickovic, and S. Attia. "Performance evaluation of a nearly zero-energy office building in temperate oceanic climate based on field measurements." *Energies*, vol. 15, no. 18, p. 6755, 2022. doi: 10.3390/en15186755.
2. D. Amaripadath et al., "Climate change sensitive sizing and design for nearly zero-energy office building systems in Brussels," *Energy and Buildings*, vol. 286, p. 112971, Mar. 2023. doi: 10.1016/j.enbuild.2023.112971.
3. D. Amaripadath, R. Paolini, D. J. Sailor, and S. Attia, "Comparative assessment of night ventilation performance in a nearly zero-energy office building during heat waves in Brussels," *Journal of Building Engineering*, vol. 78, p. 107611, Nov. 2023, doi: 10.1016/j.job.2023.107611.

Data paper:

3. D. Amaripadath and S. Attia, "Performance dataset on a nearly zero-energy office building in temperate oceanic climate based on field measurements," *Data in Brief*, vol. 48, p. 109217, 2023, doi: 10.1016/j.dib.2023.109217.

Dataset:

4. D. Amaripadath and S. Attia. "Field measurement dataset of a nearly zero-energy office building in temperate oceanic climate." Cambridge, Massachusetts, United States: Harvard Dataverse, version 01, 2022. doi: 10.7910/DVN/NLEAKA.

Conversion factor:

5. Calculation of CO₂. Available online: www.encon.be/en/calculation-co2 (accessed on 5 July 2022).

7.2 Key Contacts

1. Deepak AMARIPADATH

Postdoctoral Research Scholar, School of Geographical Sciences and Urban Planning
Arizona State University
Email: deepak.amaripadath@asu.edu
Office: +1 (623) 275 2470

2. Shady ATTIA

Professor in Sustainable Architecture & Building Technology
Head of Sustainable Building Design Lab
University of Liège
Email: shady.attia@uliege.be
Office: +32 (0) 4 366 91 55

1. Introduction & Climate

1.1 Introduction

The objective of the study is to analyse the thermal resilience performance based on the monitoring data of two test lecture rooms at KU Leuven.

A nZEB is realised at the Technology campus Ghent of KU Leuven (Belgium) on top of an existing university building (see Figure 1). The building consists of 4 zones: 2 large lecture rooms, a staircase and a technical room. The lecture rooms have a floor area of 140 m², a volume of 380 m³ and a maximum capacity of 80 students each. The building is designed according to the passive house standard. The lecture rooms are designed as identical zones with different thermal masses.



Fig. 1. EXTERIOR VIEW, SOUTHWEST, TEST-LECTURE ROOMS, GHENT

1.2 Local Climate

Location: The building is located on the Technologie Campus Ghent (51° 3' 14" N, 3° 43' 18" E), KU Leuven. The campus is situated in a high-density urban area.

Climate Zone: The building is located in a temperate climate zone 4A (ASHRAE) (Figure 2). According to the Köppen climate system, Belgium has a moderate sea climate (type Cfb) with relatively mild winters, mild summers and precipitation throughout the year.

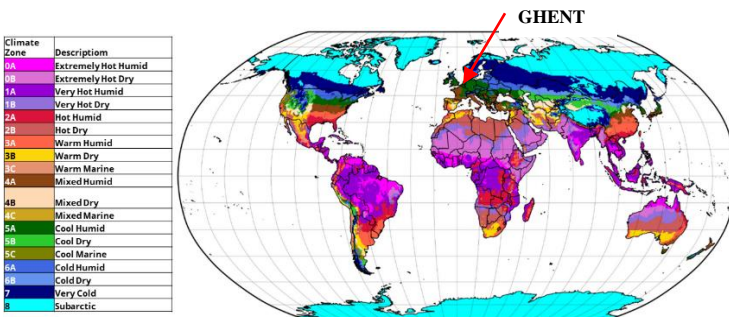

Fig. 2. CLIMATE MAP (ASHRAE 169 - CLIMATE DATA FOR BUILDING DESIGN STANDARDS)

Table 1. KEY INFORMATION ABOUT THE BUILDING

Location	Ghent, Belgium
Building Type	Educational Building
Retrofit (Y/N)	N
Surroundings (Urban/Rural)	Urban
Year of completion	2012
Floor Area (m²)in each floor	140 m ²
Shape coefficient (m)	2.9
Openable Area to Floor Area Ratio (%)	13%
Window to wall ratio	26.5%
Climate Zone	Temperate (4A)
No of days with Te max >25	46
Cooling Season Humidity	65%
Heating degree days 12/20 (Kd)	2064

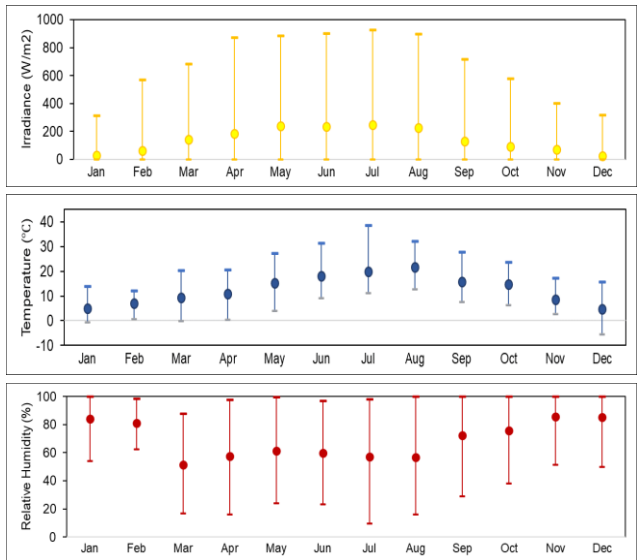

Fig. 3. MEAN, MAXIMUM AND MINIMUM EXTERNAL CONDITIONS OF 2022 IN GHENT, USING THE OBSERVATIONAL DATA FROM WEATHER STATION AT SITE

Building Information

2. Building

2.1 Envelope and Construction

The lower room (E120) has a brick external wall with external insulation, while the upper room (E220) has a lightweight timber frame external wall with the same U-value. Both lecture rooms have concrete slab floors. This results in a light (2nd floor) and a medium (1st floor) thermal mass. The windows are triple glazed and have a g-value of 0.52. The window-to-wall ratio is 27% in the southwest façade and 26% in the northeast façade. The window-to-floor ratio is 13%. The building is very airtight: lecture room 1 and 2 have an airtightness of 0.47 h⁻¹ and 0.29 h⁻¹ respectively. The windows are provided with internal and external solar shading. The external solar shading consists of moveable screens on the southwest façade, which are automatically controlled and have a manual overrule. The shading is activated when the radiation on the façade exceeds 250 W/m². Occupancy is tracked by an Acurity 3D vertical optical counting system installed in the lecture rooms, 1 m from the door entrance.

Table.2 INFORMATION PLANNING, OPERATION AND USE

Information on planning, operation and use

Object use	Educational Building
Integral planning process	KU Leuven
Technical management	Building management system (BMS) by KU Leuven
Energy monitoring	Eltako counter monitoring energy used (KWh) by the HVAC

Table. 3 BUILDING PROPERTIES

Property	Unit	Value
Max hours of occupancy	h/week	30
Window U-value	W/(m ² K)	0.65
Window g-value	-	0.52
Wall U-value	W/(m ² K)	0.15
Roof U-value	W/(m ² K)	0.14
Floor U-value	W/(m ² K)	0.15
Window to wall ratio (WWR)	%	26.5
Air Tightness (@50Pa)	1/h	0.41 (E120) 0,29 (E220)

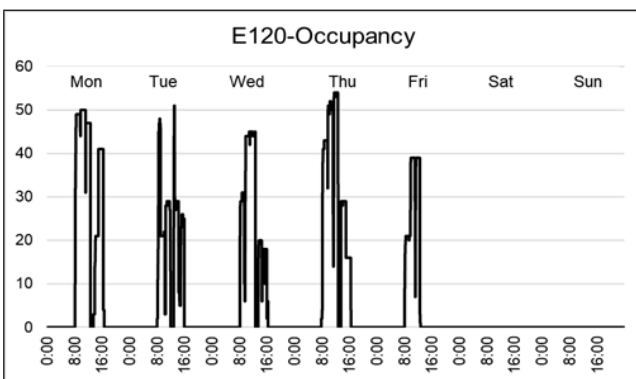

Fig. 4. TYPICAL WEEKLY OCCUPANCY OF E120

Table. 4 HOURS OF OCCUPANCY IN 2022

Test Lecture rooms	E120	E220
% of occupied hours	19.5%	13.1%

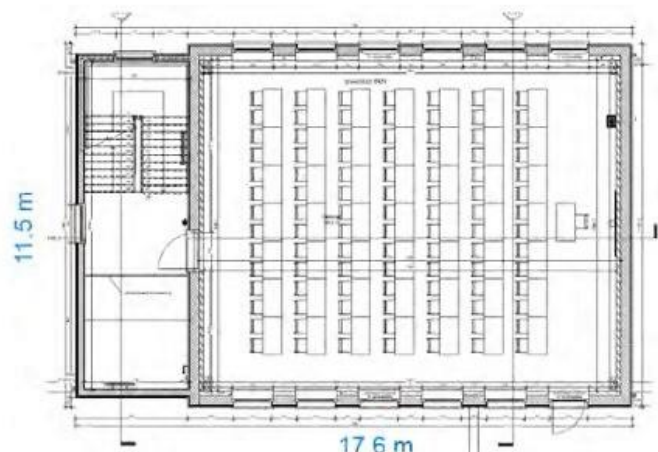
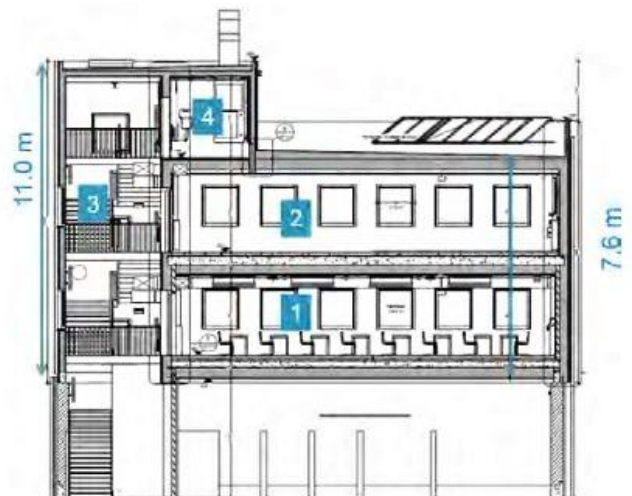

Fig. 5. SECTION (TOP) AND PLAN (BOTTOM) OF THE TEST LECTURE ROOMS

2. Building

2.2 Energy Systems

The AHU operates from Monday to Friday from 7:30 a.m. to 6:00 p.m. and is turned off during the weekends as there are no classes. The building is equipped with an all-air system with balanced mechanical ventilation. Air is supplied via a displacement ventilation system in both lecture rooms. The supply and extract fans supply a minimum airflow of 400 m³/h and a maximum of 4400 m³/h. Four Variable Air Volume (VAV) boxes, regulated by Proportional Integral (PI) signals, control the airflow of the Demand-Controlled Ventilation (DCV) system based on CO₂ and temperature demands. The PI control compares the level of deviation of each room temperature from its 22°C setpoint and the level of deviation of each room's CO₂ concentration from an assigned threshold of 1000 ppm.

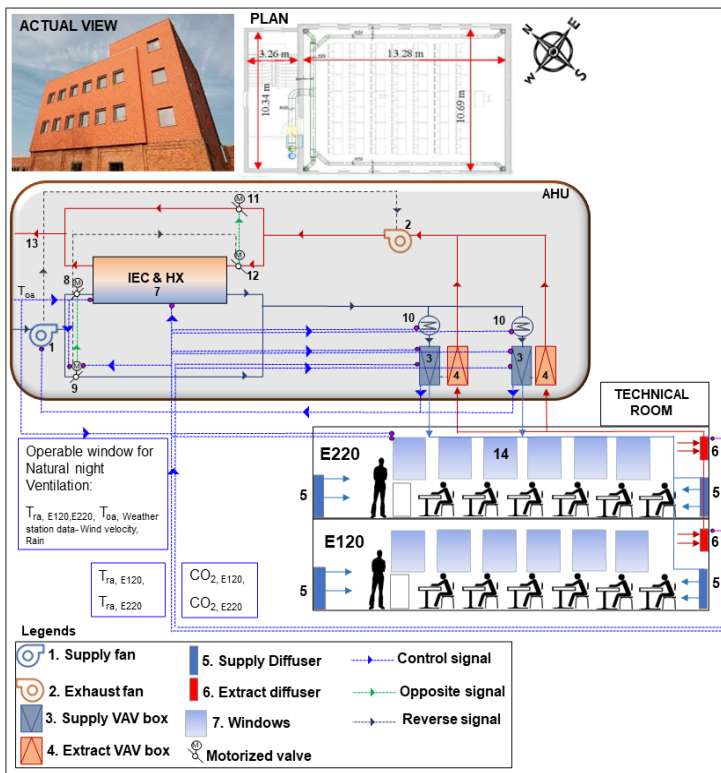

Fig.6 SCHEMATIC DIAGRAM OF THE TWO TEST LECTURE ROOMS AND THE AHU

Heating System

For heating purposes, the air is preheated by air-to-air heat recovery, i.e., two cross flow plate heat exchangers connected in series, with an efficiency of 78%. Additionally, 7.9 kW heating coils are integrated into the supply ducts in each lecture room. The heat production system consists of a condensing wood pellet boiler with an internal storage of 600 l. The maximum heating power is 8 kW and the maximum efficiency is 106 %.

Cooling System

The building is cooled by three techniques of ventilative cooling: (1) natural night ventilation (opening the windows on both sides of the building), (2) a modular bypass in the AHU and (3) Indirect Evaporative Cooling (IEC) with a maximum capacity of 13.1 kW.

Electrical Power Supply

Electrical power is supplied by the grid.

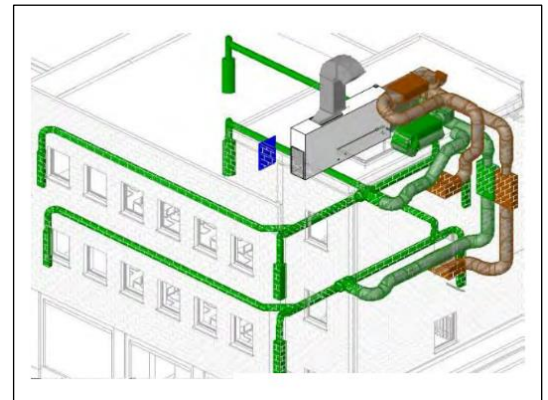

Fig.7 VISUALISATION OF AIR DISTRIBUTION (SUPPLY IN GREEN, RETURN IN BROWN)



Fig.8 WOOD PELLET BOILER (LEFT) AND HEATING COILS IN THE AIR HANDLING UNIT (RIGHT)

Resilient Cooling

3. Resilient Cooling

3.1 Principles

The building is cooled by three techniques of ventilative cooling: (1) natural night ventilation (opening windows on both sides of the building), (2) a modular bypass in the AHU and (3) indirect evaporative cooling (IEC) with a maximum capacity of 13.1 kW. In addition, all the windows on the southwest façade are solar automated.

Table.5 RESILIENT COOLING STRATEGIES IN THE BUILDING

1. Reducing Heat Loads to People and Indoor Environments	
1.1. Solar Shading Technologies	
1.2. Cool Envelope Materials	
1.3. Glazing Technologies	
1.4. Ventilated Façades	
1.5. Green Roofs and Green Façades	
2. Reducing Heat Loads to People and Indoor Environments (Production, Emission and combined)	
2.1. Ventilative cooling	
2.2. Thermal Mass Utilization	
2.3. Evaporative Cooling	
2.4. Sky Radiative Cooling	
2.5. Compression Refrigeration	
2.6. Adsorption Chiller	
2.7. Natural Heat Sinks	
2.8. Radiant Cooling	
3. Increasing Personal Comfort Apart from Space Cooling	
3.1. Comfort Ventilation and Elevated Air Movement	
3.2. Micro-cooling and Personal Comfort Control	
4. Removing Latent Heat from Indoor Environments	
4.1. Dehumidification	

3.2 Resilient Cooling Technology

I REDUCE EXTERNAL HEAT GAINS

Advanced solar shading

All windows have manually operable external screens. The screens on the southwest façade were additionally automated (shading ON for 15 minutes when the global solar radiation on the windows exceeds 250 W/m²).



Fig.9 SOLAR SHADING ON SOUTH-WEST FACADE

II REMOVING HEAT FROM INDOOR-ENVIRONMENT

Adiabatic cooling

During the cooling season in the daytime, the lecture rooms are passively cooled by an Indirect Evaporative Cooling (IEC) with a maximum capacity of 13.1 kW from 7:30 am to 6:00 pm. It is composed of wet channels equipped with cooling pads wetted with water originating from a feeder tank. A secondary flow of air, in this case the exhaust air from the lecture rooms, flows through the cooling pads. Clean outdoor air also enters the AHU through a supply fan. When the IEC operation is triggered, all the supply flow is completely diverted through the IEC and the flow is maximum. The modular bypass and the IEC are part of the AHU.

Ventilative cooling

Night ventilation relies on cross ventilation through openable windows on both sides of the room. The system consists of 10 motorised bottom hung windows (1.29 × 1.38 m², maximum opening angle of 8.8°) with a chain actuator. There are 6 windows on the southwestern side and 4 on the northeastern side of the lecture room, located at a height of 1 m from the ground. The total effective opening area of these windows is 4.0% of the floor area.

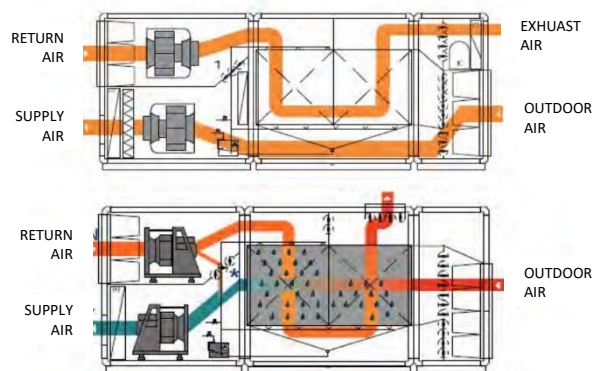

Fig.10 SCHEME OF MODULAR BYPASS AND INDIRECT EVAPORATIVE COOLING



Fig.11 PRINCIPLE OF NATURAL NIGHT VENTILATION (LEFT) AND OPERABLE WINDOW (RIGHT)

3.3 Control Strategy Description

Table.6 CONTROL STRATEGY PARAMETERS

Parameter	Input/Output/Target	Value
Zone temperature (T_i), Zone relative Humidity (RH _i)	Input	Variable
External Temperature (T_e), Wind speed (V_a), Solar Radiation, Rainfall	Input	Variable
Time, date	Input	Variable
Zone set point Temperature	Target	22°C
Supply Temperature low limit	Target	14°C
Indirect Evaporative Cooling (IEC)	Output	0%-100%
Bypass	Output	0%-100%
Window Position	Output	0%-100%
Solar shading position	Output	0%-100%

1. External solar shading

The two test lecture rooms have automated external blinds on the southwest façade windows, which are deployed when the following conditions are met:

- Radiation on the façade > 250 W/m²
- Solar shading remains ON/OFF for at least 15 min.

2. Control strategy of AHU during occupancy

During the daytime cooling season, the lecture rooms are passively cooled by an IEC if the following conditioned are detected:

- $T_i \geq 22^\circ\text{C}$ (set point) + 4°C
- IEC is active until $T_i \leq 22^\circ\text{C}$
- Outdoor air temperature (T_e) > 22°C
- If $16^\circ\text{C} < T_e < 22^\circ\text{C}$, the bypass on the heat exchanger is active
- If $14^\circ\text{C} < T_e < 16^\circ\text{C}$, 50% of the fresh air is sent through the heat exchanger and 50% is bypassed
- $T_e < 14^\circ\text{C}$, the bypass is switched off

3. Control strategy of natural night ventilation

Night ventilation is activated between 10:00 pm and 6:00 am when the following criteria are met:

- April 1st < day of the year < October 31st
- Maximum T_i of the previous day > 23°C
- $T_i >$ heating set point = 22°C
- $T_i > T_e + 2^\circ\text{C}$ and $T_e > 12^\circ\text{C}$
- RH_i < 70%
- Wind velocity < 10 m/s and no rainfall
- Windows remain open/closed for at least 15 min.

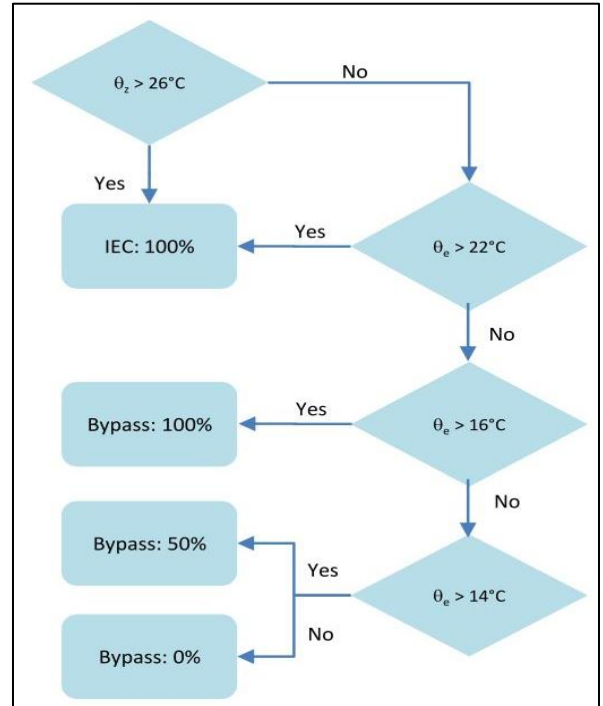

Fig.12 CONTROL STRATEGY IEC

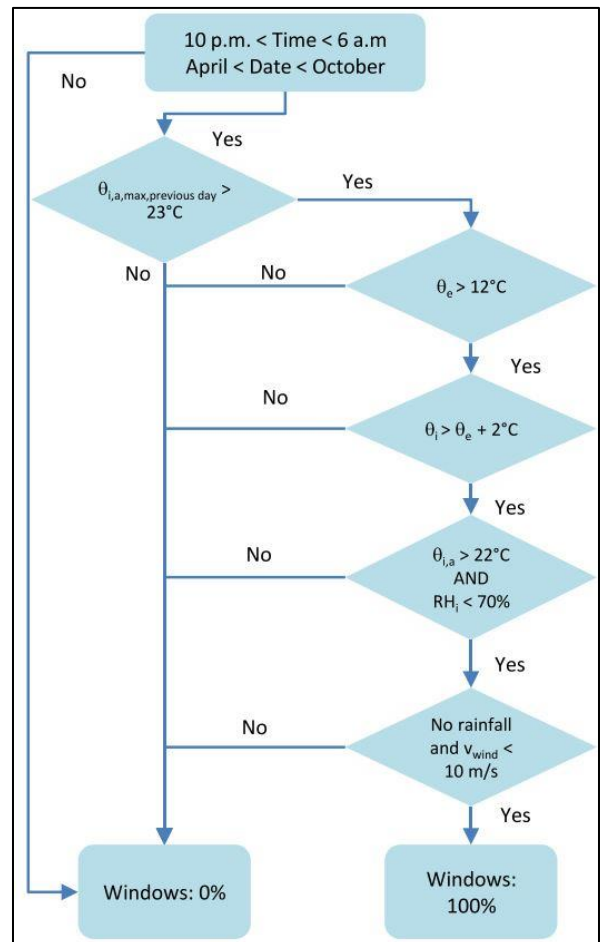

Fig.13 CONTROL STRATEGY NATURAL NIGHT VENTILATION

4. KPI Evaluation

Note: for the KPI assessment, only lecture room E120 has been analysed due to absence of complete measurement data in E220.

4.1 Thermal Comfort KPIs

Hours of exceedance (HE) 169 h/a

Occupied hours outside the range of 26°C

% of occupied hours above threshold 0.4%

Percentage of occupied hours outside the range of 26°C

Indoor Overheating Degree IOD 0.004 C

Hourly summation of the positive values of the difference between the operative temperature of the occupied building thermal zones and the zonal thermal comfort limit temperature (26°C), divided by the sum of the zonal occupied hours.

Ambient Warmness Degree AWD 4.10 C

Hourly summation over the summertime period of the positive values of the difference between the outdoor air temperature and a fixed base temperature (18°C), divided by the total number of building occupied hours.

Hours above 18°C 2000 Hours

Total hours in a year when outdoor temperature is above 18°C.

Overheating Escalation Factor OEF 0.00

An indicator of the resistivity of a building to climate change and associated overheating risk. OEF in the test lecture room < 1, indicating that the building can suppress outdoor thermal stress.

4.2 Heat Stress KPIs

Maximum Standard Effective Temperature (SET) 29.9 C

The equivalent dry bulb temperature of an isothermal environment at 50% relative humidity, still air and 50% relative humidity in which a subject, wearing standardised clothing for the activity concerned, would experience the same heat stress and thermoregulatory strain as in the actual test environment.

Passive Survivability Yes (hourly)

Ability to maintain safe indoor thermal conditions in the absence of active cooling

4.3 Carbon dioxide (CO₂) emissions

Annual amount of CO₂ emissions 5,720 gCO₂/m².a

Annual electricity use for space cooling is 1461.4 kWh/a (i.e., 10.4 kWh/(m².a) for 140 m² conditioned floor area), and the carbon dioxide (CO₂) emissions factor for electricity is 0.55 tCO₂/MWh (Determination of market-based CO₂ emissions factor for Belgium).

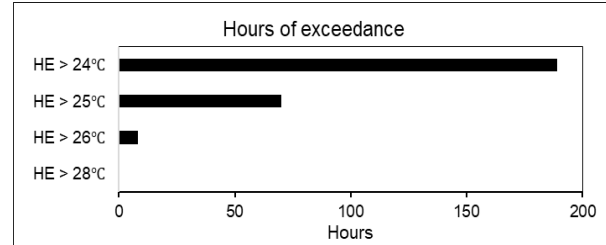

Fig.14 HOURS OF EXCEEDENCE

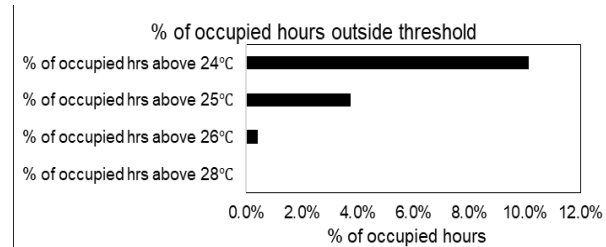

Fig.15 % OF OCCUPIED HOURS OUTSIDE THRESHOLD

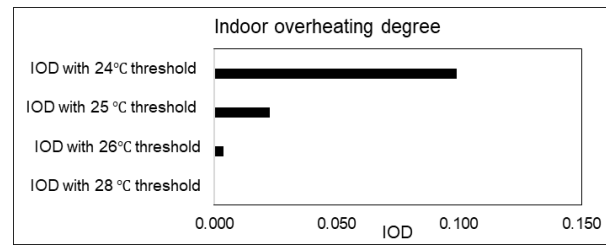

Fig.16 INDOOR OVERHEATING DEGREE

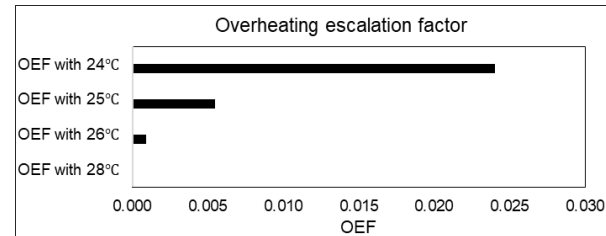

Fig.17 OVERHEATING ESCALATION FACTOR

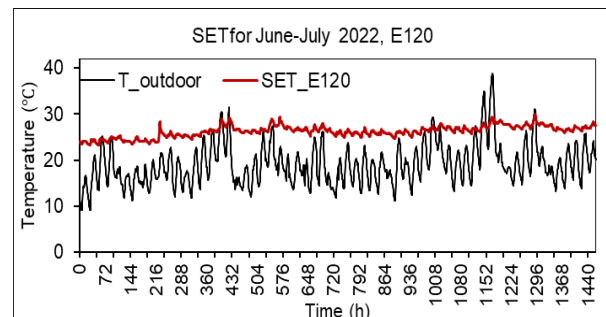

Fig.18 HOURLY SET FOR JUNE AND JULY

Performance Evaluation

5. Performance Evaluation

5.1 Energy

The total energy consumption of the HVAC (Electricity consumption for the ventilation and indirect evaporative cooling and does not include heating energy) in the measurement period January 2022 - December 2022 is around 2631.6 kWh. The HVAC was in operation for 3892 hours per year. The energy consumption during the summer period (April - September) is 1461.4 kWh.

In 2022, the AHU was active during the months of July and August, regardless of the absence of occupants. An experiment was set up during March to July, where the AHU was scheduled to be ON even when there was no occupancy. The IEC was also active based on the outdoor and indoor temperature thresholds. This resulted in high energy consumption in July and August. In June the HVAC consumed 510 kWh.

The IEC was active for 1332 hours between January 2022 and December 2022. Between April and September 2022, the IEC was active for 42% of the total AHU operating hours.

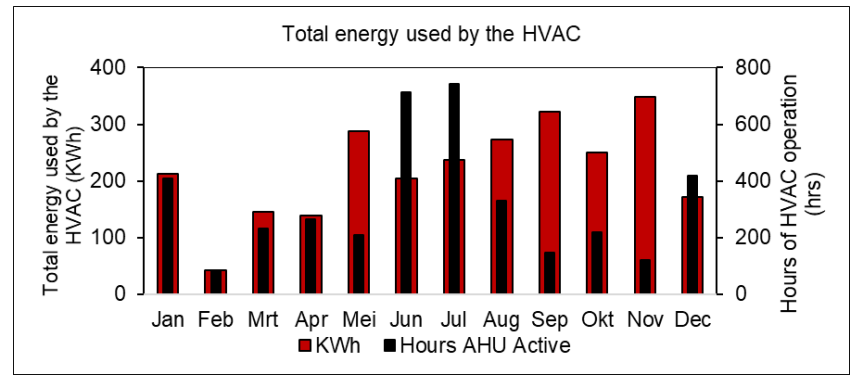

Fig.19 TOTAL ENERGY CONSUMPTION BY THE HVAC UNIT

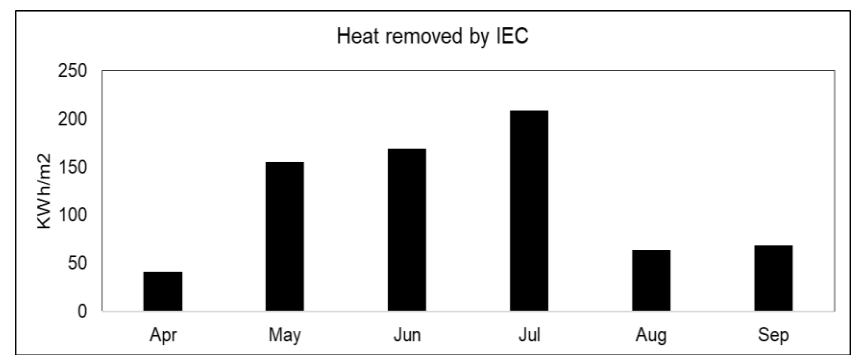

Fig.20 TOTAL HEAT REMOVED BY THE IEC DURING THE SUMMER PERIOD (APRIL - SEPTEMBER)

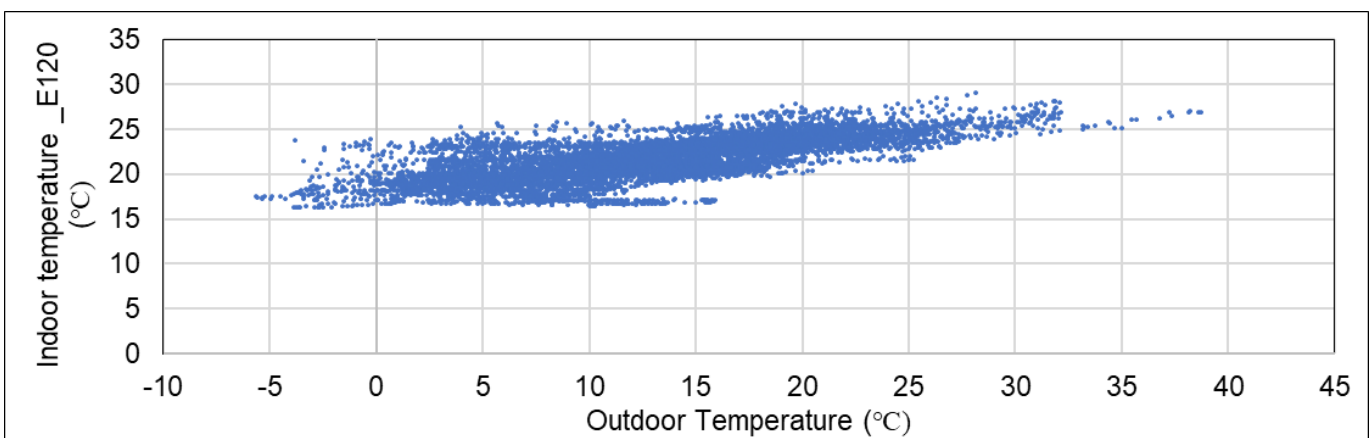

Fig.21 INDOOR TEMPERATURE VS OUTDOOR TEMPERATURE FOR E120 FOR 2022

The indoor air temperature is co-related to the outdoor air temperature and to the occupancy pattern. Figure 21 shows the indoor vs. outdoor temperature for the whole year 2022 for lecture room E120. As the outdoor temperature gets warmer (>18 °C), the indoor temperature in E120 increases from 23 °C to 25 °C. The highest outdoor temperature of 38.8 °C was recorded in July. However, due to the lack of occupancy in July, the mean indoor temperature was 23.7 °C. In August 2022, the mean indoor temperature at E120 was monitored at 25.1 °C.

5.2 Comfort monitoring

Indoor temperature and relative humidity were monitored in the lecture room E120. The data for the summer period (April - September) 2022 is shown in Figure 22.

- The average indoor temperature in E120 between April and September is 23 °C.
- Maximum indoor temperature of 29 °C was monitored during August due to high occupancy and high outdoor temperature. Mean temperature of 25.1 °C was monitored in August 2022.

In general, it can be stated for E120 that the comfort parameters during the cooling period are largely within the comfortable range. The indoor air humidity is within the optimal range (40-60%), with higher indoor humidity during the period between June and September.

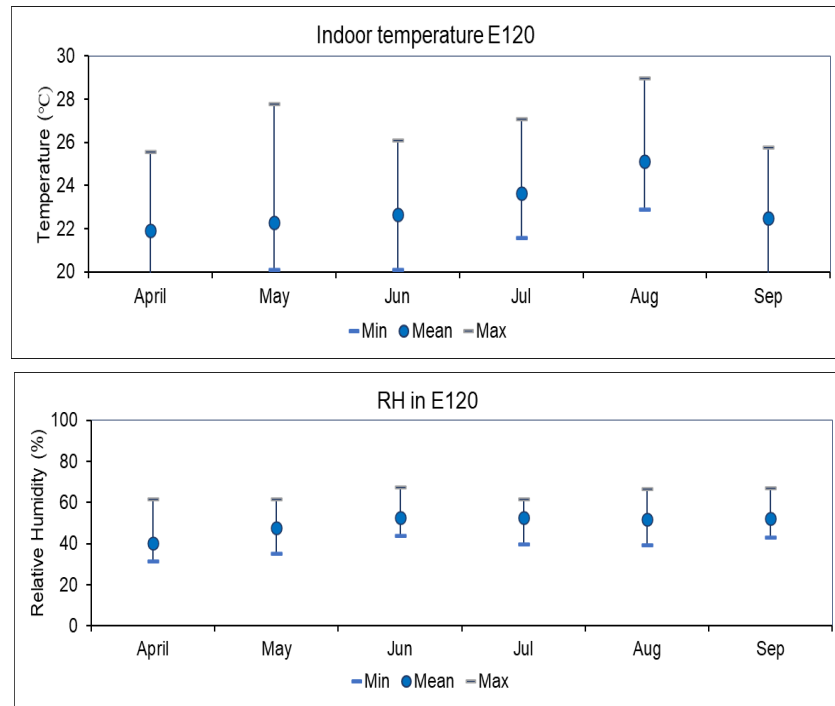

Fig.22 MINIMUM, MEAN AND MAXIMUM TEMPERATURE AND RELATIVE HUMIDITY IN E120 FOR SUMMER PERIOD

Table 7 TEMPERATURE AND CO₂ MONITORING

Temperature and CO ₂ measurements in E120	Value	Units
Average room temperature in the heating period (temperature outside < 12°C)	20.0	°C
Average room temperature in the summer months (temperature outside > 12°C)	22.9	°C
Overheating hours (T_E120 > 26°C) (hrs.)	169	h
Share of overheating hours (T_E120 > 26°C) in total annual hours	2	%
CO ₂ concentration in E120 > 1000ppm	169	h
Share of CO ₂ concentration in E120 (> 1000)ppm	2	%

5.3 CO₂ monitoring

The CO₂ concentration of E120 is shown for the summer period between April and September 2022. The CO₂ monitoring shows that E120 was not occupied between July and August of 2022 due to the summer break.

From April to September 2022, the CO₂ concentration in E120 is around 450 ppm, the CO₂ concentration on June 16th 2022, increased from 450 ppm to 1432 ppm due to a large group of students entering the classroom at the same time. However, the HVAC system was able to bring the ppm back down to 600 ppm within 15 minutes of operation.

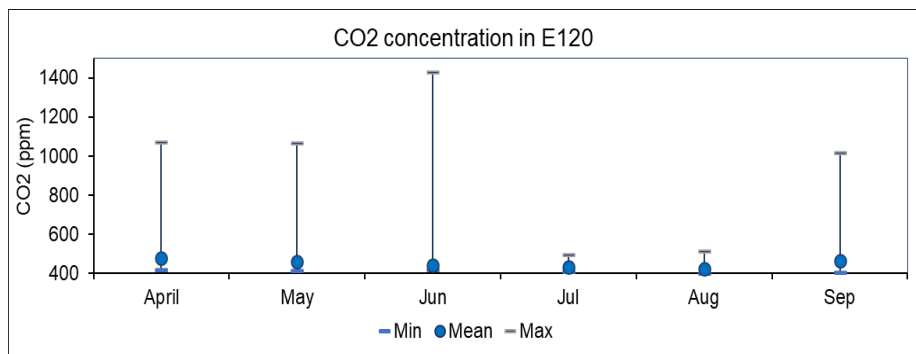

Fig.23 MINIMUM, MEAN AND MAXIMUM CO₂ CONCENTRATION IN E120 FOR THE SUMMER PERIOD

5.4 Evaluation of the resilient cooling strategy during heatwave period

Between July 13th and 19th 2022, Belgium experienced a heatwave period with a maximum outdoor temperature of 38.8°C recorded on site. However, due to the lack of occupancy during this heatwave period, the hottest period in June (13th-19th June) (Figure 24) was selected for evaluation, when an outdoor temperature of 32.2°C was recorded.

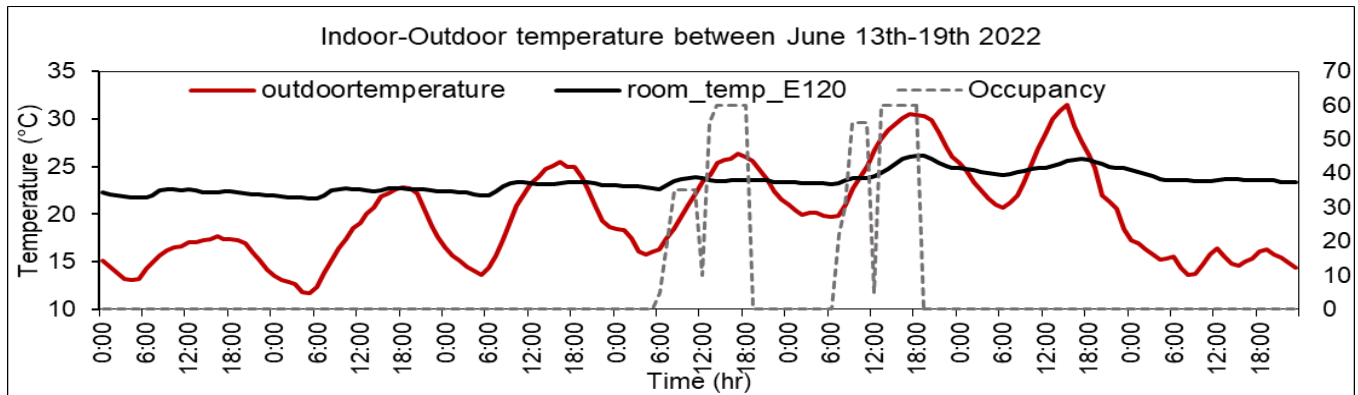

Fig.24 OUTDOOR AND INDOOR TEMPERATURE AND OCCUPANCY DURING THE HEATWAVE PERIOD IN JUNE - JULY 2022

During the June heatwave period (13th to 19th), the peak indoor temperature of 26.2 °C was monitored on June 17th. The time taken for the building to absorb the shock i.e., to deviate from its designed indoor temperature of 24°C, is 5.6 hours. The time taken to recover, i.e., return indoor temperature to 24 °C, is 11.3 hours.

Solar shading, IEC and natural night ventilation operation during heatwave period

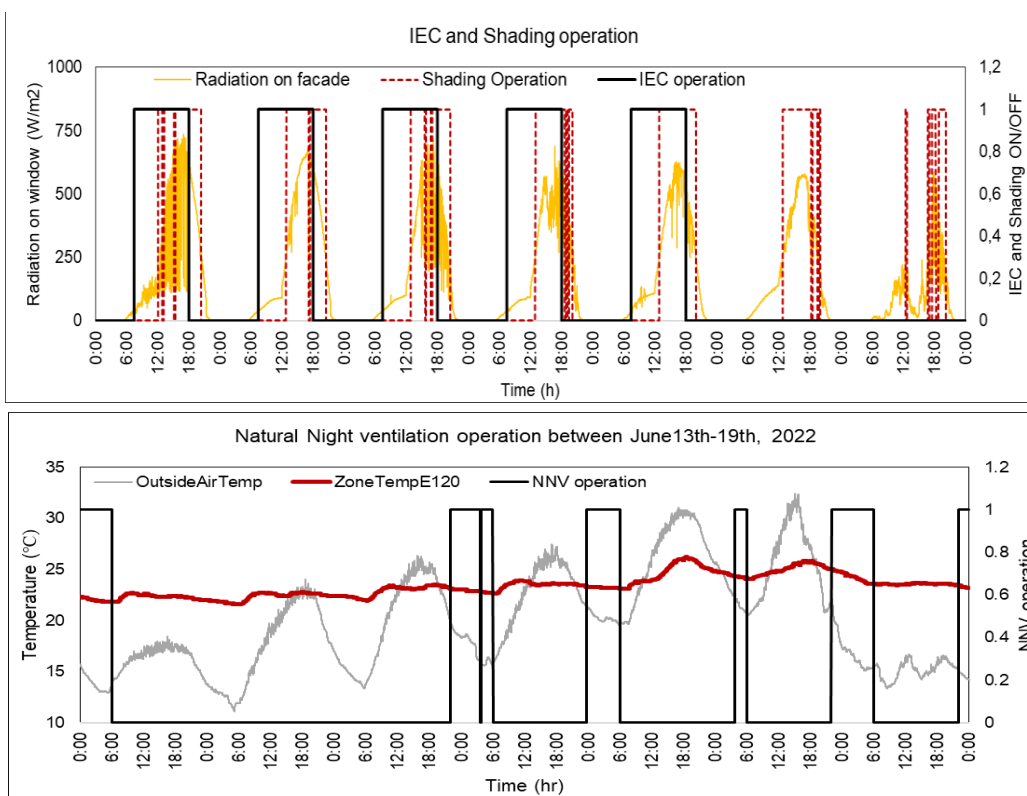

Fig.25 IEC, SHADING AND NNV OPERATIONS DURING THE WARM WEEK (13TH- 19TH JUNE)

IEC was active from 7:30 am to 6:00 pm due to high indoor and outdoor temperatures. IEC operated for 10.5 hours (maximum operating time in one day) from Monday, June 13th to Friday, June 17th, 2022. The solar shading was in operation based on the radiation on the façade.

Natural night ventilation was active for 58% of the total operating time for the entire week. The average night temperature for the entire week is 23.2 °C.

Note: During 2022, the shading control had a problem with its input parameter (instead of taking the 15-minute running average as input, it took the 15-minute average radiation). Post detection, this problem was solved in October 2022.

6. Discussion, Lessons Learned

6.1 Summary

Two test lecture rooms are monitored at 1-minute intervals to assess the thermal comfort, heat stress, energy consumption and thermal resilience. In this report, the 2022 data was monitored due to certain data gaps and additionally low occupancy period in 2021 and 2020. Lecture room E120 was analysed due to the complete data set and especially the summer period (April to September) was evaluated in depth.

It should be noted that for energy consumption, an Eltako meter monitors the energy consumed by the HVAC. For the IEC, the heat load removed by the IEC could be calculated based on the supply and extract air and the measured air flow rate. Additional monitoring is required to measure parameters such as air flow rate through window opening and surface temperatures.

6.2 Resilience performance of the building

Analysis of the monitoring data from the lecture room (E120) shows:

- The lecture room is able to maintain thermal comfort even during heatwaves. There is a low level of heat stress (occupied hours above 28°C SET is 21 hours).
- The room is resilient to overheating during heatwaves. The absorption and recovery capacity of the building is medium, i.e., it takes more than 1 hour but less than 24 hours to absorb and to recover from a thermal shock.
- The IEC is operational during the summer period and is resilient to external shocks.
- Solar shading reduces solar heat gains during the day.
- NNV is resilient and helps to reduce the peak temperature during the day by exhausting heat from the lecture room at night.
- The buildings HVAC system is also resilient to ventilation shocks and can reduce the sudden rise in CO₂ concentration in less than 30 minutes.

7. References & Key Contacts

7.1 References

- ASHRAE, ANSI/ASHRAE Standard 169-2013, Climatic Data for Building Design. Atlanta: ASHRAE, 2013.
- H. Breesch, B. Merema, and A. Versele, “Ventilative Cooling in a School Building: Evaluation of the Measured Performances,” *Fluids* 2018, Vol. 3, Page 68, vol. 3, no. 4, p. 68, Sep. 2018, doi: 10.3390/FLUIDS3040068.
- Chen, Zhang et al. 2023. “IEA EBC Annex 80 - Dynamic Simulation Guideline for the Performance Testing of Resilient Cooling Strategies - Version 2. DCE Technical Reports No. 306.” : 30.
- Hamdy, Mohamed, Salvatore Carlucci, Pieter Jan Hoes, and Jan L.M. Hensen. 2017. “The Impact of Climate Change on the Overheating Risk in Dwellings—A Dutch Case Study.” *Building and Environment* 122: 307–23.
- International Energy Agency (IEA). 2018. *Ventilative Cooling Case Studies - IEA-EBC Annex 62 Ventilative Cooling*. http://www.iea-ebc.org/Data/publications/EBC_Annex_62_Design_Guide.pdf.
- Sengupta, Abantika et al. 2023. “Impact of Heatwaves and System Shocks on a Nearly Zero Energy Educational Building: Is It Resilient to Overheating?” *Building and Environment* 234(February).
- Roques, Fabien, Nicolas Hary. 2021. “Determination of market-based CO₂ emission factor for Belgium”. <https://www.creg.be/sites/default/files/assets/Consult/PRD2364Annex.pdf>

7.2 Key Contacts

- Hilde Breesch, Department of Civil Engineering, KU Leuven
hilde.breesch@kuleuven.be
- Abantika Sengupta, Department of Civil Engineering, KU Leuven
abantika.sengupta@kuleuven.be
- Bram Gezels, Department of Civil Engineering, KU Leuven
bram.gezels@kuleuven.be

Introduction & Climate

1. Introduction & Climate

1.1 Introduction

The building was constructed in 1958 and provides space for classrooms, meeting rooms, and gyms. It was built according to very old energy requirements with a concrete block-brick veneer exterior wall, block partitions, concrete floor, concrete roof with insulation and two single-glazed windows. The building has a gross floor area of around 1152 m², with 2 flats. The occupants are mainly children between the ages of 5 and 10. In terms of mobility, care is taken to ensure that the building users can cover as much of their distances as possible on foot, by bicycle or by public transport.



Fig.1 EXTERIOR VIEW, SOUTHEAST VIEW, SCHOOL PROJECT MONTREAL

Table.1 KEY INFORMATION ABOUT THE BUILDING

Location	Montreal, Canada
Building Type	School
Retrofit (Y/N)	N
Surroundings (Urban/Rural)	Urban
Year of Completion	1958
Floor Area (m²)	1152
Shape	Rectangular
Openable Area to Floor Area Ratio (%)	25%
Window to Wall Ratio (%)	60%
Climate Zone	Temperate (6A)
Heating Degree days 12/20 (Kd)	3446

1.2 Local Climate

Location: The building is located in the Ahuntsic-Cartierville district of Montreal, in 10600 Av. Larose (45.5798° N, 73.650° W).

Climate Zone: 6A (ASHRAE), DFA (Historical Koppen-Geiger Map), and DFB (Future Koppen-Geiger Map)

Climate Zone	Description
0A	Extremely Hot Humid
0B	Extremely Hot Dry
1A	Very Hot Humid
1B	Very Hot Dry
2A	Hot Humid
2B	Hot Dry
3A	Warm Humid
3B	Warm Dry
3C	Warm Marine
4A	Mixed Humid
4B	Mixed Dry
4C	Mixed Marine
5A	Cool Humid
5B	Cool Dry
5C	Cool Marine
6A	Cold Humid
6B	Cold Dry
7	Very Cold
8	Subarctic

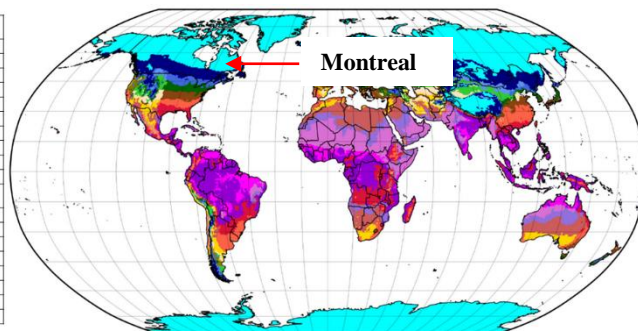

Fig.2 CLIMATE MAP (ASHRAE 169 - CLIMATE DATA FOR BUILDING DESIGN STANDARDS)

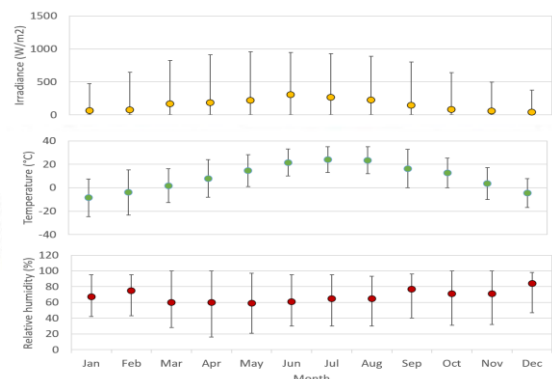

Fig. 3 MEAN, MAXIMUM AND MINIMUM EXTERNAL CONDITIONS IN MONTREAL USING MEASURED DATA

2. Building

2.1 Envelope and Construction

The building is a school property with classrooms. It was completed in 1958.

Special features of the building envelope and construction

- Solid construction built to the lowest energy efficiency standard, 2 stories
- One main part of solid construction
- Reinforced concrete skeleton with curtain-type brick façade
- Box-type has two windows, each of which is single-glazed
- No exterior solar shading installed. Interior blind roll shading is used
- No cooling system
- Windows can be opened 25% at a time

Table.2 INFORMATION PLANNING, OPERATION AND USE

Information on planning, operation and use	
Object use	Classrooms
Integral planning process	Quebec government, as the owner, actively managed the planning process.
Technical management	Own operational management through self-organization of the occupants with the support of external maintenance companies.
Energy monitoring	There are interior temperature sensors in four classrooms and an exterior weather station on the roof of the building.

Table.3 BUILDING PROPERTIES

Property	Unit	Value
Hours of occupancy	h/week	40
Window U-value	W/(m ² K)	2.4
Window g-value	-	0.65
Wall U-value	W/(m ² K)	0.45
Roof U-value	W/(m ² K)	0.24
Floor U-value	W/(m ² K)	0.24
Window to Wall Ratio	%	60
Air-tightness (@ 50 Pa)	1/h	3.9

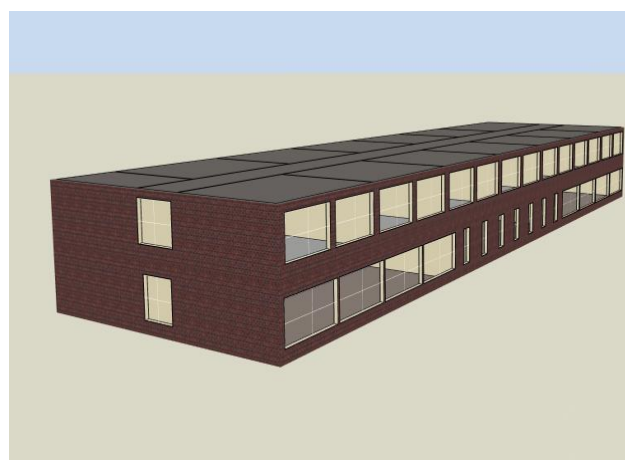

Fig.4 VOLUMETRIC MODEL (SAINTE ANTOINE SCHOOL)

2. Building

2.2 Energy Systems

Schematic design of Energy System

Heating is provided by an electric baseboard system. Electricity is supplied by a municipal grid system. Hot water is provided by an electric boiler. Cooling is provided by natural ventilation through the opening of exterior and interior windows. Four classrooms, as marked in Figure 5, located on the second floor (i.e., rooms 200, 203, 208, and 212) were selected according to different orientations for comparison purposes to measure the indoor thermal conditions.

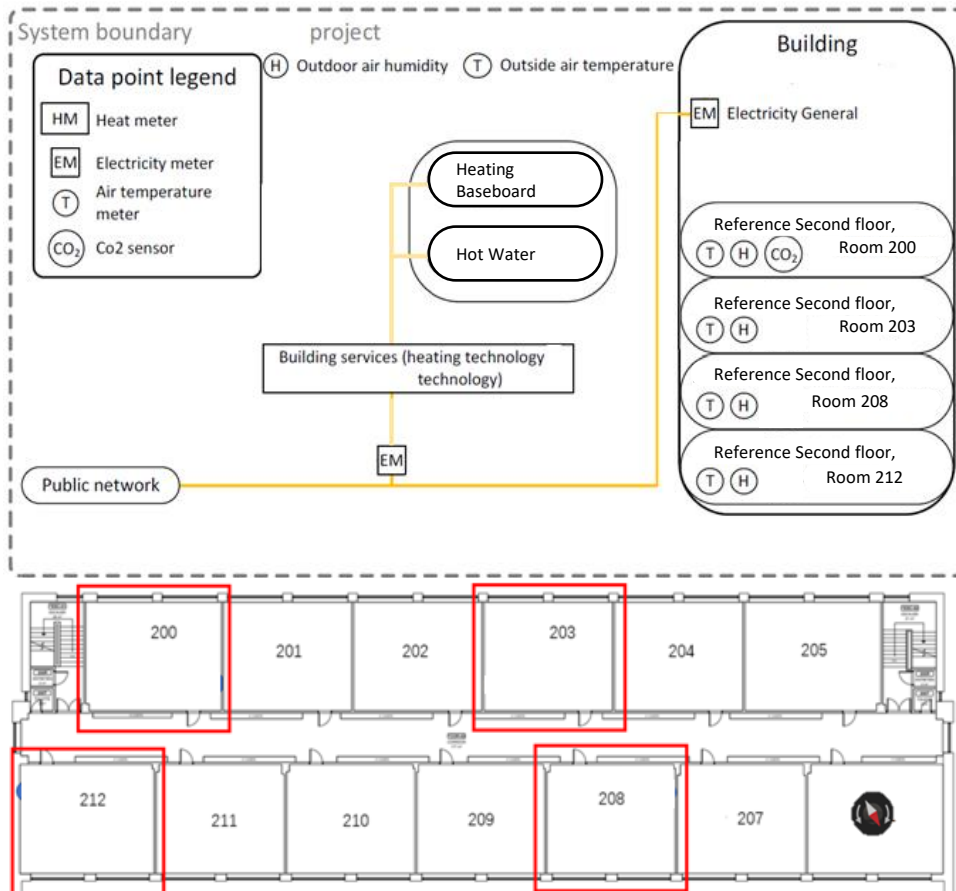

Fig.5 SCHEMATIC DIAGRAM OF THE SAINT ANTOINE PROJECT, BUILDING TECHNOLOGY AND MEASUREMENT CONCEPT (TOP). SECOND-FLOOR PLAN OF THE SAINT ANTOINE SCHOOL WITH THE IDENTIFICATION OF THE FOUR ROOMS THAT CONTAIN INTERNAL TEMPERATURE, RH AND CO₂ SENSORS

Description of Energy System

Heating System

The building is heated by an electric baseboard heating system in each room. The electric boiler is used for hot water.

Cooling System

The building is cooled by natural ventilation. Exterior windows primarily provide natural ventilation by opening 25% of the total window area. Based on measured data, occupants open windows when the indoor temperature reaches 23 °C in the southeast classrooms and 24 °C in the northwest classrooms.

Electricity Supply

Electricity consumption is supplied by the public grid. The electricity demand is made up of the demand of the occupants and the demand of the building services.

Resilient Cooling

3. Resilient Cooling

3.1 Principles

In principle, the rooms are cooled by introducing natural ventilation air into the room. All windows have interior shading (blind roll shading with a solar reflectance index of 0.7). The building structure is made of concrete for thermal mass utilisation.

No mechanical cooling or ventilation is used in the building.

3.2 Structure of resilient cooling technology

I REDUCE EXTERNAL HEAT GAIN

Interior Shading

Blind roll shading is used to reduce external heating gain through the windows

II REMOVING HEAT FROM INDOOR ENVIRONMENT

Ventilation System

Ventilation: Cool air can be brought into the building by opening the exterior windows. These windows are also responsible for extracting the exhaust air from the room. The internal windows and doors provide cross-ventilation between rooms.

Thermal Mass:

The building is a concrete structure. It can absorb the heat during the day and releases it during the night.

Table.3 STRUCTURE OF THE SYSTEM

1. Reducing Heat Loads to People and Indoor Environments	
1.1. Solar Shading Technologies	
1.2. Cool Envelope Materials	
1.3. Glazing Technologies	
1.4. Ventilated Façades	
1.5. Green Roofs and Green Façades	
2. Reducing Heat Loads to People and Indoor Environments (Production, Emission and combined)	
2.1. Ventilative cooling	
2.2. Thermal Mass Utilization	
2.3. Evaporative Cooling	
2.4. Sky Radiative Cooling	
2.5. Compression Refrigeration	
2.6. Adsorption Chiller	
2.7. Natural Heat Sinks	
2.8. Radiant Cooling	
3. Increasing Personal Comfort Apart from Space Cooling	
3.1. Comfort Ventilation and Elevated Air Movement	
3.2. Micro-cooling and Personal Comfort Control	
4. Removing Latent Heat from Indoor Environments	
4.1. Dehumidification	

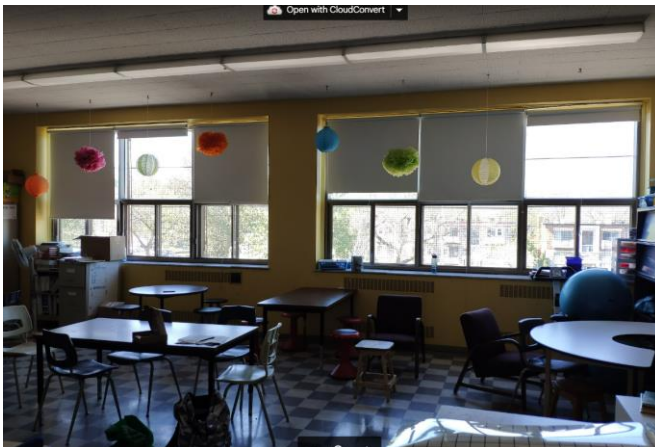

Fig.6 PHOTOS OF EXTERIOR WINDOWS WITH INTERIOR SHADING (LEFT), INTERIOR WINDOW AND DOOR (RIGHT)

3. Resilient Cooling

3.3 Design simulation

To evaluate the indoor thermal condition of the school building under different scenarios, the validated Building Simulation Model (BSM) based on the measured indoor air temperature must be used. Since many building parameters are uncertain in this case, these parameters must first be calibrated so that the indoor air temperature prediction from the BSM reflects the measured indoor air temperature. In order to achieve this, a novel calibration methodology is used as shown in Figure 8 (Baba et al., 2022). The results presented in Figure 9 show that the calibrated BSM achieves a high level of accuracy as indicated by the Root Mean Square Error (RMSE) of less than 0.6 °C, the Normalised Mean Bias Error (NMBE) of less than 2%, the Maximum Absolute Difference (Baba et al., 2022) of less than 1.9 °C, and the 1 °C Percentage Error Criteria (Baba et al., 2022) of less than 10%.

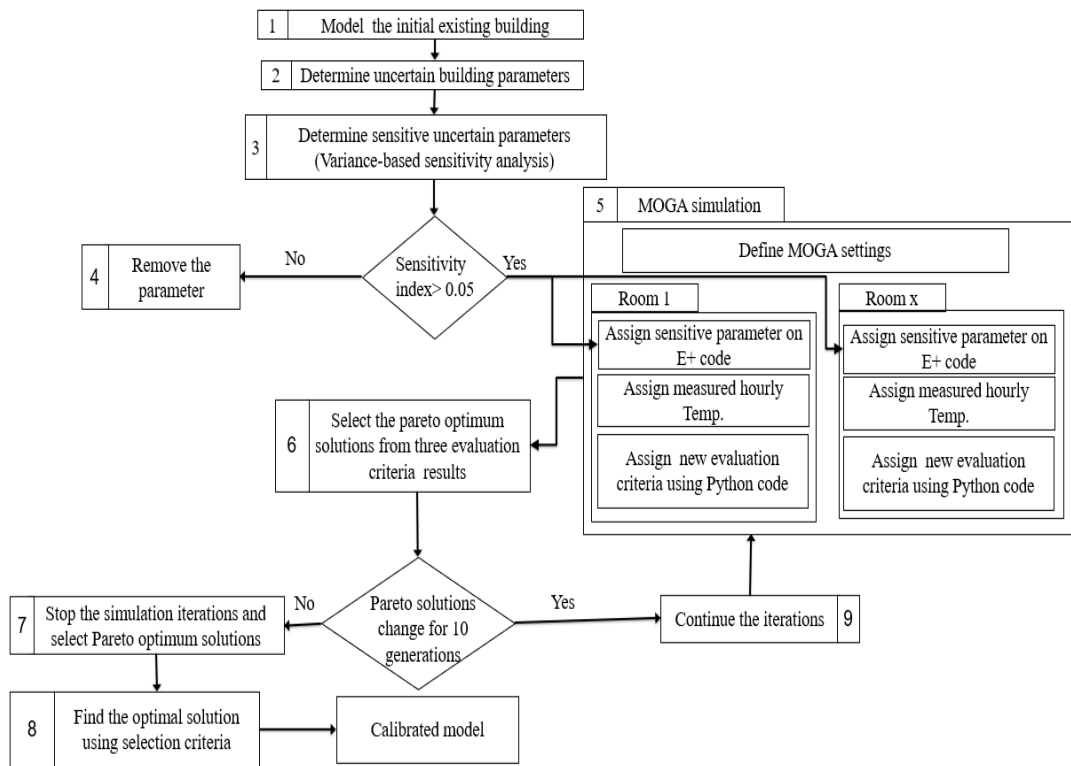

Fig.7 CALIBRATION METHOD BASED ON HOURLY INDOOR MEASURED TEMPERATURE (BABA ET AL., 2022)

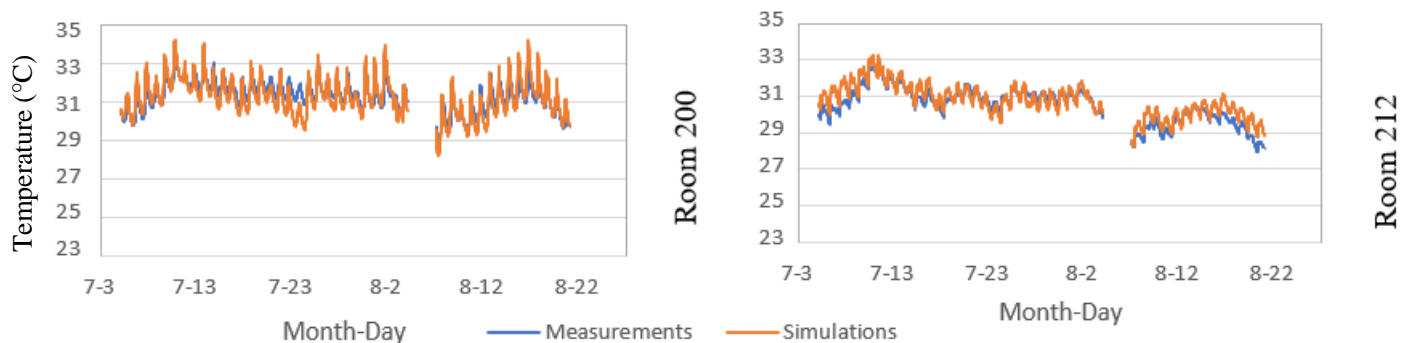

Fig.8 COMPARISON OF INDOOR AIR TEMPERATURE BETWEEN MEASUREMENTS AND SIMULATION RESULTS FROM THE CALIBRATED MODEL FOR TWO CLASSROOMS (BABA ET AL., 2022)

3. Resilient Cooling

Climate change - extreme future climate

The risk of overheating needs to be assessed for future extreme years to study the impact of climate change on indoor thermal conditions. The future climate generation and extreme future years methods adopted from "Annex80 Group Weather Data" are used. Based on the "heatwave detection operational" method, the three heatwave thresholds are 25.5 °C for Spic, 24.1 °C for Sdeb, and 23.3 °C for Sint threshold. Spic, Sdeb, and Sint are the 99.5th, 97.5th, and 95th, percentile of historical daily mean temperatures respectively (Baba, et al., 2023).

Based on these three heatwave thresholds, four heatwave events were detected in the historical period (Figure 9), 38 heatwave events in the future mid-term period (Figure 9 2041 - 2060), and 88 in the future long-term period (Figure 9 2081 - 2100). In the historical period, the extreme year (RSWY) is 2020, as it has the most intense, severe and longest heatwaves. In the future mid-term, three extreme RSWY years are selected: 2059 as it has the most intense heatwave, 2042 as it has the most severe heatwave, and 2044 as it has the longest heatwave. In the future long-term, the extreme RSWY year is 2090 as it has the longest, most intense and most severe heatwave. Therefore, the indoor thermal condition of the school is assessed in 2020 using observational weather data and in future years 2042, 2044, 2059, and 2090 using projected future weather data.

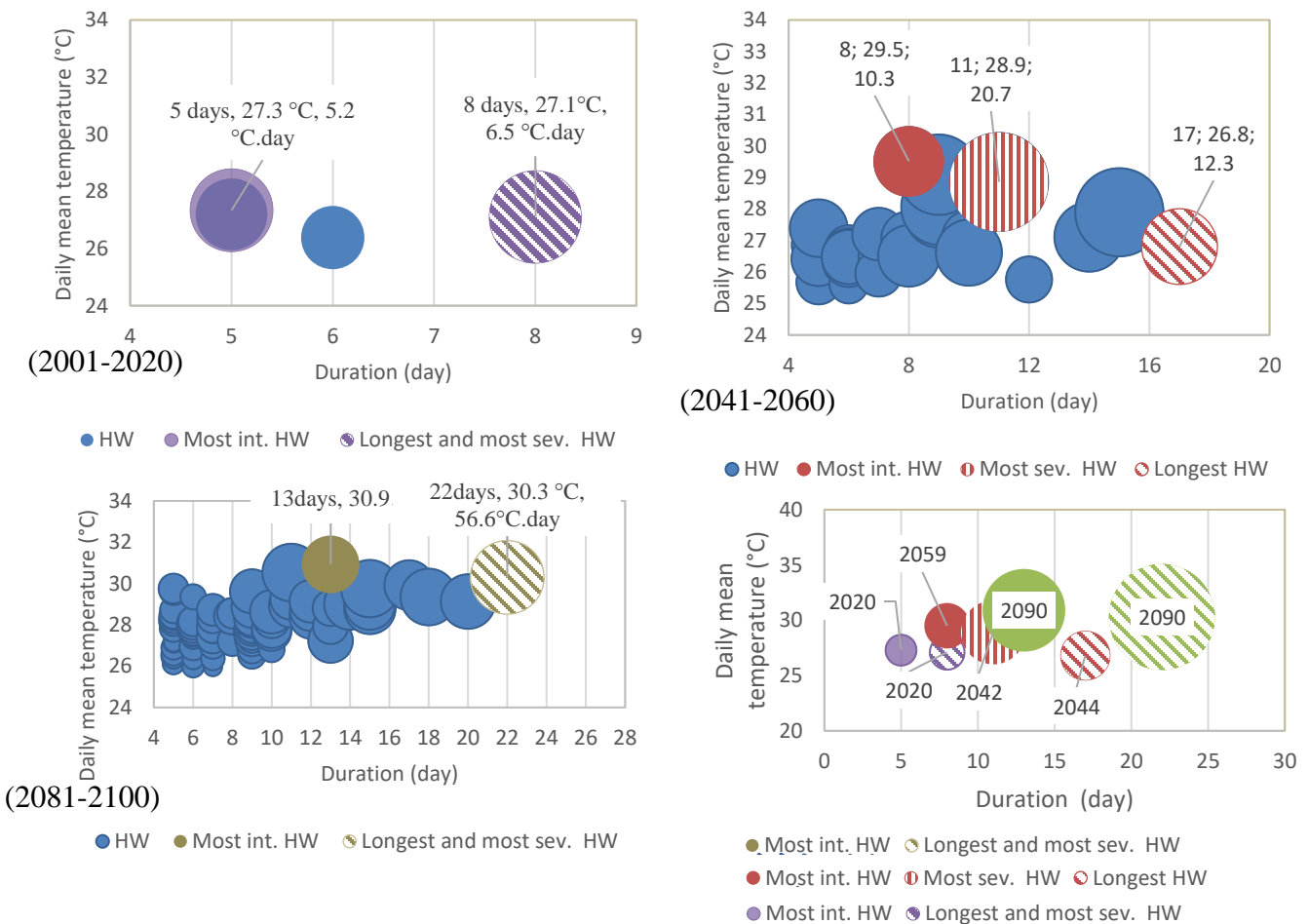

Figure.9 HEATWAVE EVENTS DURING A) HISTORICAL PERIOD, B) MID-TERM, C) LONG-TERM FUTURE PERIOD. VALUES AT THE TOP OF BUBBLES REPRESENT DURATION (DAYS), INTENSITY (°C), AND SEVERITY (°C DAY); D) EXTREME HEATWAVE EVENTS DURING THREE PERIODS (VALUE AT THE BUBBLES REPRESENTS THE YEAR IN WHICH THE HEATWAVE OCCURRED) (BABA ET AL., 2022)

3. Resilient Cooling

Design Simulation - Resilient Cooling Technology (Optimization Potential)

Resilient cooling technologies are evaluated for the years 2020, 2044, and 2090. This procedure will contribute to the development of appropriate building codes and guidelines to mitigate the expected impacts of global warming on existing buildings. Passive resilient cooling technologies that can be added to the building with minor renovation are studied to improve the operational indoor temperature without increasing the cooling consumption. These technologies are listed in Table 5. Local sensitivity analysis is used to evaluate these resilient cooling technologies and the combination of them.

Table.5 SUGGESTIONS FOR RESILIENT COOLING TECHNOLOGY

	Resilient cooling technology	Value	Description
P1	Night cooling	Opening 25% of window opening area	It is opened if the indoor temperature is higher than the outdoor temperature and higher than the ventilation setpoint (23 °C)
P2	External overhang	1.5 m	Applied to the southeast side with keeping the internal shading
P3	Blind external roll (Solar reflectance)	0.8	It is used instead of the current inside blind roll. It is activated when the solar radiation on the window surface is higher than 120 W/m ²
P4	Cool Roof-shortwave reflectivity (albedo)	0.8	The solar reflectance of the roof changes from 0.3 to 0.8
P5	Window SHGC	0.3	By using tinted window film
P6	Green Roof		The Leaf Area Index (LAI) is 5.0 and the average height of the soil is 0.1 m. The maximum volumetric moisture content of the soil layer is 0.5.-1.5

4. KPI Evaluation

4.1 Thermal Comfort KPIs

Using the calibrated and validated building simulation model, the thermal condition of the indoor environment has been evaluated according to the **Building Bulletin BB101 Guideline (BB101, 2018)** that was developed especially for schools. Three criteria shall be met during the period Monday to Friday from 09:00 am to 04:00 pm, from May 1st to September 30th, including the summer holiday period, as if the school were normally occupied. These criteria are:

- **Hours of Exceedance (HE)** **See values in Table 6**

The Hour of Exceedance (overheating hour) is the hour that its operative temperature (T_{op}) exceeds the T_{max} (the adaptive temperature threshold defined in EN 16798-1-Category I (2019)) by 1°C or more. The Hours of Exceedance must not exceed 40 occupied hours.

- **Daily Weighted Exceedance (W_e)** **See values in Table 6**

The sum of ΔT ($T_{op} - T_{max}$) that is higher than 1 °C during the day should not exceed 6 °C on any one day.

- **Upper Limit Temperature (T_{upp})** **See values in Table 6**

The operative temperature should not exceed T_{max} by 4K or more on any one day.

4.2 Heat Stress KPIs

- **Standard Effective Temperature (SET)** **See values in Table 6**

According to LEED, the Standard Effective Temperature (SET) shall not exceed 10°C SET days (240 °C SET-hours) above 30°C SET during one week

4.3 Energy

As this project relies solely on window ventilation for cooling, no energy is used onsite for space cooling. The annual cooling load is therefore zero. The building is heated by an electrical baseboard system in each room. The electric boiler is used for hot water. The COP of the heating system is 1.0. There is no electricity generated on-site.

Performance Evaluation

5. Performance Evaluation

5.1 Comfort

The four classrooms (200, 203, 208, 212) on the second floor were used as reference rooms for comfort monitoring:

- Rm. 200 and 203 classrooms: southeast orientation, useful teaching area approx. 70 m².
- Rm. 208 and 212 classrooms: northwest orientation, useful teaching area approx. 70 m².

In general, for all reference rooms, the comfort parameters during the heating period are largely in the comfortable range. However, during the cooling period, the indoor air temperature is often higher than the optimal range for classrooms (26 °C).

Table.6 OVERHEATING RISK

Measurement period: 01 May 2020 - 31 September 2020					
Reference room	Rm. 200	Rm. 203	Rm. 208	Rm. 212	
He (T > Cat. 1). Acceptance limit is 40 hrs.	110	102	48	44	hr
He (T > Cat. 2). Acceptance limit is 40 hrs.	38	35	11	10	hr
Number of days that We (Cat.1) > 6 °C/day Acceptance limit is 0 day	3	3	0	0	day
Number of days that Tupp > 4 K Acceptance limit is 0 days	0	0	0	0	day
Number of days that SET > 30 °C Acceptance limit is 0 days	2	1	0	0	°C / day

Indoor Temperature Simulation

Figure 10 & 11 show the indoor temperature of Room 200 (the hottest room) according to BB101 criteria and EN15251 categories. The orange (Cat. II) and red (Cat. I) lines delimit the range of acceptable indoor thermal conditions to evaluate Criterion 1 in BB101, the green lines show the acceptance limit for Criterion 3 (Upper Limit Temperature) in BB101.

The indoor temperature shows that the southeast classrooms have a high risk of overheating when compared to the northwest rooms, especially based on Cat. I red and orange points (Vulnerable people). Also, the cumulative excess heat in these classrooms exceeded 10 °C/day.

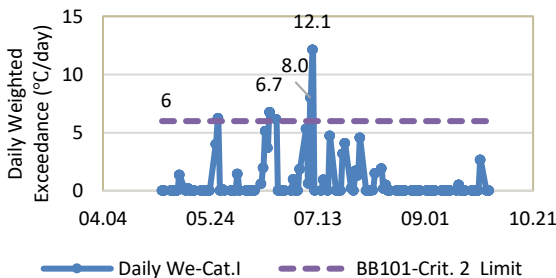

Fig.10 THERMAL CONDITION OF ROOM 200 IN 2020 BASED ON BB101 CRITERION 2 (BABA, ET AL., 2023)

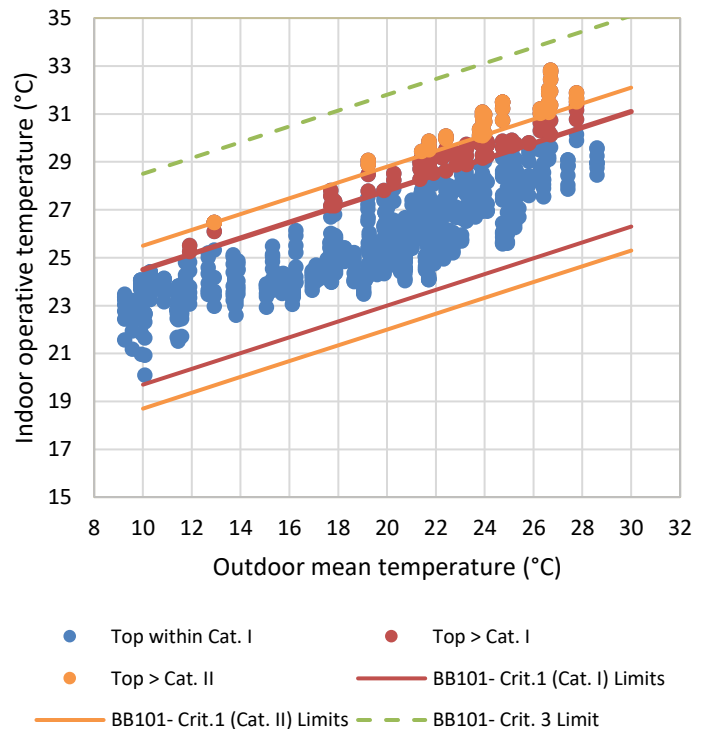

Fig.11 THERMAL CONDITION OF ROOM 200 IN 2020 BASED ON BB101 CRITERIA 1&3 LIMITS (BABA, ET AL., 2023)

Performance Evaluation

5. Performance Evaluation

Under extreme future climate

The overheating hours of all classrooms on the second floor in the years 2042, 2044 and 2059 for mid-term future climate, and 2090 for long-term future climate are calculated based on Cat. I. The results showed that the year 2044, which has the longest heatwave event, has the highest impact on indoor thermal conditions compared to the years with the most intense and severe heatwaves.

The average overheating hours are calculated based on Cat. I and II, in all the southeast and northwest rooms and the hottest classroom (room 200), as well as the increase in overheating hours in the hottest room compared to the results for 2020, as shown in Figure 12. Throughout all years, the occurrence of overheating hours, as per Category II, in southeast classrooms is three times greater than the overheating risk observed in northwest classrooms on the second floor, underscoring the considerable impact of orientation on indoor overheating risk.

All rooms, except the northwest rooms (206-212), will not have acceptable conditions in future extreme years in 2059 using Cat. II. Due to climate change, the risk of overheating in the hottest room will increase by 165 and 223 hrs. in 2044 using Cat. II and I respectively. The overheating risk will increase up to 327 hrs. in 2090 compared to the overheating risk in 2020.

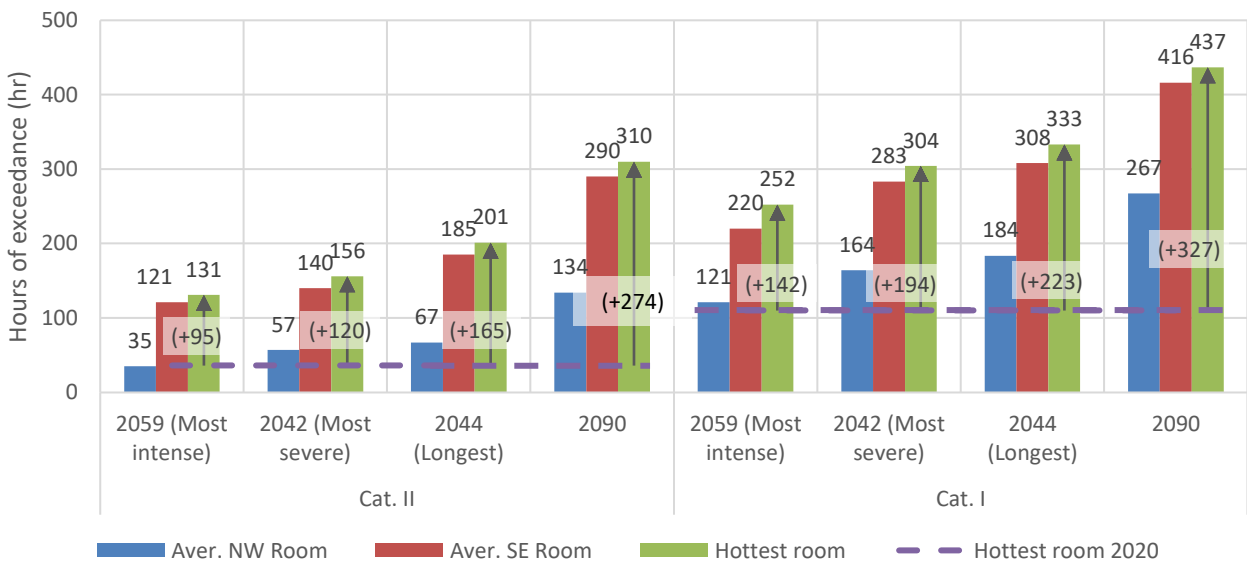

Fig. 12 OVERHEATING HOURS BASED ON BB101 CRITERION 1 (CAT. I & II THRESHOLD) UNDER FUTURE RSWY COMPARED TO OVERHEATING HOURS IN HOTTEST ROOM UNDER RECENT RSWY (BABA, ET AL., 2023)

Performance Evaluation

5. Performance Evaluation

Optimisation potential for improving indoor thermal conditions under 2020

In 2020 (Figure 13), the addition of the green roof to the original case reduces the overheating hours by 4% in the hottest classroom and a similar reduction in all other rooms. Adding the cool roof to the original case reduces overheating hours, especially for the northwest rooms where the main source of solar heat gain for these rooms is reduced. With the cool roof, overheating hours are reduced to about 20 hrs. in the northwest rooms (206-212) and to 79 hrs. (-28%) in the hottest room. The use of night cooling, overhang shading, and SHGC reduction significantly reduce the overheating hours in the hottest room to 44, 40, and 37 hrs., respectively, and almost meet the BB101 requirement for all rooms. The use of exterior screen shading (blind roll) can be the best solution to mitigate overheating, reducing overheating hours to 16 hrs in the hottest room and almost 0 hrs in the north rooms.

The effect of a combination of night cooling (NC) and cool roof (CR), overhanging shading (OH) or lower SHGC on the indoor thermal condition has also been studied. The results show that the overheating hours were reduced to 32 hrs by using night cooling and a cool roof, 24 hrs. by using night cooling and overhang shading, and 18 hrs. by using night cooling and lower SHGC in the hottest classroom. These mitigation measures can achieve BB101 Criteria 2 (daily weighted exceedance).

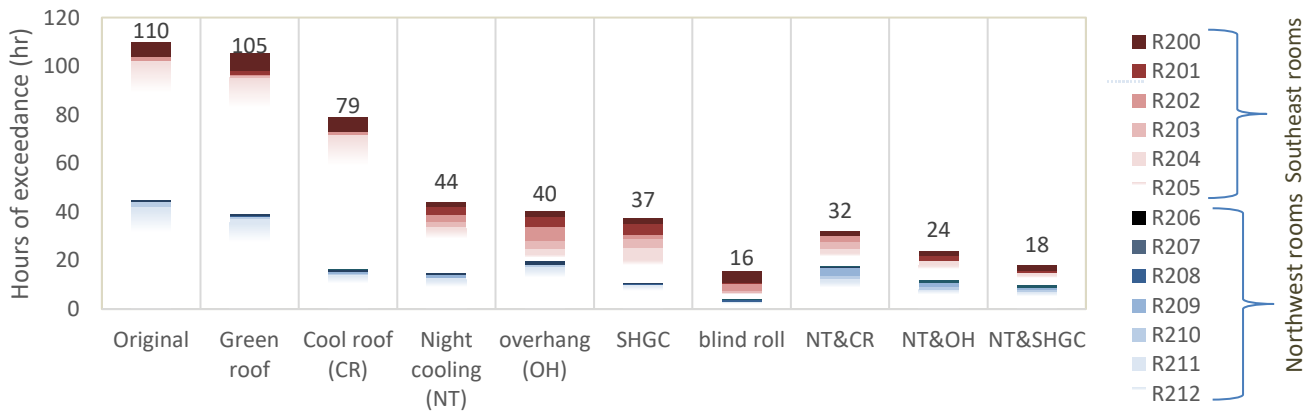

Fig.13 THERMAL CONDITION OF ROOM 200 IN 2020 WITH VARIOUS SUGGESTIONS FOR MITIGATION MEASURES (BABA, ET AL., 2022)

5. Performance Evaluation

Optimization potentials for improving indoor thermal conditions under future years

Under 2044, blind shading will be able to reduce the overheating hours from 330 hrs. (red dots in Figure 14a) to 100 hrs (purple dots in Figure 14a), which is still above the requirements of BB101. Therefore, the addition of night cooling to blind shading can reduce the overheating hours to 15 hrs. (orange dots in Figure 14a) in the hottest room based on Cat. I and can achieve BB101 Criteria 2 (daily weighted exceedance).

In 2090, the combination of blind roll and night cooling will reduce the overheating hours to 84 hrs. based on Cat. I, as shown in Figure 14b. Therefore, the cool roof measures are applied with blind roll and night cooling. This combination will be able to reduce the overheating hours based on Cat. I to 39 hrs in the hottest room and can achieve BB101 Criteria 2.

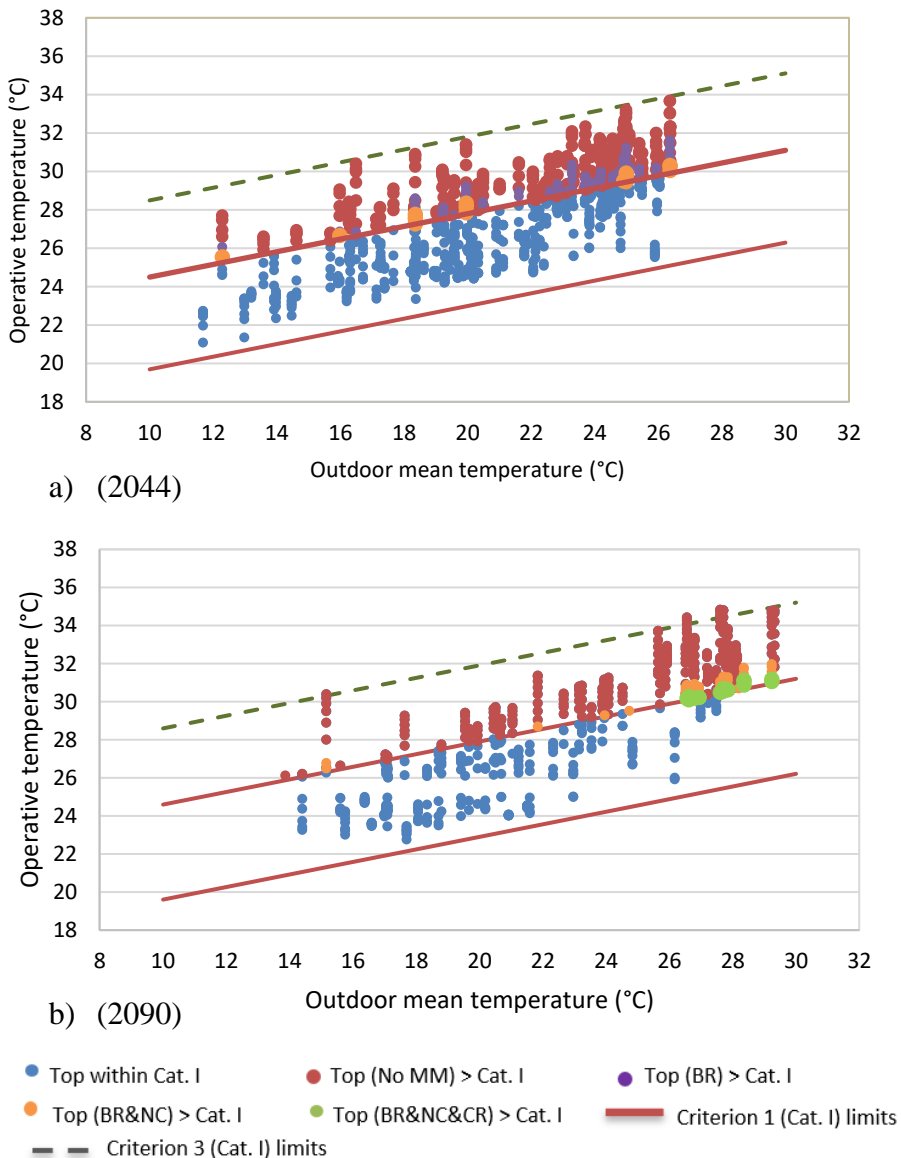

FIG.14 INDOOR OPERATIVE TEMPERATURE WITH VARIOUS MITIGATION MEASURES IN ROOM 200 DURING SUMMER 2020, 2044 AND 2090 (BABA, ET AL., 2023)

5. Performance Evaluation

5.2 Energy consumption for heating

The total heat consumption for the period January 2020 - December 2020 is around 150,000 kWh.

The simulated specific heating energy consumption is 95 kWh/m²a. The building is heated exclusively by hot water radiators. Figure 15 below shows the monthly electricity use structure.

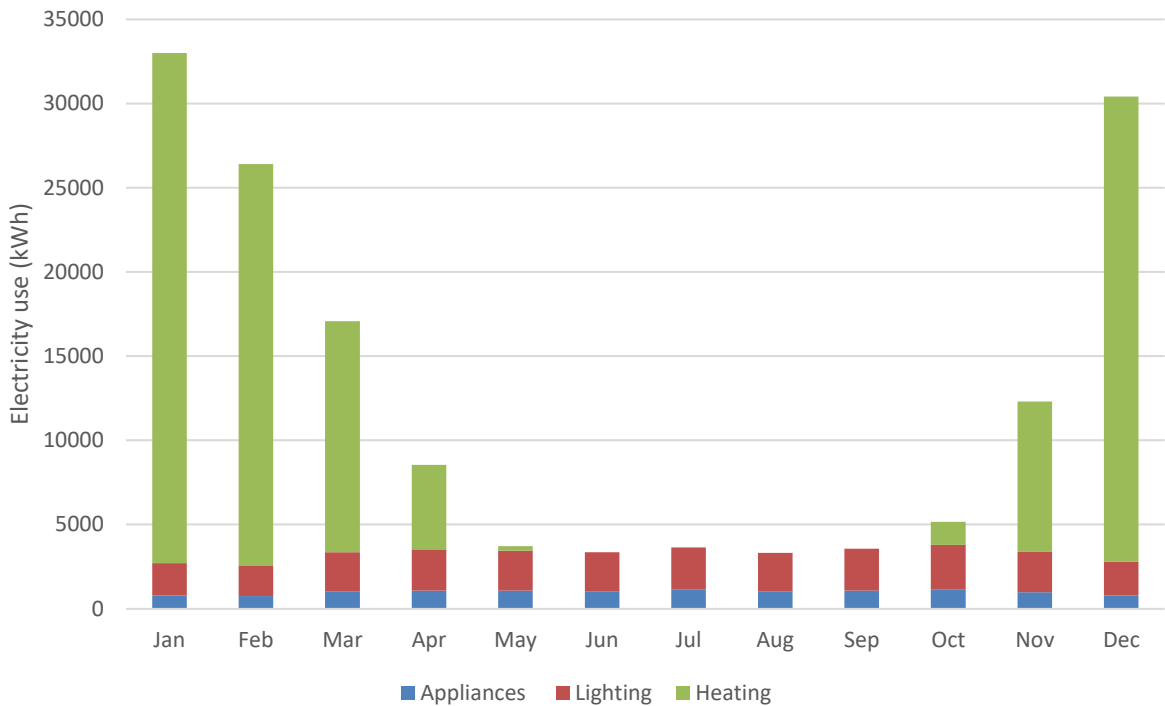

Fig.15 MONTHLY ENERGY USE, GRANDS-ÊTRES SCHOOL

6. Discussion, Lessons Learned

6.1 Summary

The Sainte Antoine school was built in 1958 and offers space for classrooms, meeting rooms, and gyms. It was built according to the energy requirements of the time with heavy construction and building envelope. Four classrooms located on the second were selected to measure the indoor thermal conditions.

To evaluate the indoor thermal condition of the school building using the BB101 requirement, the indoor thermal condition must be evaluated during the whole summer (May 1 to September 30) building as if the school was normally occupied. Therefore, the measured indoor temperature data is used to validate the simulated indoor temperature. As many building parameters are uncertain in this case, a novel calibration method (Baba et al., 2022) is used to make the simulated indoor air temperature of the model reflect the measured indoor temperature.

The overheating risk must be assessed for the future extreme years to study the impact of climate change on indoor thermal conditions. The future climate generation and extreme future years methods adopted from "Annex80 Group Weather Data" are used.

Resilient cooling technologies are evaluated for 2020, 2044, and 2090. Passive resilient cooling technologies that can be added to the building with minor renovation are studied to improve the operative indoor temperature without increasing the cooling consumption.

6.2 Optimisation potential

Optimizing indoor comfort in summer

- Despite the availability of natural ventilation and internal shading, there are more than 110 overheating hours in the summer of 2020, especially in the classrooms located on the southeast side. Also, the indoor daily weighted exceedance in the hottest classroom reached 12 °C/day, exceeding the requirements of the BB101 guide.
- The use of exterior blind roll (screen shading) or a combination of night cooling and other mitigation measures to reduce solar heat gain (such as cool roof, exterior overhang, lower window SHGC) can achieve acceptable thermal conditions by reducing the overheating hours from 110 to 16 hrs. and the indoor daily weighted temperature from 12 to 6°C/day.
- The number of heatwaves will increase from four heatwaves in the historical period (2001-2020) to 38 heatwaves in the mid-term (2041-2060) and to 88 in the long-term (2081-2100) future years. Using the operational method of heatwave detection, the year 2020 was the hottest in the historical period and 2044 and 2090 will be the hottest years in mid and long-term future periods, respectively. The risk of overheating in the hottest classroom with the current operating situation will increase to 333 hrs. and 437 hrs. in 2044 and 2090, respectively, if no mitigation measures are applied.
- The use of the night cooling combined with the exterior blind roll reduces the overheating hours to 15 hrs. in 2044, but in 2090 additional measures such as the addition of a cool roof should be considered, which can reduce the overheating hours to 39 hrs., which would be within the acceptable limit (40 hrs.).

References & Key Contacts

7. References & Key Contacts

7.1 References

ASHRAE, ANSI/ASHRAE Standard 169-2013, Climatic Data for Building Design. Atlanta: ASHRAE, 2013.

Baba, F. M., Ge, H., Wang, L. L., & Zmeureanu, R. (2023). Assessing and mitigating overheating risk in existing Canadian school buildings under extreme current and future climates. *Energy and Buildings*, 279, 112710.

Baba, F. M., Ge, H., Zmeureanu, R., & Wang, L. L. (2022). Calibration of building model based on indoor temperature for overheating assessment using genetic algorithm: Methodology, evaluation criteria, and case study. *Building and Environment*, 207, 108518.

Baba, F. M., Ge, H., Wang, L. L., & Zmeureanu, R. (2022). Do high energy-efficient buildings increase overheating risk in cold climates? Causes and mitigation measures required under recent and future climates. *Building and Environment*, 219, 109230.

Zhang, C., Kazanci, O. B., Attia, S., Levinson, R., Lee, S. H., Holzer, P., ... & Heiselberg, P. (2023). IEA EBC Annex 80-Dynamic simulation guideline for the performance testing of resilient cooling strategies: Version 2.

Baba, F. M., Ge, H., Zmeureanu, R., & Wang, L. L. (2023). Optimizing overheating, lighting, and heating energy performances in Canadian school for climate change adaptation: Sensitivity analysis and multi-objective optimization methodology. *Building and Environment*, 110336.

BB101. (2018). Building Bulletin 101: Guidelines on ventilation, thermal comfort and indoor air quality. Department for Education and Skills (DfES). London

7.2 Contacts

Company	Role	Contact
British University in Dubai	Assistant professor	Fuad Baba Fuad.Baba@buid.ac.ar

1. Introduction & Climate

1.1 Introduction

The building was built in two different periods. Block 1 was built in 1990, and Block 2 in 1950 with old energy requirements. The building envelope construction was steel with brick veneer external wall, block partitions, concrete roof with insulation, and two-layer single-glazed windows. The building was built in 1950 and offers space for classrooms, meeting rooms, and gyms. The building has a gross floor area of around 2825 m², with 2 Blocks. The residents are kids aged 5-10 years.

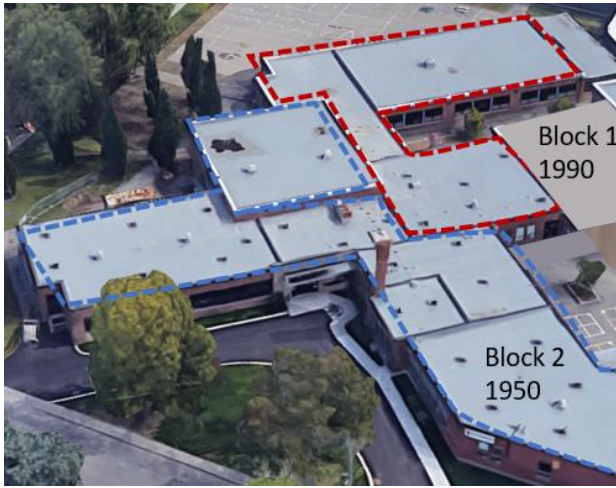

Fig.1 EXTERIOR VIEW, SOUTHEAST VIEW, SCHOOL PROJECT MONTREAL

1.2 Local Climate

Location: The building is located in the Saint-Laurent district of Montreal. In 1150 Rue Deguire (45.521 °N, 73.685 °W).

Climate Zone: 6A (ASHRAE), DFA (Historical KOPPEN-GEIGER MAP), AND DFB (Future KOPPEN-GEIGER MAP)

Climate Zone	Description
EA	Extremely Hot Humid
EB	Extremely Hot Dry
1A	Very Hot Humid
1B	Very Hot Dry
2A	Hot Humid
2B	Hot Dry
3A	Warm Humid
3B	Warm Dry
3C	Warm Marine
4A	Mixed Humid
4B	Mixed Dry
4C	Mixed Marine
5A	Cool Humid
5B	Cool Dry
5C	Cool Marine
6A	Cold Humid
6B	Cold Dry
7	Very Cold
8	Subarctic

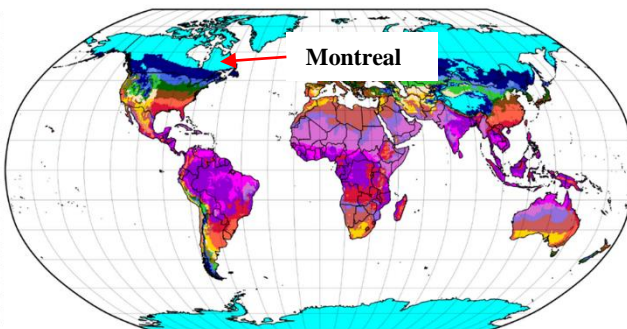

Fig.2 CLIMATE MAP (ASHRAE 169 - CLIMATE DATA FOR BUILDING DESIGN STANDARDS)

Table.1 KEY INFORMATION ABOUT THE BUILDING

Location	Montreal, Canada
Building Type	School
Retrofit (Y/N)	N
Surroundings (Urban/Rural)	Urban
Year of Completion	1950, 1990
Floor Area (m²)	2825
Shape	U shape
Openable Area to Floor Area Ratio (%)	22%
Window to Wall Ratio (%)	50%
Climate Zone	6A
Heating Degree days 12/20 (Kd)	3446

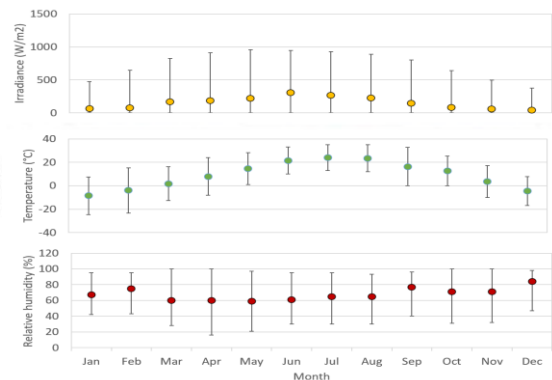

Fig. 3 MEAN, MAXIMUM AND MINIMUM EXTERNAL CONDITIONS IN MONTREAL USING MEASURED DATA

2. Building

2.1 Envelope and Construction

The building is a school property with classroom space. It was completed in 1950 (Block 2) and 1990 (Block 1).

Special features of the building envelope and construction

- Solid construction built to the lowest energy efficiency standard, 1 story
- One main body of solid construction
- Steel skeleton with curtain-type block and brick façade
- Box-type double windows, single glazed
- No exterior solar protections installed, interior blind roll shading is used
- No cooling system
- Windows can be opened 25% at a time

Table.2 INFORMATION PLANNING, OPERATION AND USE

Information on planning, operation and use

Object use	Classrooms
Integral planning process	Quebec government, as the owner, actively managed the planning process.
Technical management	Own operational management through self-organisation of the residents with the support of external maintenance companies
Energy monitoring	There are interior temperature sensors in five classrooms and an exterior weather station on the roof of the building.

Table.3 BUILDING PROPERTIES

Property	Unit	Value	
		Block 1	Block 2
Hours of occupancy	h/week	40	40
Window U-value	W/(m ² K)	2.4	1.8
Window g-value	-	0.65	0.57
Wall U-value	W/(m ² K)	0.40	0.30
Roof U-value	W/(m ² K)	0.23	0.20
Floor U-value	W/(m ² K)	0.24	0.20
Window to Wall Ratio	%	50	50
Air-tightness (@50 Pa)	1/h	5.0	2.5

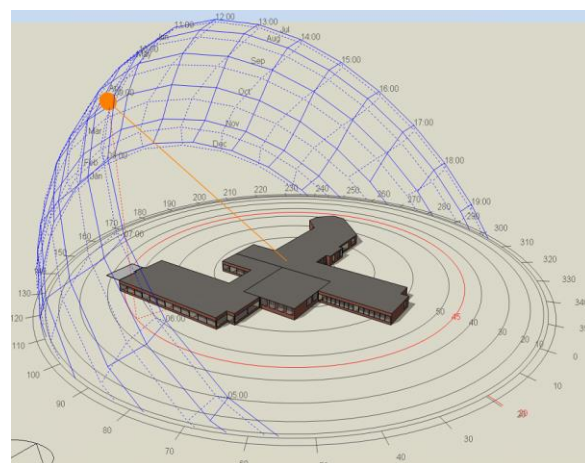

Fig. 4 VOLUMETRIC MODEL (GRANDS-ÊTRES SCHOOL)

2. Building

2.2 Energy Systems

Schematic design of Energy System

A hot water baseboard system is used for heating. Electricity is supplied by a municipal grid system. The electric boiler is used for hot water. Cooling is provided by using natural ventilation by opening exterior and interior windows.

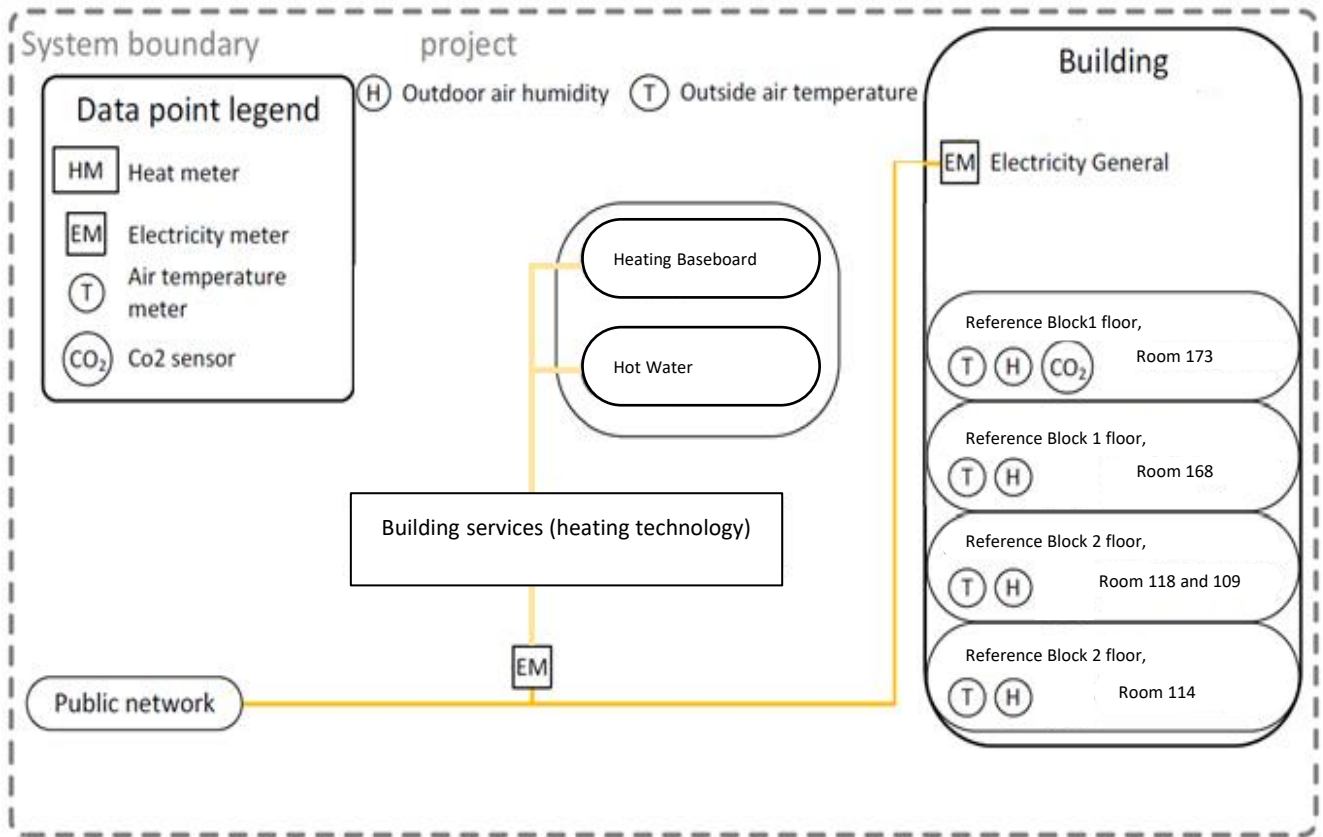

Fig.5 SCHEMATIC DIAGRAM OF THE, GRANDS-ÊTRES SCHOOL BUILDING TECHNOLOGY AND MEASUREMENT CONCEPT

Description of Energy System

Heating System

The building is heated by an electric baseboard system in each room heating. The electrical boiler is used for hot water.

Cooling System

The building is cooled by natural ventilation. Exterior windows primarily provide natural ventilation by opening 30% of the total window area. Based on the measured data, occupants open windows when the indoor temperature reaches 23 °C in the southeast classrooms and 24 °C in the northwest classrooms.

Electrical Power Supply

Electricity is supplied by the public grid. The electricity demand is made up of the electricity demand of the occupants and the electricity demand of the building services.

Energy System

2. Building

Indoor thermal conditions measured

Five classrooms on the first floor (i.e., rooms 109, 114, 118, 168 and 173), as shown in Figure 6, were selected according to different orientations for comparison purposes to measure the indoor thermal conditions.

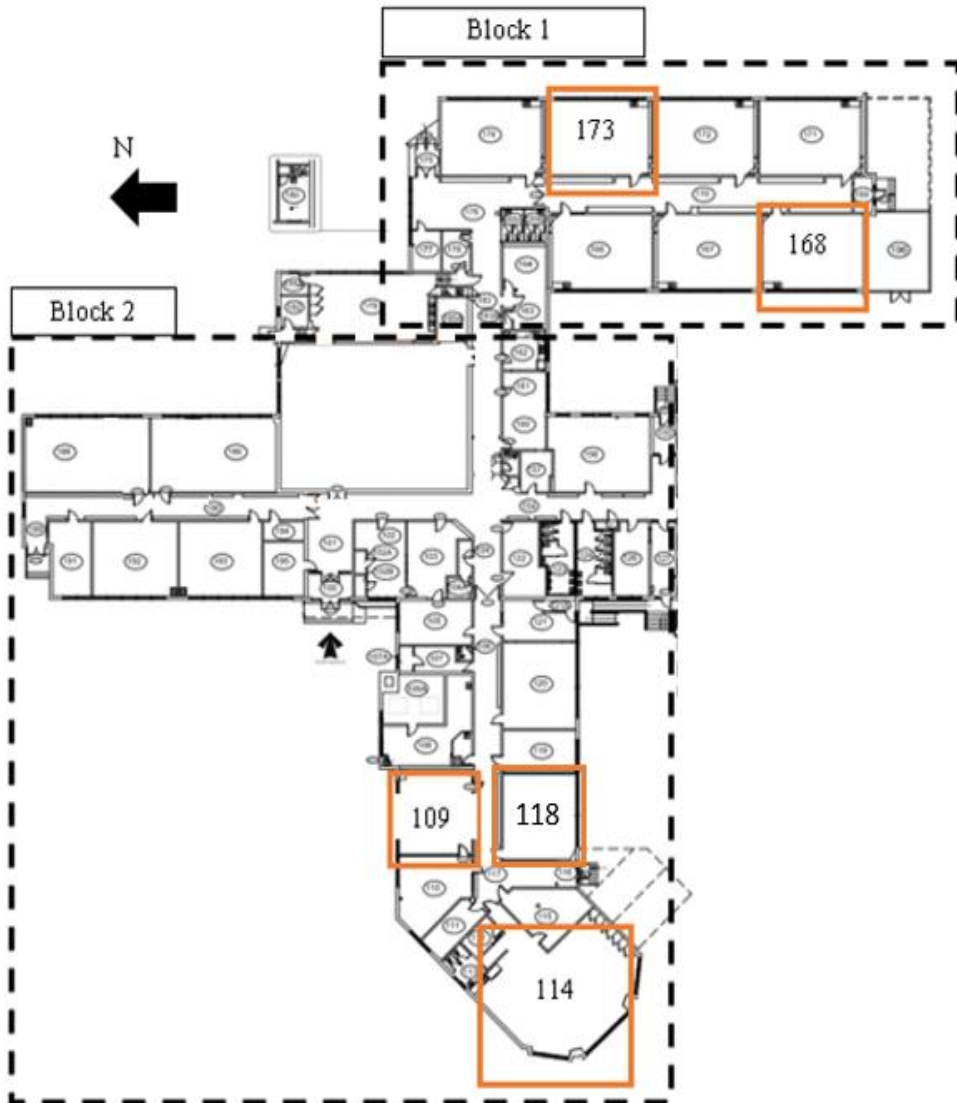

Fig.6 FIRST-FLOOR PLAN OF THE SAINT GRANDS-ÊTRES SCHOOL WITH THE IDENTIFICATION OF THE FIVE ROOMS THAT CONTAIN INTERNAL TEMPERATURE, RH AND CO₂ SENSORS

Resilient Cooling

3. Resilient Cooling

3.1 Principles

In principle, all windows have internal shading (blind roll shading with a 0.7 solar reflectance). The building structure is made of concrete for thermal mass utilization.

Also, the rooms are cooled by introducing natural ventilation by windows.

No mechanical cooling or ventilation is used in the building.

3.2 Structure of resilient cooling technology

I REDUCE EXTERNAL HEAT GAIN

Interior Shading

Blind roll shading is used to reduce the external heat gain through the windows.

II REMOVING HEAT FROM INDOOR ENVIRONMENT

Ventilation System

Ventilation: Cool air can be brought into the building by opening the exterior windows. These windows are also responsible for extracting the exhaust air from the room. The internal windows and doors provide cross-ventilation between rooms. The extracted air is then returned to the outside via the extract air duct as exhaust air.

Thermal Mass:

The building is constructed using block and brick. It is responsible for absorbing heat during the day and releasing it during the night.

Table.4 STRUCTURE OF THE SYSTEM

1. Reducing Heat Loads to People and Indoor Environments	
1.1. Solar Shading Technologies	
1.2. Cool Envelope Materials	
1.3. Glazing Technologies	
1.4. Ventilated Façades	
1.5. Green Roofs and Green Façades	
2. Reducing Heat Loads to People and Indoor Environments (Production, Emission and combined)	
2.1. Ventilative cooling	
2.2. Thermal Mass Utilization	
2.3. Evaporative Cooling	
2.4. Sky Radiative Cooling	
2.5. Compression Refrigeration	
2.6. Adsorption Chiller	
2.7. Natural Heat Sinks	
2.8. Radiant Cooling	
3. Increasing Personal Comfort Apart from Space Cooling	
3.1. Comfort Ventilation and Elevated Air Movement	
3.2. Micro-cooling and Personal Comfort Control	
4. Removing Latent Heat from Indoor Environments	
4.1. Dehumidification	



Fig.7 PHOTOS OF EXTERIOR WINDOWS WITH INTERIOR SHADING IN BLOCK 1 (LEFT), AND IN BLOCK 2 (RIGHT)

3. Resilient Cooling

3.3 Design simulation

To evaluate the indoor thermal condition of the school building under different scenarios, the validated Building Simulation Model (BSM) based the measured indoor air temperature must be used. Since many building parameters are uncertain in this case, these parameters must first be calibrated so that the indoor air temperature prediction from the BSM reflects the measured indoor air temperature. In order to achieve this, a novel calibration methodology shown in Figure 8 (Baba et al., 2022) is used. The results presented in Figure 9 shown that the calibrated BSM achieves a high level of accuracy as indicated by the Root Mean Square Error (RMSE) of less than 0.8 °C, the Normalised Mean Bias Error (NMBE) of less than 1%, the Maximum Absolute Difference (Baba et al., 2022) of less than 2.5 °C, and the 1 °C Percentage Error Criteria (Baba et al., 2022) of less than 13%.

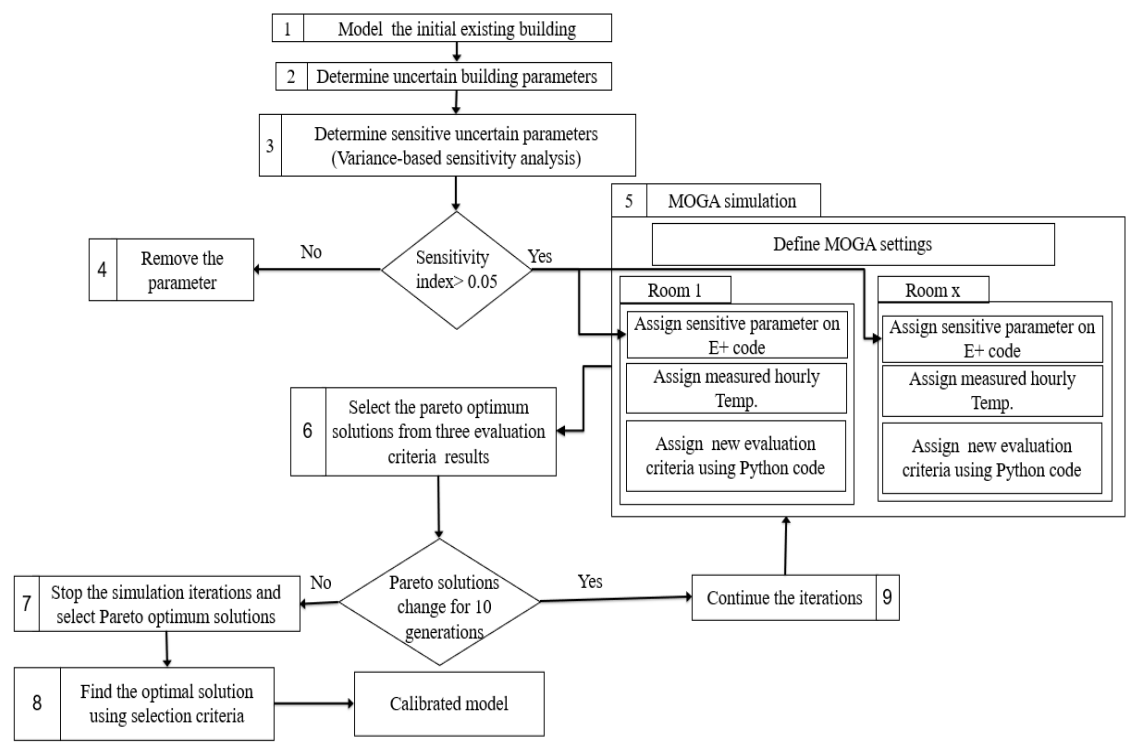

Fig.8 CALIBRATION METHOD BASED ON HOURLY INDOOR MEASURED TEMPERATURE (BABA ET AL., 2022)

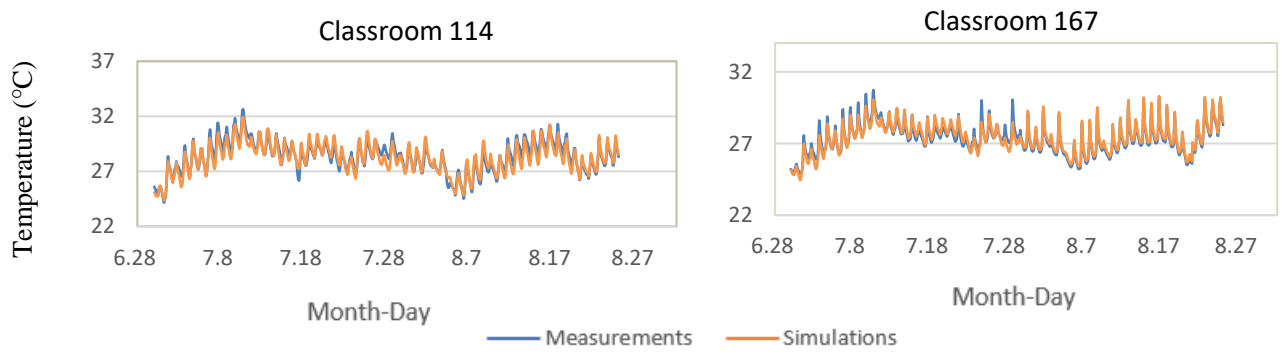

Fig.9 COMPARISON OF INDOOR AIR TEMPERATURE BETWEEN MEASUREMENTS AND SIMULATION RESULTS FROM THE CALIBRATED MODEL FOR TWO CLASSROOMS (BABA ET AL., 2022)

3. Resilient Cooling

Climate change- extreme future climate

The risk of overheating needs to be assessed under future extreme years to study the impact of climate change on indoor thermal conditions. The future climate generation and extreme future years methods adopted from "Annex80 Group Weather Data" are used. Based on the "heatwave detection operational" method, the three heatwave thresholds are 25.5 °C for Spic, 24.1 °C for Sdeb, and 23.3 °C for Sint threshold.

Based on these three heatwave thresholds, four heatwave events were detected in the historical period (Figure 9), 38 heatwave events in the future mid-term period (Figure 9 2041 - 2060), and 88 in the future long-term period (Figure 9 2081 - 2100). In the historical period, the extreme year (RSWY) is 2020, as it has the most intense, severe and longest heatwaves. In the future mid-term, three extreme RSWY years are selected: 2059 as it has the most intense heatwave, 2042 as it has the most severe heatwave, and 2044 as it has the longest heatwave. In the future long-term, the extreme RSWY year is 2090 as it has the longest, most intense and most severe heatwave. Therefore, the indoor thermal condition of the school is assessed in 2020 using observational weather data and in future years 2042, 2044, 2059, and 2090 using projected future weather data.

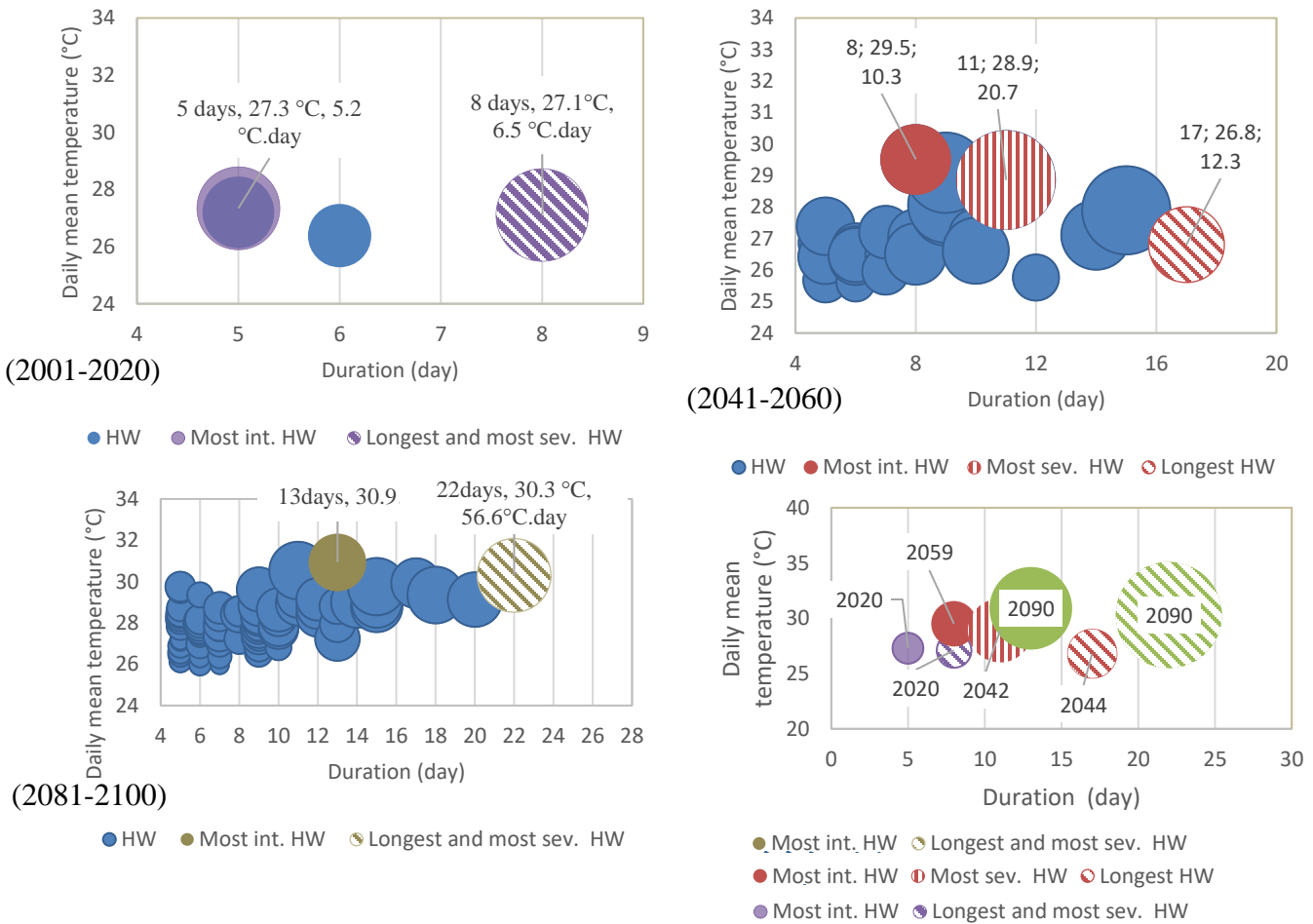

Figure 10. HEATWAVE EVENTS DURING A) HISTORICAL PERIOD, B) MID-TERM, C) LONG-TERM FUTURE PERIOD. VALUES AT THE TOP OF BUBBLES REPRESENT DURATION (DAYS), INTENSITY (°C), AND SEVERITY (°C/DAY); D) EXTREME HEATWAVE EVENTS DURING THREE PERIODS (VALUE AT THE BUBBLES REPRESENTS THE YEAR IN WHICH THE HEATWAVE OCCURRED) (BABA ET AL., 2022)

3. Resilient Cooling

Design simulation- Resilient cooling technology (Optimization Potential)

Resilient cooling technologies are evaluated under 2020, 2044, and 2090. This procedure will contribute to the development of appropriate building codes and guidelines to mitigate the expected impacts of global warming on existing buildings. Passive resilient cooling technologies that can be added to the building with minor renovation are studied to improve indoor operative temperature without increasing cooling consumption. These technologies are listed in Table 5. Local sensitivity analysis is used to evaluate this Resilient cooling technology and the combination between them.

Table.5 SUGGESTIONS FOR RESILIENT COOLING TECHNOLOGY

	Resilient cooling technology	Value	Description
P1	Night cooling	Opening 25% of window opening area	It is opened if the indoor temperature is higher than the outdoor temperature and higher than the ventilation setpoint (23 °C)
P2	Exterior overhang	1.5 m	Applied to the southeast side with keeping the internal shading
P3	Blind exterior roll (Solar reflectance)	0.8	It is used instead of the current inside blind roll. It is activated when the solar on the window surface is higher than 120 W/m ²
P4	Cool Roof-shortwave reflectivity (albedo)	0.8	The solar reflectance of the roof changes from 0.3 to 0.8
P5	Window SHGC	0.3	By using Dark Shading window Tinted film
P6	Green Roof		The leaf area index (LAI) of 5.0 and the average height of the soil is 0.1 m. The maximum volumetric moisture content of the soil layer is 0.5.0-1.5

4. KPI Evaluation

4.1 Thermal Comfort KPIs

Using the calibrated and validated building simulation model, the thermal condition of the indoor environment has been evaluated according to **Building Bulletin BB101 Guideline** that was developed especially for schools. Three criteria shall be met during the period Monday to Friday from 09:00 AM to 04:00 PM, from May 1 to September 30, including the summer holiday period as if the school is occupied normally. These criteria are:

- **Hours of exceedance (HE)**

See values in Table 6

The Hour of exceedance (overheating hour) is the hour that its operative temperature (T_{op}) exceeds the T_{max} (The adaptive temperature threshold determined by EN 16798-1-Category I (2019)) by 1°C or more. The Hours of exceedance must not exceed 40 occupied hours.

- **Daily Weighted Exceedance (We)**

See values in Table 6

Sum of ΔT ($T_{operative} - T_{max}$) that is higher than 1°C during the day should not exceed 6 °C on any one day.

4.2 Energy

As this project relies solely on cooling via window ventilation, no energy is used onsite for space cooling. The annual cooling load is therefore zero.

The building is heated by an electrical baseboard system in each room. The electric boiler is used for hot water. The COP of the heating system is 1.0.

No electricity is generated on site.

Performance Evaluation

5. Performance Evaluation

5.1 Comfort

Five classrooms (Rm) on the second floor were used as reference rooms for comfort monitoring:

- Rm. 109: North orientation, useful teaching area approx. 60 m².
- Rm. 114: Southeast orientation, useful teaching area approx. 150 m².
- Rm. 118: South orientation, useful teaching area approx. 60 m².
- Rm. 168: West orientation, useful teaching area approx. 80 m².
- Rm. 172: East orientation, useful teaching area approx. 80 m².

In general, for all reference rooms, the comfort parameters during the heating period are largely in the comfortable range. However, during the cooling period, the indoor air temperature is often higher than the optimal range for classrooms (26 °C).

Table.6 OVERHEATING RISK

Simulation period: 01 May 2020 - 31 September 2020					
Reference room	Rm. 109	Rm. 114	Rm. 118	Rm. 168	Rm. 172
He (T > Cat. 1). Acceptance limit is 40 hrs.	60	100	130	50	70
He (T > Cat. 2). Acceptance limit is 40 hrs.	0	5	8	0	2
Number of days that We(Cat.1) > 6 °C/day Acceptance limit is 0 days	0	0	0	0	0

Indoor Temperature Simulation

Figures 11 & 12 show the indoor temperature of Rm. 118 (the hottest room) according to BB101 criteria and EN15251 categories. The red (Cat. I) lines define the range of acceptable indoor thermal conditions to evaluate Criterion 1 in BB101, and the gray lines show the acceptance limit for Criterion 3 (Upper Limit Temperature) in BB101.

The indoor temperature shows that the south classrooms have a high risk of overheating when compared to the north, east, and west rooms. Also, the cumulative excess heat in those classrooms reached more than 10 °C/day.

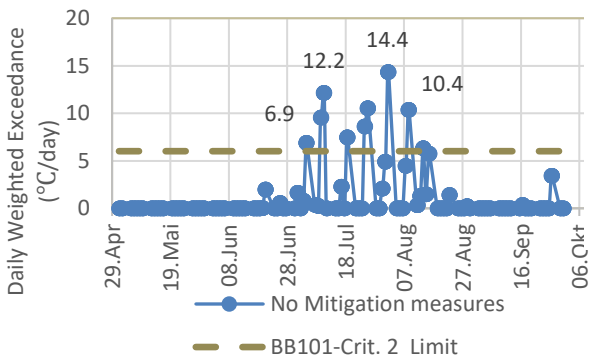

Fig.11 THERMAL CONDITION OF ROOM 118 UNDER 2020 BASED ON BB101 CRITERION 2

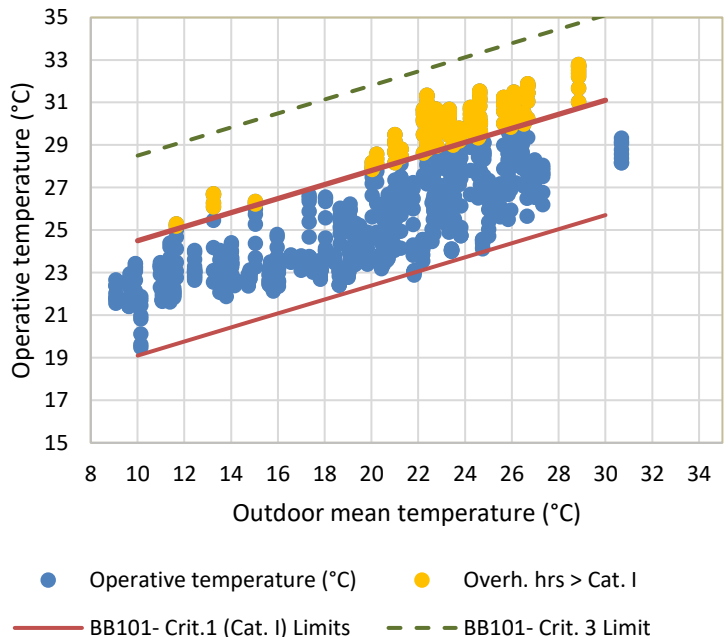

Fig.12 THERMAL CONDITION OF ROOM 118 UNDER 2020 BASED ON BB101 CRITERIA 1&3 LIMITS

5. Performance Evaluation

Under extreme future climate

The overheating hours of all classrooms in Blocks 1 and 2 under 2020, 2044 for mid-term future climate, and 2090 for long-term future climate are calculated based on Cat. I.

Under 2044, the overheating hours in the average west and east classrooms in Block 1 and Block 2 are 115 and 223 hrs. respectively, confirming that the indoor thermal condition in the new block (BL 1) is better than the one in the old block (BL 2). The overheating hours in the average north and south classrooms in Block 2 are 170 and 238 hrs. respectively. The overheating hours in the hottest classroom in Block 1 and Block 2 are 126 and 251 hrs. respectively.

The risk of overheating will increase up to 320 hrs. in the hottest room in 2090.

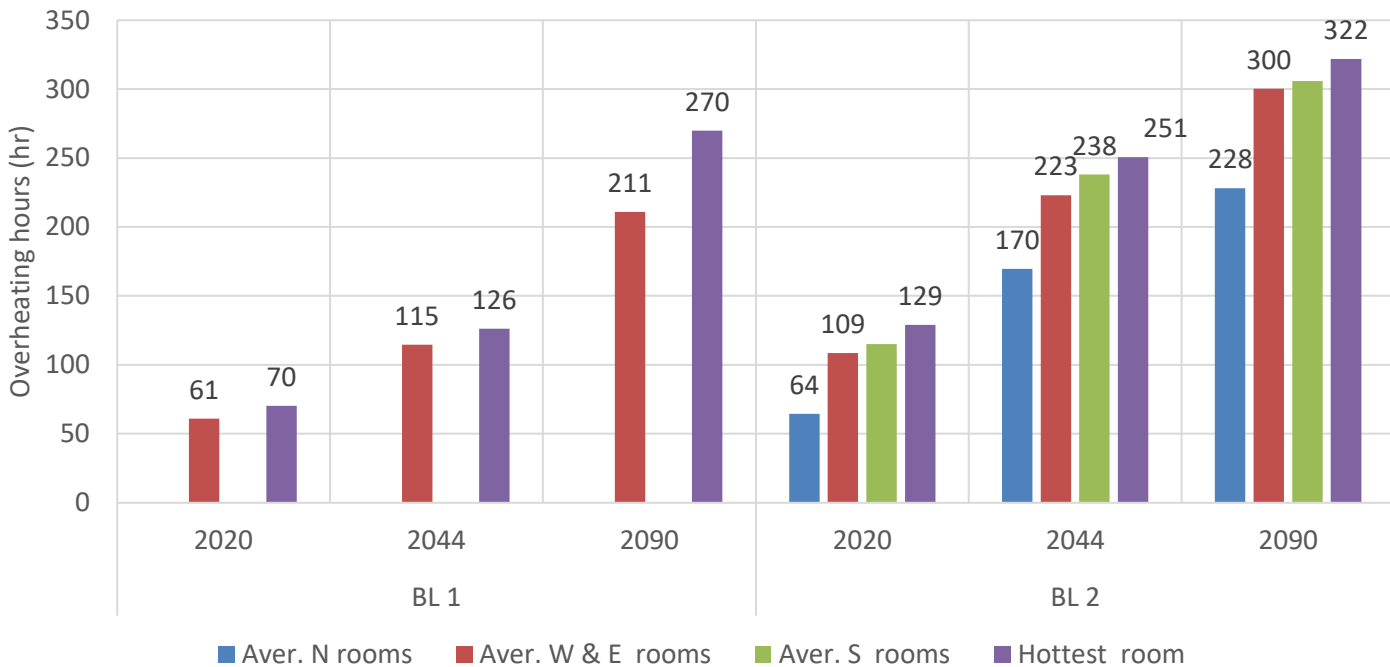

Fig. 13 OVERHEATING HOURS BASED ON BB101 CRITERION 1 (CAT. I) UNDER CURRENT AND FUTURE RSWY YEARS

Performance Evaluation

5. Performance Evaluation

Optimisation potentials for improving indoor thermal conditions under 2020

Under 2020 (Figure 14), the addition of the green roof to the original case reduces the overheating hours by 18% (from 138 hrs. to 113 hrs.) in the hottest classroom and a similar reduction in all other rooms. Adding a cool roof to the original case reduces overheating hours. With the cool roof, the overheating hours in the west and east rooms in Block 1 and the north rooms in Block 2 are reduced to around 20 hrs., while in the hottest room they are reduced to 73 hrs. (-47%). Night cooling, overhang shading, and SHGC reduced the overheating hours in the south rooms significantly to 69, 48, and 49 hrs., respectively. The use of overhang shading or low SHGC measures can be sufficient to meet the BB101 requirement for all rooms except the south rooms in Block 2. The use of exterior screen shading (blind roll) can be the best solution to mitigate overheating, as it reduces the overheating hours to 32 hrs. in the south rooms and almost 0 hrs. in the west and east rooms in Block 1 and the north rooms in Block 2. The effect of a combination between night cooling (NC) and cool roof (CR), overhanging shading (OH) or lower SHGC on the indoor thermal condition has also been studied. The results show that the overheating hours were reduced to 25 hrs. by using night cooling and a cool roof, 35 hrs. by using night cooling and overhang shading, and 32 hrs. by using night cooling and lower SHGC in the south classrooms. These mitigation measures can achieve BB101 criteria 2 (daily weighted exceedance).

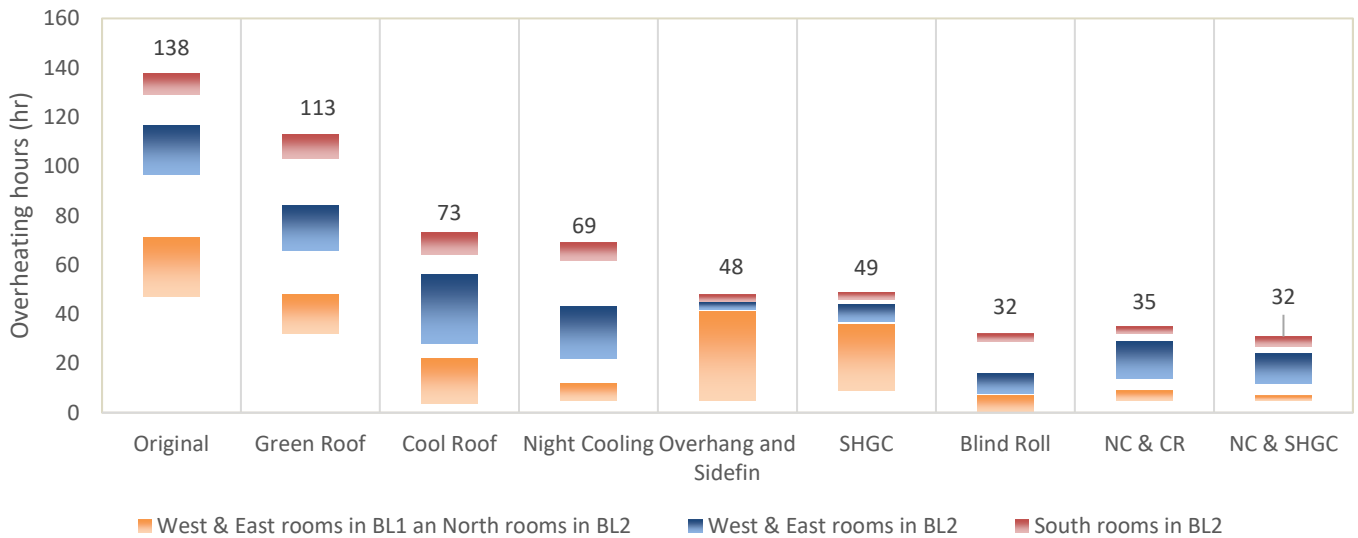

Fig.14 THERMAL CONDITION OF CLASSROOMS UNDER 2020 WITH VARIOUS SUGGESTIONS FOR MITIGATION MEASURES

Performance Evaluation

5. Performance Evaluation

Optimisation potentials for improving indoor thermal conditions under future years

Under 2044, blind shading will be able to reduce the overheating hours from 250 hrs. (red dots in Figure 15) to 60 hrs. (purple dots in Figure 15), which is still above the requirements of BB101. Therefore, the addition of night cooling to blind shading can reduce the overheating hours to 10 hrs. (orange dots in Figure 15) in the hottest room based on Cat. I and can achieve BB101 Criteria 2 (daily weighted exceedance).

Under 2090, the combination of blind roll and night cooling reduces the overheating hours to 80 hrs. based on Cat. I, as shown in Figure 15. Therefore, the cool roof measures are applied with the blind roll and night cooling. This combination will be able to reduce the overheating hours based on Cat. I to 30 hrs. in the hottest room and can achieve BB101 Criteria 2.

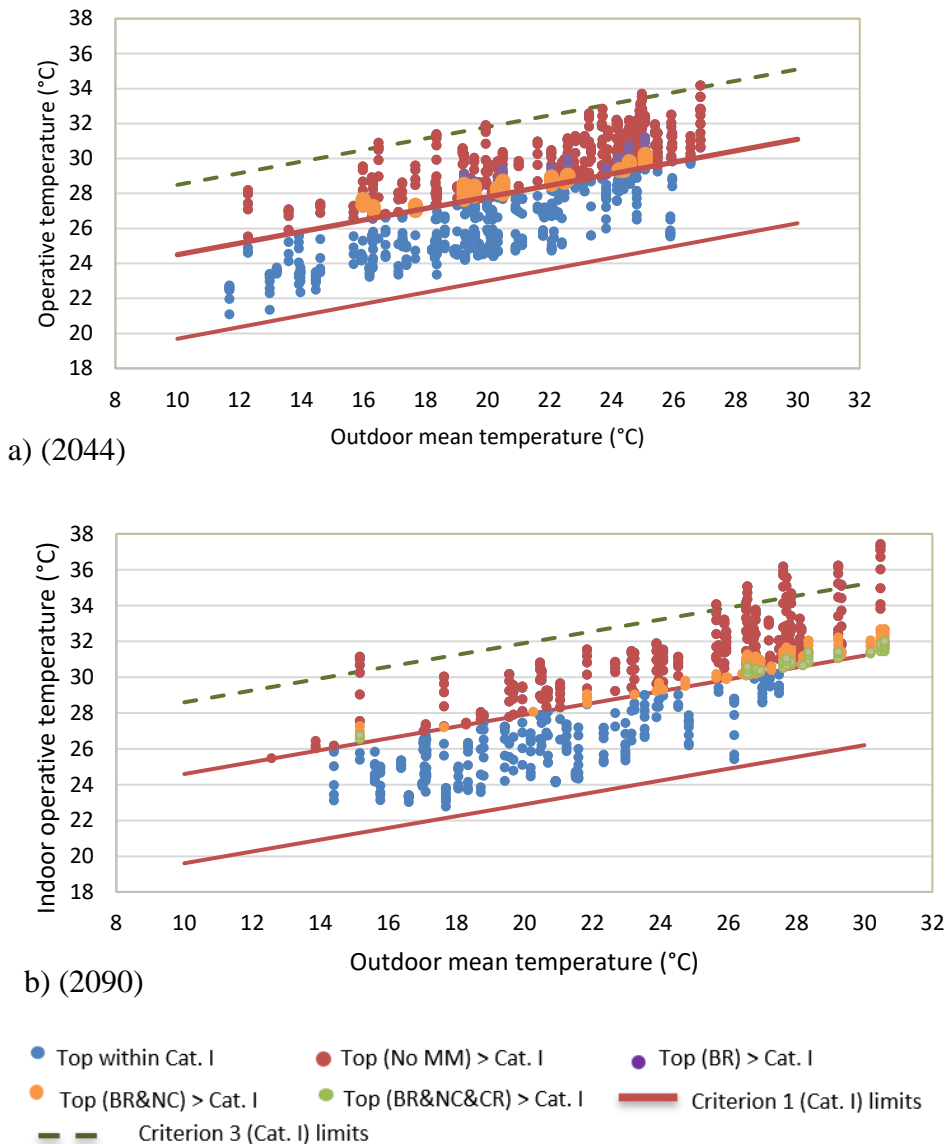

Fig.15 INDOOR OPERATIVE TEMPERATURE WITH VARIOUS MITIGATION MEASURES IN ROOM 200 UNDER SUMMER 2020, 2044 AND 2090 (BABA ET AL., 2023)

Performance Evaluation

5. Performance Evaluation

5.2 Energy consumption for heating

The total heat consumption for the period January 2020 - December 2020 is around 233,000 kWh.

The simulated specific heating energy consumption is 80.5 kWh/m²a. The building is exclusively heated by hot water radiators. Figure 16 below shows the monthly electricity use structure.

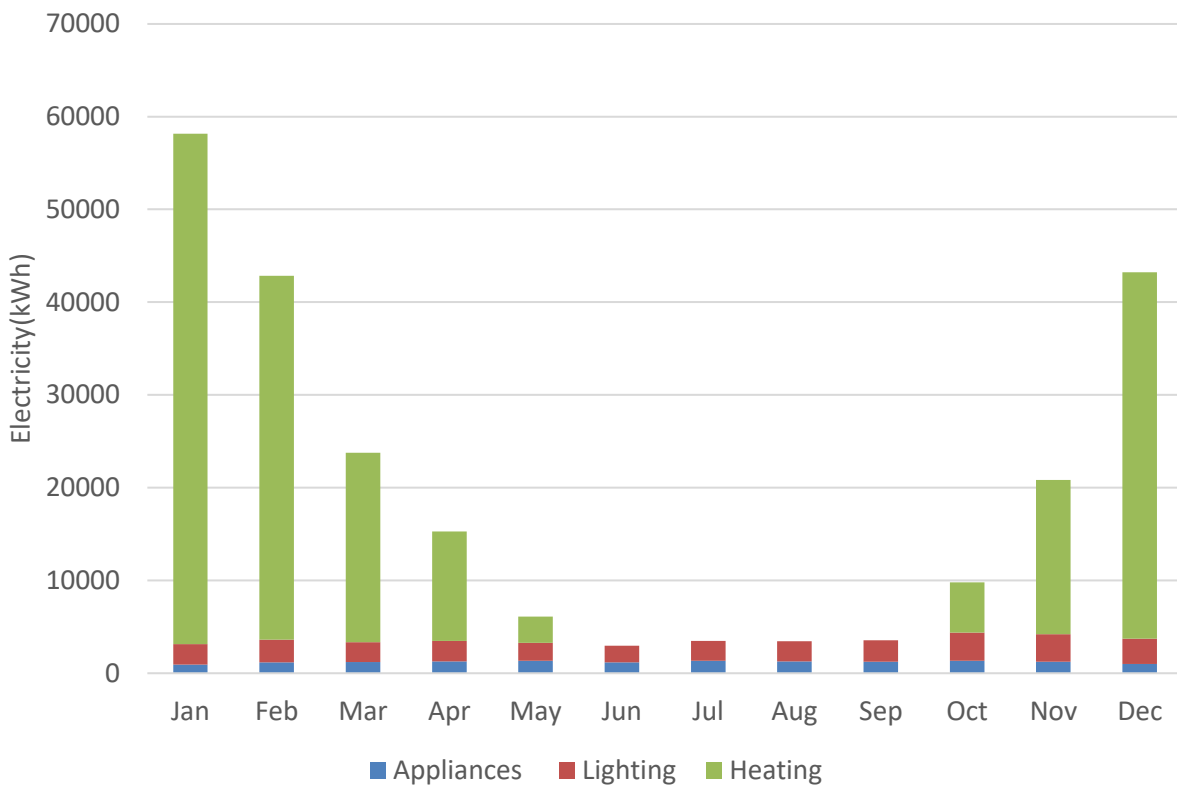

Fig.16 MONTHLY ENERGY USE, GRANDS-ÊTRES SCHOOL

6. Discussion, Lessons Learned

6.1 Summary

The Grands-Êtres school was built in two different periods. Block 1 was built in 1950, and Block 2 in 1990. This school provides space for classrooms, offices, meeting rooms, and gyms. It was built according to energy requirements of the time, with heavy-weight construction and building envelope. Two classrooms in Block 1 and three classrooms in Block 2 were selected to measure the indoor thermal conditions.

To evaluate the indoor thermal condition of the school building using the BB101 requirement, the indoor thermal condition must be evaluated during the whole summer (May 1st to September 30th) building as if the school was normally occupied. Therefore, the measured indoor temperature data is used to validate the simulated indoor temperature. As many building parameters are uncertain in this case, a novel calibration method (Baba et al., 2022) is used to make the simulated indoor air temperature of the model reflect the measured interior temperature.

The overheating risk must be assessed under the future extreme years to study the impact of climate change on indoor thermal conditions. The future climate generation and extreme future years methods adopted from "Annex80 Group Weather Data" are used.

Resilient cooling technologies are evaluated under 2020, 2044, and 2090. Passive resilient cooling technologies that can be added to the building with minor renovation are studied to improve indoor operative temperature without increasing the cooling consumption.

6.2 Optimisation potential

Optimizing indoor comfort in summer

- Despite the availability of natural ventilation and internal shading, there are more than 130 overheating hours in the summer of 2020, especially in classrooms located on the south side in Block 1. In addition, the indoor daily weighted exceedance in the hottest classroom reached 14 °C/day, exceeding the requirements of the BB101 guide.
- The use of exterior blind roll (screen shading) or a combination of night cooling and other mitigation measures to reduce solar heat gain (such as cool roof, exterior overhang, lower window SHGC) can achieve acceptable thermal conditions by reducing the overheating hours from 130 to 35 hrs. and the indoor daily weighted temperature from 12 to below 6 °C/day for all days.
- The number of heatwaves will increase from four heatwaves in the historical period (2001-2020) to 38 heatwaves in the mid-term (2041-2060) and 88 in the long-term (2081-2100) future years. Using the operational method of heatwave detection, the year 2020 was the hottest in the historical period and 2044 and 2090 will be the hottest years in mid and long-term future periods, respectively. The risk of overheating in the hottest classroom with the current operating situation will increase to 240 hrs. and 320 hrs. in 2044 and 2090, respectively, if no mitigation measures are applied.
- The use of the night cooling combined with the exterior blind roll reduces the overheating hours to 10 hrs. in 2044, but in 2090 additional measures such as the addition of a cool roof should be considered, which can reduce the overheating hours to 30 hrs., which would be within the acceptable limit (40 hrs).

References & Key Contacts

7. References & Key Contacts

7.1 References

ASHRAE, ANSI/ASHRAE Standard 169-2013, Climatic Data for Building Design. Atlanta: ASHRAE, 2013.

Baba, F. M., Ge, H., Wang, L. L., & Zmeureanu, R. (2023). Assessing and mitigating overheating risk in existing Canadian school buildings under extreme current and future climates. *Energy and Buildings*, 279, 112710.

Baba, F. M., Ge, H., Zmeureanu, R., & Wang, L. L. (2022). Calibration of building model based on indoor temperature for overheating assessment using genetic algorithm: Methodology, evaluation criteria, and case study. *Building and Environment*, 207, 108518.

Baba, F. M., Ge, H., Wang, L. L., & Zmeureanu, R. (2022). Do high energy-efficient buildings increase overheating risk in cold climates? Causes and mitigation measures required under recent and future climates. *Building and Environment*, 219, 109230.

Zhang, C., Kazanci, O. B., Attia, S., Levinson, R., Lee, S. H., Holzer, P., ... & Heiselberg, P. (2023). IEA EBC Annex 80-Dynamic simulation guideline for the performance testing of resilient cooling strategies: Version 2.

Baba, F. M., Ge, H., Zmeureanu, R., & Wang, L. L. (2023). Optimizing overheating, lighting, and heating energy performances in Canadian school for climate change adaptation: Sensitivity analysis and multi-objective optimization methodology. *Building and Environment*, 110336.

BB101. (2018). *Building Bulletin 101: Guidelines on ventilation, thermal comfort and indoor air quality*. Department for Education and Skills (DfES). London

7.2 Contacts

Company	Role	Contact
British University in Dubai	Assistant professor	Fuad Baba Fuad.Baba@buid.ac.ar

Introduction & Climate

1. Introduction & Climate

1.1 Introduction

The long-term care building is located in the mid-east of Montreal Island, Canada. The building is L-shaped and composed of five floors above the ground and a below-grade basement. The building shape and orientation are shown in Figure 1. The total length and width of the building are 44 m and 42 m, respectively. The size of a typical private patient room in the building is 5.4 m x 3.6 m. The building was constructed in 1980 with exterior walls made of concrete block and solid brick veneer cladding. On the first floor, there are hallway spaces, a lounge area, a food preparation area, patient rooms, and offices. Stairways and elevator shafts connect the building floors. The second to fifth floors have similar layouts, with each floor composed of a lounge room, patient rooms, and offices. The patient rooms are a mixture of private rooms with a patient room and a bathroom, and semi-private rooms with two patients sharing the same bathroom. The semi-private rooms are joined together through a common door.

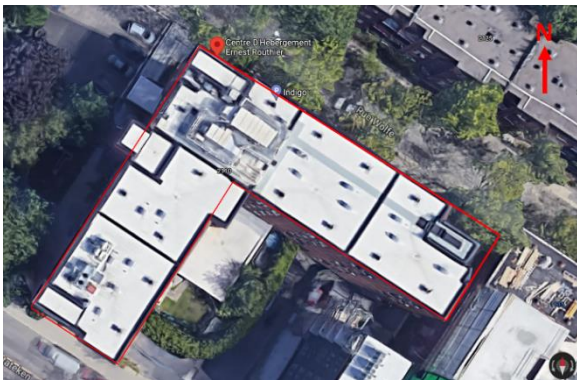

Fig.1 SHAPE AND ORIENTATION OF THE MONITORED LONG-TERM CARE BUILDING

1.2 Local Climate

Location: The building is located at 2110 Rue Wolfe, Montréal, QC H2L 4V4. Coordinate: 45.52, -73.56.

Climate Zone: The building is located in a Warm Summer Continental Climate zone. 6A (ASHRAE), DFA (Historical KOPPEN-GEIGER MAP), AND DFB (Future KOPPEN-GEIGER MAP).

Table.1 KEY INFORMATION ABOUT THE BUILDING

Location	Montreal, Canada
Building Type	Long-term care building
Retrofit (Y/N)	Y
Surroundings (Urban/Rural)	Urban
Year of Completion	1980
Floor Area (m²)	1848
Window to Wall Ratio (%)	14.13
Climate Zone	Warm Summer Continental Climate (6A)
Heating Degree days 12/20 (Kd)	4013

Climate Zone	Description
EX	Extremely Hot Humid
EH	Extremely Hot Dry
1A	Very Hot Humid
1B	Very Hot Dry
2A	Hot Humid
2B	Hot Dry
3A	Warm Humid
3B	Warm Dry
4C	Warm Marine
4A	Mixed Humid
4B	Mixed Dry
4C	Mixed Marine
5A	Cool Humid
5B	Cool Dry
5C	Cool Marine
6A	Cold Humid
6B	Cold Dry
7	Very Cold
8	Subarctic

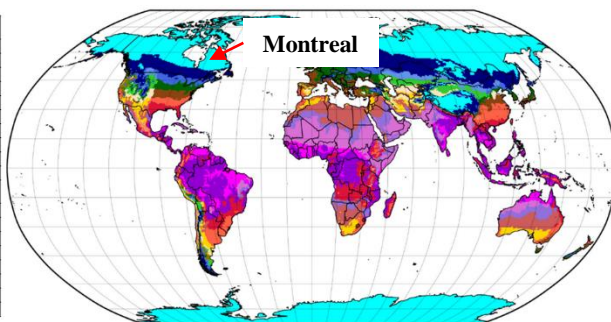

Fig.2 CLIMATE MAP (ASHRAE 169 - CLIMATE DATA FOR BUILDING DESIGN STANDARDS)

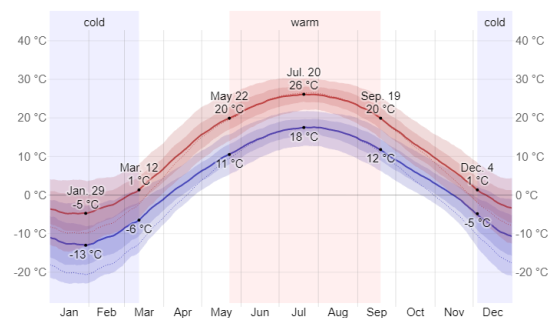

Fig.3 AVERAGE HIGH AND LOW TEMPERATURE IN MONTREAL ([HTTPS://WEATHERSPARK.COM/](https://weatherspark.com/))

Building Information

2. Building

2.1 Envelope and Construction

The building is a long-term care building for older people. It was completed in 1980s.

Special features of the building envelope and construction

- L-shaped and five floors above the ground and a below-grade basement
- Exterior walls are made of concrete block and solid brick veneer cladding
- The exterior door was made from painted oak
- The internal doors of patient rooms are wooden doors
- The windows are double clear glass with aluminum frame and the maximum window opening area is 10%
- The interior shading is vertical blinds with manually controlled.

Table.2 INFORMATION PLANNING, OPERATION AND USE

Information on planning, operation and use

Object use	Long-term care building of older people
Technical management	Under the management of CHSLD - Centres d'hébergement et de soins de longue durée à Montréal
Energy monitoring	There is no dedicated monitoring system in the building.

Table.3 BUILDING PROPERTIES

Property	Unit	Value
Hours of occupancy	h/week	168
Window U-value	W/(m ² K)	2.72
Wall U-value	W/(m ² K)	0.3
Roof U-value	W/(m ² K)	0.25
Floor U-value	W/(m ² K)	0.33
Window to Wall Ratio	%	14.13
Air-tightness (@ 50 Pa)	1/h	0.5



Fig.4 BUILDING MODEL DEVELOPED BY THE DESIGN BUILDER

2. Building

2.2 Energy Systems

Schematic design of energy system

There was no central cooling system in the real building. Window air conditioners are used in some of patient rooms and portable ACs are used in the lounge spaces on each floor. A mechanical ventilation system is applied to lounge areas to provide fresh air. Exhaust fans are used in each bathroom of patient rooms.

Description of Energy System

Heating System

The heating system of the monitored building used electric baseboard heating for all heated spaces. This applied to the corridor spaces, lounge and eating areas, patient rooms, and stairways.

Cooling System

There is no central cooling systems. There are window air conditioners in some patient rooms including #223, 523, 525, and 544. Portable ACs are used in the five lounge areas 108, 207, 307, 407 and 507. Mechanical ventilation system provide fresh air to the lounge spaces.

Electrical Power Supply

Electricity consumption is covered by the public grid.

Resilient Cooling

3. Resilient Cooling

3.1 Principles

Passive cooling strategies were applied to the building and the efficiency of controlling overheating was evaluated. Wall and roof were retrofitted for higher insulation level. The window type were changed from double clear soft low-e to Electrochromic with soft low-e coating. Exterior shading (ES), Window opening area 50% (NV), Green roof (GF) (Extensive), and Night ventilation (NiV) were applied to mitigate building overheating problem.

3.2 Structure of resilient cooling technology

Table.4 STRUCTURE OF THE SYSTEM

1. Reducing heat loads to people and indoor environments	
1.1.	Advanced solar shading
1.2.	Advanced cool materials
1.3.	Advanced glazing technologies
1.4.	Ventilated façades
1.5.	green roofs, green façades
2. Removing heat from indoor environments (production, emission and combined)	
2.1.	Ventilative cooling
2.2.	Thermal mass utilization
2.3.	Evaporative cooling
2.4.	Sky radiative cooling
2.5.	Compression refrigeration machines
2.6.	Adsorption chillers
2.7.	Natural heat sinks
2.8.	Radiant Cooling
3. Increasing personal comfort apart from space cooling	
3.1.	Comfort ventilation and elevated air movement
3.2.	Micro-cooling and personal comfort control
4. Removing latent heat from indoor environments	
4.1.	Dehumidification

Table.5 BUILDING ENVELOPE PARAMETERS AND CHANGES

Object	Parameter	Unit	Original	Mitigation
Wall	Wall U-Value	W/m ² K	0.3	0.2
Roof	Roof U-Value	W/m ² K	0.25	0.16
Window	Window U-Value	W/m ² K	2.72	1.38
Window	Window SHGC	-	0.37	0.074

Table.6 MITIGATION STRATEGIES

Original building		Retrofit building
Shading	Interior blinds	Exterior shading (ES) Solar transmittance 0.05; Solar reflectance 0.4; Thickness 0.002m; Conductivity 0.19 W/m·K
Natural ventilation	Window opening area 10%	Window opening area 50% (VN) Windows are open when the indoor temperature is higher than 26°C and higher than the outdoor temperature[
Roof	Regular roof	Green roof (GF) (Extensive) Height of plants 0.3 m; Leaf area index (LAI) 3; Leaf emissivity 0.9; Leaf reflectivity 0.2; Substrate thickness 0.1 m; Conductivity of dry soil 0.4 W/(m·K); Thermal absorption of soil 0.96
Night ventilation (NV)	No	Exhaust fans Operating time 9pm ~ 10am; Design pressure rise 420Pa; Fan total efficiency 0.6; Maximum air change rate 5h ⁻¹
Two strategies combination	/	ES+GF, ES+NV, ES+VN, GF+NV, GF+VN, NV+VN
Three strategies combination	/	ES+GF+NV, ES+GF+VN, ES+NV+VN, GF+NV+VN, ES+GF+VN
Four strategies combination	/	ES+GF+NV+VN

KPI Evaluation

4. KPI Evaluation

4.1 Thermal Comfort KPIs

Indoor Overheating Degree (IOD) and Ambient Warmness Degree AWD18 = 2.73

Fig.5 shows the IOD and OEF of the original building and retrofitted buildings with different strategies. FTL means the fixed temperature limit. ATL means the adaptive temperature limit.

OEF are lower than 1, which means the building can resist the climate change under current climate scenario.

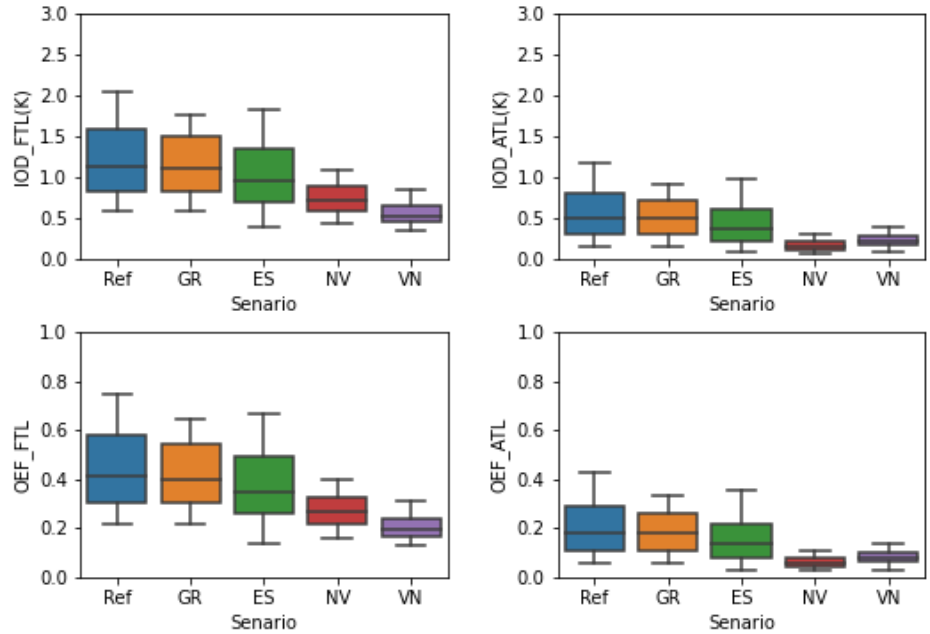

Fig.5 IOD AND OEF OF ORIGINAL BUILDING AND RETROFITTED BUILDINGS WITH DIFFERENT STRATEGIES

Unmet Hours / Exceedance Hours

Fig.6 illustrates the unmet hours distribution across all thermal zones in both the original and retrofitted buildings, applying different strategies. FTL means the fixed temperature limit, while ATL means the adaptive temperature limit. To interpret this figure, consider the reference building (labeled 'Scenario = Ref'): the unmet hours across various thermal zones vary from under 1000 to upwards of 3000, with approximately 10 zones experiencing 2000 unmet hours. In contrast, the naturally ventilated scenario (labeled 'Scenario = NV') shows most thermal zones with unmet hours falling below 1000.

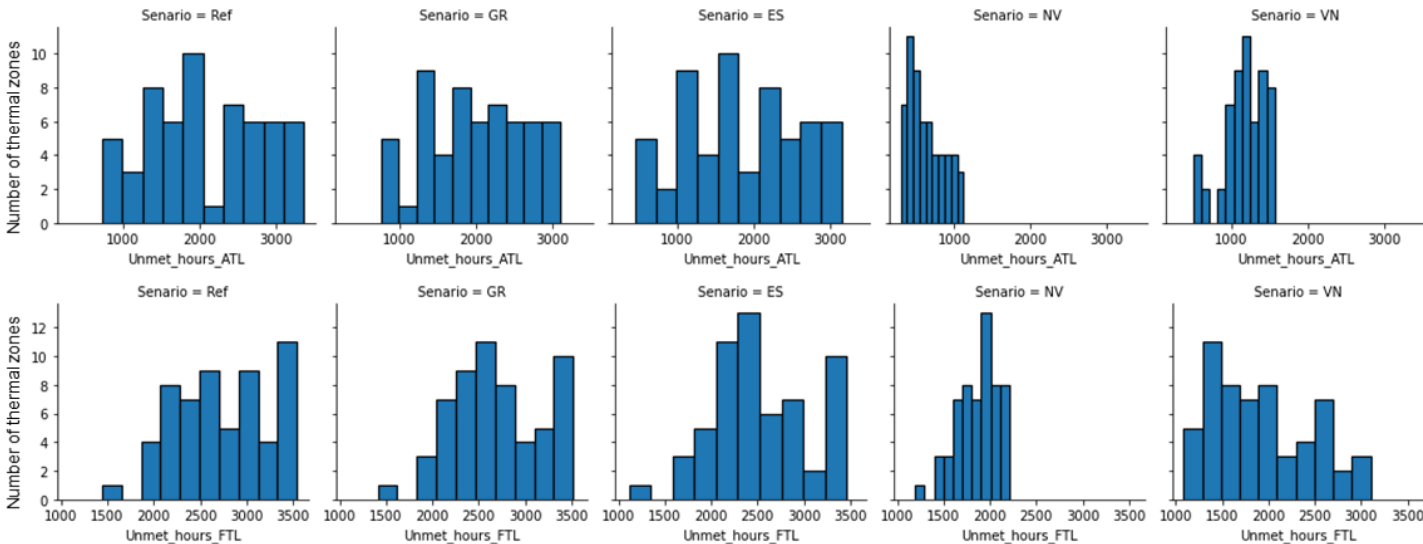

Fig.6 DISTRIBUTION OF UNMET HOURS OF ORIGINAL BUILDING AND RETROFITTED BUILDINGS WITH DIFFERENT STRATEGIES

Performance Evaluation

5. Performance Evaluation

5.1 Comfort

The room located on the south-west side and top floor of the building is used to analyze the comfort and overheating problem. Fig.7 shows the indoor (T_{in}) and outdoor temperature (T_{out}) of the room as well as the fixed temperature limit of 28°C (FTL_28) of building overheating from CIBSE Guide A. The number of hours that exceeds 28°C limit is 577 hours. Fig. 8 shows the indoor (T_{in}) and outdoor temperature (T_{out}) of the room as well as the adaptive temperature limit (ATL), which is calculated based on the running mean outdoor temperature (T_{m}) from CIBSE TM 52.

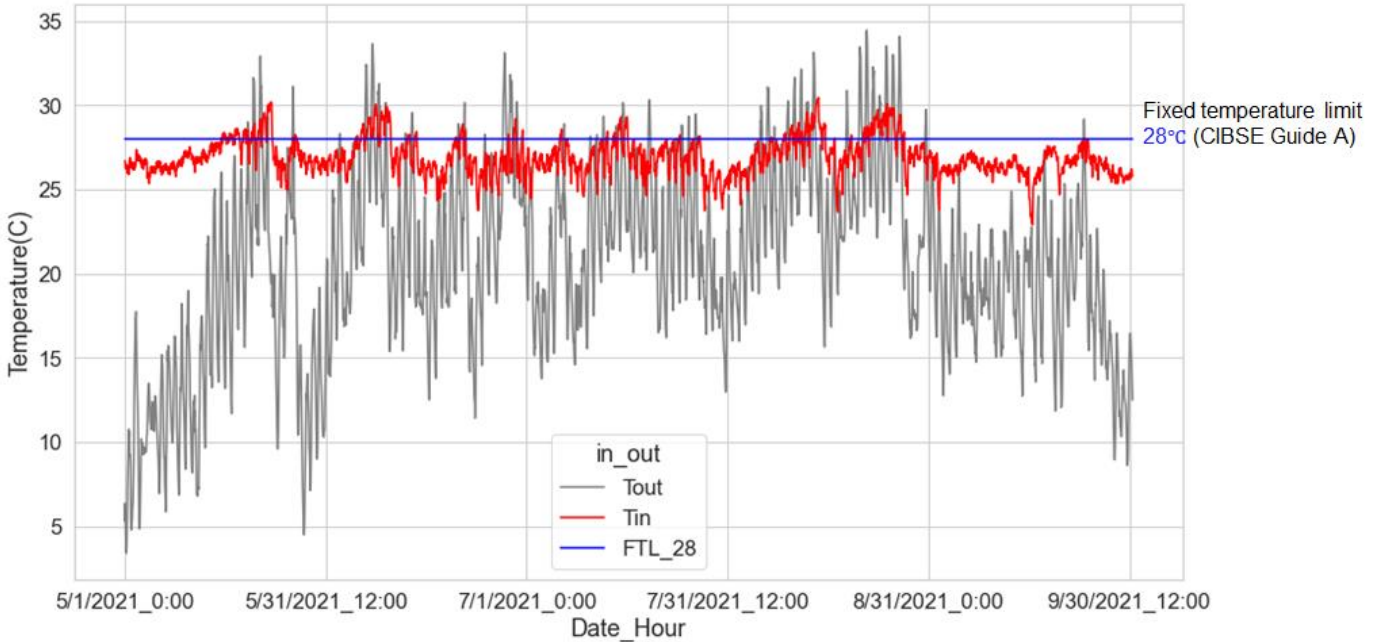

Fig.7 HOURLY TEMPERATURE IN SUMMER 2021 WITH THE FIXED TEMPERATURE LIMIT OF 28°C FROM CIBSE GUIDE A

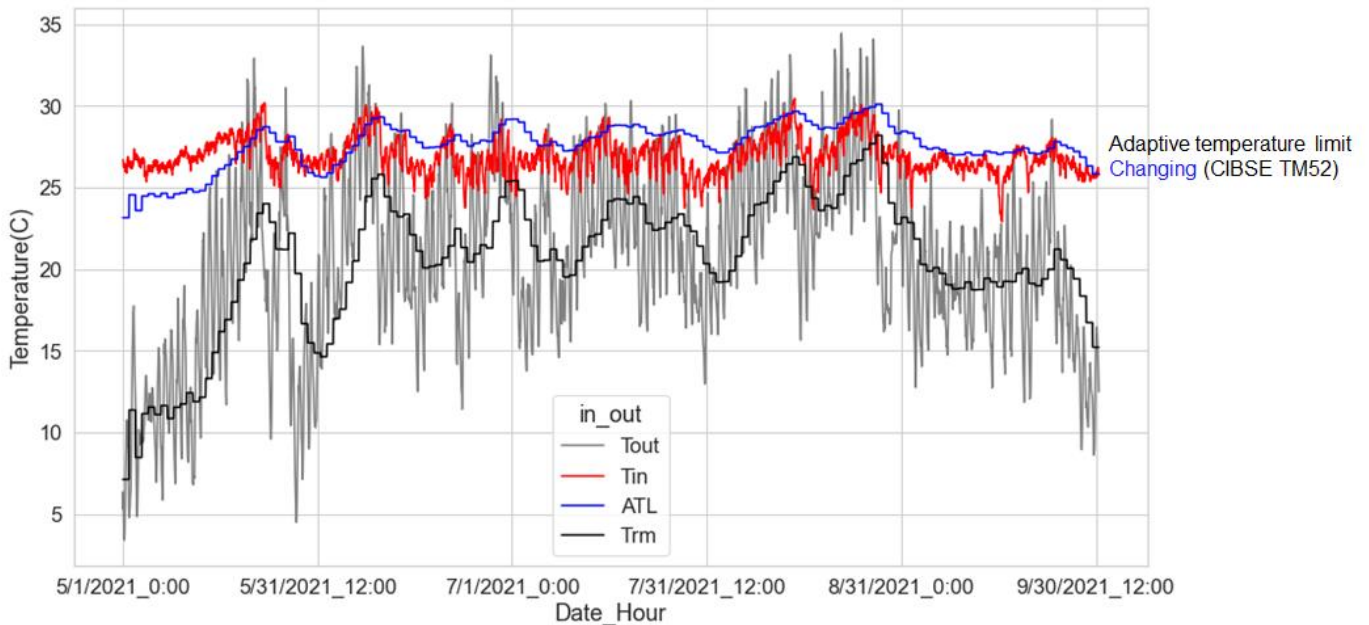

Fig.8 HOURLY TEMPERATURE IN SUMMER 2021 WITH THE ADAPTIVE TEMPERATURE LIMIT AND RUNNING MEAN OUTDOOR TEMPERATURE FROM CIBSE TM 52

Performance Evaluation

5. Performance Evaluation

Fig.9 shows the adaptive temperature and indoor temperature changing with running mean outdoor temperature. According to the three overheating criteria of CIBSE TM52, the hours of exceedance (H_e) is 518 hours, the Daily weighted exceedance (W_e) is 79 °C·h and Upper limit temperature (T_{upp}) is 3.74 °C.

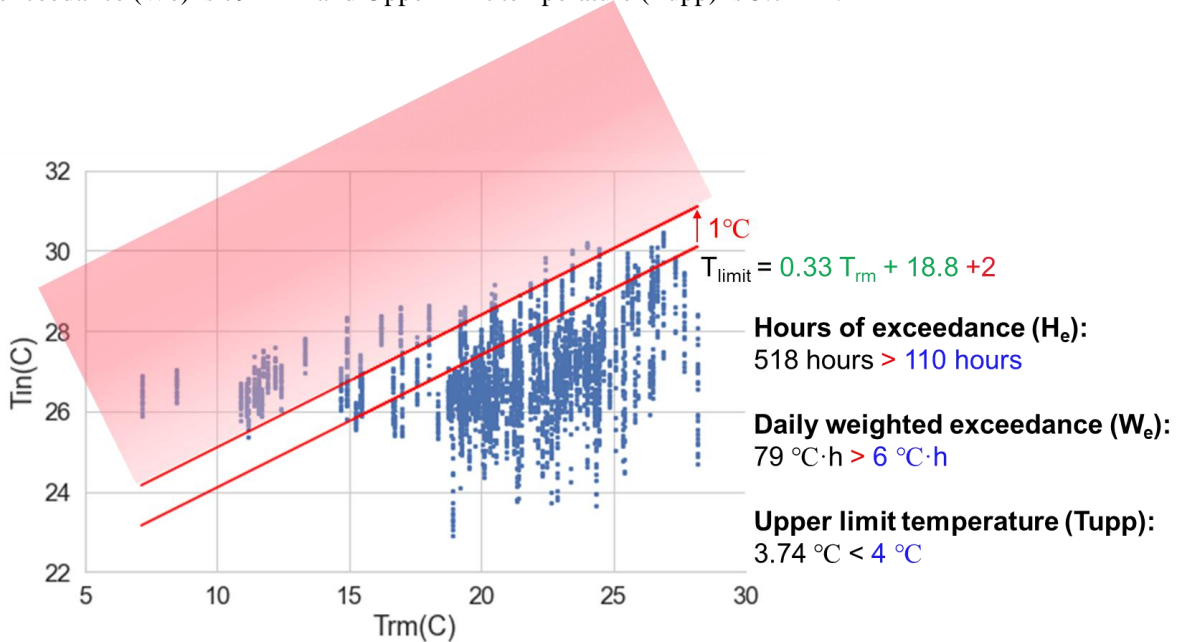

Fig.9 ADAPTIVE TEMPERATURE LIMIT AND INDOOR HOURLY MEAN TEMPERATURE

Fig.10 indoor standard effective temperature (SET) of the room and the SET limit of building overheating from the overheating guideline of National Research Council Canada (NRCC). Based on the guideline, overheating events were selected throughout the period, as the orange line shows. The orange shading indicate an overheating event that has longest duration in this summer. According to the definition of NRCC guideline, the duration of the overheating event is 6 days, the severity is 74 °C·h and the intensity is 0.51°C. This method defines an individual indoor overheating event, facilitating further exploration of the event's impact from the perspective of human heat stress.

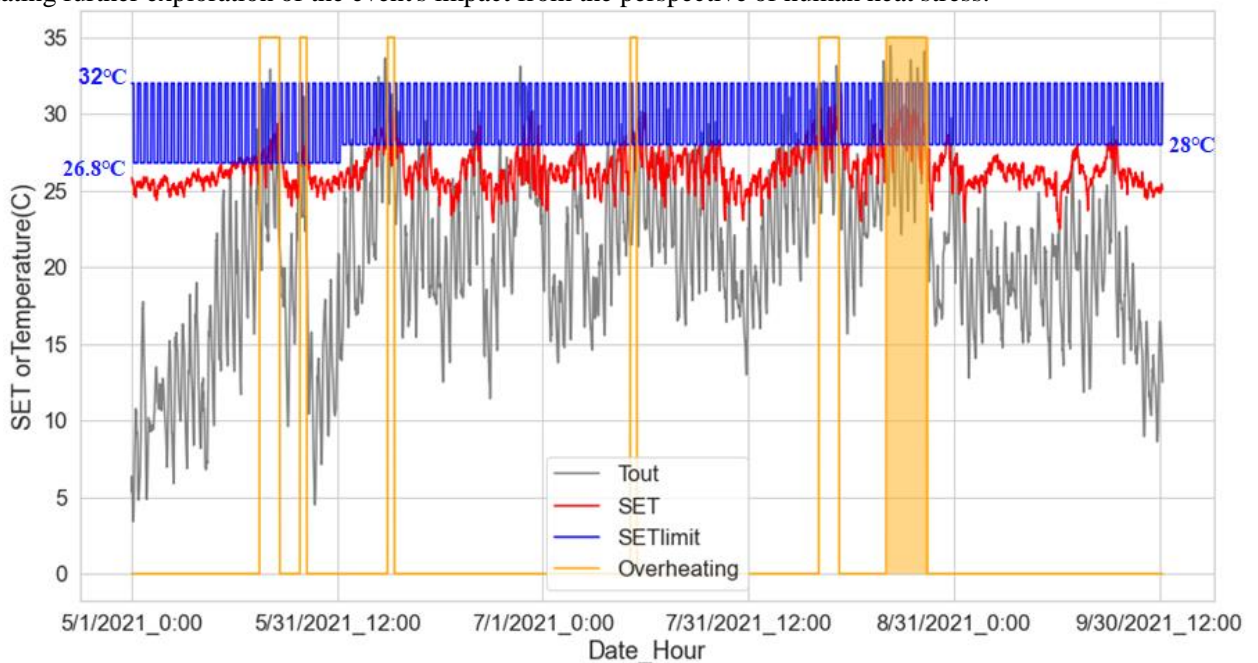

Fig.10 INDOOR STANDARD EFFECTIVE TEMPERATURE (SET) OF THE ROOM AND THE SET LIMIT OF BUILDING OVERHEATING FROM NRCC

Performance Evaluation

5. Performance Evaluation

Fig. 11 and Fig. 12 show the indoor overheating hours of the original and different retrofitted buildings based on the fixed temperature limit and adaptive temperature limit, respectively. A retrofitted building is named by the retrofitted strategy applied on it. With individual strategy, the NV (natural ventilation) is the most efficient to control the overheating problem. The combination of strategies can further decrease the overheating time.

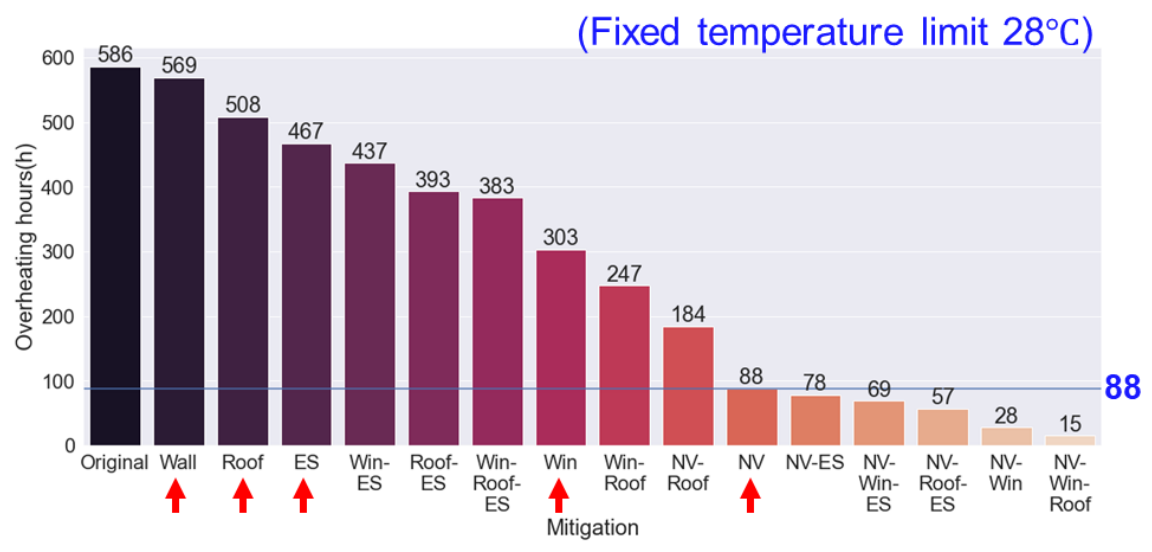

Fig.11 OVERHEATING HOURS OF THE ORIGINAL AND RETROFITTED BUILDINGS BASED ON FIXED TEMPERATURE LIMIT

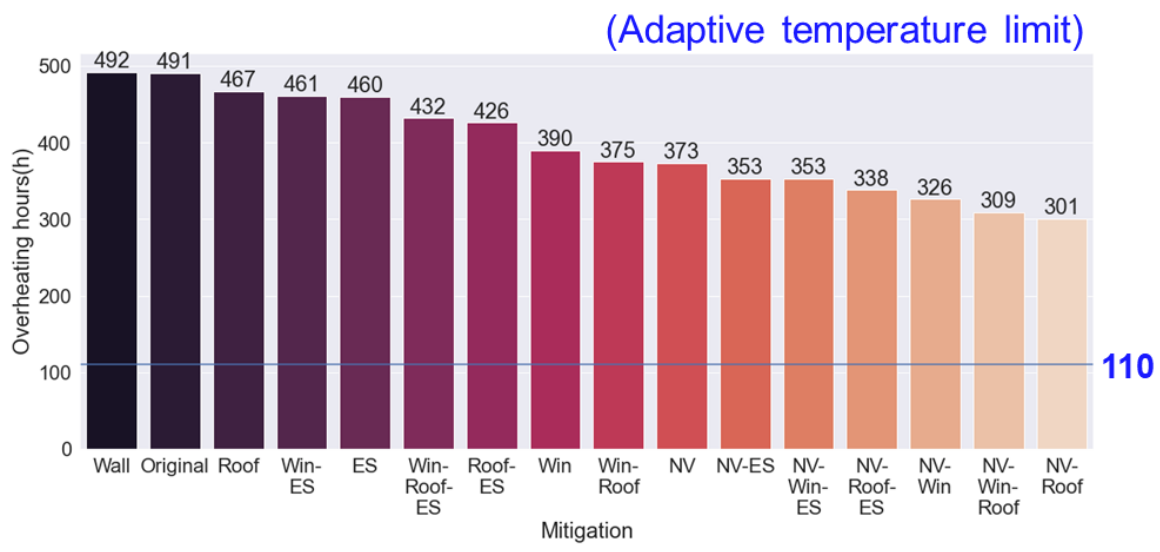

Fig.12 OVERHEATING HOURS OF THE ORIGINAL AND RETROFITTED BUILDINGS BASED ON ADAPTIVE TEMPERATURE LIMIT

Performance Evaluation

5. Performance Evaluation

Fig. 13 and Fig. 14 show the Daily weighted exceedance (We) and Upper limit temperature (Tupp) of the original and different retrofitted buildings based on the adaptive temperature limit.

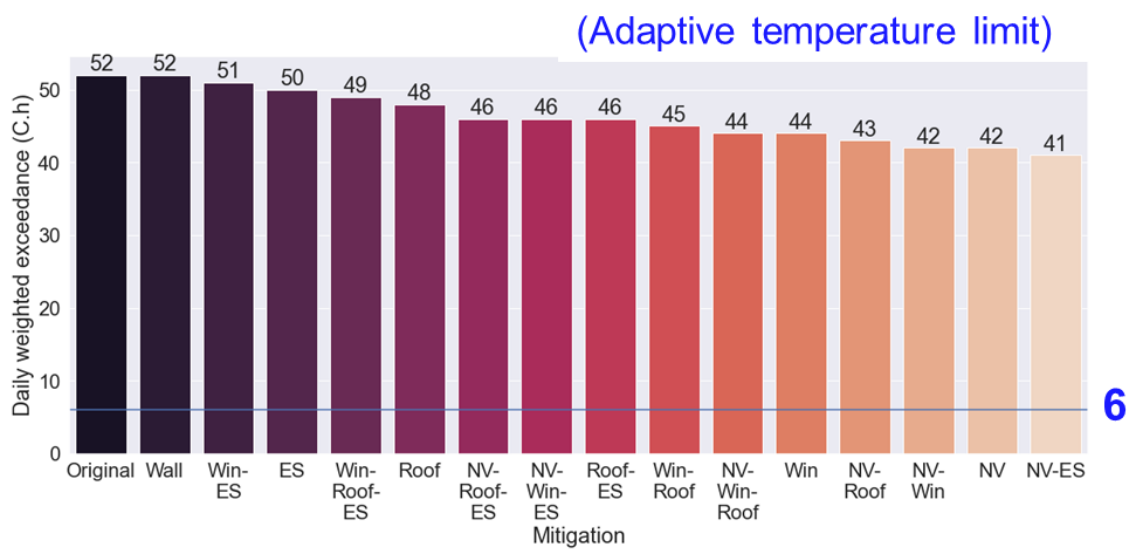

Fig.13 DAILY WEIGHTED EXCEEDANCE (We) OF THE ORIGINAL AND RETROFITTED BUILDINGS BASED ON ADAPTIVE TEMPERATURE LIMIT

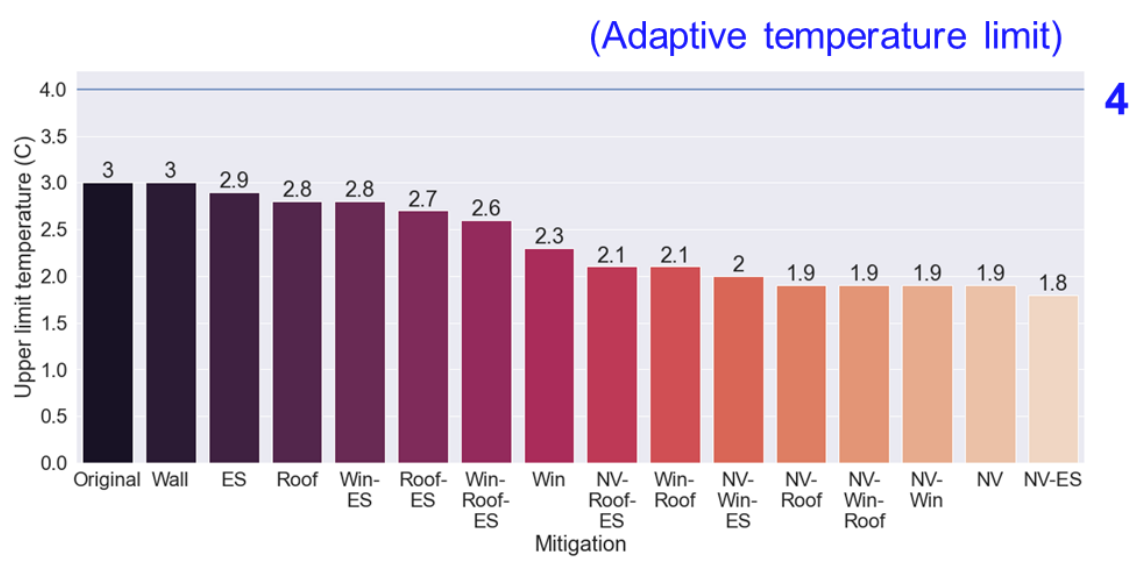

Fig.14 UPPER LIMIT TEMPERATURE (Tupp) OF THE ORIGINAL AND RETROFITTED BUILDINGS BASED ON ADAPTIVE TEMPERATURE LIMIT

Performance Evaluation

5. Performance Evaluation

Fig. 15 shows the maximum overheating duration, severity and intensity and their limitation based on NRC overheating guideline.

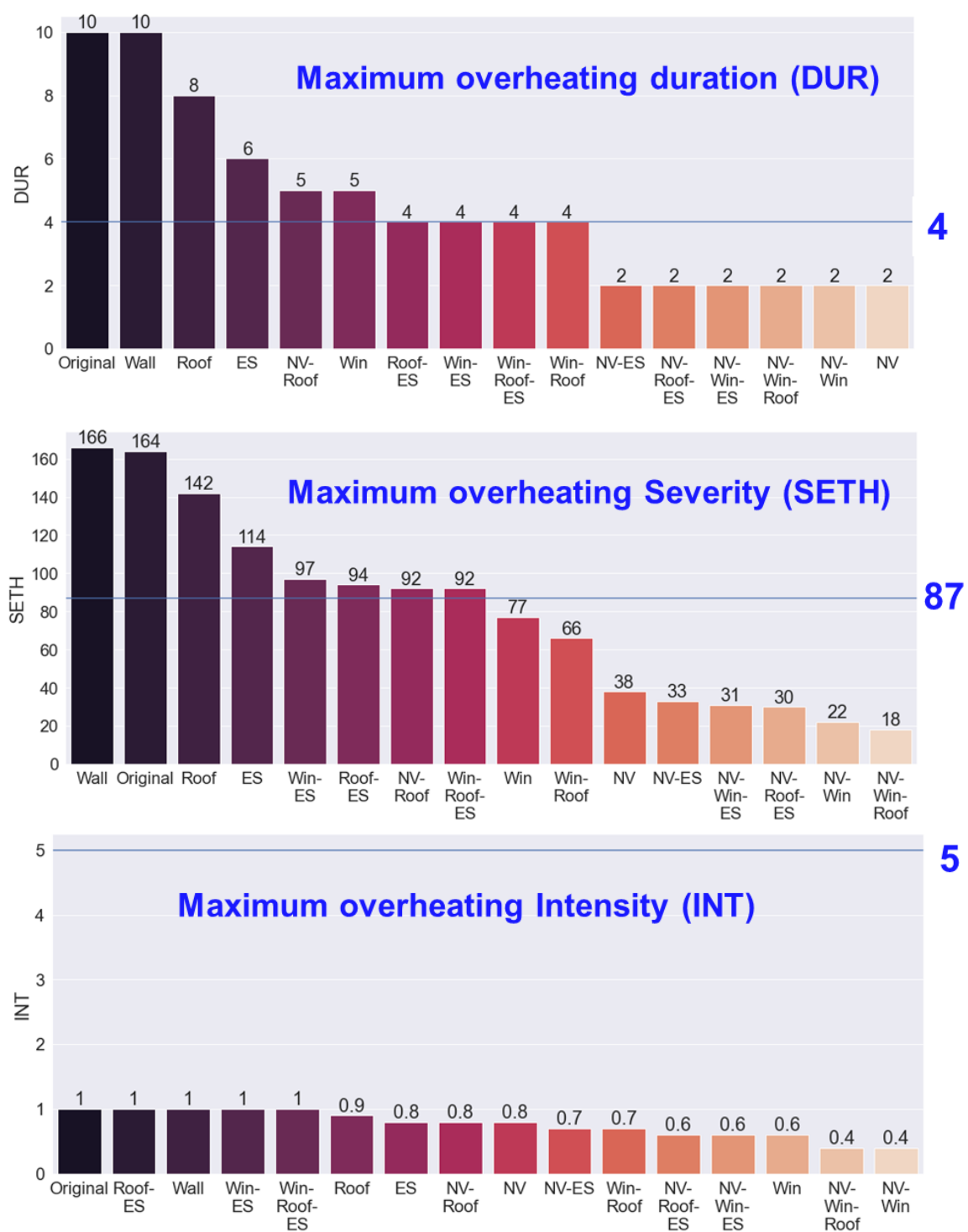

Fig.15 MAXIMUM OVERHEATING DURATION, SEVERITY AND INTENSITY BASED ON NRC OVERHEATING GUIDELINE

Lessons Learned

6. Discussion, Lessons Learned

6.1 Summary

- Among the investigated four individual strategies, natural ventilation is the most efficient in reducing the overheating degree and hours for all the thermal zones of the building.
- Combination of strategies can further decrease the overheating risk. The combination of natural ventilation and exterior shading is recommended due to its efficiency and economy.

6.2 Optimisation potential

- Increasing natural ventilation by opening windows can decrease the overheating risk.
- Replacing interior shading with exterior shading is another way to deal with overheating problem.
- Considering the long-term care building is occupied by vulnerable people (older people), more mitigations are needed to deal with the overheating.

7. References & Key Contacts

7.1 References

- [1] Ji, L., Shu, C., Laouadi, A., Lacasse, M., & Wang, L. (Leon). (2023). Quantifying improvement of building and zone level thermal resilience by cooling retrofits against summertime heat events. *Building and Environment*, 229. <https://doi.org/10.1016/j.buildenv.2022.109914>
- [2] Ji, L., Laouadi, A., Wang, L., & Lacasse, M. A. (2022). Development of a bioheat model for older people under hot and cold exposures. *Building Simulation*, 15, 1815–1829. <https://doi.org/https://doi.org/10.1007/s12273-022-0890-3>
- [3] Ji, L., Laouadi, A., Shu, C., Gaur, A., Lacasse, M., & Wang, L. (Leon). (2022). Evaluating approaches of selecting extreme hot years for assessing building overheating conditions during heatwaves. *Energy and Buildings*, 254, 111610. <https://doi.org/10.1016/j.enbuild.2021.111610>
- [4] Shu, C., Gaur, A., Wang, L., & Lacasse, M. A. (2023). Evolution of the local climate in Montreal and Ottawa before, during and after a heatwave and the effects on urban heat islands. *Science of The Total Environment*, 890, 164497. <https://doi.org/10.1016/j.scitotenv.2023.164497>
- [5] Shu, C., Gaur, A., Wang, L. (Leon), Bartko, M., Laouadi, A., Ji, L., & Lacasse, M. (2022). Added value of convection permitting climate modelling in urban overheating assessments. *Building and Environment*, 207. <https://doi.org/10.1016/j.buildenv.2021.108415>
- [6] Laouadi A, Ji L, Shu C, Wang L, Lacasse MA. Overheating Risk Analysis in Long-Term Care Homes—Development of Overheating Limit Criteria. *Buildings*. 2023; 13(2):390. <https://doi.org/10.3390/buildings13020390>
- [7] CIBSE. (2006). Environment Design-CIBSE Guide A. In The Chartered Institution of Building Services Engineers. <https://doi.org/10.1016/b978-0-240-81224-3.00016-9>
- [8] CIBSE. (2013). The limits of thermal comfort : avoiding overheating in European buildings-CIBSE TM52. In The Chartered Institution of Building Services Engineers. <https://doi.org/10.1017/CBO9781107415324.004>
- [9] Laouadi A, Bartko M, & Lacasse, G. A. (2016). Climate Resilience Buildings: Guideline for management of overheating risk in residential buildings.
- [10] ASHRAE, ANSI/ASHRAE Standard 169-2013, Climatic Data for Building Design. Atlanta: ASHRAE, 2013.

7.2 Contacts

Company	Role	Contact
Concordia University & National Research Council Canada (NRCC)	Postdoctoral Fellowship	Lili Ji lili.ji@nrc-cnrc.gc.ca
Concordia University & National Research Council Canada (NRCC)	Research Associate	Chang Shu Chang.Shu2@nrc-cnrc.gc.ca

Introduction & Climate

1. Introduction & Climate

1.1 Introduction

The Holon building, Garden A-1 is the world's first stainless steel low-carbon residential building that was built in 2021. The building has a gross floor area of around 2,968 m² and its height is 33 m. The project is 100% factory manufacturing. The construction is quite high efficiency and the building is energy saving. The apartment building is comprised of 56 modules, which are manufactured in 15 days and stacked on-site in 29 hours. The Holon building has the world's most uniform-sized modular system: each standard module is 3 m in height, 12.19 m in length and 2.44 m in width. Yet with the most varied building types and room types, it is perfectly suitable for luxury residences, 200-storey skyscrapers, and also ideal for public and residential buildings. No-column clear space reaches 12 m × (4.8~12) m inside the room, allowing flexible changes to room layout. The position and quantity of walls, doors, windows and balconies can be easily changed. After completion, the building itself can be disassembled and rebuilt in another location.



Fig.1 EXTERIOR VIEW, RESIDENTIAL PROJECT, CHANGSHA, CHINA

1.2 Local Climate

Location: Changsha, China

Changsha is 45 m above sea level and located at 28.20° N 112.97° E.

Climate zone: warm-humid, 3A climatic zone

Climate Zone	Description
0A	Extremely Hot Humid
0B	Extremely Hot Dry
1A	Very Hot Humid
1B	Very Hot Dry
2A	Hot Humid
2B	Hot Dry
3A	Warm Humid
3B	Warm Dry
3C	Warm Marine
4A	Mixed Humid
4B	Mixed Dry
4C	Mixed Marine
5A	Cool Humid
5B	Cool Dry
5C	Cool Marine
6A	Cold Humid
6B	Cold Dry
7	Very Cold
8	Subarctic

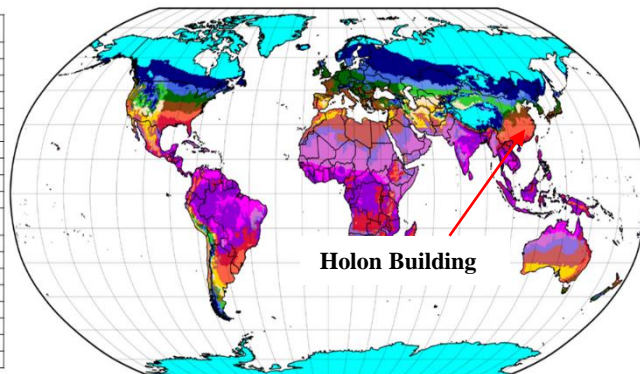

Fig.2 CLIMATE MAP (ASHRAE 169 - CLIMATE DATA FOR BUILDING DESIGN STANDARDS)

HOLON BUILDING, GARDEN A-1, CHANGSHA, CHINA

Table.1 KEY INFORMATION ABOUT THE BUILDING

Location	Changsha, China
Building Type	Residential property
Retrofit (Y/N)	N
Surroundings (Urban/Rural)	Urban
Year of Completion	2021
Floor Area (m²)	2,968
Building Volume (m³)	8904.58
Shape factor (m)	0.29
Window to Wall Ratio (%)	E:0.17 S:0.13 W:0.17 N:0.13
Climate Zone	Warm-Humid (3A)
No. of Days with Te max > 25	About 84 d (CSWD)
Cooling Season Humidity	75%

Changsha belongs to a subtropical monsoon climate. It has long summers and winters and short springs and autumns, with about 118-127 days in summer, 117-122 days in winter, 61-64 days in spring, and 59-69 days in autumn. From late May, the air temperature and rainfall of Changsha increase significantly, and it enters a rainy season. After the end of the rainy season in August, the drought begins, with extreme maximum temperatures reaching 39-40°C. The period from late November to mid-March of the following year is the winter season (Weather China, 2023).

Building Information

2. Building

2.1 Envelope and Construction

The building is a Prefabricated Prefinished Volumetric Construction (PPVC) residential property with a gross floor area of around 2,968 m² and a total of 11 floors.

Characteristics and Design of Building Enclosures

- Holon building is designed, produced, accepted, and operated per nearly zero energy building standard (GB/T 51350, 2019)
- Holon building adopts 5 mitigation measures: 22 cm rock wool for exterior walls, 3 or 4-paned glass windows, exterior shade, interior shade, and mechanical ventilation with heat recovery
- Holon building is of stainless steel structure inclusive column, beam, floor slab, balcony, window frame, stairs, roof, and guardrail
- Exterior wall uses galvalume slab and fluorocarbon paint. Wall seams are glued with silicon weather-resistance sealant. Interior wall is made of galvalume slab and PE paint.

Table.2 INFORMATION PLANNING, OPERATION AND USE

Information on planning, operation and use	
Object use	Residential use
Integral planning process	Broad, as the owner, actively managed the planning process.
Technical management	Own operational management through self-organisation of the residents with the support of external maintenance companies
Energy monitoring	There is a dedicated monitoring system in the building.

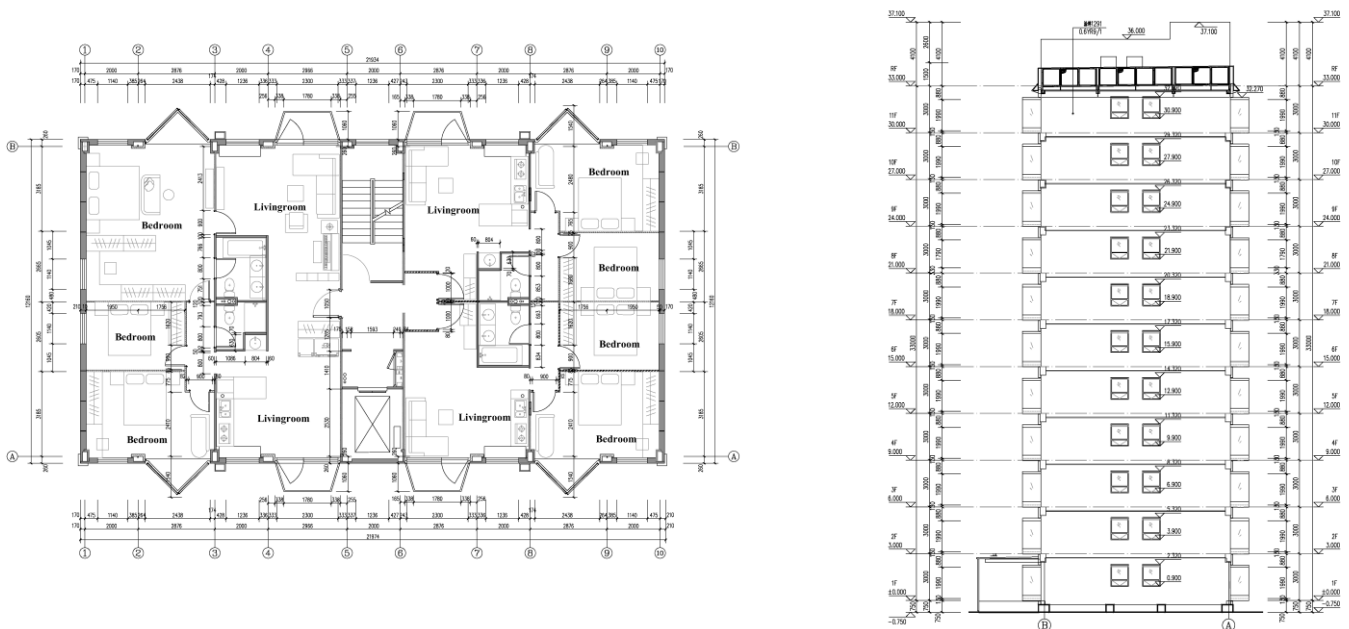

Fig.3 FLOOR PLAN, SECTION

Building Information

Envelope

- External wall: aluminized zinc colored steel plate 0.7mm + rock wool board 220mm + aluminized zinc colored steel plate 0.7mm
- Column and beam: aluminized zinc colored steel plate 0.7mm + rock wool plate 130mm + aluminized zinc colored steel plate 0.7mm
- Internal wall: aluminized zinc colored steel plate 0.4mm + rock wool board 60mm + aluminized zinc color steel plate 0.4mm
- Window: 3-paned insulating glass window (small-sized window) or 4-paned insulating glass window (large-sized window)

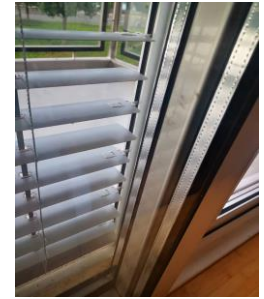
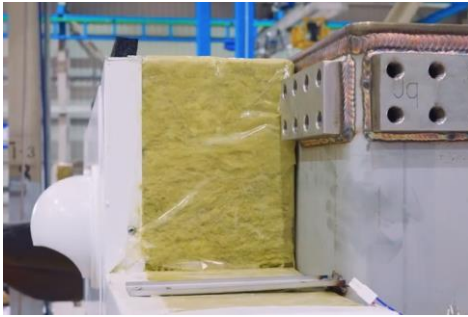

Fig.4 EXTERIOR WALL AND EXTERIOR WINDOW STRUCTURE

Table.3 HEAT TRANSFER COEFFICIENT

Exterior wall	3-paned insulating glass window	4-paned insulating glass window	Roof
0.24 W/(m ² K)	1.8 W/(m ² K)	1.4 W/(m ² K)	0.19 W/(m ² K)

Table.4 THERMAL PARAMETERS

Construction	Area (m ²)	Proportion	Heat transfer coefficient (W/(m ² K))	Thermal inertia index
Gross floor area	1001	0.60	0.24	3.67
Column	128	0.08	0.39	2.17
Beam	380	0.23	0.39	2.17
Lintel	81	0.05	0.39	2.17
Floor	76	0.05	0.39	2.17
Total	1668	1	0.30	3.07

Energy System

2. Building

2.2 Energy Systems

Different systems are used for the energy supply. Currently, electricity can be sourced from both the elevator-integrated power generation system and the public grid. Air conditioner (AC), mechanical ventilation with heat recovery system and hot water system are ceiling-mounted in every household. Independent metering and online payment available.

Heating & Cooling System

- As the building is super energy-saving, the AC load is reduced by 80%-90% and the AC ductwork is reduced by more than 70%.
- The building is heated and cooled via AC and mechanical ventilation with heat recovery system. Every household is equipped with an AC, adjusting temperature as desired.

Electrical Power Supply

Electricity consumption is currently covered by the public grid and elevator-integrated power generation system. The building will also be able to generate electricity in the future by installing a rooftop PV system. The electricity demand is made up of the household electricity demand and the electricity demand for the building services.



Fig.5 AC, AND MECHANICAL VENTILATION WITH HEAT RECOVERY MODULAR CONSTRUCTION



Fig.6 ROOFTOP PV SYSTEM

Table.5 ENERGY EFFICIENCY CALCULATIONS
(BASED ON THE CASE OF A 135 m² UNIT)

Cooling Demand in Summer	23.6 kWh/m ² a
Heating Demand in Winter	6.3 kWh/m ² a
Electricity Consumption	11.3 kWh/m ² a

Resilient Cooling

Table.6 STRUCTURE OF THE SYSTEM

1. Reducing heat loads to people and indoor environments	
1.1.	Advanced solar shading
1.2.	Advanced cool materials
1.3.	Advanced glazing technologies
1.4.	Ventilated façades
1.5.	green roofs, green façades
2. Removing heat from indoor environments (production, emission and combined)	
2.1.	Ventilative cooling
2.2.	Thermal mass utilization
2.3.	Evaporative cooling
2.4.	Sky radiative cooling
2.5.	Compression refrigeration machines
2.6.	Adsorption chillers
2.7.	Natural heat sinks
2.8.	Radiant Cooling
3. Increasing personal comfort apart from space cooling	
3.1.	Comfort ventilation and elevated air movement
3.2.	Micro-cooling and personal comfort control
4. Removing latent heat from indoor environments	
4.1.	Dehumidification

3. Resilient Cooling

3.1 Principles

To reduce heat gains to indoor environments and the influence on people indoors. Holon building mainly adopts 5 mitigation measures:

- 22 cm rock wool for exterior walls
- 3 or 4-paned glass windows
- Exterior shade
- Interior shade
- Fresh air heat recovery

22cm rock wool
for exterior walls

3 or 4-paned
windows

Exterior shade

Interior shade

Fresh air heat
recovery

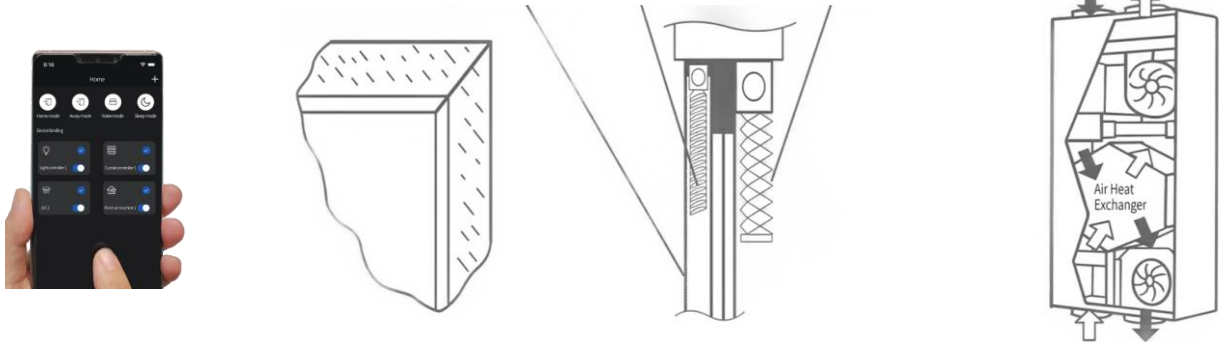

Fig.7 BBA INTELLIGENT CONTROL SYSTEM, THERMAL INSULATION MEASURES, AND FRESH AIR MACHINE

3.2 Technology

- When the sun shines into rooms in summer, the exterior sunshade will go down automatically (the exterior shade is equivalent to a concrete wall of 2 m thick). If the exterior sunshade is opened manually, the exterior sunshade will be closed automatically after 2 hours
- When there is no one in rooms in the hot season, or when people are sleeping (after turning off the lights at night) and the outdoor air temperature is higher than 30 °C, the interior shade will go down automatically
- Every household is equipped with an AC, adjusting temperature as desired
- When a room is vacant, the light, AC, and ventilation system will be off automatically within 1 hour
- The AC and ventilation system will be automatically off after opening windows or balcony doors within 30 minutes
- The mechanical ventilation with heat recovery system is equipped with a high-efficiency heat exchanger, which can recover 80% of exhaust heat. The temperature difference between the fresh air and the room air is around 2 °C

Resilient Cooling

3.3 Control Strategy Overview

Table.7 INTELLIGENT CONTROL QUICK CHECKLIST

No.	Intelligent Requirements	Setting Method	Description
1	Mobile network control	Scan the QR code to download the APP	Remote control of curtains, lighting, air conditioning, ventilation equipment, view all kinds of abnormal and alarm information
2	Alarm of overflow in toilet	Auto	The cloud server, APP and community security system are reported, and the APP displays the information of "toilet leakage"
3	Alarm on balcony door flooding	Auto	The cloud server, APP and community security system are reported, and the APP displays the information of "balcony door leakage"
4	Alarm of opening the window in rainy days	Auto	The APP displays the information "The window or door has been opened, the AC and ventilation system has stopped". After 30 minutes, the AC and ventilation system will stop
5	IAQ monitoring	Air monitor	The air monitor automatically monitor particulate matter, CO ₂ , electromagnetic radiation and ultraviolet rays, etc.

Resilient cooling control strategy

Table.8 ENERGY-SAVING CONTROL QUICK CHECKLIST

No.	Status	Setting Method	Description
1	The sun shines on the window in summer	Close the exterior sunshade	If the sunshade is opened manually, it will be closed automatically after 2 hours.
2	The sun shines on the window in winter	Open the exterior sunshade	If the sunshade is closed manually, it will be opened automatically after 2 hours.
3	Cold and hot	Turn off the interior shade at night after turning off the lights	Outdoor air temperature < 14 °C or >30 °C.
4	AC mode	Prevent misoperation	Outdoor air temperature < 10 °C, cannot be cooled; Outdoor air temperature > 30 °C, cannot be heated.
5	Doors and Windows open	Automatically stop AC and ventilation system after 30 minutes	The APP displays the information "The window or door has been opened, the AC and ventilation system has stopped".
6	The living room is unoccupied	Automatically stop AC and ventilation system after 30 minutes	Give the bedroom more fresh air
7	The house is unoccupied	Automatically stop AC, ventilation system and sunshade after 2 hours	Set "intermittent AC, fresh air" mode

4. KPI Evaluation

4.1 Thermal Comfort KPIs

Hours of exceedance HE

4h/week

Hours outside the range of Category II ($-0.5 < PMV < +0.5$)

Indoor Overheating Degree IOD

0.116 °C

Hourly summation of the positive values of the difference between the operative temperature of the occupied zones and the limit temperature for thermal comfort, divided by the sum of the zonal occupied hours.

Ambient Warmness Degree AWD

13.8 °C

Hourly summation over the summertime period of the positive values of the difference between the outdoor air temperature and a fixed base temperature (18 °C), divided by the total number of building occupied hours.

Overheating Escalation Factor OEF

0.008

An indicator of the resistivity of a building to climate change and associated overheating risk.

4.2 Heat Stress KPIs

Standard Effective Temperature SET

28.2 °C

The equivalent dry bulb temperature of an isothermal environment at 50% relative humidity, still air and 50% relative humidity, in which a subject, while wearing clothing standardized for activity concerned, would have the same heat stress and thermoregulatory strain as in the actual test environment.

Passive Survivability

Yes (hourly)

Ability to maintain safe indoor thermal conditions in the absence of active cooling

4.3 Energy

Weekly cooling site energy use intensity

0.6 kWh/(m²· a week)

Performance Evaluation

5. Performance Evaluation

5.1 Outdoor meteorological parameters during the monitoring period

Figure 8 shows the outdoor air temperature and relative humidity during one week in summer from July 26, 2022, 12:00 to August 2, 2022, 12:00.

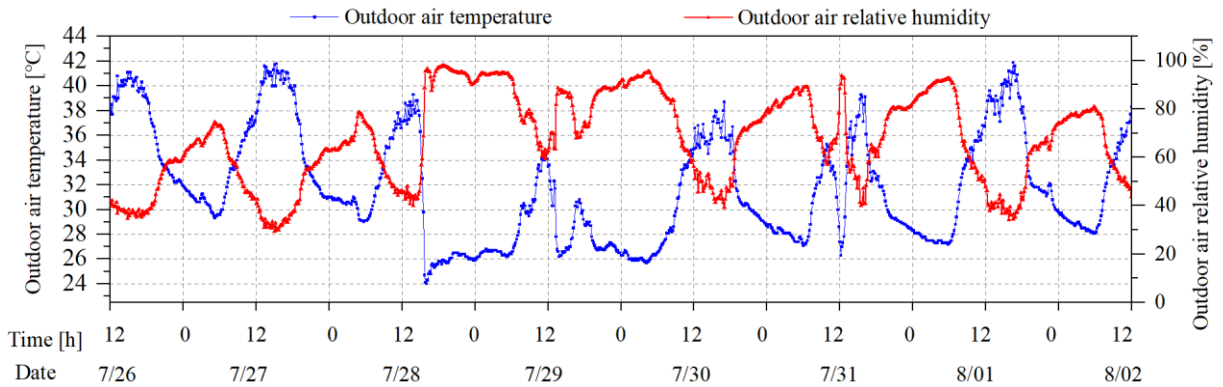

Fig.8 OUTDOOR METEOROLOGICAL PARAMETERS DURING THE MONITORING PERIOD

5.2 Power consumption

The case of the north-facing room on the second floor is taken as an example, which has an area of about 60 m². Figure 9 shows the monitored rooms layout. The building is cooled exclusively by split AC. The total electricity consumption in the measurement period July 26 - August 2, 2022 is around 38 kWh, and the power consumption per square meter is 0.6 kWh. The monitored power consumption is determined based on a fixed fresh air volume of 1 ACH.



Fig.9 THE NORTH-FACING ROOM FOR MONITORING

5.3 Power consumption and benchmarks

A traditional building is used as a benchmark case for comparison, which was built in 2009. The building is the Sunshine 100 Teachers' Residence in Changsha. The blue shaded part is not in the scope of this monitoring, and the monitoring area is 90 m². The whole set of rooms are cooled exclusively by split AC. The total electricity consumption of the areas in the measurement period is around 325 kWh, and the power consumption per square meter is 3.6 kWh.

The AC energy consumption of the Holon building is 16% of that of the monitored traditional building.

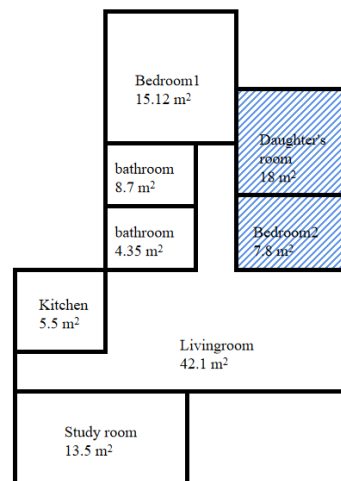

Fig. 10 BENCHMARK CASE, BENCHMARK CASE

Performance Evaluation

5.4 Comfort monitoring

Comfort monitoring was performed in the bedrooms and living room of the monitored apartment :

Figure 11 shows the dry-bulb air temperature, relative humidity, and operative temperature of the monitored rooms as box plots. The colored field delimits the range between the first and third quartile, and the lines show the range between the minimum and maximum value.

In general, it can be stated for all monitored rooms that the comfort parameters during the monitoring period are mostly in the comfortable range. The inner surface of the exterior wall has no obvious correlation with the outdoor air temperature and is close to the indoor air temperature, and the median temperature of the inner surface is 0.6 °C higher than the median indoor air temperature, as presented in Figure 12.

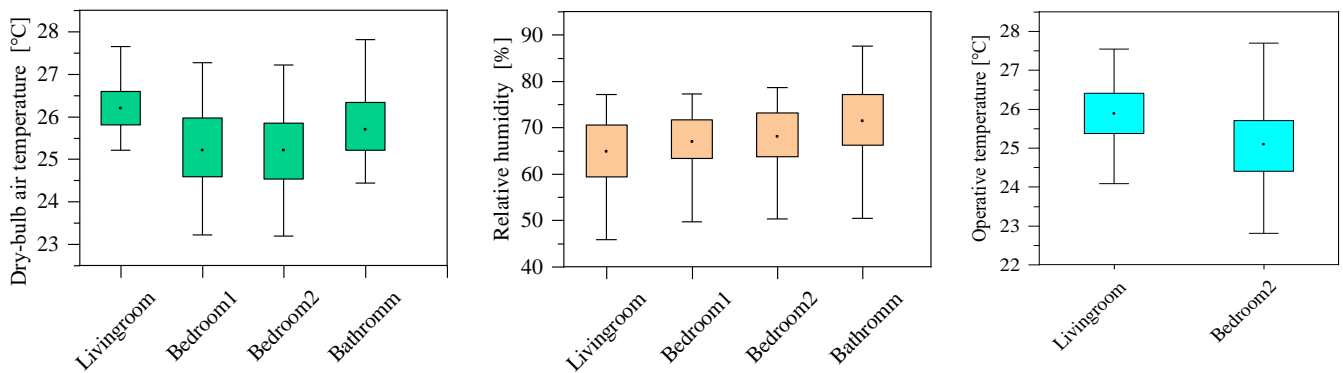

Fig.11 DRY-BULB AIR TEMPERATURE, RELATIVE HUMIDITY, AND OPERATIVE TEMPERATURE, GARDEN A-1 PROJECT

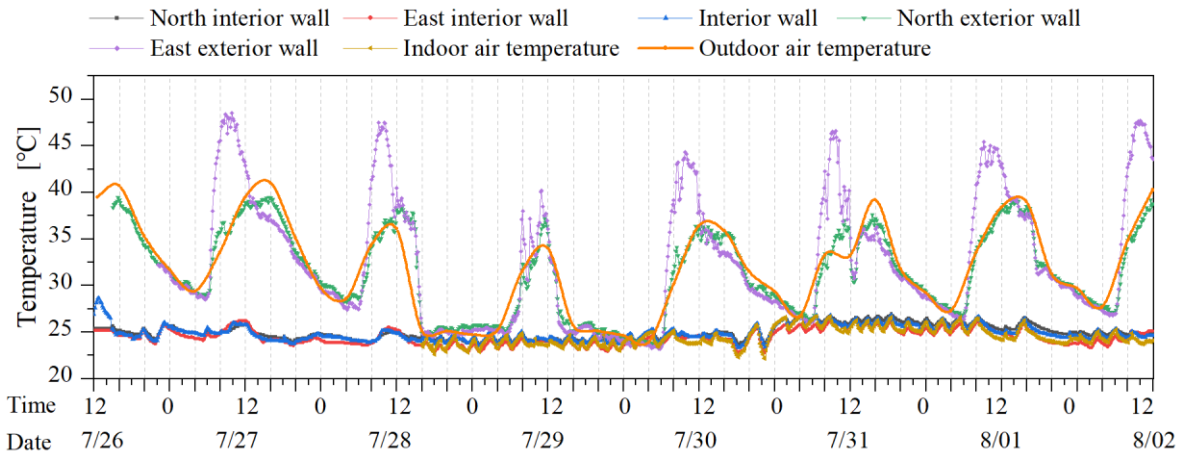

Fig.12 WALL SURFACE TEMPERATURE, GARDEN A-1 PROJECT

5.5 CO₂ monitoring

Figure 13 shows the CO₂ concentration of the reference areas as a box plot. The blue field delimits the range between the first and third quartile, and the lines show the range between the minimum and maximum value.

The fresh air rate is set to 1 ACH by the mechanical ventilation system. Throughout the monitoring period, the indoor air quality of this apartment remained satisfactory, with CO₂ concentration maintained below 700 ppm.

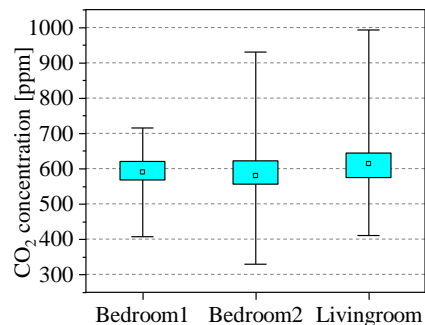

Fig.13 CO₂ CONCENTRATION, GARDEN A-1 PROJECT

6. Discussion, Lessons Learned

6.1 Summary

Five mitigation measures were used in this project: 22 cm rock wool for exterior walls, 3 or 4-paned glass windows, exterior shade, interior shade, and mechanical ventilation with heat recovery. The insulation measures, together with high-efficient ventilation system, enabled the Garden A-1 building to have only 16% of energy consumption, when compared to a traditional residential building.

6.2 Optimisation potential

Reduction of cooling energy demand

- By improving the performance of the exterior wall and window and improving the air tightness, it is possible to save cooling energy in the summer.
- By controlling shading facilities, a large reduction in heat gain of the building can be achieved.

Increasing energy efficiency by regulating the operation of fresh air

- The mechanical ventilation with heat recovery in the Holon building can automatically control the indoor CO₂ concentration via the AI control system, which can further reduce the cooling energy consumption.
- The control of mechanical ventilation with heat recovery can be done by the users for air volume adjustment and CO₂ concentration control (AI control system). In case of improper operation by the user, it would easily cause overheating in the flats and waste of energy in summer, and there should be an integrated guiding framework for terminal user control and centralized control.

References & Key Contacts

7. References & Key Contacts

7.1 References

- [1] ASHRAE, ANSI/ASHRAE Standard 169-2013, Climatic Data for Building Design. Atlanta: ASHRAE, 2013.
- [2] Weather China. (2023). <http://www.weather.com.cn/cityintro/101250101.shtml>
- [3] Ministry of Housing and Urban-Rural Development of the People's Republic of China GB/T 51350. (2019). Technical standard for nearly zero energy buildings. China Architecture Publishing & Media Co., Ltd.

The Holon building won the First Prize in the world World Modular Building Institute's Annual 2022 in US, and the Global Innovation Awards in the 2022 Council on Tall Buildings and Urban Habitat Global Awards, and the Third Award in the 2022 BRICS Industrial Innovation Contest.



7.2 Key Contacts

BROAD HOLON CO., LTD
<http://www.broad.com/>
Tel: 0731-84086558
E-mail: bsbs@broad.net



Introduction & Climate

1. Introduction & Climate

1.1 Introduction

The Rajkot Municipal Corporation is the developer of the project, which comprises 11 residential towers with 1,176 dwelling units, and a total area of 57,408 square meters. The project is called Smart GHAR III for ‘Green Homes at an Affordable Rate’. Achieving the policy goal of providing comfortable indoor temperatures at low cost and with minimal climate impact is a significant challenge in India’s hot climate. Smart GHAR III served as a pilot to demonstrate affordable residences with thermal comfort and low energy consumption. The city collaborated with experts from the Indo–Swiss Building Energy Efficiency Project (BEEP) to analyse land characteristics where new units would be built, and to identify how temperatures could be lowered to increase indoor comfort and facilitate low energy use.



Fig.1 EXTERIOR VIEW

1.2 Local Climate

Location: Rajkot, 22.3039° N, 70.8022° E

Climate Zone: The local climate is classified as composite climate in India. The temperature is very mild in winter, but very hot and dry in summer. ASHRAE climate zone 0B.

Climate Zone	Description
0A	Extremely Hot Humid
0B	Extremely Hot Dry
1A	Very Hot Humid
1B	Very Hot Dry
2A	Hot Humid
2B	Hot Dry
3A	Warm Humid
3B	Warm Dry
3C	Warm Marine
4A	Mixed Humid
4B	Mixed Dry
4C	Mixed Marine
5A	Cool Humid
5B	Cool Dry
5C	Cool Marine
6A	Cold Humid
6B	Cold Dry
7	Very Cold
8	Subarctic

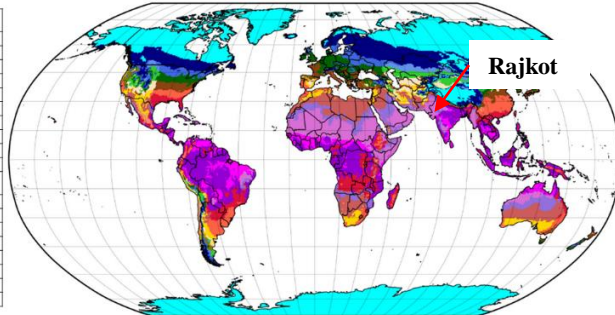
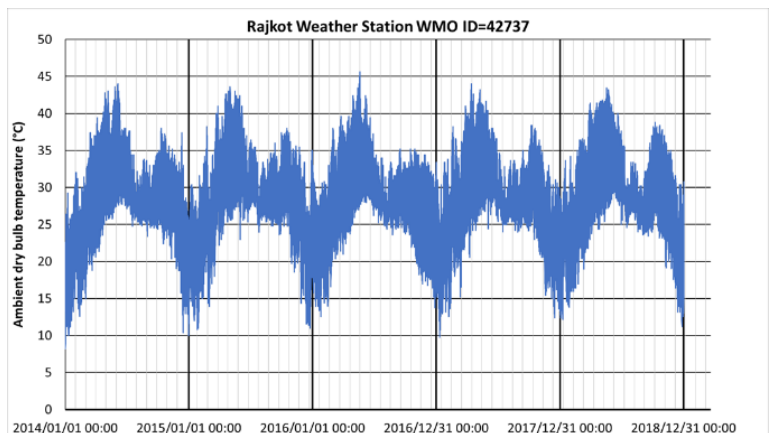

Fig.2 CLIMATE MAP (ASHRAE 169 - CLIMATE DATA FOR BUILDING DESIGN STANDARDS)

Table.1 KEY INFORMATION ABOUT THE BUILDING

Location	Rajkot, India
Building Type	Residential
Retrofit (Y/N)	N
Surroundings (Urban/Rural)	Urban
Year of Completion	2018
Floor Area (m²)	57,408
Building Volume (m³)	166,480
Window to Wall Ratio (%)	9%
Climate Zone	Composite (0B)
No. of Days with Te max > 25	361
Heating Degree days 12/20 (Kd)	~0

Fig.3 THE HOURLY DRY BULB TEMPERATURE (2014 TO 2018)



Building Information

2. Building

The building was designed with the main objective to reduce peak temperatures during the hot summer with only passive strategies.

2.1 Envelope and Construction

In comparison to common constructions, the walling has been designed using AAC blocks (Autoclaved Aerated Concrete blocks), allowing to reduce the U-value of walls from about 2 W/m²K to 0.7 W/m²K.

The window to wall ratio has also been reduced significantly by keeping some of the glazed area opaque, which significantly reduces the solar heat gains.

The windows have been designed to open outwards, helping to catch the wind to enter the apartment.

Table.2 INFORMATION PLANNING, OPERATION AND USE

Information on planning, operation and use	
Object use	Residential use
Integral planning process	Design charrette with dynamic simulations for the various strategies with follow-up for the detailing and execution. Building energy simulations (using EnergyPlus 8.3) were carried out to estimate the impact of the strategies on internal temperatures
Technical management	Follow-up with the Municipal Corporation (client)
Energy monitoring	Actual detailed monitoring of the passive performances of an apartment before occupation, followed by an occupancy survey

Table.3 BUILDING PROPERTIES

Property	Unit	Value
Hours of occupancy	h/week	168
Window U-value	W/(m ² K)	5.8
Window g-value	-	1/3 @ 0.85 2/3 are Opaque
Wall U-value	W/(m ² K)	0.7
Roof U-value	W/(m ² K)	1.2
Window to Wall Ratio	%	9%



Fig.4 EXTERIOR VIEW

Energy System

2. Building

2.2 Energy Systems

Apart from ceiling fans, which are generally installed by the dwellers, no other active system was planned or installed.

2.3 Design Simulation

2.3.1 Dynamic Simulation

The BEEP project held a design charrette to assist in the design of the new project (2016). During the workshop, different strategies were tested through dynamic simulation with the help of DesignBuilder/EnergyPlus.

At the design level, it was demonstrated that it was possible to achieve more than double the time that the temperature inside the apartments would be below 30 degrees.

Table.4 DYNAMIC SIMULATION RESULTS

Strategy (tested through simulation)	Hours above 30°C (Average all orientations)
1) Baseline: sliding windows	5,780
2) Casement windows	4,544
3) Casement windows partly opaque	3,519
4) Higher night ventilation rate (> 10 ACH during the night)	2,144

2.3.2 CFD Simulation

The CFD simulation of the airflow during hot summer nights showed that the air was passing almost parallel to the main facades, see Figure 5 below.

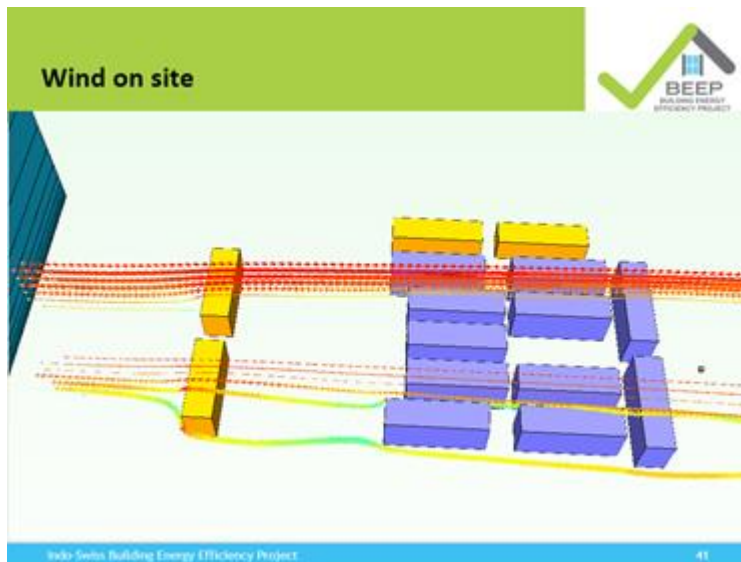

Fig.5 CFD SIMULATION: WIND FLOW

Energy System

2. Building

2.3.2 CFD Simulation

CFD simulations were performed to demonstrate the impact of the casement windows opening windward, which forces the air to enter the building. This increases the air change in the apartments.

Figure 6 shows the age of air in the bedrooms in two cases: a) top of the figure, without a special device to catch the wind along the facades. b) bottom of the figure, with a special window opening outwards and catching the wind. The age of air is reduced from almost an hour, in the first case, down to 8-10 minutes, in the second case, allowing a much better heat exchange for night driven wind cooling.

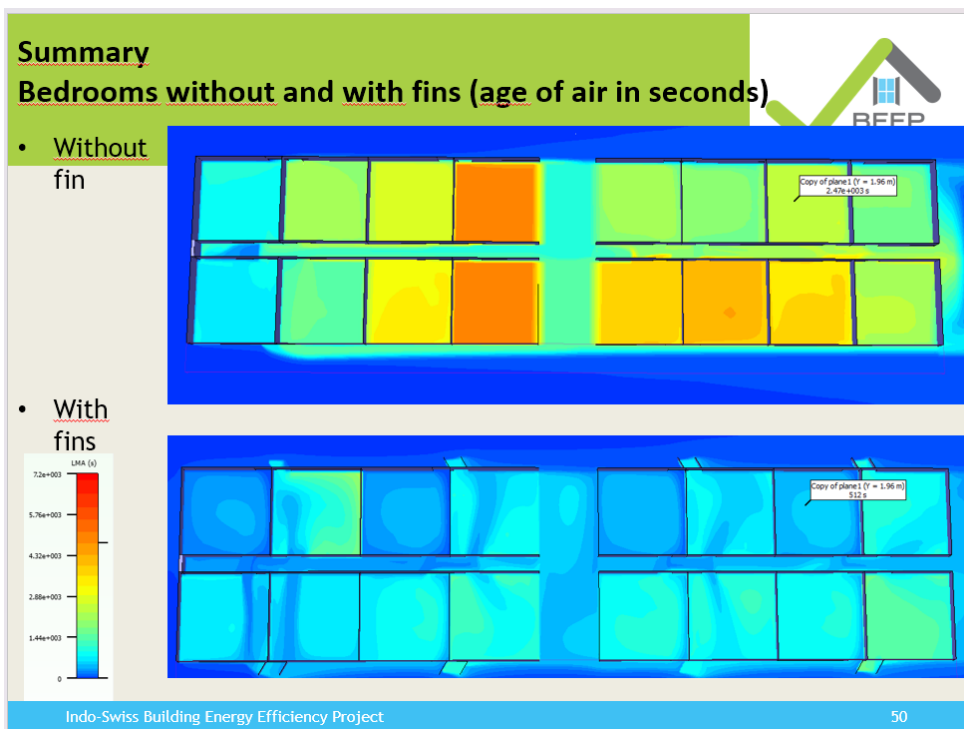

Fig.6 CFD SIMULATION: AGE OF AIR

Resilient Cooling

3. Resilient Cooling

The basis for resilient cooling in this project has been entirely based on passive means. It is generally assumed that less than 10% of the residential apartments in India are cooled actively. This design has been used as a template for many other projects in India.

3.1 Principles

As mentioned before, the main principle was to reduce the daytime heat gains through the building envelope and to maximally favor night cooling by natural ventilation with the highest possible efficiency by capturing the wind that passes along the facades to enter the apartments, and by installing ceiling fans in the dwelling units.

Table.5 STRUCTURE OF THE SYSTEM

<i>1. Reducing Heat Loads to People and Indoor Environments</i>	
1.1. Solar Shading Technologies	
1.2. Cool Envelope Materials	
1.3. Glazing Technologies	
1.4. Ventilated Façades	
1.5. Green Roofs and Green Façades	
<i>2. Reducing Heat Loads to People and Indoor Environments (Production, Emission and combined)</i>	
2.1. Ventilative cooling	
2.2. Thermal Mass Utilization	
2.3. Evaporative Cooling	
2.4. Sky Radiative Cooling	
2.5. Compression Refrigeration	
2.6. Adsorption Chiller	
2.7. Natural Heat Sinks	
2.8. Radiant Cooling	
<i>3. Increasing Personal Comfort Apart from Space Cooling</i>	
3.1. Comfort Ventilation and Elevated Air Movement	
3.2. Micro-cooling and Personal Comfort Control	
<i>4. Removing Latent Heat from Indoor Environments</i>	
4.1. Dehumidification	

KPI Evaluation

4. KPI Evaluation

4.1 Thermal Comfort KPIs

Hours of exceedance (HE) **2144 h/year**
Hours outside the range of 30°C

Indoor Overheating Degree IOD **0.38 C**

Hourly summation of the positive values of the difference between the operative temperature of the occupied building thermal zones and the zonal thermal comfort limit temperature (30 C), divided by the sum of the zonal occupied hours.

Ambient Warmness Degree AWD **9.8 C**

Hourly summation over the summertime period of the positive values of the difference between the outdoor air temperature and a fixed base temperature (18 C), divided by the total number of building occupied hours.

Overheating Escalation Factor OEF **0.039**

An indicator of the resistivity of a building to climate change and associated overheating risk.

4.2 Heat Stress KPIs

Standard Effective Temperature (SET) **26.6 C**

The equivalent dry bulb temperature of an isothermal environment at 50% relative humidity, still air and 50% relative humidity, in which a subject, while wearing clothing standardized for activity concerned, would have the same heat stress and thermoregulatory strain as in the actual test environment.

Passive Survivability **Yes (hourly)**

Ability to maintain safe indoor thermal conditions in the absence of active cooling

4.3 Carbon dioxide (CO₂) emissions

Annual amount of CO₂ emissions **1500 gCO₂/m².a**

Annual electricity use for fans is 1.66 kWh/(m².a) and the carbon dioxide (CO₂) emissions factor for electricity is 0.9 kg CO₂/kWh.

Performance Evaluation

5. Performance Evaluation

5.1 Energy

The building is completely passive, only ceiling fans are used by the occupants. Therefore, no energy is used for the thermal comfort. Passive measures only.

5.2 Comfort

In India, a national thermal comfort model has been developed, the India Model for Adaptive Comfort (IMAC). It shows similar curve as the ASHRAE 55 or ISO 16798 thermal comfort, but with a stronger slope. Which means that the thermal comfort band is significantly higher than the ASHRAE or ISO standards. See figure 7 below: Comparison between (graph A) the IMAC-R (residential), IMAC (MM) (mixed mode), IMAC (NV) and ASHRAE-55 standard and (graph B) IMAC-R (residential) and the ISO EN 16798-1 standard.

During the design charrette, the results showed that that increase in natural ventilation by casement windows opening outside, combined with lower glazed area brought significant increase of the number of hours below 30 °C inside.

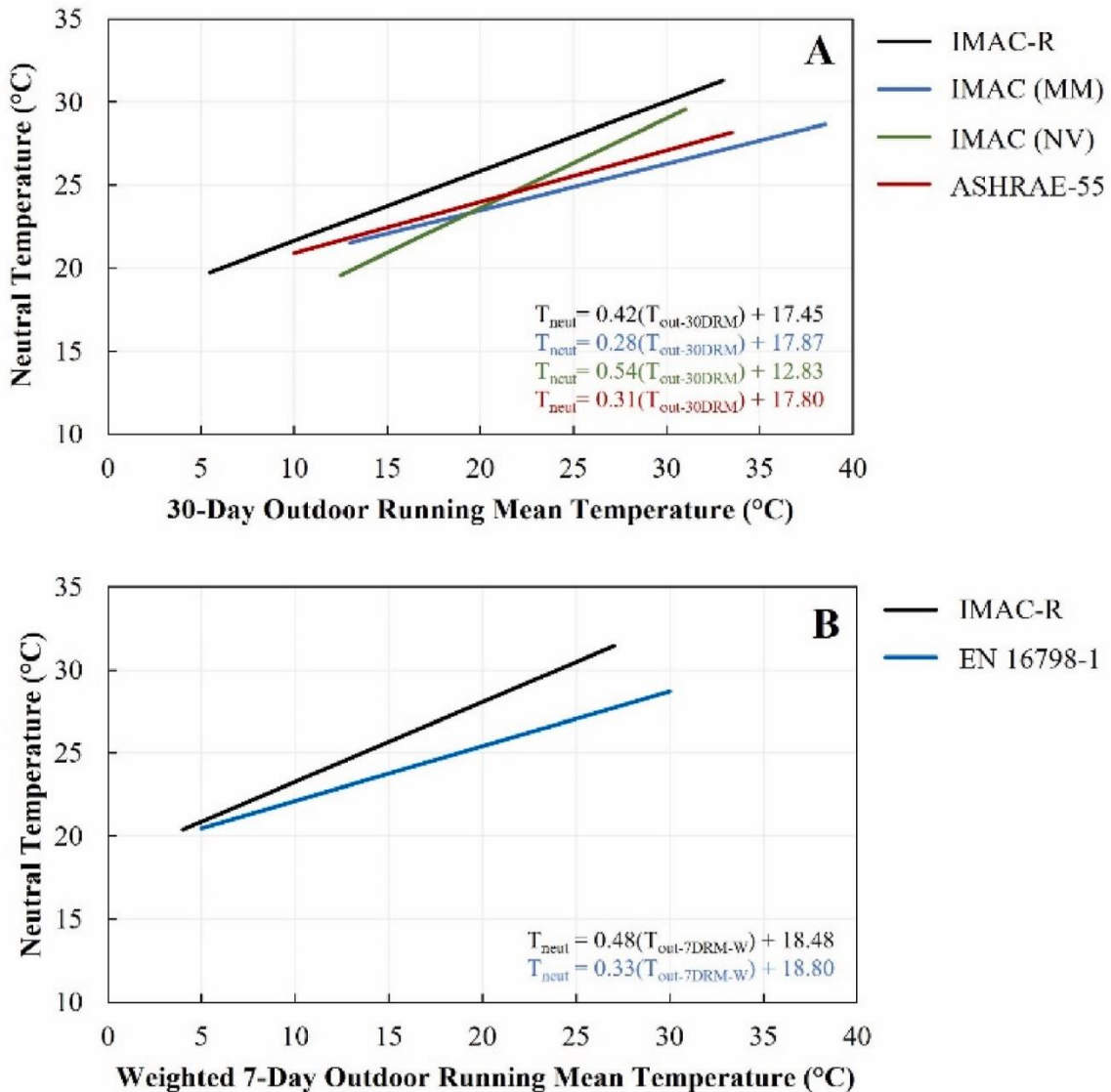

Fig.7 THE INDIA MODEL FOR ADAPTIVE COMFORT

Performance Evaluation

5. Performance Evaluation

5.2.1 Measurement before occupation in a test apartment

One measurement campaign was conducted before occupation. The actual measurement before occupation confirmed the results obtained during the design. With a maximum outside temperature of 39 to 40 °C, the temperature in the test bedroom does not exceed 33 °C, which is within the in 90% acceptance of the IMAC comfort zone (see section 5.2.2), so about 8 °C below the peak ambient temperature without any cooling.

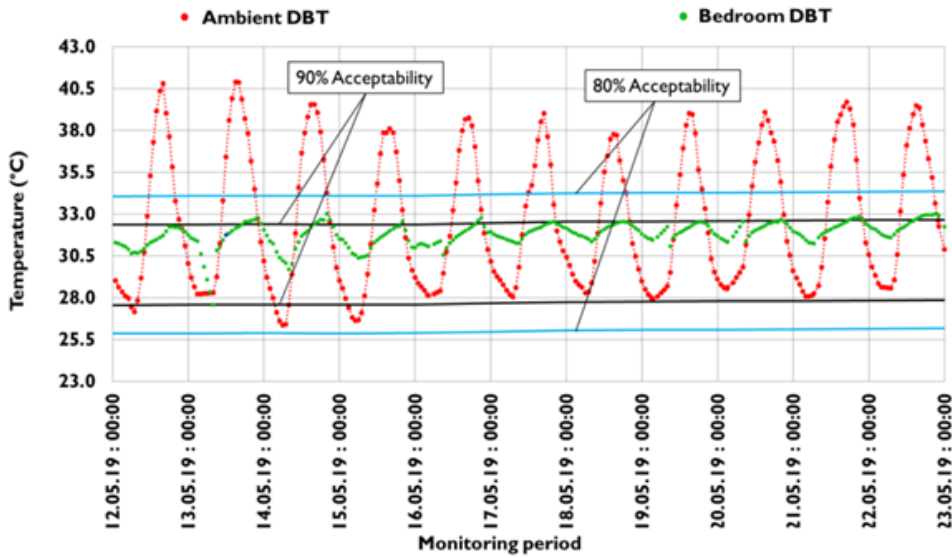

Fig.8 ACTUAL BEDROOM TEMPERATURE MEASURED IN THE TEST FLAT OVER A PERIOD OF 10 DAYS

5.2.2 Study and survey after the occupation

A post occupancy survey was carried out by CARBSE of CEPT University in 2023. The following results have been obtained from the survey. The general conclusion is that the thermal comfort in summer was generally perceived as acceptable temperatures.

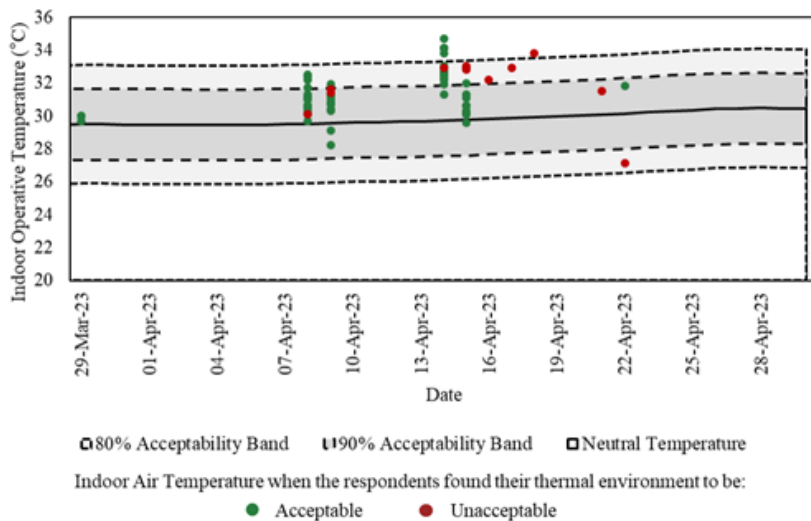

Fig.9 RESULTS OF POST OCCUPANCY SURVEY

Lessons Learned

6. Discussion, Lessons Learned

6.1 Summary

The buildings were designed with the intention to provide acceptable thermal comfort in the apartments. The results met the design expectations. Final testing of the finished GHAR III showed that indoor temperature peaks decreased by 6 °C, and the number of hours the temperature remained below 30 °C increased, improving the quality of life for 1,176 families.

Even in hot climates, it is possible to offer reasonably acceptable thermal comfort for people accustomed to the climate. However, this is only possible if people use ceiling fans in their homes.

6.2 Optimisation potential

1. The design team's initial concept was to use a variable volume flow controller in each flat. However, this proved too expensive and too complex to be sustainable. By reverting to a simpler and more robust solution of constant air flow, it was possible to achieve very low electric power consumption for ventilative cooling.
2. In addition to the fully passive solution described above, the project team had the opportunity to test another simple and energy efficient ventilation system, where air is drawn into a vertical shaft in the middle of 14 flats on 7 floors, see Figure 10 below. The system was designed to draw air from the flats in a balanced way with 12 air changes per hour and a power of 1.3 W/m² of floor area. The ratio of power on flow rate is of 0.515 kW/3.89 m³/sec = 0.13 kW/(m³/sec). The results showed that such a strategy allows very efficient cooling at night, significantly reducing the daytime peak temperature in the flats by about four degree Celsius compared to a baseline reference. However, the system was not implemented in the project.

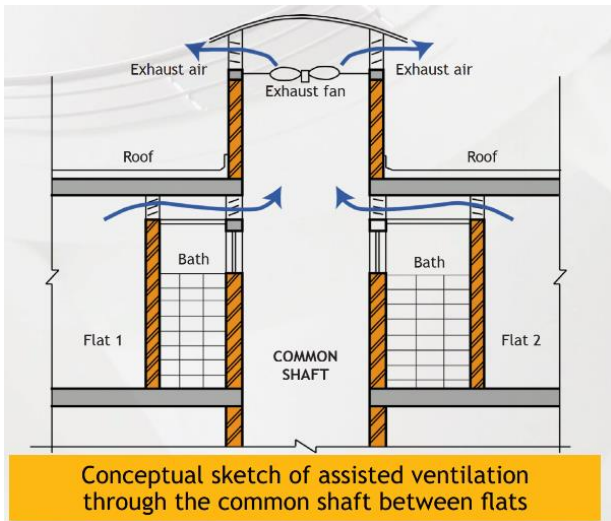

Fig.10 ADDITIONAL CONCEPT THAT WAS TESTED BUT NOT IMPLEMENTED

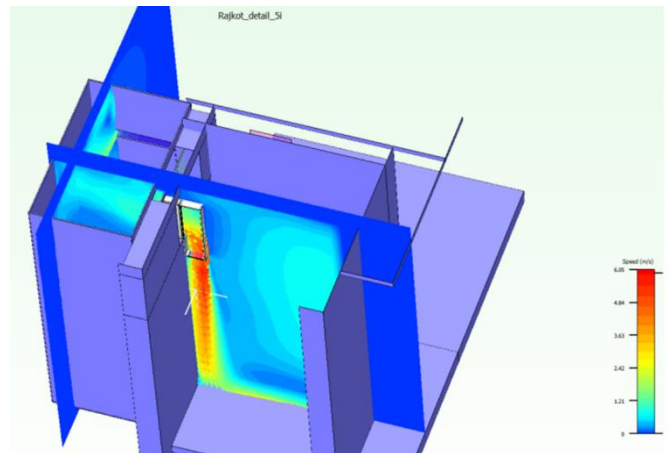

Fig.11 CFD SIMULATION OF THE ADDITIONAL CONCEPT

References & Key Contacts

7. References & Key Contacts

7.1 References

[1] ASHRAE, ANSI/ASHRAE Standard 169-2013, Climatic Data for Building Design. Atlanta: ASHRAE, 2013.

[2] Rawal, R., Shukla, Y., Vardhan, V., Asrani, S., Schweiker, M., de Dear, R., Garg, V., Mathur, J., Prakash, S., Diddi, S., Ranjan, S., & Somani, G. (2022). Adaptive thermal comfort model based on field studies in five climate zones across India. Building and Environment, 109187. <https://doi.org/10.1016/j.buildenv.2022.109187>

[3] Saswati Chetia, Sameer Maithel, Pierre Jaboyedoff, Ashok Lall, Prashant Bhanware, Akshat Gupta, Indo-Swiss Building Energy Efficiency, Project (BEEP), New Delhi, India, Energise 2020: Energy Innovation for a Sustainable Economy, India.

A CASE STUDY ON DESIGN OF THERMALLY COMFORTABLE AFFORDABLE HOUSING IN COMPOSITE CLIMATE: SIMULATION RESULTS & MONITORED PERFORMANCE

[4] Smart GHAR III Post Occupancy Evaluation: A Report on User Perception Survey in the Context of Thermal Comfort, 2023 may, Centre for Advanced Research in Building Science and Energy (CARBSE), CEPT Research and Development Foundation (CRDF), CEPT University

[5] <https://www.businessinsider.in/business/news/air-conditioner-market-set-grow-on-the-back-of-governments-pledge/articleshow/99273122.cms>

[6] Integrated Design Charrette for Smart GHAR 3, Rajkot, Date: 27th – 29th September 2016
Venue: Rajkot Municipal Corporation, Indo-Swiss Building Energy Efficiency Project.
Conference paper at Energise 2020, India

7.3 Contacts

Company	Role	Contact
Effin'Art Sàrl	Associate	Pierre Jaboyedoff pierre.jaboyedoff@effinart.ch www.effinart.ch T. +41 21 616 11 00 M. +41 79 668 50 88

Introduction & Climate

1. Introduction & Climate

1.1 Introduction

The Living Lab at the ENEA Casaccia Research Centre consists of seven rooms in the office building F40. The building was built at the end of the 1980s. It has three stories and hosts cellular office rooms plus some laboratories at the ground floor, a technological hall is attached to the building on the east side. The rooms of the Living Lab are on the first floor of the building, all of them with a single external façade west oriented, only one room has also a facade north oriented.



Fig.1 View of the building F40. The seven rooms of the Living Lab are those whose windows have the room air conditioner below.

Table.1 KEY INFORMATION ABOUT THE BUILDING

Location	Rome, Italy
Building Type	Office
Retrofit (Y/N)	Partially
Surroundings (Urban/Rural)	Rural
Year of Completion	80' of the past century
Floor Area (m²)	120 m ² (7 rooms each 17 m ²)
Building Volume (m³)	380
Openable Area to Floor Area Ratio (%)	19 %
Window to Wall Ratio (%)	26 %
Climate Zone	Csa , 3A
Average temperature during the hottest month	July: 26.4°C
Heating Degree days 12/20 (Kd)	1,450 in base 20°C

1.2 Local Climate

Location: The building is located in the northern outskirts of Rome (Coordinates 41° 53' 0" N, 12° 29' 0" E). It is a rural area, even if the Research Center itself consists of dozens of buildings and it is bordered by a small settlement (few hundred houses).

Climate Zone: The building is located in the Csa climate zone, corresponding to the Mediterranean climate, according to the Köppen-Geiger classification. It also belong to 3A zone according to the classification by ASHRAE.

Climate Zone	Description
0A	Extremely Hot Humid
0B	Extremely Hot Dry
1A	Very Hot Humid
1B	Very Hot Dry
2A	Hot Humid
2B	Hot Dry
3A	Warm Humid
3B	Warm Dry
3C	Warm Marine
4A	Mixed Humid
4B	Mixed Dry
4C	Mixed Marine
5A	Cool Humid
5B	Cool Dry
5C	Cool Marine
6A	Cold Humid
6B	Cold Dry
7	Very Cold
8	Subarctic

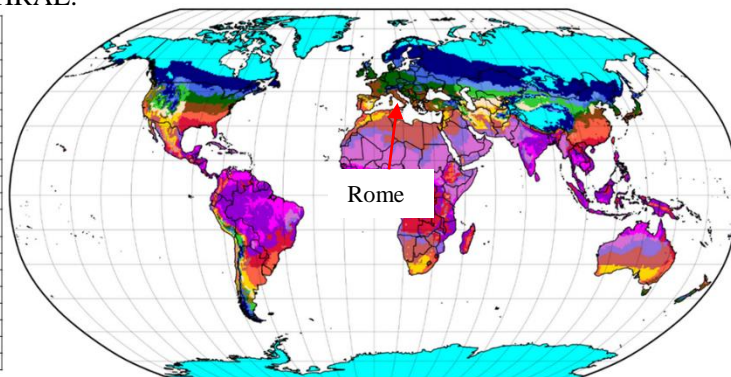

Fig.2 CLIMATE MAP (ASHRAE 169 - CLIMATE DATA FOR BUILDING DESIGN STANDARDS)

Building Information

2. Building

2.1 Envelope and Construction

The building has the façade made of brick double layer with thermal insulation in between and initial $0.50 \text{ W/m}^2\text{K}$ thermal transmittance. Being the Living Lab at the intermediate floor, the thermal transmittance of ground floor and roof is irrelevant. With reference to the figure below, three type of windows are installed:

- W1 (Room 5-7) - original double glazing units with no-thermal break aluminium frame and external dark blind for solar control.
- W2 (Room 3 & 4) - low-emissivity selective double glazing unit with frame in aluminium with thermal breaks; one sash can be electrically opened/closed by a push button mounted in place of the handle or by a remote management system.
- W3 (Room 1 & 2) - low-emissivity selective triple glazing unit with same frame than W2.

W2 and W3 have venetian blinds inside the glazing gap, which can be remotely controlled by an automated management system. The g-values of the glazing systems are 0.79, 0.36 and 0.31 for W1, W2 and W3, respectively, while the U-values of the windows are 2.9, 1.4 and $1.1 \text{ W/m}^2\text{K}$, respectively.

The windows were provided by Schüco Italia srl and the glazing systems by Pellini spa

Table.2 INFORMATION PLANNING, OPERATION AND USE

Information on planning, operation and use	
Object use	Office and Laboratory
Integral planning process	Existing building, not applicable
Technical management	Managed by the ENEA Service in charge of the building stock maintenance
Energy monitoring	Smart energy monitoring and management system managed by the ENEA Smart Energy Division

Table.3 BUILDING PROPERTIES

Property	Unit	Value
Hours of occupancy	Hours per day	7.5
Window U-value	Wm^2K	1.1-2.9
Window g-value	-	0.31-0.79
Wall U-value	$\text{W/m}^2\text{K}$	0.50
Roof U-value	$\text{W/m}^2\text{K}$	Not applicable
Floor U-value	$\text{W/m}^2\text{K}$	Not applicable
Window to Wall Ratio	%	26

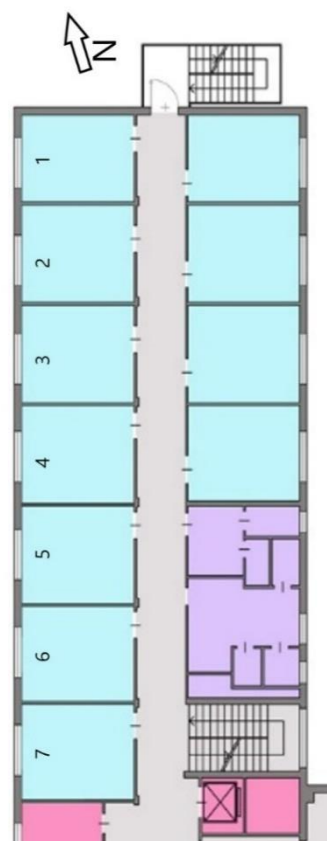

Fig.3 LAY-OUT OF THE ENEA LIVNG LAB

2. Building

2.2 Energy Systems

The whole building has pipes and fan-coils in each room to circulate hot and refrigerated water in winter and summer, respectively. The heating is supplied by a thermal power plant that circulates high temperature water for all the buildings of the Research center. The cooling is supplied by a local electric compression chiller. Both systems are old and the installed piping system is in poor conditions. To ensure ease of monitoring and improve the cooling energy performance, new room reversible air conditioners (AC) were installed in the seven rooms of the Living Lab. The AC unit cooling and heating power is 2.5 and 3.4 kW, respectively.

Table.4 PERFORMANCE OF THE AIR CONDITIONING UNITS

COP	3.74
SCOP	4.2
Energy efficiency class	A+
EER	4.03
SEER	6.2
Energy efficiency class	A++



Fig.4 VIEW OF A TESTING ROOM, THE DYNAMIC WINDOW AND THE INTERNAL UNIT OF THE EC SPLIT SYSTEM

2.2.1 The PV plant and the electric storage

The F40 building has a PV plant mounted on the roof and an electric storage of lithium batteries. In the current configuration, the renewable system provides energy to all the building. Planned activities focus on the integration of this system only to feed the seven rooms of the Living Lab.

The objective is to assess the overall performance not only in terms of energy uses, rather on other relevant aspects, such as: resilience, flexibility, energy sufficiency.

No actions were however carried out in the framework of IEA-EBC Annex 80.

2.2.2 The Smart Energy Management System

The Living Lab is fully monitored and managed by a smart energy system. The services under its control are the meteorological station on the roof, the PV plant and the electric storage, the heating and cooling, as well as the lighting system, the room environmental conditions (air temperature and relative humidity, illuminance, CO₂ concentration, presence), the activation of the solar shading and sash opening of the new windows.

The systems is implemented with many micro-apps, each of them with a specific control and monitoring task, able to dialogue each other, so that a specific rule can involve several apps.

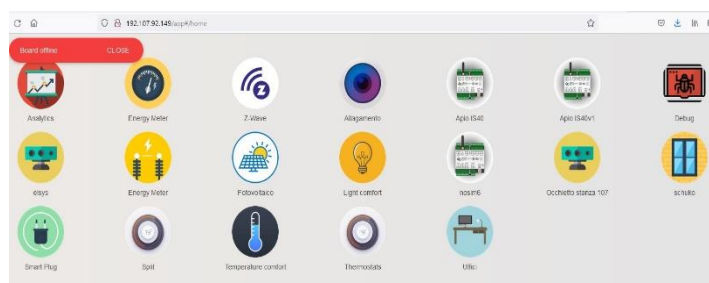

Fig.5 DASHBOARD OF THE SMART ENERGY MANAGEMENT SYSTEM

3. Resilient Cooling

3.1 Principles and aims of the pilot study

The Living Lab was implemented to test building, energy and smart technologies in a real working environment. Thus this building is not new, neither fully renovated. The installation of the new windows and of new highly efficient room air conditioning units gave, however, the chance to study the impact of advance envelope solutions in comparison with the standard existing ones, thanks to the automated control of dynamic shading system and the night flush ventilation, as well as of advance glazing systems.

In this perspective, this is mainly a tailored comparative field study among similar rooms with different equipment's rather than a long term monitoring of a whole building; in particular between rooms from 1 to 4 with advance new windows and the rooms 5 to 7 with the original old windows still installed.

3.2 Structure of resilient cooling technology

The management of the dynamic windows carried out applying different strategies in the different monitoring periods, which will be indicated in the results section.

3.2.1. Reduce the external heat gains

Advanced glazing systems

The original windows have a g-value of 0.79, which means high solar gains in the afternoon during the intermediate and summer periods, in addition the low thermal transmittance causes heat gains during the hot hours of the day in those periods. The new glazing systems (double and triple) thanks to the low-emissivity selective coating exhibit much lower g-values (0.36 and 0.31 respectively). The multiple glazing systems also provide high insulation level that is positive during the hot period but may enhance the indoor overheating, because of lower heat losses during the cooler hours. for W1, W2 and W3

Advanced solar shading systems

The new windows, installed in rooms 1 to 4, have venetian blinds placed in the gap of the multiple glazing units. The lamellae are opaque and with solar reflectance 0.71 and 0.68 for the window W2 and W3, respectively. Even if not performing as the external shading devices, the high reflectance of the lamellae and the good selectivity of the glazing ensure high solar protection performances.

The shading devices are activated dynamically in the afternoon when the direct solar irradiation becomes intense on west-oriented facades, or through the whole day to minimize the energy use. The activation took place by either simple time scheduling or when the solar global irradiation was in a given range. In the latter case, blind pulled down where the solar irradiation reached 150 W/m² and retracted when the solar irradiation dropped below 100 W/m², the hysteresis were introduced to avoid continuous switching up and down of the shading that would have made the management via the smart energy management systems complicated.

Table.5 STRUCTURE OF THE SYSTEM

1. Reducing Heat Loads to People and Indoor Environments	
1.1. Solar Shading Technologies	
1.2. Cool Envelope Materials	
1.3. Glazing Technologies	
1.4. Ventilated Façades	
1.5. Green Roofs and Green Façades	
2. Reducing Heat Loads to People and Indoor Environments (Production, Emission and combined)	
2.1. Ventilative cooling	
2.2. Thermal Mass Utilization	
2.3. Evaporative Cooling	
2.4. Sky Radiative Cooling	
2.5. Compression Refrigeration	
2.6. Adsorption Chiller	
2.7. Natural Heat Sinks	
2.8. Radiant Cooling	
3. Increasing Personal Comfort Apart from Space Cooling	
3.1. Comfort Ventilation and Elevated Air Movement	
3.2. Micro-cooling and Personal Comfort Control	
4. Removing Latent Heat from Indoor Environments	
4.1. Dehumidification	

3.2.2 Removing heat from the indoor environment

Ventilative cooling

The strategy is carried out thanks to the opening of the motorized sash of the advanced windows in the rooms 1 to 4. The fresh area inlet depends on the sash aperture, whose angle can be maximum 30 degrees with respect to the fully closed position. This is a strong limitation, intrinsic of the installed window technology. Due to the quite low wind regime during the monitoring period, the air exchange is mainly driven by the buoyancy effect. Some punctual tests were run and it was found out that the inlet of fresh air at night was in the 1-1.5ACH range.

The activation of the night opening was managed according to a time schedule, typically from 21:00 until 08:00 of the next morning, or according to the difference between the indoor and outdoor temperature. In the latter case, the sash opened when such difference exceeded 3°C and closed when dropped below 1 or 2°C, depending on the monitoring period.

High performance compression chillers

As already described in the previous section, the seven rooms of the Living Lab were equipped with high performance (EER > 4) room air conditioning units, also operating as heat pumps in winter. During the monitoring with the active cooling, all the rooms had 26°C as sensible heat set-point; the relative humidity had no fixed set-point, however the cooling circuit ensured humidity level in the range of 50-55% as detected by the indoor environmental sensors.

4. KPI Evaluation

Due to the short time monitoring of the Living Lab and to the fact that the building was often managed with the active cooling units, being in line with the objective of the study, the Key Performance Indicators are not relevant in this case, as they should refer to an entire season in free cooling conditions.

However, a thermal comfort analysis is provided under Section 5.2.

Performance Evaluation

5. Performance Evaluation

5.1 Energy

The energy performance of the Living Lab was evaluated through several monitoring slots in summer 2022. In such periods different scenarios were implemented for the night ventilation and the shading operations in rooms 1 to 4, while the shading systems were freely operated in rooms 5 to 7, equipped with the old windows.

The monitoring events were very specific in settings and duration, and they included periods in which the rooms were occupied or unoccupied. Trying to provide a wider view of the performance achievable with the advanced envelope solution, some aggregated results are here provided for the whole monitoring period in June and August

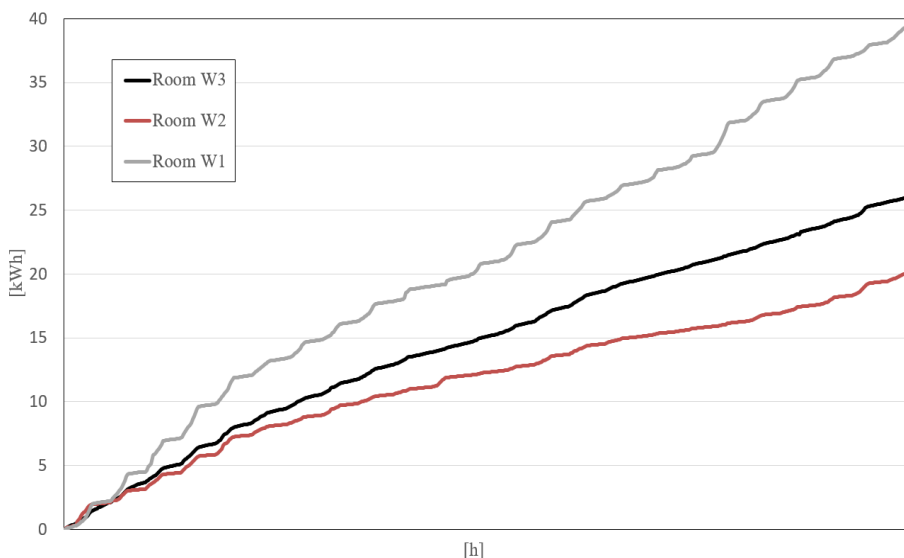

Fig.6 AVERAGE CUMULATIVE FINALE ENERGY USE IN THE ROOM WITH THE SAME TYPOLOGY OF WINDOWS : W3, TRIPLE WINDOW, W2 NEW DOUBLE WINDOW AND W1, OLD DOUBLE WINDOW IN AUGUST 2021.

Monitoring results

The air conditioning units were switched on between 8.00 and 18.00 whether the room was occupied or not. This was done to collect some significant data on the envelope performance during the period, getting rid of the restraints of the occupation patterns. The temperature set-point was 26°C, no direct control on the relative humidity was possible, even in post-occupation it was observed that it was in the 47-53% on average during operation.

Taking into account the whole monitoring period (2-22 of June and 4-27 of August) it was found out that the rooms equipped in the old windows used 40 kWh as cooling energy, while the cooling energy consumption dropped to about 20-25 kWh on average for both, the rooms equipped with W3 and W2. This behavior can be observed in Figure 6, where the cumulative energy use during the August monitoring period is reported, averaging the results obtained for the rooms with the same windows type with a very small difference among the two room categories. This implies that the rooms with new windows used 40-50% energy less the old original ones. Figure 7 shows the results during the June and August monitoring, also disaggregating the data by single and double occupancy of the rooms.

The results prove 27-40% cooling energy savings due to the night ventilation and the solar protection. The increase of energy uses in rooms with double occupancy with respect to them with single occupants (in the 14-60% range) stresses the relevance of the internal loads in shaping the cooling demand in office buildings.

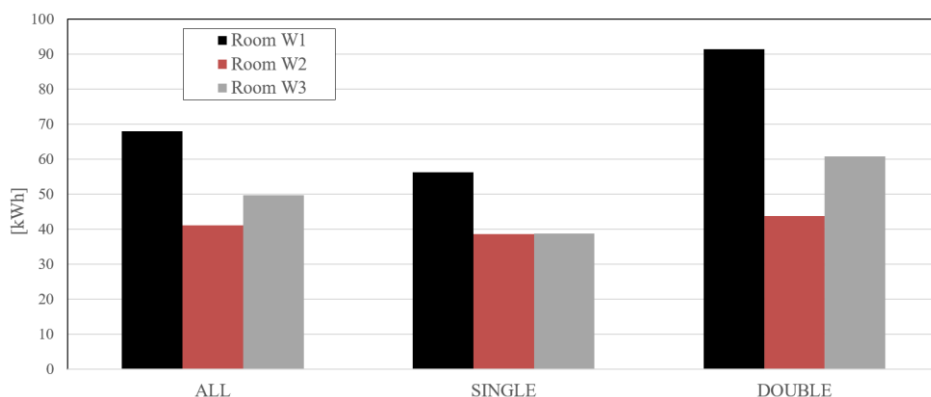

Fig.7 COOLING ENERGY USE IN THE LIVING LAB IN JUNE AND AUGUST 2022. THE RESULTS SHOW THE ENERGY BENEFITS OF SOLAR PROTECTION AND NIGHT VENTILATION, AS WELL AS THE ROLE OF INTERNAL LOADS, LINKED TO THE ROOM OCCUPANCY (SINGLE OR DOUBLE).

Performance Evaluation

5. Performance Evaluation

5.2 Thermal free cooling monitoring

Monitoring events of the Living Lab in thermal free cooling conditions (no active cooling in use) were run in summer 2020 and 2021. Due to the general objectives of the case study, the monitoring did not last enough to have a complete assessment of the different rooms in terms of the thermal comfort throughout the cooling season. This limitation caused the project to not be eligible for the key performance indicators defined in the Annex 80 activities. Conversely, the analysis of the results provided some insights about the potential of the selected technologies to mitigate the indoor built environment.

The analysis was made in this case across the 24 hours, without going into the details of the working hours. This was done for two main reasons: i) the June 2020 monitoring was carried out during the Covid19 pandemic, and the rooms were rarely occupied and with only one person allowed (see red cells in the table below); ii) the August 2021 was carried out during the summer break, so the building was unoccupied.

Table.6 DAILY AVERAGE TEMPERATURE IN THE LIVING LAB, JUNE 2020

Date	Tout	T_room1	T_room2	T_room3	T_room4	T_room5	T_room6	T_room7
8 June	20.4	26.0	26.6	27.0	27.8	29.4	27.9	27.2
9 June	19.3	25.8	26.7	27.3	27.2	29.4	27.9	27.6
10 June	18.1	25.8	26.7	27.3	27.2	29.4	27.9	27.6
11 June	16.0	25.0	25.8	25.4	26.5	28.6	27.3	26.9
12 June	19.1	24.9	25.8	25.8	27.0	28.0	26.5	26.1
13 June	19.9	24.1	24.6	24.4	25.4	27.6	26.4	26.0
14 June	20.5	24.2	24.8	24.6	25.6	26.8	26.3	26.4
15 June	21.6	24.5	24.8	24.9	26.1	26.9	26.7	26.8
16 June	21.9	24.9	25.0	25.5	26.4	27.5	27.3	27.3
17 June	21.3	25.6	25.6	25.8	26.7	26.9	27.2	27.6
18 June	20.9	25.6	25.8	26.0	26.4	27.4	27.5	27.7
T av	19.9	25.1	25.7	25.8	26.6	28.0	27.2	27.0
Tmin	16.0	24.1	24.6	24.4	25.4	26.8	26.3	26.0
Tmax	21.9	26.0	26.7	27.3	27.8	27.6	27.9	27.7

The shadings were activated in the afternoon in rooms 1 to 4; the external blinds in the rooms 5 to 7 were pulled down to the half. Night ventilation from 21:00 to 8:00 was on in room 1 to 4.

The daily temperature in rooms with window 1 was 2°C lower on average than that in rooms with original windows; the difference dropped to 1.2°C in rooms with window 2 type. This is mainly due to the anomalous high temperature in room 4, due to the higher temperature in the surrounding rooms a ground and top floor.

The presence of occupants increases the temperature by 0.5°C on average without significant variations among the rooms

The data was acquired with 15 minutes resolution step. The air temperature profiles evidence the impact of the new envelope technologies in lowering the indoor thermal conditions.

The window 1 and 2 types exhibit similar performance. this is expected because despite the double and triple glazing units have substantially different thermal insulation properties (being the triple more insulating), they have similar behavior in terms of solar control (the glazing systems and the integrated venetian blinds).

The plots show that the temperatures seldom reach 28°C in the rooms with new windows, whilst the values is peaked almost every day in room 6. In addition, the temperature peak 29°C in several days in the latter.

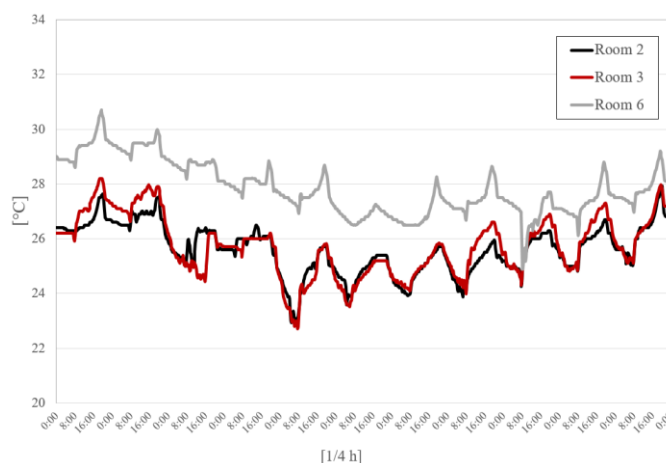

Fig. 8 15 MINUTE AIR TEMPERATURE PROFILE IN AN EXEMPLARY ROOM FOR EACH WINDOW TYPE

Performance Evaluation

5. Performance Evaluation

The thermal free cooling monitoring continued in August 2021, with the objective of comparing the performance of the new windows managed with different control rules, which are summarized in the table below. The rules refer to the activation of the venetian blinds and the night opening of the windows, everything done by the smart energy management system of the Living Lab. The shading activation is done by schedule or by global horizontal irradiation levels; the night ventilation by schedule or by difference between indoor and outdoor temperature. In case of control by physical parameters (such as external air temperature and solar irradiation), hysteresis is introduced to avoid continuous switch on/off of the elements.

The figure below refer to six exemplary days in August 2021 (from 15th to 20th). The results show that the temperatures in room 1 are higher than in the other three rooms, and this can be easily inferred to the fact that this is the only room without natural ventilation at night. The other three rooms exhibit similar temperature profiles, despite the different control rules. An interesting observing is that this applies also for room 4, where the shading system is never activated. The temperature profile in room 7 is presented for comparison against the old windows. The impact is easily inferred with peak temperature reduction well above 3°C during several days.

Table.7 CONTROL RULES FOR THE DYNAMIC ELEMENTS OF THE NEW WINDOWS

Room	Sash	Op/clos Rule	Blind	Op/clos rule
1	N	---	Y	$H > 150W/m^2$ $H < 100W/m^2$
2	Y	21:00 08:00 (next day)	Y	14:00 20:00
3	Y	$(T_{in} - T_{out}) > 3^{\circ}C$ $(T_{in} - T_{out}) < 2^{\circ}C$	Y	$H > 150W/m^2$ $H < 100W/m^2$
4	Y	$(T_{in} - T_{out}) > 3^{\circ}C$ $(T_{in} - T_{out}) < 2^{\circ}C$	N	---

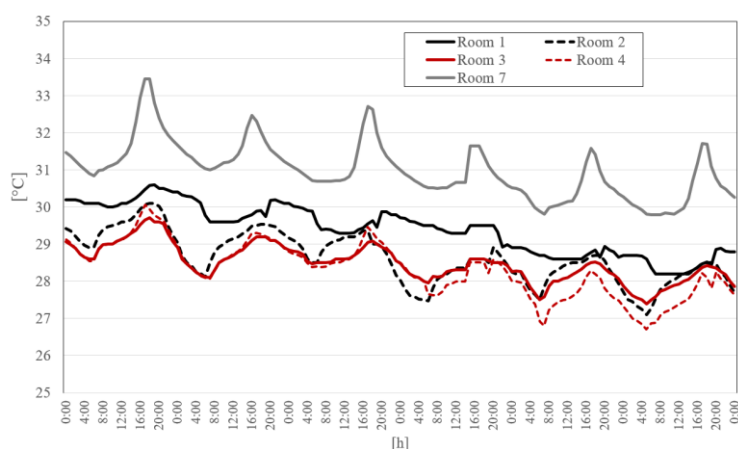

Fig.9 AIR TEMPERATURE PROFILE IN SELECTED LIVING LAB ROOMS DURING THE MONITORING IN AUGUST 2021

6. Discussion, Lessons Learned

6.1 Summary

This field study demonstrated the potential of advanced dynamic windows to mitigate the indoor built environment and the energy use for cooling. This solution can be effective in energy renovation projects, where the complete retrofit is difficult to be pursued. Advanced windows in this case can be used to avoid the heat entering into the building, as well as to remove heat (and eventually humidity) from the building. The advantages were proven in both conditions, with the active cooling and in thermal free cooling.

6.2 Lesson learned

- The solar selective glazing units allowed to strongly reduce the solar gains. The addition of venetian blinds inside the glazing gap had a limited additional impact, depending also on west – north/west orientation of the Living Lab rooms.
- The venetian blinds could be more effective in case of conventional glazing units with high solar factor. In case of high performing glazing, additional shading might be dedicated to daylighting, rather than to additional solar control.
- The night ventilation by windows opening has effective results, by reducing the temperature by 1-1.5°C with respect to the same room and window configuration but with the window opening inhibited.
- The night ventilation was however limited by the opening of the windows, maximum 30 degree of angle opening with respect to the closing position (angle 0°) of the motorized sash. Greater aperture angles may create favorable conditions of higher ventilation rates. The limitation of the technology is a barrier in this case.
- The high performance air conditioning units ensure low final energy use. The number of working hours is also strongly reduced in rooms with advanced windows in comparison with the old ones.
- The motorized and automated windows received good acceptance by the majority of the room occupants, one worker complained for not being allowed to manage the windows settings according to his preference during the monitoring. This aspect about remote control needs further investigation in the perspective of the user-centric management of buildings.

7. References & Key Contacts

7.1 References

ASHRAE, ANSI/ASHRAE Standard 169-2013, Climatic Data for Building Design. Atlanta: ASHRAE, 2013.

Martina Botticelli, Stefano Agnoli, Sabrina Romano, Michele Zinzi, **Exploiting passive cooling in office buildings with advanced automated glazing systems: preliminary analyses from a field study**, *5th International Conference On Building Energy And Environment (COBEE)*, Montreal, 25-29 July 2022.

Michele Zinzi, Martina Botticelli, Francesca Fasano, Paolo Grasso, Giacomo Chiesa. **Comparing the thermal performance of Living Lab monitoring and simulation with different level of input detail**, presented at *IAQVEC 2023 - 11th international conference on indoor air quality, ventilation & energy conservation in buildings*, Tokyo, May 20-23, 2023.

7.2 Interesting links and Downloads

EDYCE - Energy flexible DYnamic building CErtification (<https://edyce.eu/>). EU Horizon 2020 Project. The Task 4.3 outcome is an extensive report dealing with the activities carried out in the Living Lab and the related simulation analyses.

7.3 Contacts

Company	Role	Contact
ENEA – Italy	Researcher	Michele Zinzi (michele.zinzi@enea.it)
Politecnico di Torino - Italy	Researcher	Giacomo Chiesa (giacomo.chiesa@polito.it)

1. Introduction & Climate

1.1 Introduction

This is a historic building, built at 1784-1790, which has been refurbished to an office building for the municipality staff. The building has a total usable area of around 2100 m² consisting of three floors, accommodating the office rooms, a basement, accommodating the central engine room connected to the district heating network, and an attic, accommodating the ventilation rooms for the two air handling units and a vapor compression chiller. The central chiller cools supply air (ventilative cooling) to remove excessive heat. This historic building offers an interesting perspective in view that external and building envelope intrusions, by passive means, are prohibited.



Fig.1 EXTERIOR VIEW, SOUTHEAST VIEW, HISTORIC OFFICE BUILDING

Table.1 KEY INFORMATION ABOUT THE BUILDING

Location	Gävle, Sweden
Building Type	Historic building refurbished to an office building
Retrofit (Y/N)	Y (installation of HVAC systems in 90s)
Surroundings (Urban/Rural)	Urban
Year of Completion	1790
Floor Area (m²)	2100
Climate Zone	Cold & temperate (6A) Köppen & Geiger: Dfb
No. of Days with Te max > 25	18
Cooling Season Humidity	17%-99% (Average=71.4%)
Heating Degree days (Kd)	3446

1.2 Local Climate

Location: The building is located in the central part of Gävle In Rådhusorget 1. Coordinates: 60.6749° N, 17.1413° E.

Climate Zone: The building is in Dfb climatic zone according to Köppen-Geiger climate classification system (Dfb: warm summer humid continental) and 6A according to ASHRAE.

Climate Zone	Description
0A	Extremely Hot Humid
0B	Extremely Hot Dry
1A	Very Hot Humid
1B	Very Hot Dry
2A	Hot Humid
2B	Hot Dry
3A	Warm Humid
3B	Warm Dry
3C	Warm Marine
4A	Mixed Humid
4B	Mixed Dry
4C	Mixed Marine
5A	Cool Humid
5B	Cool Dry
5C	Cool Marine
6A	Cold Humid
6B	Cold Dry
7	Very Cold
8	Subarctic

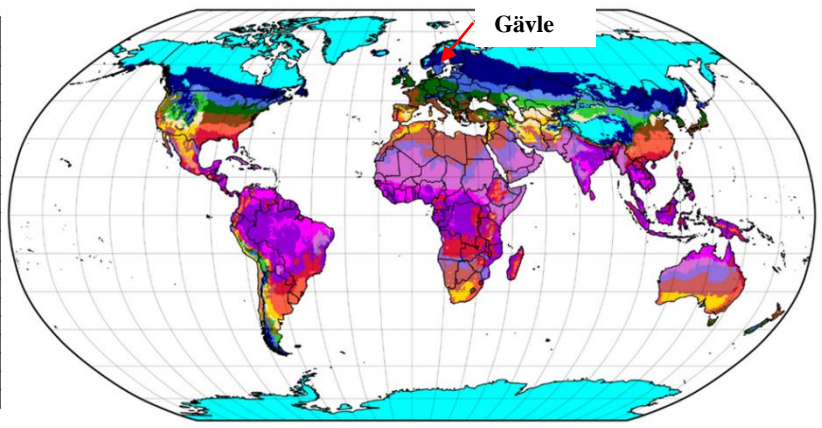

Fig.2 CLIMATE MAP (ASHRAE 169 - CLIMATE DATA FOR BUILDING DESIGN STANDARDS)

Building Information

2. Building

2.1 Envelope and Construction

The building was internally refurbished to an office building in 1996. Though completed in 1790, it was seriously damaged after Gävle city fire in 1869. Reparations in 1872 has given the building’s external expression it has today which is protected as a listed building. The building has not undergone any changes in construction except additional insulation on the attic floor and installation of HVAC systems within the attic, thus additional insulation therein whilst increasing heated floor area.

Special features of the building envelope and construction

- Envelope’s construction is mainly bricks
- 3 office floors, 1 basement, 1 attic
- Internal floors/ceilings are mainly wood and sand and internal walls are mainly brick
- Tall 2-pane glazing with clear glass and wooden frame

Table.2 INFORMATION PLANNING, OPERATION AND USE

Information on planning, operation and use

Object use	Office use
Technical management	One department of the owner company, Gavlefastigheter Co., is responsible for the management of the building, The sister company, GDS Co., is responsible for technical management
Energy monitoring	A Building Management System monitors the main parameters of the HVAC system including the energy use.

Table.3 BUILDING PROPERTIES

Property	Unit	Value
Hours of occupancy	h/week	40
Window U-value	W/m ² K	2,8 (glazing)
Window g-value	-	0,75
Wall U-value	W/m ² K	0,38 - 0,82
Roof U-value	W/m ² K	2,9
Floor U-value	W/m ² K	0,51
Q-value (from Japan)	(W/m ²)K	--
Window to Wall Ratio	%	12,8
Air-tightness (@50 Pa)	l/h	2,3

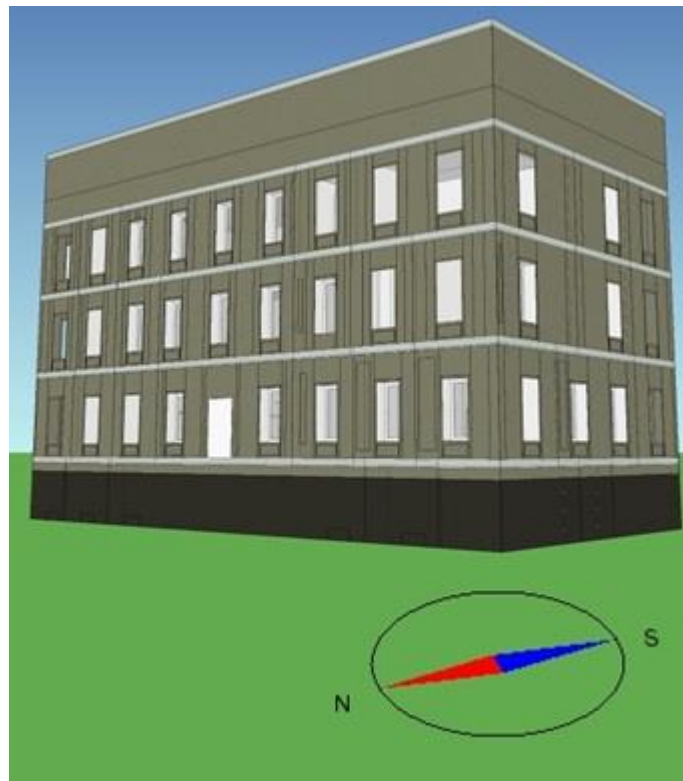

Fig.3 3-D SIMULATION MODEL OF THE BUILDING IN IDA-INDOOR CLIMATE AND ENERGY (IDA-ICE) SIMULATION SOFTWARE. NORTHWEST & SOUTHWEST FACADES

2.2 Energy Systems

Schematic design of energy system

Different systems are used for the energy supply. Electricity is supplied by the public grid. There are two main categories of electricity use including operation electricity use (for lighting and in electrical appliances) and electricity use for property and building services. The building is heated by district heating; both space heating and domestic hot water (DHW). Space cooling is achieved by a ventilative cooling system, a vapor compression chiller in combination with the air-handling units (AHUs). The chiller absorbs the heat from the supply air and ejects it to the exhaust air. There are two AHUs installed in the attic, each ventilating half the office rooms in the building (called FTX1 and FTX2). The entire building is ventilated, except for the attic, some staircases, some corridors, and some zones in the basement. Rest rooms (WCs) have only exhaust ventilation.

Figure 4 illustrates the district heating supply scheme for domestic hot water (DHW) and space heating via radiators and supply air pre-heating. This is done with a two-step heat exchanger. Heat exchanger HX2 delivers heat to the radiator system and AHU (variable supply temperature, based on control and time schemes, and especially the outdoor temperature) and the returning DH water is then entered into HX1 to pre-heat incoming cold DHW. The heating of DHW is enhanced by the second step in HX1 as well as re-heating circulating DHW.

Each thermal zone has hydronic radiators which are equipped with thermostatic radiator valves, which are manually adjusted for the desired indoor temperature.

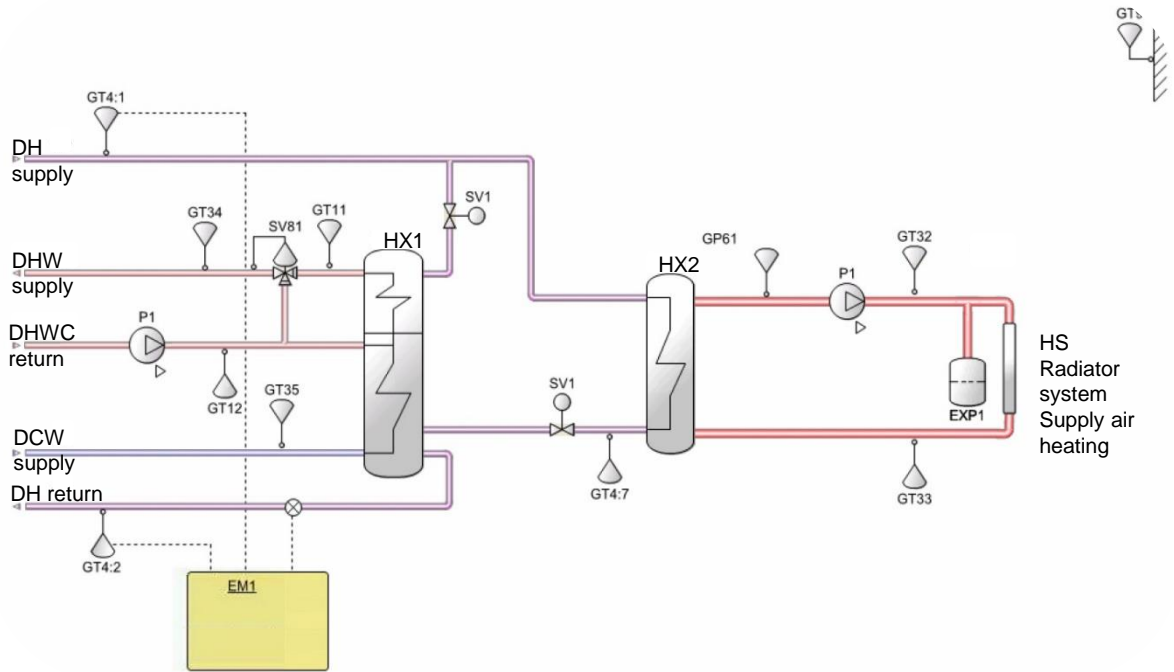

Fig.4 THE SCHEMATIC OF THE HYDRONIC SYSTEM (HS), DOMESTIC HOT WATER (DHW) SYSTEM AND DISTRICT HEATING CONNECTIONS (DH). **GT:** TEMPERATURE (TEMP.) SENSOR; **GP:** PRESSURE SENSOR; **SV:** VALVE; **P:** CIRCULATION PUMP; **VVX:** HEAT EXCHANGER; **DH:** SUPPLY AND RETURN DISTRICT HEATING; **DHW:** SUPPLY AND RETURN DHWC CIRCULATION; **DCW:** COLD WATER; **EM1:** SUPPLIED DH ENERGY METER **GT9:** OUTDOOR TEMP.; **GT32:** HS SUPPLY TEMP.; **GT33:** HS RETURN TEMP.; **GT34:** DHW SUPPLY TEMP.; **GT12:** DHW RETURN TEMP.; **GT4:1:** DH SUPPLY TEMP.; **GT4:2:** DH RETURN TEMP.; **LEFT HX1:** HEAT EXCHANGER FOR DHW; **RIGHT HX2:** HEAT EXCHANGER FOR HYDRONIC RADIATOR SYSTEM

The fans of the ventilation systems are frequency controlled as to obtain stable flows in each zone of the building by leveling pressure difference between outdoor and indoor environment and between zones. The two AHU systems are equipped with rotary energy recovery exchangers. Each AHU has a DH heating coil to boost supply air temperatures when outdoor temperatures are low (maximum 25 °C). In each AHU cooling coil conditions, the temperature of supply air with cold from the chiller. Each zone has a wall mounted thermostat that increases the chilled supply air flow (changes position of the local damper) if colder room temperature is desired. However, there are doubts on whether or not occupants have understood this function, since the city hall has periodically hosted several different municipality employees when the buildings of their offices have undergone major renovations.

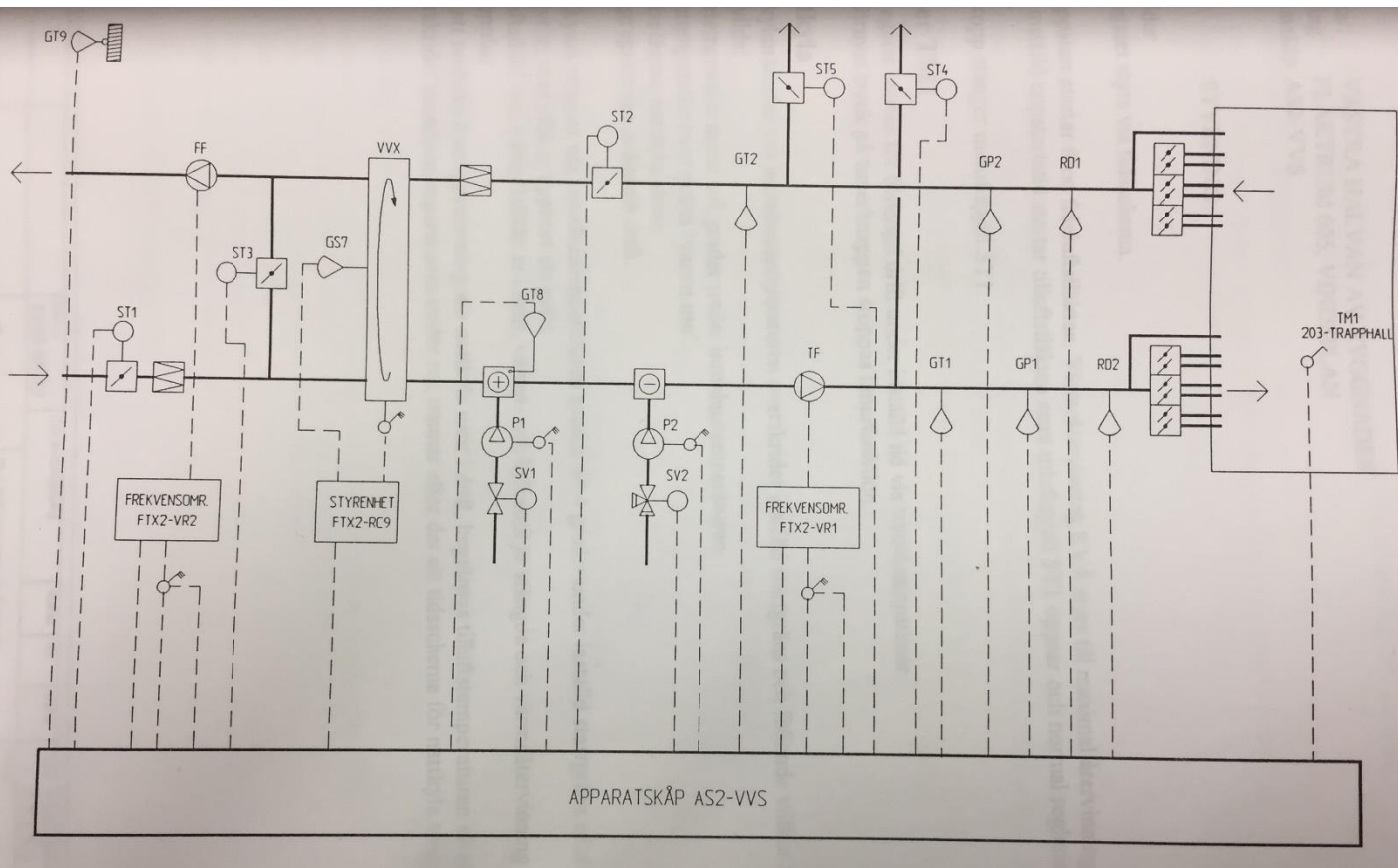

Fig.5 THE SCHEMATIC OF AIR-HANDLING UNIT (AHU).

GT: TEMPERATURE (TEMP.) SENSOR; **GP:** PRESSURE SENSOR; **P:** CIRCULATION PUMP; **TF:** SUPPLY FAN; **FF:** EXHAUST FAN; **SV:** VALVE; **ST:** VENTILATION DAMPER; **VVX:** ROTARY HEAT EXCHANGER

GT9: OUTDOOR TEMP; **GT1:** SUPPLY AIR TEMP.; **GT2:** EXTRACT AIR TEMP.; **GP1:** SUPPLY AIR PRESSURE; **GP2:** EXTRACT AIR PRESSURE; **P1:** CIRCULATION PUMP IN THE HEATING COIL CIRCUIT; **P2:** CIRCULATION PUMP IN THE COOLING COIL CIRCUIT; **ST1:** VENTILATION MAIN INLET DAMPER; **ST3:** BYPASS VENTILATION DAMPER

An (aged) chiller system generates cold that is distributed to the cooling coils of AHUs, as displayed in Figure 6. There are two in-built vaporization compressors in the chiller which stepwise work depending on the cooling demand, sensing the extracted mean air temperatures of the two AHUs (FTX1 and FTX2), i.e. the average air temperatures from the zones. In turn, the rejected heat is removed by exhaust air after passing the rotary energy exchangers.

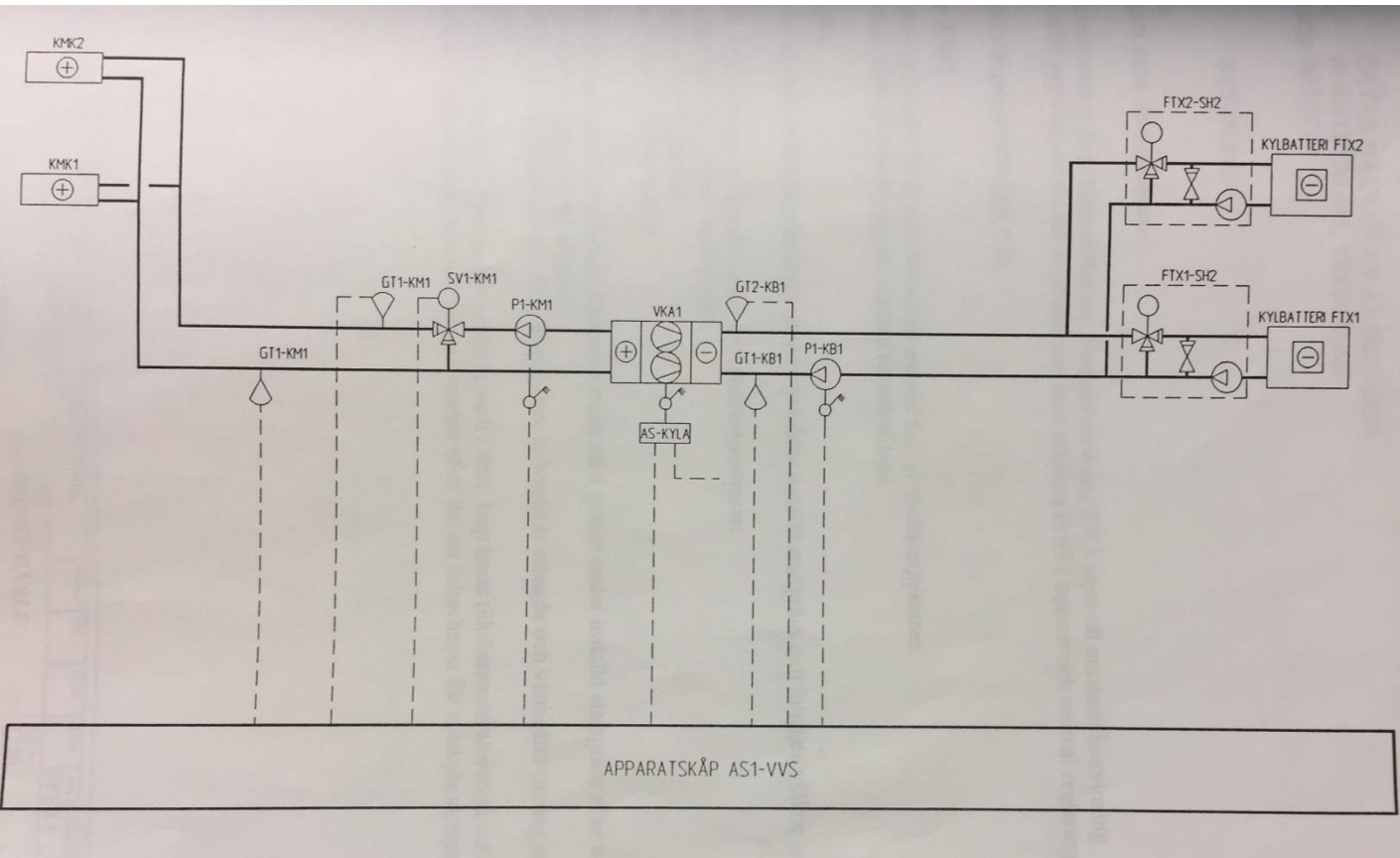

Fig.6 THE SCHEMATIC OF THE VAPOR COMPRESSION CHILLER CONNECTED TO THE TWO AIR-HANDLING UNITS (AHUs), NAMELY FTX1 AND FTX2. **GT:** TEMPERATURE SENSOR; **SV:** VALVE

3. Resilient Cooling

3.1 Principles

In principle, the rooms are cooled by introducing conditioned supply air into the room. There are two air-handling units (AHUs), each supplying half of the office rooms in the building. There is vapor compression chiller coupled to both AHUs which is responsible for cooling down the air in the supply air. The chiller extracts heat from the supply air and ejects it to the exhaust air after the energy recovery exchanger in the AHUs. Ventilation of the building is used for controlled ventilation of office rooms. Supply and exhaust air characteristics (maximum ventilation rates for the variable air volume system) are presented below in form of supply/exhaust flow rates:

- AHU No. 1 (FTX1): 4,630/4,504 m³/h
- AHU No. 2 (FTX2): 5,436/5,555 m³/h

3.2 Structure of resilient cooling technology

REMOVING HEAT FROM INDOOR ENVIRONMENT

Ventilation System

- Fans: The supply fan is responsible for introducing the cooled air into the room. It conducts the fresh ambient air through the heat exchanger and cooling coil and supply it to the room as the supply air. The exhaust fan is responsible for extracting the extract air from the room. The extract air is then returned to outdoors via the extract air duct as exhaust air.
- Cooling coil: The cooling coil is responsible for lowering the temperature of the supply air. It is in fact the evaporator of the chiller.
- Energy recovery: The ventilation system has a rotary air-to-air enthalpy wheel that increases the efficiency of the system. The heat recovery uses the heat or cold of the exhaust air to heat the fresh air in winter and to cool it in summer.

Table.4 STRUCTURE OF THE SYSTEM

1. Reducing heat loads to people and indoor environments	
1.1.	Advanced solar shading
1.2.	Advanced cool materials
1.3.	Advanced glazing technologies
1.4.	Ventilated façades
1.5.	green roofs, green façades
2. Removing heat from indoor environments (production, emission and combined)	
2.1.	Ventilative cooling
2.2.	Thermal mass utilization
2.3.	Evaporative cooling
2.4.	Sky radiative cooling
2.5.	Compression refrigeration machines
2.6.	Adsorption chillers
2.7.	Natural heat sinks
2.8.	Radiant Cooling
3. Increasing personal comfort apart from space cooling	
3.1.	Comfort ventilation and elevated air movement
3.2.	Micro-cooling and personal comfort control
4. Removing latent heat from indoor environments	
4.1.	Dehumidification

According to the function description of AHUs in the building, the control strategy for night ventilation in the building is described as follows:

Night ventilation (NV) starts functioning if the following conditions are simultaneously fulfilled:

- (1) The night ventilation duration (schedule) is active (i.e. the time is within the defined period for NV duration). In this case, 01:00-05:00 during weekdays has been defined as the NV duration (schedule).
- (2) The ambient temperature is at least 2 degrees cooler than the extract ventilation air temperature.
- (3) The ambient temperature is greater than the minimum acceptable level of 11 degrees (to avoid condensation problem on internal surfaces).
- (4) The extract ventilation air temperature is greater than the temperature limit of 23 degrees.

Night ventilation stops functioning if the extract ventilation air temperature drops below 19 degree (i.e. 4 degrees below the temperature limit of 23 degrees) or if any other criterion mentioned above is violated.

3.3 Design simulation

The effect of mechanical night ventilation (MNV) control strategy on thermal comfort in office rooms and on the electricity use and electrical peak power demand for cooling under both current and future climatic conditions in 2050s for the Gävle City in Sweden (the location of the building) was simulated using BES modelling by IDA Indoor Climate and Energy (IDA-ICE) simulation program.

To simulate/model the MNV strategy, the ventilation unit’s extract air and ambient temperature limit were set to 18 and 10 ° C, respectively, and the benefit limit (i.e., the difference between ambient and extract air temperatures) was defined as +2 ° C. It means that the MNV starts if all the following conditions are fulfilled and stops if any of them is missed:

- (1) The time is during the period defined for MNV schedule;
- (2) The ventilation unit’s extract air temperature is over 18 ° C;
- (3) The ambient temperature is over 10 ° C;
- (4) The ambient temperature is at least 2 ° C lower than the extract air temperature.

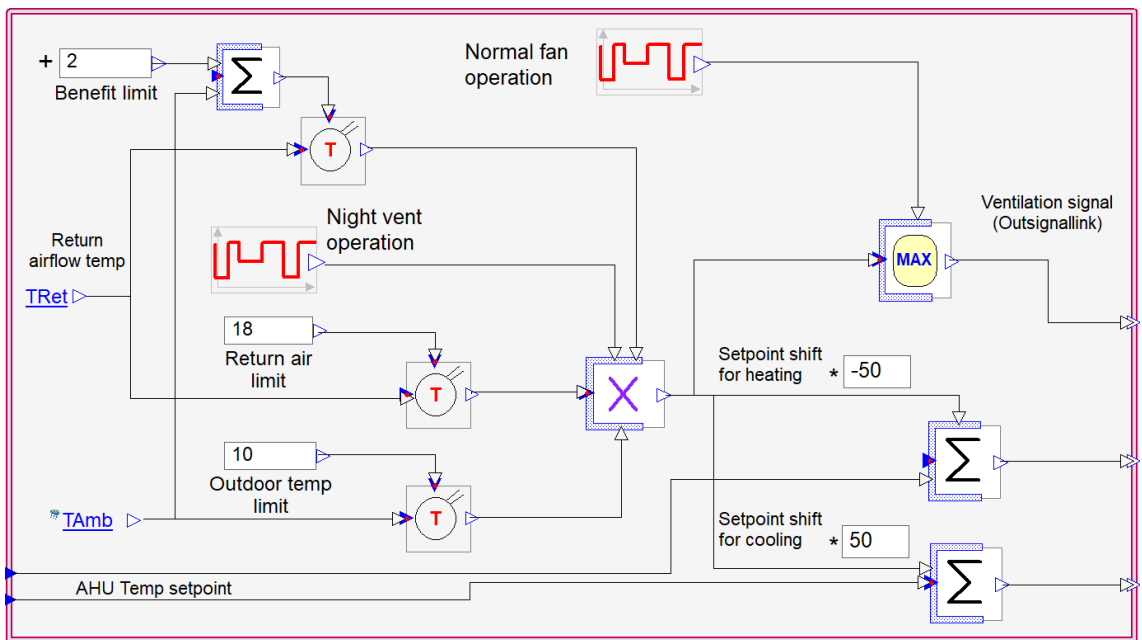

Fig.7 THE SCHEMATIC OF MECHANICAL NIGHT VENTILATION (MNV) SIMULATION MODEL

Under the typical (related to the period 1981-2010) and the extreme (related to the year 2018) current summer climatic conditions, it was shown that MNV cannot meet the total cooling demand of the representative studied floor of the building and auxiliary active cooling is required, although the building is located in a cold climate. MNV had the potential in decreasing the percentage of exceedance hours in offices by up to 33% and decreasing the total electricity use for cooling by up to 40%. More electricity is saved with higher mechanical night ventilation rates. There is, however, a maximum beneficial ventilation rate above which the increase in electricity use in fans outweighs the decrease in electricity use in the vapor compression chiller. It depends on thermal mass capacity of the building, chiller’s coefficient of performance, design ventilation rate, and available night ventilation cooling potential (ambient air temperature).

For the whole building, under the typical current (related to the period 1981-2010) and future (projected midterm for 2041-2060, called 2050s) summer climatic conditions, the results show that, for coefficient of performance of 3 and specific fan power of 1.5 kW/(m³/s), it would be possible to lower the electrical peak power demand and the electricity use in cooling machine by up to 2.2 kW (13%) and 1.4 MWh (48%) by mechanical night ventilation rate of 2.1 lit/(s·m²) at typical future climate in 2050s. Corresponding figures for typical current climate are 4.6 kW (36%) and 0.9 MWh (72%) owing to cooler nights and more diurnal temperature differences.

4 KPI Evaluation

4.1 Thermal comfort KPIs

Hours of exceedance (HE): Hours outside the range of 26 ° C for operative temperature (corresponding to 24.5 ° C for air temperature)

Offices in southern half of the building: 252 h/a

Offices in northern half of the building: 119 h/a

Indoor Overheating Degree (IOD): Hourly summation of the positive values of the difference between the operative temperature of the occupied building thermal zones and the zonal thermal comfort limit temperature (26 C), divided by the sum of the zonal occupied hours. **IOD= 0.2 (° C)**

Ambient Warmness Degree (AWD): Hourly summation over the summertime period of the positive values of the difference between the outdoor air temperature and a fixed base temperature (18 C), divided by the total number of building occupied hours. **AWD_{18°C}=1.8 °C**

Overheating Escalation Factor (OEF): An indicator of the resistivity of a building to climate change and associated overheating risk. **$\alpha_{IOD}=0.11$**

Note: The results above are based on on-site measurement results during 1 Jun. - 30 Sep. 2021 & 1-31 May. 2022. The on-site measurements were carried out for air temperatures in office rooms. Simulation results using the building energy simulation (BES) model of the building indicated that the maximum limit of 24.5 ° C for air temperature corresponds to the maximum limit of 26 ° C for operative temperature

4.2 Energy KPIs

Annual energy demand intensity: Annual cooling load per conditioned floor area. Based on on-site measurement results during 1 Jun. - 30 Sep. 2021 & 1-31 May. 2022 **4.3 kWh/(m².a)**

Annual cooling source energy saving intensity: The annual reduction of source energy for cooling, per conditioned floor area, achieved by applying mechanical night ventilation (MNV) strategy with night ventilation rate (NVR)= 1.7 ACH. Based on simulation results.

At typical current climate (1991-2020): 0.6 kWh/(m².a)

At typical future climate (2050s): 1.0 kWh/(m².a)

4.3 HVAC and grid KPIs

Reduction in peak source power demand intensity: The annual reduction of source peak power demand, per conditioned floor area, achieved by applying mechanical night ventilation (MNV) strategy with night ventilation rate (NVR)= 1.7 ACH. Based on simulation results.

At typical current climate (1991-2020): 3.1 W/m²

At typical future climate (2050s): 1.5 W/m²

4.4. Carbon dioxide (CO₂) emissions

The annual amount of (CO₂) emissions : Annual electricity use for space cooling is 6404 kWh/a (i.e. 4.3 kWh/(m².a) for 1490 m² conditioned floor area), and the carbon dioxide (CO₂) emissions factor is 0.49 g CO₂e/kWh (CO₂e indicates CO₂ equivalent). Based on on-site measurement results during 1 Jun. - 30 Sep. 2021 & 1-31 May. 2022

2.11 gCO₂e/ m². a

Note that The building's owner, Gavlefastigheter Company, signed a contract with the electricity supplier company in 2017 according to which the purchased electricity for the building is only from nearly CO₂-emission-free resources like wind power, hydropower, and the like. Accordingly, the Carbon dioxide (CO₂) emissions factor for the purchased electricity has always been the low value of 0.49 g CO₂e/kWh since 2017.

5. Performance Evaluation

5.1 Energy

Monthly balance of energy producers

Figure 8 shows the monthly balance of the energy use from 1st of June 2021 to 31st of May 2022. The electricity supply for building services and operation electricity use is provided by electricity purchased from the grid. The electricity supply for operation electricity use and building services amounts to 25.7% in relation to the total energy use of the building. The heat use of the City Hall in Gävle is covered by district heating (74.3% of the total energy use) and cooling is supplied by ventilative cooling system (including a vapor compression chiller connected to two air-handling units).

Monthly balance energy use

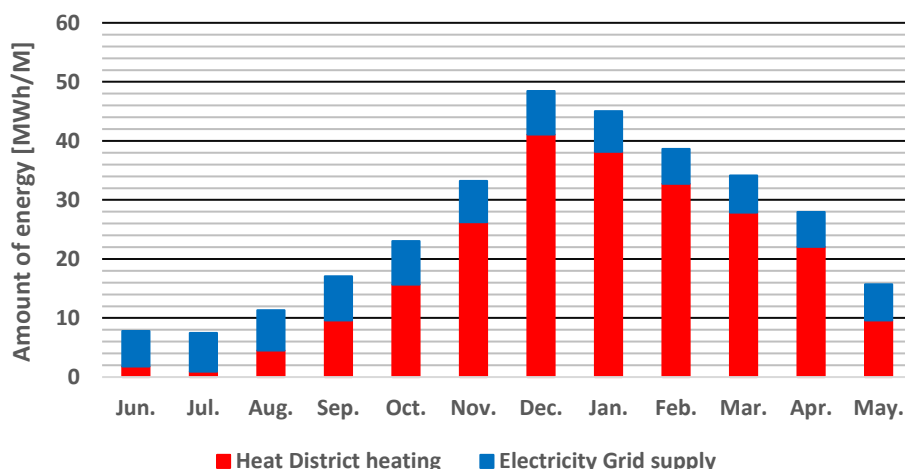

Fig.8 ENERGY BALANCE ENERGY USE, JUN. 2021 – MAY. 2022, THE CITY HALL IN GÄVLE

Energy demand structure heat

The total heat use in the measurement period June 2021 - May 2022 is around 230,200 kWh.

The measured specific primary energy performance in the building is around 130 kWh/m².a. This is around two times higher than the maximum acceptable value for new office building (i.e. 70 kWh/m².a) according to the Swedish National Board of Housing, Building, and Planning (Boverket). Figure 9 below shows the monthly heat demand structure. According to Figure 9, the electricity use for space cooling in the chiller's compressors and AHUs' fans account for 2.7% of the total energy use in the building during the whole year (i.e. the measure period of Jun. 2021 - May. 2022).

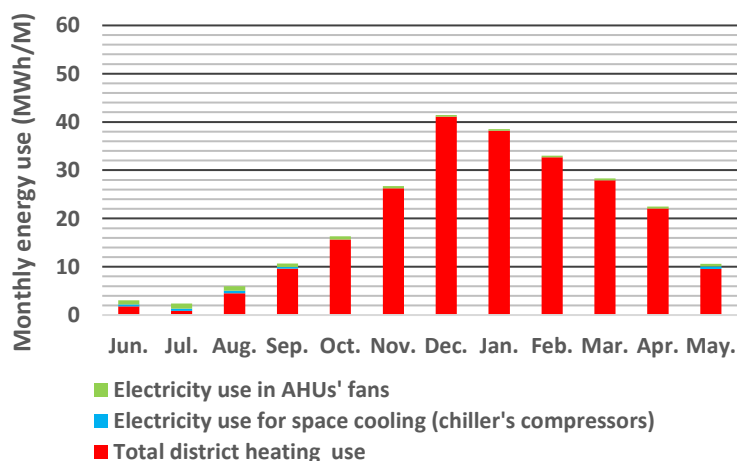

Fig.9 MONTHLY ENERGY USE, JUN. 2021 – MAY. 2022 - THE CITY HALL IN GÄVLE

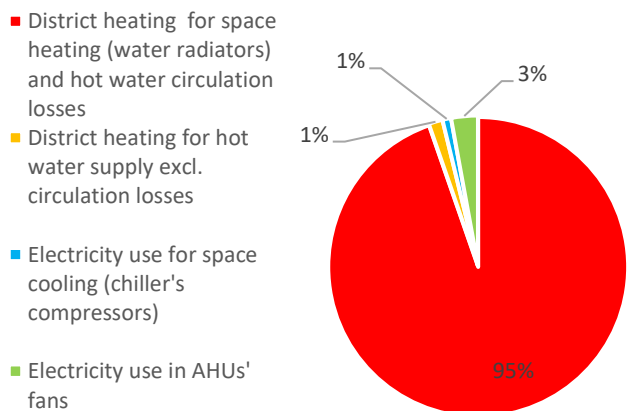

Fig.10 ENERGY USE BREAKDOWN, THE CITY HALL IN GÄVLE

5. Performance Evaluation

Energy demand structure cooling

The space cooling in the building is met by ventilative cooling. The total electricity use for space cooling consists of two main parts: (1) electricity use in chiller’s compressor and (2) electricity use in AHUs’ fans. The electricity use in chiller’s compressor and in AHUs’ fans in the measurement period June 2021 to May 2022 is around 2,300 kWh (36% of the total electricity use for space cooling) and 4,100 kWh (64% of the total electricity use for space cooling), respectively. Figure 11 shows the monthly cooling demand structure.

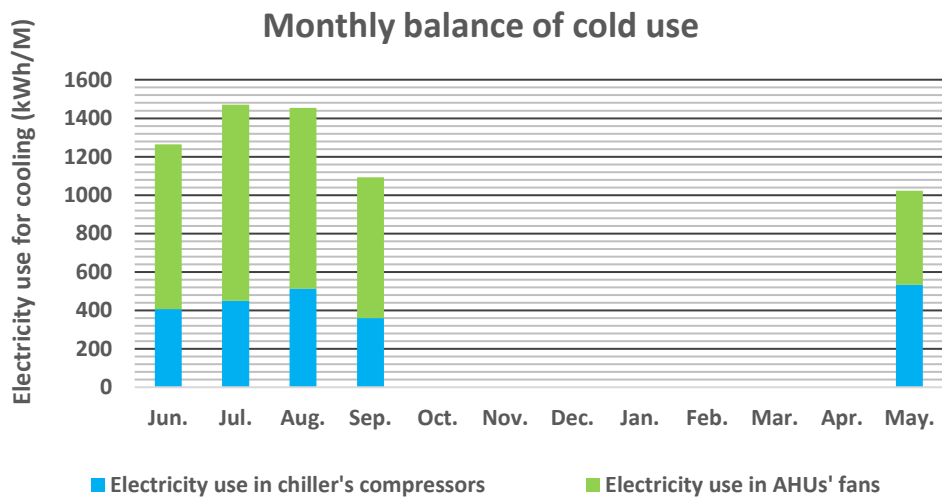
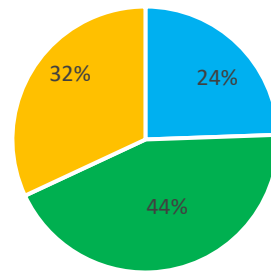

Fig.11 MONTHLY COLD USE, JUN. 2021 – MAY. 2022, THE CITY HALL IN GÄVLE

Power consumption and benchmarks

The total electricity use of the zones and building services in the measurement period (1 June 2021 – 31 May 2022) is around 79,700 kWh, or 37.9 kWh/m². The maximum hourly electrical power use is approximately 27.5 kW, or 13.1 W/m². The electricity base load in the building is approx. 6.5 kW and causes an annual base load use of around 56,950 kWh (71% of the total electricity use). The electricity base load is the measured electricity use in the building during weekends, when there is no electricity use for lighting and equipment in offices and no electricity use for building services since ventilation units are off during weekends. The electricity use in circulation pumps of the heating system and in the electrical appliances in the kitchens account for the main part of the electricity base load.



- Electricity use for space cooling (chiller's compressors) (Jun. 2021 - Sep. 2021 & May 2022)
- Electricity use in AHUs' fans - Cooling season (Jun. 2021 - Sep. 2021 & May 2022)
- Electricity use in AHUs' fans - heating season (Oct. 2021 - Apr. 2022)

Fig.12 ELECTRICITY USE IN CHILLER’S COMPRESSORS AND AIR HANDLING UNITS’ FANS, THE CITY HALL IN GÄVLE

5. Performance Evaluation

5.2 Comfort

The building's orientation from north is 45°. The building is categorized/clustered into two halves:

- “Southern half” including offices with only southeastern windows, or southeastern & southwestern windows, or southeastern & northeastern windows, or only northeastern windows; total area = 417 m².
- “Northern half” including offices with only northwestern windows, or northwestern & northeastern windows, or northwestern & southwestern windows; total area = 529 m².

The area-weighted average air temperature was calculated for each category/cluster. Discomfort degree hours (DDH) during working hours (08:00-17:00 during weekdays) was defined as follows with the unit of degree hours):

$$\text{DDH for cooling season: } DDH_+ = \sum_{t=1}^N h_t (AT_t - 24.5) \quad \begin{cases} h_t = 1 \text{ h if } AT_t \geq 24.5 \text{ }^\circ\text{C} \\ h_t = 0 \text{ if } AT_t < 24.5 \text{ }^\circ\text{C} \end{cases}$$

The ventilative cooling system is supposed to completely fulfill thermal comfort, which means that the discomfort degree hours (DDH) must be zero, in all office rooms during the whole cooling season. According to Table 5, it is shown that the ventilative cooling system does not manage to completely fulfill thermal comfort in all office rooms during the whole cooling season. DDH has acceptably low values only in 2% of all office rooms (i.e. only 2 office rooms amongst the northern half offices) during the cooling season.

Table.5 AVERAGE AIR TEMPERATURES AND DISCOMFORT DEGREE HOURS IN OFFICE ROOMS DURING COOLING SEASON

Measurement period: 01 Jun. 2021 - 31 May. 2022			
Reference room	Southern half offices	Northern half offices	
Average room air temperature in the cooling period (1 Jun. - 30 Sep. 2021 & 1-31 May. 2022)	23.6	22.8	°C
DDH in the cooling period (air temperatures > 24.5 ° C) (1 Jun. - 30 Sep. 2021 & 1-31 May. 2022)	Average: 246 Range: 48 - 638	Average: 82 Range: 1 - 346	°C·h

6. Discussion, Lessons Learned

6.1 Summary

The main sources of energy supply in this historic office building are district heating (DH) and electricity networks. Space heating and domestic hot water (DHW) preparation systems are connected to DH network. Space heating is carried out by hydronic system (radiators) and DHW is prepared in a storage tank by an indirect heat exchanger. Space cooling is done by ventilative cooling system supplied by a vapor compression chiller, ejecting the absorbed heat from the supply air into the exhaust air. There are two air-handling units (AHUs) connected to the office rooms. The daytime ventilation is of variable air volume (VAV) type based on air temperature control in office rooms and night ventilation (NV) is of constant air volume (CAV) type. The electricity use for space cooling in the chiller's compressors and AHUs' fans account for 68% of the total electricity use for both heating and cooling in the building (according to Figure 12 on page 12). The ventilative cooling in the building does not manage to completely fulfill thermal comfort in office rooms during the cooling season. A new ventilative cooling system with a larger capacity is required (with a new chiller – or district cooling exchanger- with a larger capacity and/or new AHUs with higher ventilation rates), leading to a higher share for electricity use for space cooling (i.e. higher than the mentioned 68%) in the total electricity use for both heating and cooling in the building

6.2 Optimization potential

Air-handling units (AHUs)

- The fans in AHUs are old. The specific fan power (SFP) of these fans in numerical studies on this historic office buildings was considered $1.5 \text{ kW}/(\text{m}^3/\text{s})$, based on the suggested values by the Swedish building regulations. One optimization potential is to replace the old fans with more efficient ones with lower SFP values which leads to lower electricity use in AHUs' fans. It is also worth mentioning that the mechanical night ventilation (MNV) strategy could not contribute to reducing the total electricity use for space cooling in both the vapor compression chiller and the AHUs' fans in the ventilative cooling system with the current high SFP values in AHUs' electrical fans. Electrical fans with SFP values lower than $1.0 \text{ kW}/(\text{m}^3/\text{s})$ are recommended for significant contribution of MNV strategy to reducing the total electricity use for space cooling.

Space cooling

- The current ventilative cooling in the building is not effective to fully meet the thermal comfort requirements in office rooms during the cooling season. A new ventilative cooling system with larger capacity is required (with a new chiller - or district cooling exchanger - with larger capacity and/or new AHUs with higher ventilation rates). AHUs with higher ventilation rates require larger canal systems in the building imposing a large renovation which is out of the questions in this historic building according to the Swedish building regulations for historic buildings. One optimization potential is to replace the ventilative cooling system with local cooling units and apply the ventilation only for the purpose of ventilating the office room and, if desired, for MNV.

Space heating

- The thermal mass of the building can be used as temporary thermal energy storage (TES) during heating season. In the final stage of research study on this historic office building, the plan is to investigate the effect of night preheating in the building on shaving the peak heating loads and the cost of purchased district heating energy during the heating season.

References & Key Contacts

7. References & Key Contacts

7.1 References

- [1] ASHRAE, ANSI/ASHRAE Standard 169-2013, Climatic Data for Building Design. Atlanta: ASHRAE, 2013.
- [2] H. Bakhtiari, Licentiate Thesis: "*Evaluation of Thermal Comfort and Night Ventilation in a Historic Office Building in Nordic Climate*", 2020.
- [3] H. Bakhtiari, J. Akander, M. Cehlin, and A. Hayati, "On the performance of night ventilation in a historic office building in nordic climate," *Energies*, vol. 13, no. 6, 2020, doi: 10.3390/en13164159.
- [4] H. Bakhtiari, S. Sayadi, J. Akander, A. Hayati, and M. Cehlin, "How Will Mechanical Night Ventilation Affect the Electricity Use and the Electrical Peak Power Demand in 30 Years? -A Case Study of a Historic Office Building in Sweden," *Int. Conf. Build. Energy Environ. (COBEE 2022)*, 2022.
- [5] P. Holzer, "Annex 80 - Resilient Cooling of Buildings Task Group Key Performance Indicators," p. 2020, 2020.
- [6] Z. Chen *et al.*, "IEA EBC Annex 80 - Dynamic simulation guideline for the performance testing of resilient cooling strategies - Version 2. DCE Technical Reports No. 306," no. December, p. 30, 2023.

7.2 Contacts

Company	Role	Contact
University of Gävle	Industrial PhD student	Hossein Bakhtiari hossein.bakhtiari@hig.se hossein.khosravi_bakhtiari@gavlefastigheter.se +46 70-084 09 56
Gavlefastigheter Gävle Kommun AB Company	Industrial PhD student & Energy Specialist	

ANNEX 80



www.iea-ebc.org