

# Cryogenic interferometric inertial sensors for penultimate mirror vibration monitoring

Morgane Zeoli<sup>1,2</sup>, L. Amez-Droz<sup>1,3</sup>, A. Amorosi<sup>1,3</sup>, R. Joppe<sup>4</sup>, T. Kuhlbusch<sup>4</sup>, C. Collette<sup>1,3</sup>, J.V. van Heijningen<sup>5,6</sup>

<sup>1</sup>Université de Liège, <sup>2</sup>Université Catholique de Louvain-la-Neuve, <sup>3</sup>Université Libre de Bruxelles, <sup>4</sup>RWTH Aachen University, <sup>5</sup>Vrije Universiteit Amsterdam, <sup>6</sup>Nikhef

## Introduction & context

- E-TEST is an international collaboration researching key technologies for the Einstein Telescope [1].
- E-TEST is a prototype suspension, combining passive and active isolation techniques, of a 100 kg silicon mirror cooled down radiatively to 25 K in a suspended cryostat [2,3].
- E-TEST seismic isolation calls for inertial sensors at each stage of the isolation chain.
- The sensors close to the mirror must be capable of operating in harsh cryogenic environments with extremely high sensitivity to monitor the residual vibration at the last isolation stage.

Horizontal and vertical cryogenic inertial sensors were developed to monitor the cryogenic penultimate stage down to sub-pm/VHz from 0.3 Hz onwards.

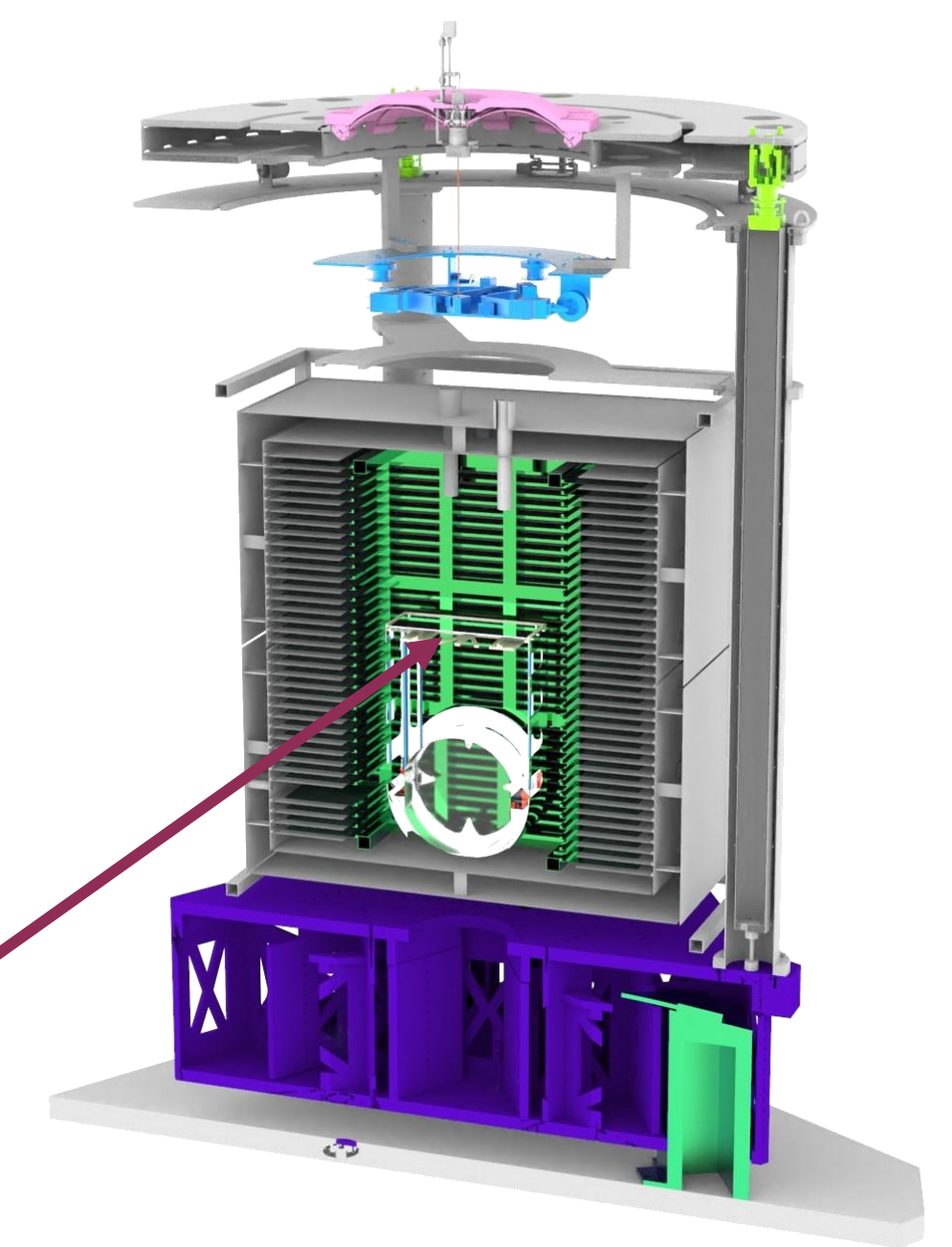

## Cryo-compatible optics

Validation of the cryogenic compatibility of the optical elements composing the interferometric readout

2.6  $\mu\text{m}$  extended InGaAs is necessary to compensate for the band-gap energy increase with temperature

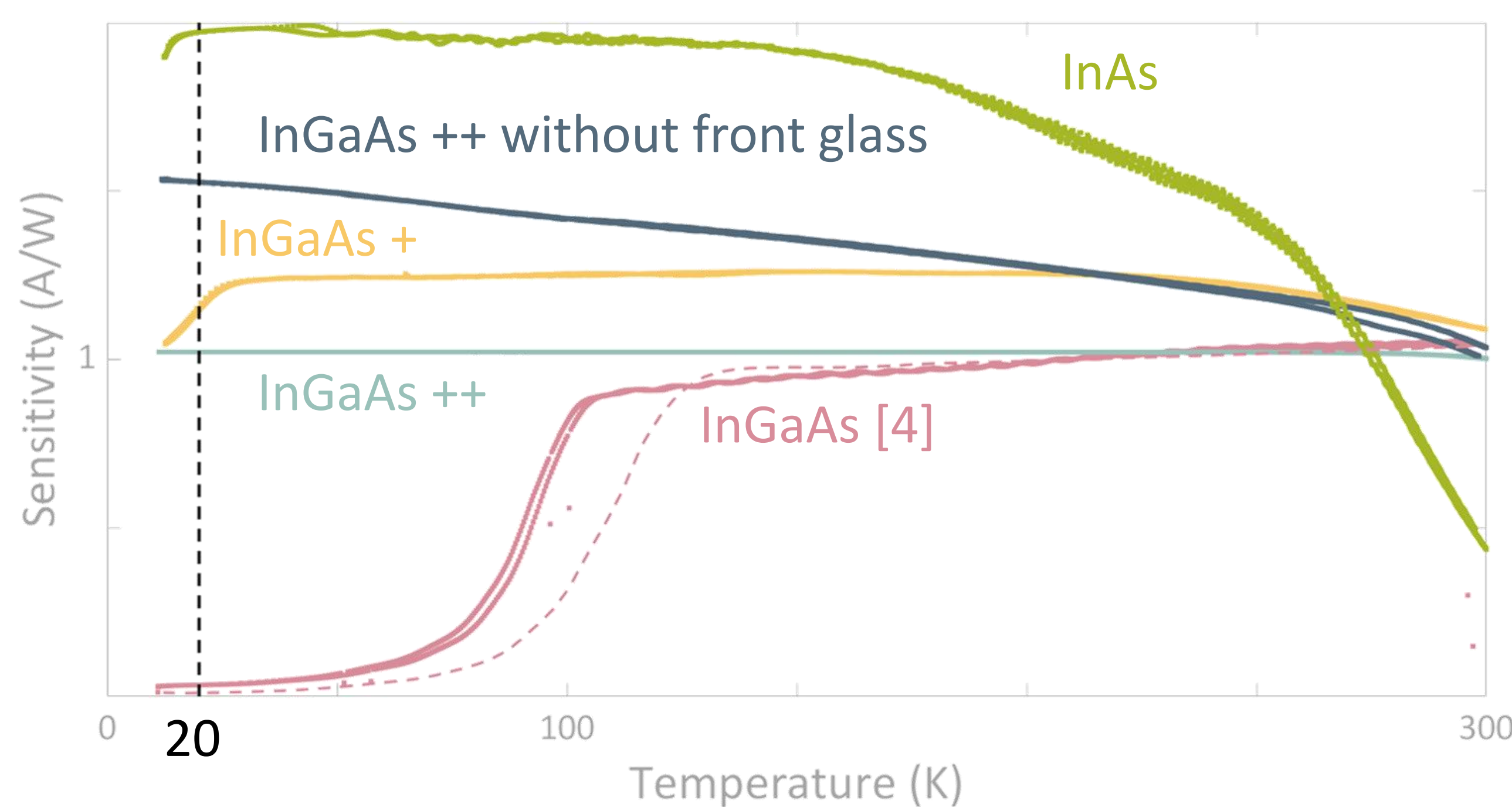
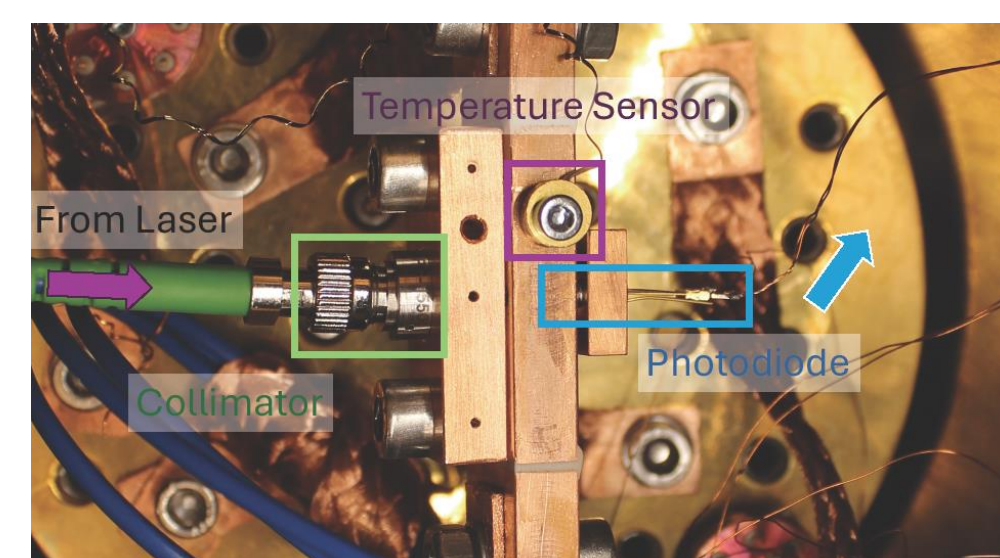

## Horizontal sensor

- $\text{Ti}_6\text{Al}_4\text{V}$  Watt's linkage with **closed-loop homodyne interferometric readout**
- Shielding magnets voice-coil actuator
- Differential signal as feedback to decrease the common noise to shot noise level

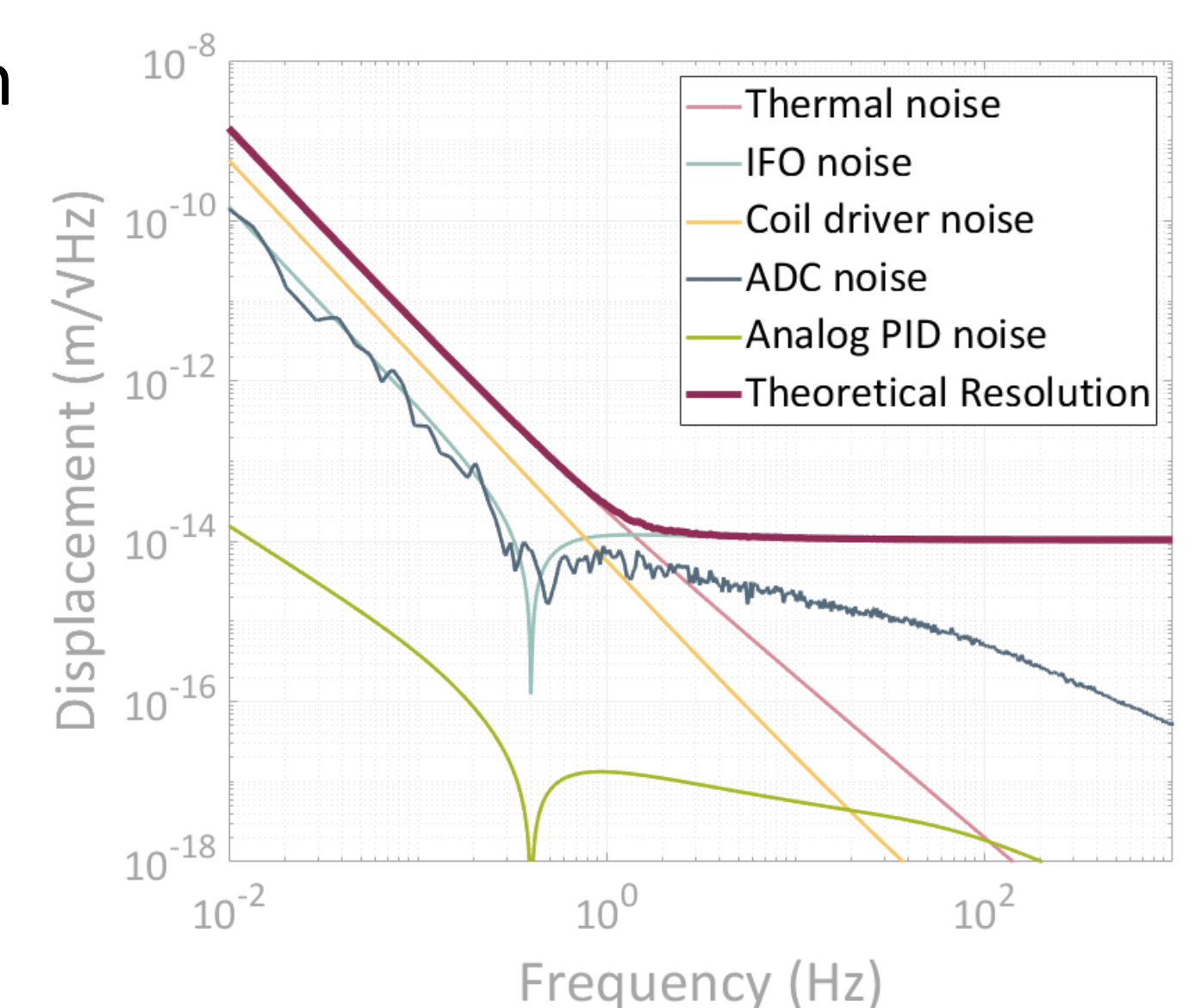

10 fm/VHz from 1Hz

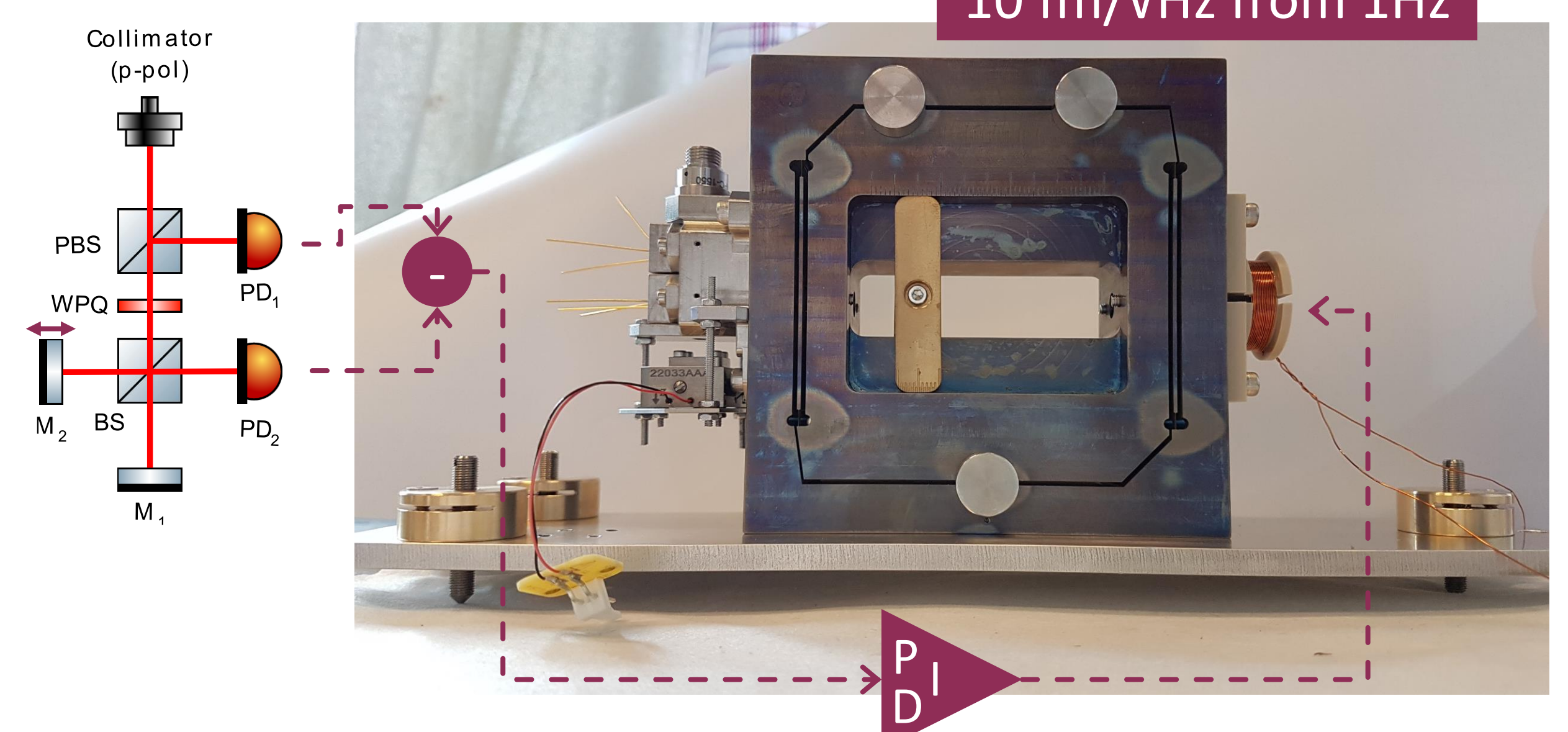

## Vertical sensor

- Stainless steel inertial mass maintained by a leaf-spring suspension
- **Homodyne quadrature interferometric readout** for parallel R&D and comparison with homodyne architecture

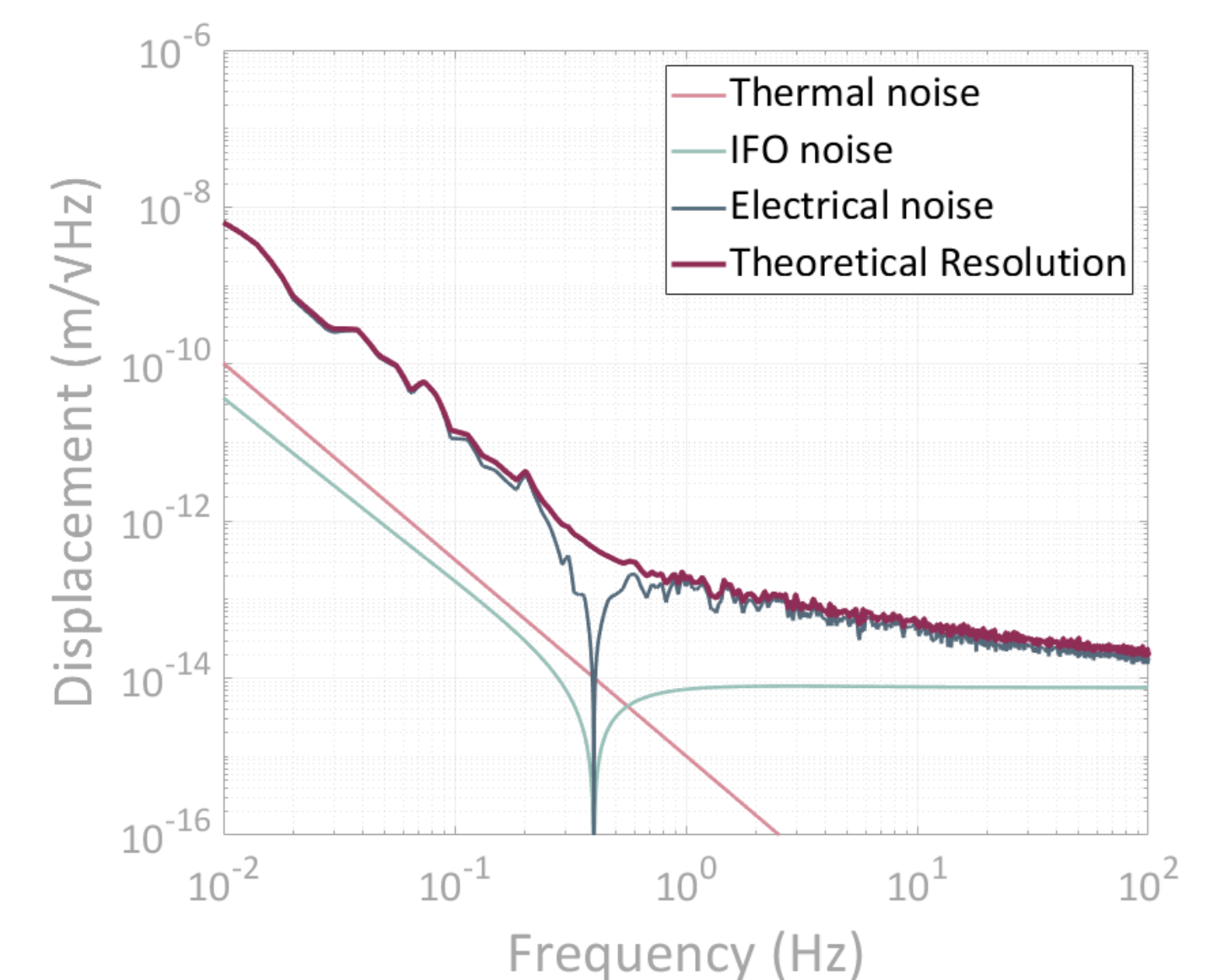

Sub pm/VHz from 1Hz

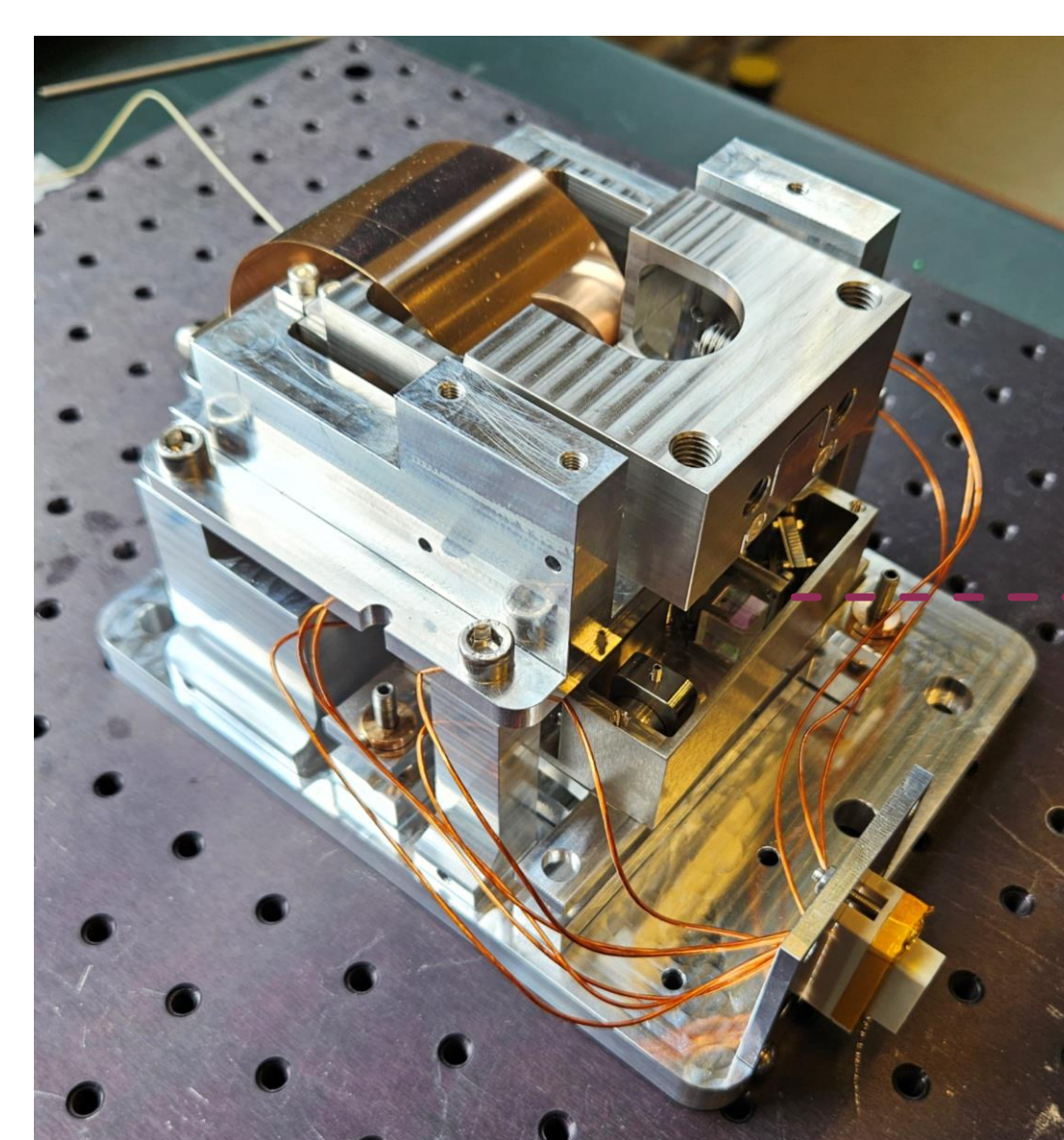

Open-loop

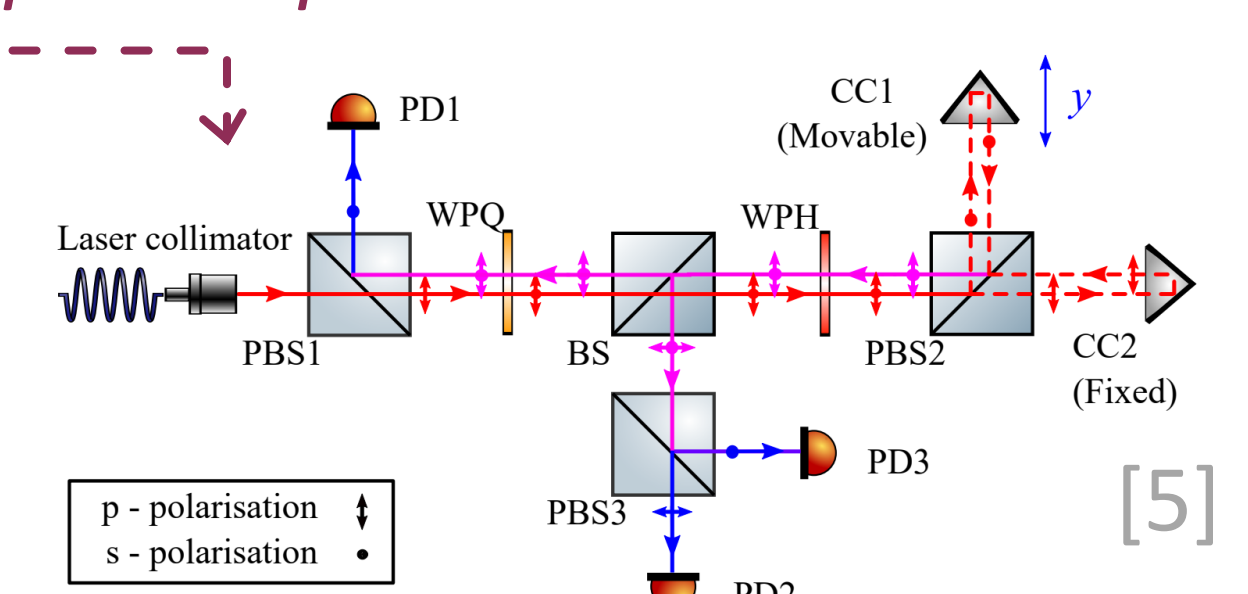

## What's next?

The compatibility and performance of the critical optical elements of interferometric readouts were investigated under cryogenic conditions. These findings were applied in E-TEST to develop fm/VHz sensitive inertial sensors to monitor the tenuous residual vibration at the cryogenic silicon mirror level. The presented research is also part of the payload development of the Lunar Gravitational-Wave antenna [6,7].