



THERMODYNAMICS LABORATORY
AEROSPACE AND MECHANICAL ENGINEERING
DEPARTMENT

FACULTY OF APPLIED SCIENCES
UNIVERSITY OF LIÈGE

**MODELLING THE INFLUENCE OF CLIMATE CHANGE ON HEATING,
COOLING ENERGY DEMANDS, THERMAL COMFORT, AND GHG
EMISSIONS FOR THE BUILDING STOCK IN BELGIUM**

Author

Essam ELNAGAR

THESIS SUBMITTED IN PARTIAL FULFILMENT OF THE REQUIREMENTS FOR THE
DEGREE OF *DOCTOR OF PHILOSOPHY IN APPLIED SCIENCES*

Liège, December 2023

Modelling the Influence of Climate Change on Heating, Cooling Energy Demands, Thermal Comfort, and GHG Emissions for the Building Stock in Belgium

Members of the Examination Committee:

Prof. Dr. Vincent LEMORT, Supervisor
(University of Liège, Belgium)

Prof. Dr. Shady ATTIA
(University of Liège, Belgium)

Prof. Dr. Anne-Claude ROMAIN
(University of Liège, Belgium)

Prof. Dr. Philippe ANDRE
(University of Liège, Belgium)

Prof. Dr. Mohamed HAMDY
(Norwegian University of Science and Technology, Norway)

Prof. Dr. Stefen Petersen
(Aarhus University, Denmark)

I dedicate this work to the memory of my dear father, whose presence I deeply miss every day. To my cherished wife, who stands by me through thick and thin, and to my loving mother and sister, who have been pillars of strength and support throughout this journey.

أهدي هذه الرسالة إلى ذكرى والدي العزيز، الذي أفتقد وجوده بشدة كل يوم. إلى زوجتي العزيزة، التي تقف بجانبني في السراء والضراء، وإلى أمي وأختي، الذين كانوا أعمدة القوة والدعم طوال هذه الرحلة.

Acknowledgement

First and foremost, I extend my heartfelt gratitude to my supervisor, Prof. Dr. Vincent Lemort. Our relationship over the years transcended the conventional student-supervisor dynamic; Vincent became akin to an older brother. His consistent understanding, flexibility, and unwavering support made my Ph.D. journey a memorable one. The knowledge I've garnered from Vincent over these four years has been invaluable.

I wish to convey my sincere appreciation to my committee members. A special mention to Prof. Dr. Shady Attia, whose influence in this work has been paramount. Shady's continual feedback, constructive comments, and dedicated meetings have significantly contributed to the culmination of my Ph.D. Prof. Dr. Anne Claude Romain, thank you for your insightful comments during our committee meetings over the years. I also extend my gratitude to Prof. Dr. Philippe Andre, Prof. Dr. Mohamed Hamdy, and Prof. Dr. Stefen Petersen. Your rich research has always been an inspiration. Thank you for dedicating your time and effort to my journey.

I'm deeply thankful to Simon Pezzutto and all colleagues at EURAC Research Institute in Italy. My research stay with you was filled with knowledge, insights, and incredible experiences. Your hospitality and collaborative spirit have significantly enriched my academic journey.

My profound thanks go to the University of Liège and the Walloon Region for their generous funding under the call 'Actions de Recherche Concertées 2019 (ARC)' (funding number: ARC 19/23-05) and the project OCCuPANt. This support has been the cornerstone that allowed our research to flourish. I also want to express my gratitude to the International Energy Agency (IEA) EBC Annex 80 – “Resilient cooling of buildings” project. Being a part of such a prestigious research team has been an enlightening experience. Dr. Peter Holzer and Philipp Stern, your leadership and mentorship have been exceptional. I extend my thanks to everyone associated with both these projects; your collective efforts have been pivotal to their success.

Family is the bedrock upon which all our endeavors stand. To my father, every accomplishment is a tribute to your memory; I wish you were here with us. To my wife, words might fall short to express my gratitude for your enduring love and unwavering support throughout this journey. Your belief in me has been my driving force. To my mother and sister, your unwavering support has been my anchor since day one.

I wish to convey my appreciation to the members of the LaboThAp team. Our camaraderie over the years has been as cherished colleagues and dear friends. A special shoutout to Sam, Cami, Javier, Nico, Alanis, Mazarine, and many more. My heartfelt thanks to all the technicians who have been an integral part of this journey. I am also grateful to my colleagues from the OCCuPANt project, especially Ramin, for his collaboration. Sebastien, Mohsen, and Deepak, thank you for being part of this expedition.

This journey, while academically enriching, has also been a lesson in kindness, collaboration, and perseverance. I am grateful for each one of you who has been a part of it.

Table of Contents

SUMMARY	8
ABBREVIATIONS	10
1. INTRODUCTION	12
1.1. SETTING THE STAGE: UNDERSTANDING CLIMATE CHANGE AND BUILDING ENERGY DYNAMICS	12
1.1.1. Climate change resonance: understanding the relation between building energy needs and the environment	15
1.1.2. A Balancing act: navigating thermal comfort	17
1.1.3. Building stock: modelling the building stock	17
1.2. PROBLEM STATEMENT	18
2. Conceptual Framework	24
2.1. OBJECTIVES AND RESEARCH QUESTIONS	24
2.2. THESIS STRUCTURE	26
2.3. INTEGRATION OF METHODOLOGICAL APPROACHES	28
3. SCHOLARLY PUBLICATIONS	35
CHAPTER 01: A COMPREHENSIVE SCOUTING OF SPACE COOLING TECHNOLOGIES IN EUROPE: KEY CHARACTERISTICS AND DEVELOPMENT TRENDS.	36
CHAPTER 02: A QUALITATIVE ASSESSMENT OF INTEGRATED ACTIVE COOLING SYSTEMS: A REVIEW WITH A FOCUS ON SYSTEM FLEXIBILITY AND CLIMATE RESILIENCE.	37
CHAPTER 03: HISTORICAL AND FUTURE WEATHER DATA FOR DYNAMIC BUILDING SIMULATIONS IN BELGIUM USING THE REGIONAL CLIMATE MODEL MAR: TYPICAL AND EXTREME METEOROLOGICAL YEAR AND HEATWAVES.	38
CHAPTER 04: FRAMEWORK TO ASSESS CLIMATE CHANGE IMPACT ON HEATING AND COOLING ENERGY DEMANDS IN BUILDING STOCK: A CASE STUDY OF BELGIUM IN 2050 AND 2100.	39
CHAPTER 05: APPLICATION OF INTEGRATING RESILIENT COOLING TECHNOLOGIES IN BUILDING STOCK: IMPACT ON THERMAL COMFORT, FINAL ENERGY CONSUMPTION, AND GHG EMISSIONS.	40
CHAPTER 06: IMPACT OF INTEGRATION OF ELECTRIC AND GAS HEAT PUMPS ON THE FINAL ENERGY CONSUMPTION OF BELGIAN RESIDENTIAL BUILDING STOCK.	41
4. DISCUSSION	42
5. CONCLUSION	50
5.1. REVISITING THE RESEARCH QUESTIONS	51
5.2. CONTRIBUTION OF THE THESIS	57
5.3. RECOGNIZING LIMITATIONS	58
5.4. PATHS FOR FUTURE RESEARCH	60
REFERENCES	61
APPENDICES	69
APPENDIX A	70
APPENDIX B	89
APPENDIX C	107
APPENDIX D	121
APPENDIX E	146
APPENDIX F	147

Summary

This Ph.D. thesis is a comprehensive exploration of the impact of climate change on heating and cooling energy demands, final energy consumption, thermal comfort, and greenhouse gas emissions for residential buildings in Belgium. It encompasses both short-term (recurrent heatwaves) and long-term (global warming) climate change effects, with a specific focus on cooling systems. The research employs a simulation/numerical model, adopting a bottom-up approach to characterize the Belgian residential building stock. The thesis is divided into three main parts, each addressing critical aspects of the research:

Part 1 - Cooling Systems Review and Data Collection: In this section, two extensive studies delve into cooling technologies in Europe. The first chapter categorizes and analyzes alternative space cooling methods, highlighting the need for further development to enhance their efficiency and cost-effectiveness. The second chapter focuses on integrated active cooling systems, evaluating their resilience to challenges such as heatwaves and power outages.

Part 2 - Methodological Framework: This part lays the foundation for the thesis, comprising two key studies. The first study deals with the creation of weather data, an essential component for understanding climate impacts. The second study establishes the framework used throughout the thesis to calculate heating and cooling energy needs under various weather scenarios.

Part 3 - Application and Data Analysis: This section encompasses two pivotal studies. The first explores the practical application of resilient cooling systems within the building stock, emphasizing adaptable solutions in response to changing climate conditions. The second assesses the integration of both electricity-driven and gas-driven heat pumps into the building stock, examining their impact on energy consumption.

The following provides a concise summary of vital practical insights and recommendations derived from the research:

- **Alternative Cooling Technologies:** Several alternative cooling technologies show promise in terms of energy efficiency and sustainability, but they may face challenges compared to conventional vapor compression systems. Policy support is essential to promote their adoption.
- **Resilience to Heatwaves:** Thermal energy-driven cooling systems exhibit greater resilience to heatwaves compared to some electricity-driven systems. This resilience is influenced by factors like system integration with renewable energy sources.
- **Impact of Climate Change:** Climate change is expected to lead to a significant increase in cooling energy demand and a decrease in heating energy demand in the Belgian building stock. The intensity

and frequency of heatwaves are projected to rise significantly in the future.

- **Thermal Comfort:** Thermal comfort can be significantly impacted by climate change. Resizing split cooling systems based on peak heatwave temperatures can enhance indoor thermal comfort.
- **Integration of Heat Pumps:** The integration of heat pump technologies can reduce energy consumption and greenhouse gas emissions in the residential building stock. Both electricity-driven and gas-driven heat pumps offer viable options for achieving these benefits.

Overall, the thesis highlights the need for proactive measures to address the challenges posed by climate change on the Belgian residential building stock. Sustainable cooling technologies, resilient strategies, and the integration of heat pumps are essential components of a comprehensive approach to building sustainability and climate adaptation.

Abbreviations

AC	Active Cooling / Air Conditioners / Air conditioning
BAU	Business-As-Usual
BCC-CSM2- MR	Beijing Climate Center Climate System Model version 2 Medium Resolution
CMIP6	Sixth Coupled Model Intercomparison Project
COP	Coefficient of Performance
COPD	Chronic Obstructive Pulmonary Disease
CO ₂	Carbon Dioxide
DHW	Domestic Hot Water
EEA	European Environment Agency
EER	Energy Efficiency Ratio
ERA5	Fifth generation of ECMWF Atmospheric Reanalyses
ESMs	Earth System Models
EU	European Union
FCUs	Fan Coil Units
GAHP	Gas-Driven Absorption Heat Pump
GHG	Greenhouse Gas
HVAC	Heating, Ventilation, and Air Conditioning
HWE	Heatwave Event
IAQ	Indoor Air Quality
IOhD	Indoor Overheating Degree
IOpT	Indoor Operative Temperature
IPCC	Intergovernmental Panel on Climate Change
ISO	International Organization for Standardization
MAR	Modèle Atmosphérique Régional
MIROC6	Model for Interdisciplinary Research On Climate version 6
MPI- ESM.1.2	Max Planck Institute Earth System Model version 1.2
MV	Mechanical Ventilation
NG	Natural Gas
NV	Natural Ventilation
PMV	Predicted Mean Vote
PV	Photovoltaic
RMI	Royal Meteorological Institute
RQ	Research Question
SC	Space Cooling
SEER	Seasonal Energy Efficiency Ratio
SH	Space Heating
SLPs	Synthetic Load Profiles
SSP	Shared Socioeconomic Pathway
TDHP	Thermally-Driven Heat Pump
TMY	Typical Meteorological Year
TRL	Technology Readiness Level

U-value	Thermal Transmittance Value
UHI	Urban Heat Island
UNFCCC	United Nations Framework Convention on Climate Change
VC	Vapor Compression
VRF	Variable Refrigerant Flow
WMO	World Meteorological Organization
XMY	Extreme Meteorological Year

1. Introduction

1.1. Setting the stage: understanding climate change and building energy dynamics

Global perspective of climate change

- **The warming world:**

The 20th and 21st centuries have seen an unprecedented increase in global temperatures. According to the Intergovernmental Panel on Climate Change (IPCC), the period between 1850 and 1900 serves as the reference timeframe for pre-industrial temperatures. Since 1880, Earth's average temperature has increased by approximately 1.1°C, with a rate of 0.08°C per decade. From 1981 onwards, this rate accelerated to 0.18°C per decade. 2022 was the sixth warmest year on record, being 0.86°C above the 20th-century average. It was 0.13°C cooler than the 2016 record and 0.02°C warmer than 2021 (the seventh highest). All of the top 10 warmest years have occurred post-2010 as shown in Figure 1.1. This escalation in temperatures is largely attributed to human activities, notably the emission of greenhouse gases (GHGs). The primary GHG, carbon dioxide (CO₂), has witnessed a marked increase in its atmospheric concentration, soaring from pre-industrial levels of around 280 ppm to exceed 410 ppm in recent decades. The main contributors to this increase are the combustion of fossil fuels, widespread deforestation, and certain industrial activities [1–4].

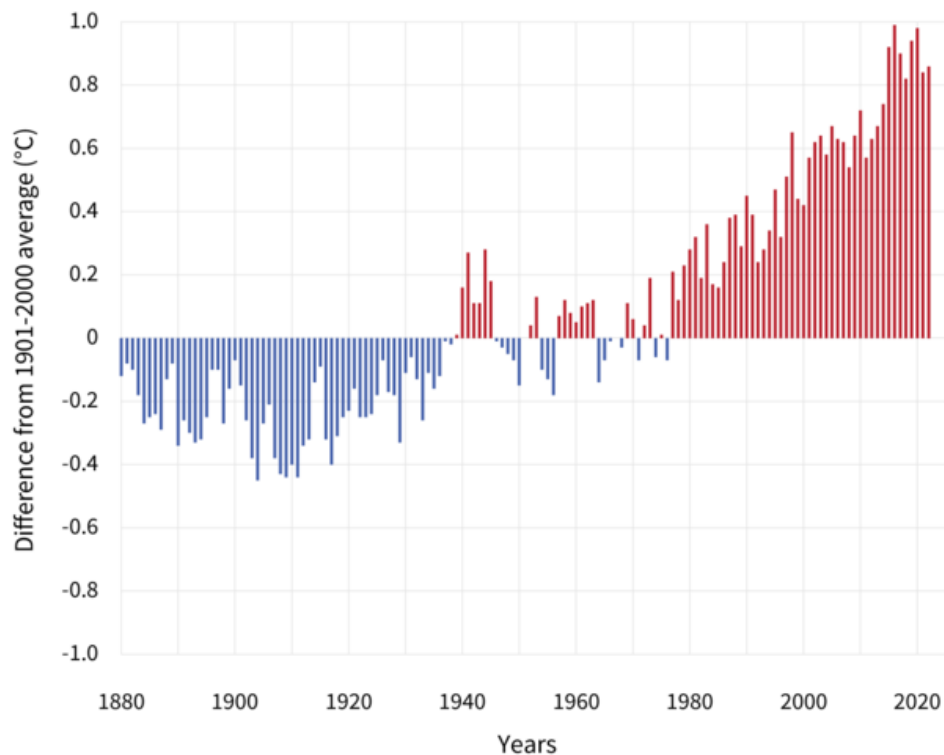

Figure 1.1. Global average surface temperature [5]

- **Weather extremes:**

The rise in global temperatures has been accompanied by a more frequent occurrence of extreme weather events. The World Meteorological Organization (WMO) and various studies indicate that these events are growing in both intensity and frequency. For instance, Category 4 and 5 hurricanes have increased in frequency since the 1980s, and the global frequency of droughts has increased since the early 1900s [6]. Additionally, the occurrence of heavy precipitation events has surged in numerous regions, leading to frequent and intense flooding. Wildfires, which are influenced by droughts and prolonged high temperatures, have also seen a rise in occurrence and intensity. These events are not just mere coincidences but are indeed glaring symptoms of broader climate changes and have consequential impacts on ecosystems, human settlements, and economies [7]. Figure 1.2 from the Met Office, based on data from MunichRE dataset shows the evolving trend in extreme events from 1980 to 2019 [8]. It categorizes these events into four distinct groups: geophysical events (e.g., earthquakes, tsunamis, volcanic activities), meteorological events (e.g., tropical storms, extratropical storms, local storms), hydrological events (e.g., floods, mass movements), and climatological events (e.g., extreme temperatures, droughts, wildfires). A clear upward trajectory in the frequency of these events can be observed, especially post-2000, with meteorological and hydrological events showing the most pronounced increase. The sharp rise in such extreme events underscores the pressing implications of climate change and the urgent need for adaptive measures.

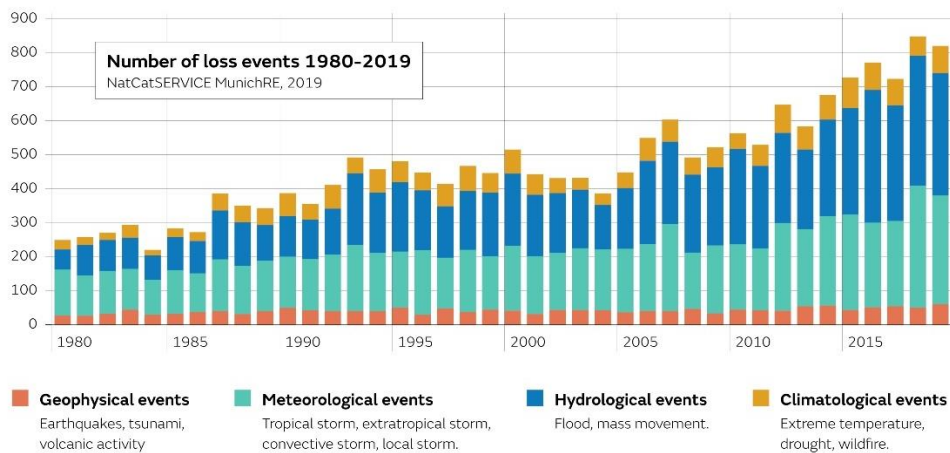

Figure 1.2. Frequency of the loss events and its relation to climate change [8]

Europe perspective of climate change

In recent years, Europe has witnessed a discernible intensification in climate change-related manifestations, underscored by robust scientific evidence elucidating shifts in temperature, precipitation patterns, and extreme weather events. A precise examination of climate findings reveals a stark trend of temperature escalation across the continent. According to the European Environment Agency (EEA) [9], the past decade, from 2013 to 2022, has been recorded as the warmest in history, with global mean near-surface temperatures

registering an increase of 1.13 to 1.17°C above pre-industrial levels. This warming trend is even more pronounced in Europe, where land temperatures have surged by 2.04 to 2.10°C, contingent upon the dataset analyzed. Under the Paris Agreement, nations under the United Nations Framework Convention on Climate Change (UNFCCC) have pledged to cap the global temperature rise at well below 2°C above pre-industrial levels [10], aspiring to further restrict this increase to 1.5°C. However, if the current trajectory of global greenhouse gas emissions persists unabated, projections indicate that the 2°C threshold is likely to be surpassed before the year 2050 [11–13].

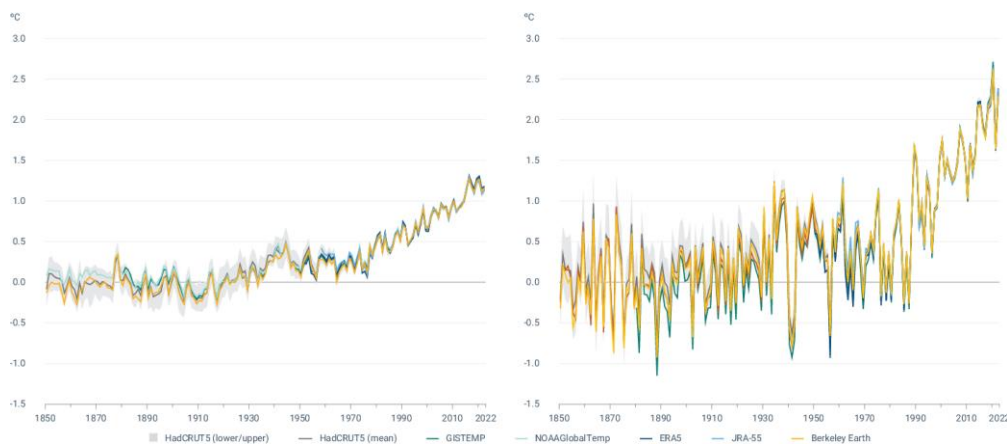

Figure 1.3. Global (left) and European (right) annual average near-surface temperature anomalies relative to the pre-industrial period 1850-1900 [9]

Extreme weather events have also seen an uptick in both frequency and intensity. Europe has borne witness to an increased incidence of heatwaves, forest fires, and storms. For instance, the catastrophic heatwaves in 2003 and 2018 stand as stark testimonies to the escalating ramifications of climate change. Moreover, the incidence of forest fires in Mediterranean countries has shown an upward trajectory, a trend that can be attributed to higher temperatures and decreased precipitation.

The aforementioned observations regarding the escalating global mean near-surface temperatures, and the even more accelerated increase in European land temperatures, underscore the critical need for strategic planning and policy implementation to mitigate climate change's impacts. The urgency of the situation is further accentuated by the potential surpassing of the 2°C threshold set by the Paris Agreement before 2050, if current greenhouse gas emissions remain unchecked. In this context, Shared Socioeconomic Pathways (SSPs) emerge as instrumental tools that facilitate a nuanced understanding of the various trajectories that global development might take, considering both the challenges to mitigation and adaptation efforts.

SSPs are essentially a set of scenarios developed to explore different ways in which the world might evolve in the absence of climate policy intervention, and how these could influence global greenhouse gas emissions and adaptability to climatic changes. They are designed to offer a comprehensive framework that aligns socio-economic factors with possible future climate outcomes. By examining various pathways, policymakers and researchers can

anticipate the potential repercussions of distinct socio-economic developments and devise strategies accordingly.

SSP1, titled "Sustainability – Taking the Green Road", aims to create a sustainable and equitable future, where concerted efforts towards adaptation and mitigation may restrict warming to around 1.5°C above pre-industrial levels. **SSP2**, or "Middle of the Road", envisions a continuation of current trends, resulting in moderate socio-economic development and a potential global warming of approximately 2.0°C to 3.0°C. **SSP3**, known as "Regional Rivalry – A Rocky Road", posits a world fragmented by regional interests, leading to significant hurdles in climate mitigation and adaptation, potentially resulting in a warming exceeding 3.5°C. **SSP4**, "Inequality – A Road Divided", explores a scenario characterized by stark disparities, where a privileged minority enjoys progress while the majority faces increased vulnerability to warming, which might fall between 2.4°C and 4.5°C. Lastly, **SSP5**, "Fossil-fueled Development – Taking the Highway", emphasizes rapid, fossil-fuel-driven growth, potentially leading to substantial warming, possibly in excess of 4.0°C. Each SSP aims to provide insights into different facets of societal and climate evolution, allowing for comprehensive assessments and strategic planning [14–16].

1.1.1. Climate change resonance: understanding the relation between building energy needs and the environment

It is crucial to narrow our focus to specific sectors impacted by these changes. One important area to explore is how climate change directly influences the energy requirements of buildings, a concept known as 'climate change resonance'. This concept helps us understand how shifts in climate, such as changes in temperature and weather patterns, can affect the energy that buildings need for heating, cooling, and other parameters such as the air pollution impact. For example, a warmer climate might mean increased use of air conditioning, while milder winters could reduce heating needs [17,18]. By examining climate change resonance, we can gain insights into designing buildings that are more energy-efficient and resilient to changing conditions.

Figure 1.4 illustrates the interconnected feedback loop between society's energy demand, the impact of climate change, and air pollution responses.

Energy demand and climate change impact:

- As society's demand for energy grows, primarily if driven by fossil fuels, this directly contributes to greenhouse gas emissions. These emissions, in turn, accelerate the impacts of climate change.
- The consequences of climate change, such as increasing temperatures, can lead to a further rise in energy demand, particularly in regions that become hotter, thus necessitating more cooling. This forms a vicious cycle where increased energy demand exacerbates climate change impacts, which in turn pushes the energy demand even higher [19–21].

Energy demand and air pollution:

- The same energy sources, especially the burning of fossil fuels, release pollutants into the atmosphere. These pollutants contribute to poor air

quality, leading to a range of health problems for the population and negatively impacting ecosystems.

- As air quality deteriorates, there might be increased energy demands in specific sectors. For instance, buildings might need advanced HVAC systems to filter out pollutants, requiring more energy.

Adaptation to climate change and air pollution:

- The figure also emphasizes the importance of adaptation, both to the impacts of climate change and to the challenges posed by air pollution. While these adaptation measures are crucial for society's resilience, they too can influence energy demand. For instance, building infrastructures resilient to extreme weather events might necessitate more energy-intensive materials or processes [22,23].
- Moreover, adapting to air pollution, say through the widespread use of air purifiers in urban areas, also has an energy cost.

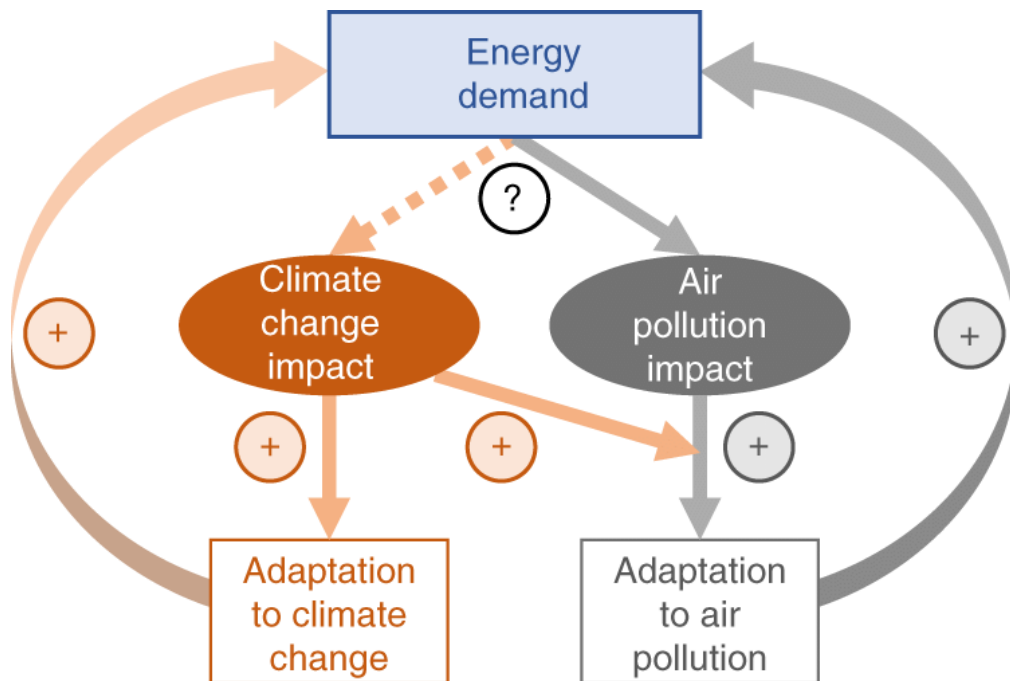

Figure 1.4. The feedback loop of energy demand, impact of climate change and air pollution, and resulting energy-intensive adaptation. (the solid arrows and the dashed arrows indicate the direction of immediate versus relatively distant influences, respectively. The plus symbols indicate positive relations, and the question mark represents the possibility of lessening the feedback loop from decarbonizing the power sector) [24]

Several studies investigated how the interplay of climate change and air pollutants. A study by Tagaris et al. [25] examined how the interplay of climate change and air pollutants, specifically ozone and particulate matter, can influence public health. Using modeling, they project increased premature mortality in the Eastern United States due to exacerbated air pollution stemming from climate change

The question mark in the feedback loop between energy demand and air pollution impact indicates that the relationship is complex and might not be linear. The exact nature of this relationship can be contingent on various factors, including technological advances, policy interventions, and societal behaviors.

Having discussed the intricate feedback loops between energy demand, climate change, and air pollution, an appreciation emerges for the multifaceted challenges society faces in creating sustainable living environments. At the nexus of these challenges lies the concept of thermal comfort.

1.1.2. A Balancing act: navigating thermal comfort

Thermal comfort refers to the condition of mind that expresses satisfaction with the surrounding environment's thermal environment [26–28]. It represents a delicate balance and is crucial for both well-being and productivity. Achieving and maintaining thermal comfort is not a straightforward task, especially in the context of the ever-changing climate.

Factors such as air temperature, humidity, air velocity, and mean radiant temperature influence an individual's perception of thermal comfort. Personal factors, including clothing insulation and metabolic rate, also play a role [29–32]. With global temperatures on the rise, ensuring thermal comfort becomes increasingly challenging. The need for cooling in summers might increase, while the heating needs during milder winters might decrease, thereby influencing energy demands.

A study by Fanger [33] introduced the Predicted Mean Vote (PMV) model, which takes into account these variables to predict the average comfort vote of a large group of people on a seven-point thermal sensation scale. This research underscored the importance of considering a combination of factors to ensure optimal comfort. With global temperatures witnessing an upward trend, there's a growing emphasis on adaptive approaches. De Dear and Brager [34] explored adaptive thermal comfort standards in the evolving ecological paradigm. Their study, published in *Energy and Buildings*, observed that individuals adapted their thermal preferences based on prevailing outdoor conditions, underscoring the dynamic nature of thermal comfort [37].

Given the environmental repercussions of excessive energy consumption, it becomes imperative to strike a balance. Innovative building designs that incorporate passive cooling and heating strategies, high-quality insulation, and energy-efficient HVAC systems can offer solutions [35–38]. Furthermore, understanding local climate conditions and integrating renewable energy sources can further aid in navigating this balance.

1.1.3. Building stock: modelling the building stock

While understanding individual thermal comfort is essential, the broader implications of climate change on energy use and comfort extend to entire buildings and even entire cities or regions. The type, age, design, and construction materials of a building can significantly influence how it responds to external temperature fluctuations. Moreover, buildings clustered together in urban environments create microclimates, which can further influence indoor comfort levels. As such, to get a comprehensive understanding of how climate

change will impact energy demands and thermal comfort, it's essential to consider the entire building stock.

Building stock modeling provides a macroscopic perspective, offering insights into the collective impact of climate change on a larger scale. By assessing diverse building types and their status, this modeling can pinpoint specific vulnerabilities and opportunities in the built environment. For instance, older buildings might lack modern insulation or energy-efficient systems, making them more susceptible to changing climatic conditions. On the other hand, newer, green-certified structures might be better equipped to handle these shifts. By examining the building stock as a whole, policymakers and stakeholders can devise strategies that address the nuanced challenges posed by climate change, ensuring energy efficiency and comfort across a wider spectrum [39–45].

The approach to this modeling can significantly vary, primarily branching into two methodologies: the top-down and bottom-up approaches [46,47]. Each has its unique features, advantages, and limitations. The top-down approach starts with macro-level data, often from national or regional statistics, and allocates this data to specific building types or sectors, providing a broad overview suitable for overarching policies [48,49]. In contrast, the bottom-up approach begins at the micro-level, analyzing individual buildings or specific types, then aggregates these findings for a comprehensive view [47]. This method offers detailed insights, capturing the diversity of building characteristics and occupant behaviors, ideal for precise interventions [50]. While the top-down approach is quicker and requires less granular data, making it apt for broader strategies, the bottom-up approach, though more resource-intensive, is prized for its accuracy and granularity [51]. Often, a fusion of both approaches can yield the most holistic understanding of a building stock's energy implications.

1.2. Problem statement

In the wake of the 21st century, our world is facing a formidable challenge that threatens the very fabric of our existence – global warming and climate change. The findings presented in the IPCC report project a significant potential increase in the average global surface air temperature. These projections encompass a range of 1 to 5.7°C over the period from 2081 to 2100, relative to the pre-industrial reference period of 1850-1900 [1,2]. The consequences of these phenomena reach far and wide, impacting not only the vast expanse of our natural environment but also the most intimate spaces of our daily lives, namely, our buildings. As global temperatures surge to unprecedented levels, the building sector stands as both a victim and a contributor to this climatic dilemma.

Global warming, caused by the continuous rise in GHG emissions, has brought about noticeable changes in our climate. One of the most noticeable aspects of climate change is the increase in temperatures. Urban areas, where a large number of people live, are particularly susceptible to this warming trend. They often face specific climate changes that make the overall global shift even more challenging. This includes higher temperatures, more frequent heatwaves, and changes in rainfall patterns, which are now common topics in our everyday conversations.

The effects of global warming are significantly pronounced within the constructed environment. Long-lasting heatwaves, which are a clear sign of climate change, greatly affect the comfort inside our buildings. Inadequate building designs to handle extreme heat result in overheating, making these structures uncomfortable and sometimes unsuitable for habitation. As we increasingly rely on mechanical cooling systems to combat the heat, our energy use rises, leading to even more greenhouse gas emissions. This creates a harmful cycle, contributing to further climate change issues.

The impacts of overheating in the building sector go far beyond making people uncomfortable. It has profound effects on the health and well-being of the occupants. Being exposed to extreme heat not only poses immediate health risks but can also result in long-term health problems. Vulnerable populations, including the elderly and those with preexisting health issues, are particularly at risk. Additionally, indoor air quality within these overheated buildings is compromised, posing health risks to the occupants.

Figure 1.5 serves as a comprehensive visual representation of the multifaceted impacts of climate change. This figure shows the main drivers of climate change, including the notable factors of increased global temperatures, extreme weather conditions, precipitation extremes, sea level rise, and changes in land use. It prominently underscores the pivotal role these drivers play in shaping the global climate landscape.

Furthermore, it shows the primary effects of climate change across various sectors. These encompass extreme heat, exacerbating heat-related illnesses and heat stress, while also delving into issues of air and water pollution that detrimentally affect environmental and public health. The figure underscores the challenges related to food and water scarcity, changes in patterns of infectious diseases, and the profound economic losses incurred as a consequence of these changes. It illuminates the complex web of climate-induced impacts, from health issues to economic implications, affecting both local and global scales.

Additionally, the distinct effects witnessed within the building sector include the increased cooling demands, necessitating energy-intensive solutions, as well as the growing need for retrofitting and adaptation of existing structures to withstand extreme conditions. The impact of climate change on reduced indoor air quality and the imperative role of energy efficiency standards in mitigating these concerns are also featured prominently.

Lastly, it emphasizes the health impacts arising from climate change, shedding light on the increased incidence of heat-related illnesses, respiratory problems, allergies, and mental health issues. The vulnerability of specific populations to these health challenges is evident, underscoring the need for targeted strategies to safeguard public well-being.

CLIMATE CHANGE	EFFECTS OF CLIMATE CHANGE	EFFECTS IN BUILDING SECTOR	HEALTH IMPACTS
Increased Global Temperature	Extreme Heat	Increased Cooling Demand	Heat-Related Illnesses
Extreme Weather Conditions	Air and Water Pollution	Heat Stress	Respiratory Problems
Precipitation Extremes	Food and Water Scarcity	Retrofit and Adaptation	Allergies
Sea Level Rise	Changes in Infectious Diseases	Reduced Indoor Air Quality	Mental Health Impacts
Changes in Land Use	Economic Losses	Energy Efficiency Standards	Vulnerable Populations

Figure 1.5. Impacts of climate change

Effects of climate change:

Extreme heat: Climate change is unequivocally driving an increase in extreme heat events. Rising global temperatures intensify heatwaves, posing severe health risks and discomfort for populations. Studies have shown that these heatwaves are becoming more frequent and prolonged, endangering vulnerable communities. A previous study showed that the number of extreme heatwave days increased by over 50% in the last half-century, with alarming implications for public health [52]. Another study emphasized that several regions experienced an alarming increase in the number of heatwave days, exacerbating the impact of extreme heat [53]

Air and water pollution: Climate change contributes to the degradation of air and water quality. Increasing temperatures exacerbate air pollution, resulting in adverse health effects, especially in urban areas. Additionally, altered precipitation patterns can impact water quality, increasing the risk of waterborne diseases. The sources of air and water pollution are diverse, encompassing emissions from industrial processes and changes in land use. Recent research emphasizes the exacerbation of air pollution and the need for improved air quality standards. Several studies showed that air pollution due to climate change adversely affects respiratory health and air pollution levels are expected to increase and urged for the enhancement of air quality standards to safeguard public health [54–56].

Food and Water Scarcity: Climate change disrupts food production and water resources. Variability in precipitation patterns and prolonged droughts lead to water scarcity, affecting agriculture. Food security is threatened, and malnutrition risks increase, especially in regions reliant on rainfed agriculture.

Recent studies highlight the impact on water resources and the need for sustainable water management strategies. A previous study showed that climate change could reduce crop yields by up to 25% and put 25 million more children at risk of malnutrition by 2050 [57].

Changes in infectious diseases: Climate change significantly impacts the spread of infectious diseases by altering temperature and precipitation patterns, influencing the habitat range of disease vectors. This phenomenon has serious health implications, with diseases such as malaria and dengue expanding into new regions. Recent research has provided valuable insights into this connection between climate change and the proliferation of infectious diseases, highlighting the need for proactive measures. Furthermore, a review published in "Nature Climate Change" in 2022 demonstrated that over half of all infectious diseases are exacerbated by climate change [58]. It revealed that habitat disruptions caused by various climate-related factors, including warming, drought, heatwaves, wildfires, storms, floods, and land cover changes, are associated with the increased prevalence and spread of infectious diseases.

Economic losses: The economic implications of climate change are substantial. Extreme weather events, including hurricanes, floods, and wildfires, result in significant economic losses. Moreover, the costs of mitigating and adapting to climate change, along with the loss of productivity due to health impacts, create economic burdens on societies and nations. The Intergovernmental Panel on Climate Change (IPCC) reported in 2012 that global economic losses due to extreme weather events were doubling every decade. Recent economic assessments, such as the World Bank's 2020 report, "Economics of Adaptation to Climate Change," highlight the increasing financial toll of climate-related disasters and the need for substantial investments in adaptation and resilience measures [59].

Effects in building sector:

Increased cooling demand: As global temperatures rise, there is an increased demand for cooling in buildings to maintain comfortable living conditions. This leads to higher energy consumption, particularly in regions that traditionally did not require extensive cooling systems. The growing reliance on air conditioning not only puts a strain on energy grids but also contributes to higher greenhouse gas emissions [39,60,61].

Heat stress: Buildings, especially in urban areas, can experience heat stress due to increased ambient temperatures. This phenomenon is exacerbated by the urban heat island effect, where concrete structures and limited green spaces lead to higher local temperatures. Heat stress can impact the structural integrity of buildings, leading to faster degradation of materials and necessitating more frequent maintenance [62,63].

Retrofit and adaptation: To cope with the changing climate, existing buildings may need to undergo retrofitting and adaptation. This could include adding insulation, installing energy-efficient windows, or incorporating green roofing solutions to mitigate heat absorption [64,65]. Adaptation measures also involve considering resilience to extreme weather events, such as installing flood barriers in areas prone to flooding.

Reduced indoor air quality (IAQ): Climate change can lead to poorer indoor air quality due to increased levels of pollutants and allergens. Warmer conditions can foster the growth of mold and mildew, while increased use of air conditioning can lead to the recirculation of contaminants inside buildings. Ensuring proper ventilation and air filtration becomes crucial in maintaining a healthy indoor environment [66,67].

Energy efficiency standards: In response to climate change, there is a push towards implementing stricter energy efficiency standards for buildings. Governments and regulatory bodies are encouraging the construction industry to adopt sustainable practices, such as using energy-efficient appliances, incorporating renewable energy sources, and designing buildings with optimal thermal performance. These standards aim to reduce the overall carbon footprint of the building sector [68].

Health impacts:

Heat-related illnesses: Rising global temperatures linked to climate change are causing a surge in heat-related illnesses. Extreme heat events are becoming more frequent and severe, posing a direct threat to public health. Conditions like heatstroke, heat exhaustion, and heat cramps are on the rise. Vulnerable populations, including the elderly, children, and outdoor workers, face elevated risks due to prolonged exposure to high temperatures [69].

Respiratory problems: Climate change is impacting respiratory health by worsening air quality. Increasing temperatures and higher levels of air pollution exacerbate respiratory conditions such as asthma and chronic obstructive pulmonary disease (COPD). Research reveals that higher temperatures and elevated ground-level ozone levels lead to more frequent and severe respiratory distress, particularly in urban areas. This places an added burden on healthcare systems, necessitating strategies to mitigate air pollution and adapt to changing climate conditions [70,71].

Allergies: Climate change directly affects allergies by causing a proliferation of allergenic pollen. Elevated carbon dioxide levels and extended plant growing seasons result in increased pollen production and longer pollen seasons. This intensifies allergic reactions in individuals susceptible to pollen allergies. Several studies highlight the link between rising pollen levels and heightened allergy-related health issues, emphasizing the need for improved allergy management strategies [72,73].

Mental health impacts: Climate change's often-overlooked mental health impacts are increasingly evident. Exposure to natural disasters, displacement due to rising sea levels, and economic losses from extreme weather events can lead to a range of psychological issues, including anxiety, depression, and post-traumatic stress disorder (PTSD). Research underscores the psychological toll of climate-related events on individuals and communities, emphasizing the importance of addressing mental health as an integral part of climate adaptation and resilience efforts [74,75].

Vulnerable populations: Climate change disproportionately affects vulnerable populations, including low-income communities and minority groups. These communities often lack access to adequate healthcare, reside in areas

with poor air quality, and have limited resources to cope with extreme weather events. Studies emphasize the disparities in climate-related health impacts and the need for targeted interventions to protect these vulnerable communities [76,77].

In light of the global challenges posed by climate change and its profound impact on both the building sector and public health. The primary focus of this thesis is twofold: first, to conduct an extensive assessment of space cooling systems and explore alternative, environmentally friendly technologies that minimize their ecological footprint. Second, to tackle the challenge from a Belgian perspective by developing and proposing adaptation strategies for cooling systems deployed across the entire building stock in Belgium. Simultaneously, the thesis delves into retrofit strategies for the existing building stock to enhance energy efficiency and sustainability. By offering these solutions, the thesis encompasses key aspects, notably thermal comfort and indoor air quality, with the overarching goal of mitigating heat-related illnesses. Through this interdisciplinary approach, the thesis aims to contribute to the resilience and sustainability of Belgium's built environment in the face of climate change challenges.

2. Conceptual framework

2.1. Objectives and research questions

The objective of this Ph.D. thesis can be outlined as follows: (i) to quantitatively assess the impact of climate change, both short-term (recurrent heatwaves) and long-term (global warming), on heating and cooling energy demands, final energy consumption, thermal comfort, and GHG emissions for the Belgian residential building stock; (ii) with a specific focus on cooling systems, the study aims to fill the existing research gap in the realm of cooling, considering that a significant body of research already exists for heating systems. Therefore, the thesis includes a review and quantitative assessment of cooling system integration in residential buildings; (iii) following the review of cooling systems, the thesis assesses the impact of applying various resilient cooling strategies (both active and passive) into the building stock, recognizing the importance of adapting to changing climate conditions; (iv) the study incorporates uncertainty analysis, validation through synthetic load profiles, and the use of projected weather files to ensure the robustness of its findings in the face of climate and renovation uncertainties; (v) the study examines the impact of integrating electric and gas heat pumps on load profiles and final energy consumption; and (vi) the findings indicate significant changes in heating and cooling demands due to climate change, emphasizing the need for sustainable and energy-efficient cooling solutions to address this challenge.

The primary objective of this Ph.D. thesis is to comprehensively address this main research question:

- *What is the impact of climate change on the building stock in Belgium, particularly in terms of heating and cooling energy demands, thermal comfort, and GHG emissions, and how can this impact be effectively modeled and addressed by considering various HVAC technologies, with a specific focus on cooling systems in the summer season?*

The main research question is systematically divided into a series of sub-research questions, each designed to explore various gaps within the broader research topics. These sub-research questions serve as the focal points for a collection of six distinct scientific publications. Each publication delves into specific aspects of the main inquiry, contributing to a comprehensive understanding of the multifaceted challenges posed by climate change's impact on the building stock in Belgium. Together, these publications provide an intricate and thorough examination of the research area, offering valuable insights and solutions to the complex issues at hand. The sub-research questions are outlined as follows:

- **RQ1:** *What are the key characteristics and future development trends of space cooling technologies in Europe, and how can these trends inform sustainable cooling practices in response to increasing demand for cooling solutions? (Chapter 01 & Chapter 05)*

- **RQ2:** *How do integrated active cooling systems perform in terms of flexibility and climate resilience to heatwaves and power outages, and what implications does this have for their applications in buildings? (Chapter 02 & Chapter 05)*
- **RQ3:** *How can MAR model-generated weather datasets inform strategies for adapting to climate change in Belgium across various global SSP Scenarios? (Chapter 03, Chapter 04, Chapter 05 & Chapter 06)*
- **RQ4:** *How do heating and cooling energy demands in the building stock change by the end of the century in response to climate change, within a comprehensive framework that considers uncertainties related to climate and renovation? (Chapter 04, Chapter 05 & Chapter 06)*
- **RQ5:** *How do resilient cooling strategies affect thermal comfort, energy consumption, and GHG emissions in Belgian residential building stock? (Chapter 05)*
- **RQ6:** *What is the impact of integrating electric and gas heat pump technologies on the energy consumption and GHG emissions in the Belgian residential building stock? (Chapter 06)*

2.2. Thesis structure

The structure of the thesis is visually presented in Figure 2.1. Each chapter within these parts represents a journal or conference publication, contributing to the fulfillment of the primary research questions. Furthermore, every chapter addresses specific sub-research questions, elaborated upon within each publication.

The body of the thesis is strategically divided into three main parts. Part 1 is dedicated to the review and data collection about cooling systems. In this section, two comprehensive studies are conducted to explore cooling technologies in Europe, with a particular focus on qualitative analysis for integrated active cooling systems. The examination centers on their flexibility and resilience to challenges such as heatwaves and power outages. Part 2 encompasses the methodological framework, which includes two key studies. The first study revolves around the creation of weather data, an essential component in understanding climate impacts. The second study establishes the framework used throughout the thesis to calculate the heating and cooling energy needs under various weather scenarios. In Part 3, which is dedicated to application and data analysis, two pivotal studies are conducted. The first study delves into the practical application of resilient cooling systems within the building stock, addressing the need for adaptable solutions in the face of changing climate conditions. The second study assesses the integration of both electricity-driven and gas-driven heat pumps into the building stock, exploring how these systems impact energy consumption.

Chapter 01 presents a thorough examination of space cooling technologies in Europe. It categorizes 32 alternative space cooling methods, analyzing their key characteristics and development trends. The findings emphasize the need for further research and development to enhance the efficiency, cost-effectiveness, and competitiveness of alternative space cooling technologies. In Chapter 02, the focus shifts to integrated active cooling systems. It reviews and classifies these systems based on parameters such as energy source, flexibility, and climate resilience. This chapter identifies the resilience of electricity-driven systems to heatwaves and highlights the importance of integrating cooling strategies with secondary systems. Chapter 03 delves into historical and future weather data. It provides essential meteorological data that influence building practices in the context of global warming. The chapter emphasizes the significance of projected weather data for designing and managing energy-efficient buildings. Chapter 04 investigates the impact of climate change on heating and cooling energy demands in Belgian building stock. It showcases the need for adaptive strategies in response to the growing demand for space cooling. The study demonstrates the potential changes in energy demands due to climate shifts, emphasizing the role of retrofit strategies. Chapter 05 explores the application of resilient cooling technologies in the building stock. It highlights the alarming temperature increases and the need for effective strategies to combat extreme heatwaves. The chapter discusses various cooling scenarios, their impacts on thermal comfort, energy consumption, and GHG emissions, underscoring the importance of sustainable cooling solutions. Chapter 06 focuses on the integration of electric and gas heat

pumps for heating in the Belgian building stock. It presents scenarios for the evolution of these technologies based on building envelope changes. The study provides penetration rates for different heat pumps, offering valuable insights for energy suppliers and policymakers.

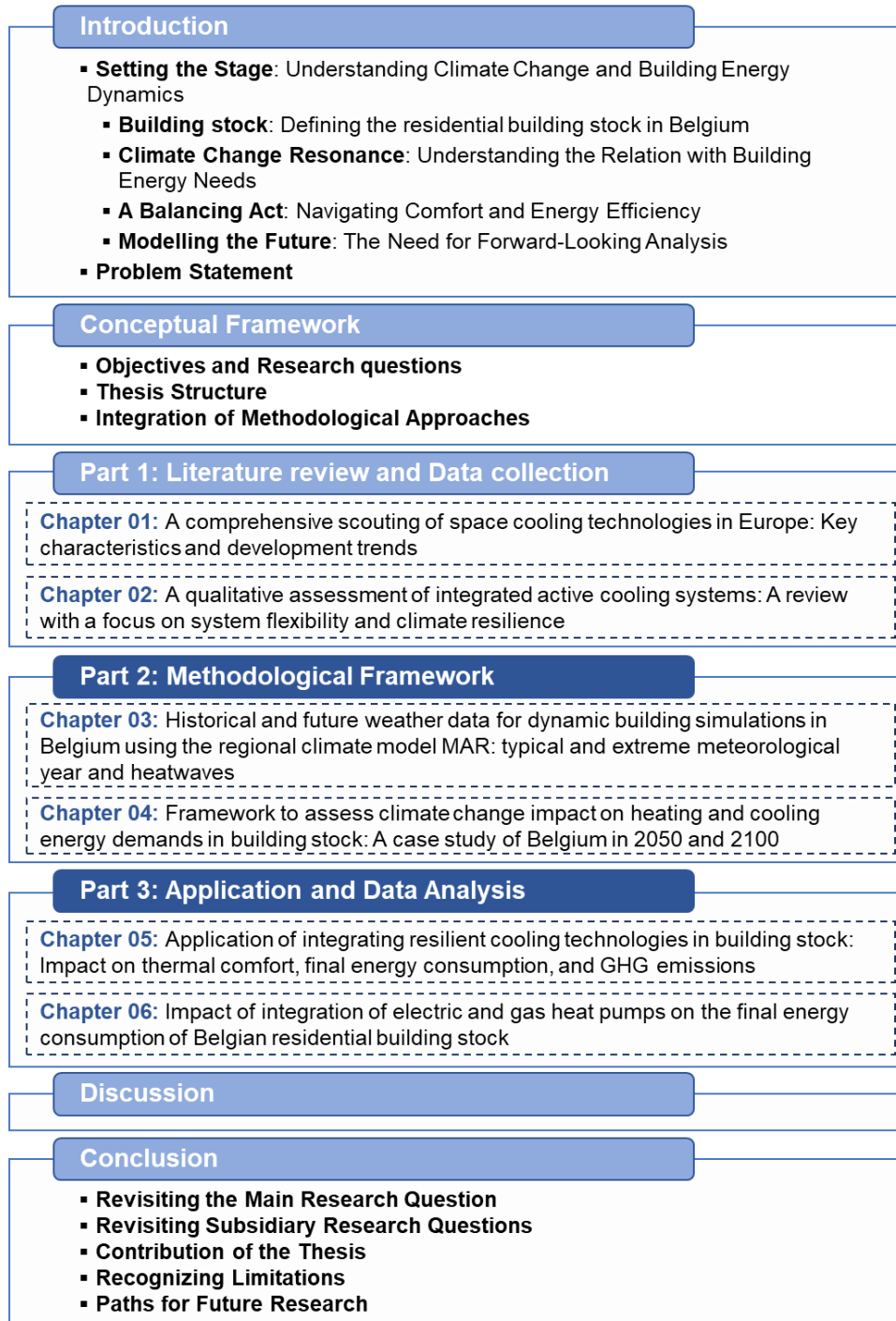

Figure 2.1. Thesis structure

2.3. Integration of methodological approaches

This section serves as an overview of the methodological approach employed in each chapter, offering insight into how the various chapters are presented and interconnected. While detailed methodologies are extensively presented in each individual chapter.

Chapter 01 undertakes a comprehensive exploration of space cooling technologies in Europe through an extensive and meticulously crafted methodology. The foundation of this study rests on a thorough and rigorous analysis of multiple sources, with a deliberate focus on utilizing the most recent and credible references. By adopting this approach, the research ensures the reliability and accuracy of the information, thus providing an up-to-date and comprehensive taxonomy of alternative space cooling technologies. The central goal is to categorize 32 such technologies, employing a carefully designed set of eight fundamental scouting parameters. These parameters form the basis of the taxonomy and encompass crucial aspects of space cooling technologies. They include:

- 1) Physical form of energy: this parameter categorizes technologies based on the type of energy they utilize, such as electrical, mechanical, chemical, magnetic, acoustic, thermal, potential, and "natural" energy sources.
- 2) Working principle: It defines the fundamental principles and mechanisms on which the cooling technologies operate.
- 3) Refrigerant or heat transfer medium: this parameter characterizes the medium used to transfer heat within the cooling systems, whether solid, gaseous, liquid, or multiphase.
- 4) Phase of the working fluid: it specifies the state of the working fluid, classifying it as single-phase, two-phase, no-phase change, subcritical, or supercritical.
- 5) Specific physical process/device: here, the study examines the specific devices and processes employed to extract heat and achieve the desired cooling effect.
- 6) Type of space Cooling technology: this parameter distinguishes between active, passive, or a combination of both cooling technologies.
- 7) Fuel type: it focuses on the type of fuel used to power the cooling systems, including consideration of renewable energy sources.
- 8) Technology Readiness Level (TRL): the TRL parameter evaluates the maturity and readiness of each technology, employing a scale from 1 to 9, with 9 representing the most advanced and market-ready technologies.

This multi-faceted taxonomy provides a holistic view of the alternative space cooling landscape, allowing for a comprehensive assessment of these technologies. The research underscores the significance of these cooling technologies in addressing the escalating demand for space cooling in Europe, an issue that has far-reaching implications for energy efficiency and environmental sustainability.

Currently, a substantial portion of cooling demand in Europe is met by conventional vapor compression systems (99%), with a smaller fraction covered by thermally-driven heat pumps. While alternative space cooling technologies show promise in terms of energy efficiency, they are yet to outperform vapor compression systems regarding overall efficiency and cost-effectiveness, particularly in the short and medium terms. Among the alternative technologies assessed, membrane heat pumps, thermionic systems, thermotunnel systems, and evaporative liquid desiccant systems exhibit notable cost-competitiveness and energy efficiency in specific space cooling applications. In this study, the assessed cooling technologies need to achieve TRL between 5 and 9 to be considered commercially viable. Specifically, a TRL level of 8 to 9 is highly desirable for technologies that are already in the market or nearing market readiness.

In conclusion, this chapter's methodology provides a robust framework for comprehensively understanding and categorizing space cooling technologies. It underscores the vital role these technologies play in addressing the increasing demand for cooling, while also emphasizing the need for ongoing research and development to enhance their efficiency, reduce costs, and improve market competitiveness.

Chapter 02 presents a qualitative assessment of integrated active cooling systems, focusing on system flexibility and climate resilience. The methodology for this assessment involved the classification of cooling systems into two main categories: electricity-driven and thermal energy-driven systems. The assessment criteria used to evaluate these systems encompassed five key parameters: energy performance, flexibility to energy sources and integration with secondary systems, climate resilience in the face of heatwaves and power outages, building typology, and TRL. The assessment focus unfolds in two vital dimensions:

Flexibility of the system:

- 1) **Energy source flexibility:** One of the primary criteria for assessing cooling systems is their ability to adapt to various energy sources. The study investigates the integration of different energy sources into these systems, promoting hybrid solutions that can meet a building's energy demands efficiently. This flexibility extends to incorporating renewable energy sources, such as solar photovoltaic (PV) systems. This aspect is crucial in reducing carbon emissions and enhancing sustainability.
- 2) **Integration with secondary systems:** Another dimension of flexibility considers the integration between the primary air conditioning system components and secondary systems, such as fan coil units (FCUs) and radiant floor systems. This integration broadens the range of operating conditions and temperatures for the system, potentially enhancing its performance and overall flexibility. However, it's important to note that integration with secondary systems can also increase the complexity of the system.

Climate resilience:

- 3) Heatwaves: With the increasing frequency of heatwaves, the paper evaluates the resilience of cooling systems to extreme temperature events. The study focuses on how well these systems can maintain indoor thermal comfort during heatwaves. Systems with high climate resilience are those that can efficiently operate in high-temperature conditions, ensuring that occupants remain comfortable despite soaring outdoor temperatures.
- 4) Power outages: Power outages can disrupt the operation of cooling systems, especially electricity-driven ones. The methodology assesses the resilience of different cooling systems to power outages and their ability to adapt and continue functioning effectively after such events. It's noted that systems with low electrical input tend to be more resilient in this regard. This comprehensive evaluation underscores the significance of flexible and resilient cooling systems in addressing escalating energy demands and advancing sustainability amid evolving environmental challenges.

Each cooling system was assessed for its efficiency, flexibility to different energy sources, integration with secondary systems, and ability to withstand extreme climate events. The study compared over 20 cooling systems, providing insights into their strengths, weaknesses, and readiness for the market. The methodology's strength lies in its comprehensive consideration of various assessment criteria and its wide-ranging analysis of cooling technologies, encompassing diverse building types and capacities. However, it acknowledges limitations in terms of data availability and varying boundary conditions for different systems. This chapter offers valuable insights and recommendations for the future direction of research in the field of cooling technologies, aiming to improve their resilience, efficiency, and environmental impact.

Chapter 03 outlines the methodology employed to generate historical and future weather data for dynamic building simulations in Belgium, with a focus on typical and extreme meteorological years and heatwaves. The regional climate model used in this research is the Modèle Atmosphérique Régional (MAR), specifically version 3.11.4. This model plays a critical role in downscaling global climate data to finer spatial and temporal resolutions, making it particularly relevant for building design, energy management, and climate resilience studies.

The study initially forces the MAR model with climate data from ERA5 reanalysis, which provides a representation of the closest climate to current reality, ensuring that the simulated data closely align with observed conditions. Additionally, the MAR model is further forced by three Earth system models (ESMs) from the Sixth Coupled Model Intercomparison Project (CMIP6) database: BCC-CSM2-MR, MPI-ESM.1.2, and MIROC6. These ESMs represent different climate scenarios, including a historical period (1980-2014) and a future period (2015-2100) based on different Shared Socio-economic Pathways (SSPs), such as SSP5-8.5, SSP3-7.0, and SSP2-4.5. The data

generated by the MAR model is at a high resolution of 5 km and is applicable to an integration domain centered over Belgium. Furthermore, the chapter selects 12 representative cities in Belgium to capture the spatial variability of climate conditions across the country. This diverse selection of cities accounts for the influence of various local factors on climate, such as the thermal inertia of the sea in coastal cities.

In terms of ESM selection, the study follows specific criteria to choose representative models for the western European region. It emphasizes ESMs that closely match atmospheric circulation patterns over western Europe, comparing them with ERA5 data from 1980 to 2014 to ensure minimal bias. The three selected ESMs include BCC-CSM2-MR, MPI-ESM.1.2, and MIROC6. To project future scenarios, the study employs the SSPs, representing different greenhouse gas emission scenarios. The main scenarios considered are SSP5-8.5 (very high GHGs), SSP3-7.0 (high GHGs), and SSP2-4.5 (intermediate GHGs), which influence the temperature increase expected for 2100. The chapter also addresses the generation of Typical Meteorological Year (TMY) and eXtreme Meteorological Year (XMY) datasets. TMYs and XMYs are valuable for modeling renewable energy systems and building energy management. These datasets are constructed by selecting typical or extreme months based on temperature and incoming solar radiation using the ISO15927-4 methodology.

The definition and generation of heatwave events are also detailed in this chapter. Heatwaves are classified based on retrospective and prospective definitions, but the study introduces a statistical definition to address regional variations and different ESMs' biases. Heatwaves are identified by specific temperature thresholds and can be characterized by their duration, maximum temperature, and intensity. Hourly weather data for different types of heatwaves is included in the generated datasets. Overall, this methodology ensures that the data produced is representative of both historical and future climate conditions, providing valuable resources for various applications related to building design, energy management, and climate resilience in Belgium.

Chapter 04 employs a comprehensive methodology to investigate the impact of climate change on heating and cooling energy demands in the Belgian building stock, projecting outcomes for the years 2050 and 2100. In the case of this study, a bottom-up methodology is employed to characterize the residential building stock in Belgium. This methodology comprises several key steps:

- 1) **Dynamic multi-zone model:** The chapter utilizes a dynamic multi-zone model to calculate heating and cooling energy demands for different building types and construction periods. This approach captures the intricacies of various building elements and their energy performance. Within this dynamic multi-zone model, the simplified building model for individual zones is based on the hourly time step method outlined in ISO 13790:2007. This method utilizes a thermal-electrical analogy and represents the building as a network of 5 resistances (R) and 1 capacity (C). This hourly time-step approach provides flexibility and accuracy while being computationally

manageable. The multi-zone approach considers five zones within buildings, each with individual heating and cooling loads, and calculates the total energy demand as the sum of these zones. The methodology also includes internal gains from occupancy, lighting, and appliances and accounts for ventilation through building infiltrations, considering factors like airtightness, site location, and wind speed to estimate the impact on heating and cooling demands.

- 2) Tree structure model: A tree structure model representing the Belgian residential building stock typology is developed. This tree structure serves as a crucial tool for evaluating the impact of different HVAC technology penetration scenarios on energy consumption and building stock characteristics.
- 3) Energy load profiles: Energy load profiles are created and calibrated to the Belgian context using stochastic probability curves. This step refines the understanding of energy consumption patterns specific to the Belgian building stock.
- 4) Building stock evolution: The study considers the evolution of the building stock until 2050, accounting for new developments, renovations, and changes in energy technologies and sources. This provides a forward-looking perspective on how the building stock may evolve over time.

Building stock structure: The tree structure model representing the residential building stock in Belgium is a foundational element of the study. It categorizes buildings based on several parameters:

- 1) Building type: Buildings are classified as freestanding, semi-detached, terraced, or apartments.
- 2) Year of construction: Buildings are categorized into construction periods, including pre-1945, 1946-1970, 1971-1990, 1991-2007, and 2008-2012.
- 3) Insulation level: This parameter describes the level of insulation in building components, including walls, windows, roofs, and floors.
- 4) Space heating energy vectors: These indicators represent the energy sources used for space heating, such as natural gas, electricity, and others.
- 5) Heating production system: This parameter differentiates between centralized and decentralized heating systems.
- 6) DHW (Domestic Hot Water) energy vectors: These indicate the energy sources used for domestic hot water, including fuel, natural gas, electricity, and others.

Base scenario and Business-As-Usual scenario: The study introduces two key scenarios: the Base Scenario and the Business-As-Usual (BAU) Scenario. The Base Scenario characterizes the building stock without considering any demolition or renovation strategies, serving as a baseline assessment of the current building stock's energy performance. The BAU Scenario extends the analysis up to 2050, taking into account annual rates of demolition, construction, deep retrofit, and shallow retrofit. The BAU Scenario reflects the evolving nature of the building stock over time, considering how new constructions, demolitions,

and renovation strategies may impact energy demand. Two renovation strategies are employed in the BAU Scenario:

- 1) Deep renovation: This strategy involves extensive insulation measures across all building components, enhancing energy efficiency.
- 2) Shallow renovation: Focusing on roof and window insulation, this strategy targets areas with significant heat loss.

The chapter considers various scenarios with different rates of demolition, shallow renovation, and deep renovation to account for the uncertainty surrounding future renovation rates. Eight distinct renovation scenarios are formulated to account for different renovation rate possibilities. Each scenario represents a unique combination of renovation rates, reflecting varying levels of demolition, shallow renovation, and deep renovation.

The chapter ensures the accuracy of its building stock model through a thorough validation process. It relies on past research that showed the reliability of the method used to estimate heating and cooling energy demand. This method was compared to detailed simulations and real data, and the results matched well. To validate heating energy demand, historical gas consumption data from a large set of 2500 homes in Belgium, known as the Synthetic Load Profiles (SLPs), is used. The model's predictions closely align with these SLPs. It's important to note that the study also accounts for heating system efficiency and energy source variations. However, when it comes to cooling energy, there's limited data available for validation because not many buildings in Belgium use cooling systems due to the country's temperate climate.

Chapter 05 investigates the impact of resilient cooling strategies on thermal comfort, energy consumption, and GHG emissions in the building stock under changing climate scenarios. The research methodology is crucial in assessing the resilience of buildings to the intensifying heatwaves caused by global warming. The study utilized the MAR model, as explained in Chapter 03.

The chapter employed climate-sensitive approaches in selecting and sizing cooling systems based on the ISO 15927-2 standard. This standard ensures that the chosen HVAC systems are suitable for various weather scenarios, ultimately enhancing indoor thermal comfort. In doing so, it addressed the critical issue of the appropriateness of the sizing methods for cooling systems, especially in the face of extreme heatwaves. The chapter assessed thermal comfort using the indoor overheating degree (IOhD) indicator across different building types and weather scenarios. Three scenarios were explored: Scenario 1 (Mechanical Ventilation), Scenario 2 (Mechanical Ventilation and Natural Ventilation), and Scenario 3 (Mechanical Ventilation, Natural Ventilation, and Split System). These scenarios allow for a comprehensive evaluation of thermal comfort under different cooling strategies.

Furthermore, the chapter investigated the impact of these cooling scenarios on Indoor Operative Temperature (IOpT) during heatwaves. It focused on variations in IOpT between insulated and non-insulated buildings, highlighting the challenges and opportunities related to maintaining thermal comfort during

extreme heatwaves. Additionally, the chapter assessed the implications of these cooling strategies on energy consumption, with a particular emphasis on cooling and ventilation energy demands. Moreover, the chapter delved into the impact of cooling strategies on greenhouse gas emissions in the building sector. It quantified the escalating greenhouse gas emissions associated with cooling systems and identified the critical need to address this issue through passive and sustainable cooling strategies.

Chapter 06 focuses on the impact of integrating electric and gas-driven heat pump technologies on the final energy consumption of the Belgian residential building stock. This research aims to understand how the adoption of different heat pump systems for heating and domestic hot water (DHW) production affects the overall energy consumption of residential buildings in Belgium. The study considers base and predictive scenarios, evaluates the penetration rates of two types of heat pumps (electricity-driven and gas-driven), and assesses the impact of the building's thermal envelope on the adoption of these systems.

The electricity-driven heat pump scenario primarily focuses on air-source heat pumps powered by electricity. To model these heat pumps, polynomial laws are used to fit their performance maps, which are provided by various manufacturers. Three different types of electricity-driven heat pumps are selected based on the overall U-value of the building, ranging from low-temperature heat pumps to high-temperature heat pumps. This scenario uses a stationary balance approach to determine whether a heat pump can be installed in a given building. It considers the building's space heating and DHW loads, with a maximum rating power of the heat pump at -10°C .

The gas-driven heat pump scenario introduces gas-driven absorption heat pumps (GAHP) for space heating and DHW production. These GAHPs are based on the Water-Ammonia absorption cycle and use outdoor air as the low-temperature heat source and natural gas (NG) combustion as the high-temperature heat source. The performance of the GAHP is based on laboratory tests, and a model compatible with buildings is developed.

The chapter assesses the two scenarios to calculate the maximum penetration rates of these heat pump technologies and their impact on the final energy consumption and GHG emissions. The study also investigates how changes in the minimum indoor temperature used in the sizing criteria for heat pumps can impact their maximum penetration rates.

3.Scholarly publications

Chapter 01: A comprehensive scouting of space cooling technologies in Europe: Key characteristics and development trends.

Journal Paper (Appendix A)

Abstract: This paper presents a comprehensive taxonomy and assessment of existing and emerging space cooling technologies in Europe. The study aims to categorize 32 alternative space cooling technologies based on eight scouting parameters (physical energy form, basic working/operating principle, refrigerant or heat transfer medium, phase of the working fluid, specific physical process/device, type of space cooling technology, fuel type and technology readiness level) and evaluate their key characteristics and development trends. The increasing demand for space cooling in Europe necessitates a thorough understanding of these technologies and their potential for energy efficiency. The majority of space cooling demand in Europe is currently met by conventional vapour compression systems, while a small portion is covered by thermally-driven heat pumps. The study reveals that several alternative space cooling technologies show promise for energy-efficient cooling but are not yet competitive with vapour compression systems in terms of efficiency and cost in the short-term and medium-term. However, technologies such as membrane heat pumps, thermionic systems, thermotunnel systems, and evaporative liquid desiccant systems demonstrate cost-competitiveness and energy efficiency in specific applications. The findings highlight the need for further research and development to improve the efficiency, costs, and market competitiveness of alternative space cooling technologies. The study also emphasizes the importance of policy support and the urgency to reduce greenhouse gas emissions, which can drive the adoption and advancement of sustainable cooling solutions.

Role of Ph.D. student:

First author

Journal:

Renewable and Sustainable Energy Reviews

Journal metrics (Scopus):

Scopus coverage years: from 1997 to Present, **Subject area:** Energy: Renewable Energy, Sustainability and the Environment (#9/235 – Q1), **Publisher:** Elsevier, **ISSN:** 1364-0321, **CiteScore 2022:** 26.3, **SJR 2022:** 3.232, **SNIP 2022:** 3.631.

Reference:

Elnagar, E., Pezzutto, S., Duplessis, B., Fontenaille, T., & Lemort, V. (2023). A comprehensive scouting of space cooling technologies in Europe: Key characteristics and development trends. *Renewable and Sustainable Energy Reviews*, 186, 113636. <https://doi.org/10.1016/j.rser.2023.113636> & <https://hdl.handle.net/2268/306088>

Chapter 02: *A qualitative assessment of integrated active cooling systems: A review with a focus on system flexibility and climate resilience.*

Journal Paper (Appendix B)

Abstract: Space cooling now has the fastest-growing energy end-use in buildings, with an almost tripled energy demand compared to 1990. This paper provides a state-of-the-art review of different integrated active cooling systems for buildings. The cooling systems are classified based on the energy source, with attention to the performance of the systems under multi-criteria assessment. The assessment criteria are described in five main parameters for energy performance, flexibility to energy sources and integration with secondary systems, climate resilience to heatwaves and power outages, as well as building typology, and technology readiness level. The qualitative assessment shows that electricity-driven systems are widely available in the market and have several applications integrated with PV systems. Therefore, they are more resilient to heatwaves. Only chillers are highly integrated with secondary systems among electricity-driven systems. The study also found that only air-cooled and water-cooled chillers can operate in passive cooling mode. It is found that thermal energy-driven systems are more flexible to be driven by different energy sources, in addition to being more resistant to power outages due to their low electrical input. Finally, some recommendations for further research and practice are given based on the study's strengths and limitations.

Role of Ph.D. student:

First author

Journal:

Renewable and Sustainable Energy Reviews

Journal metrics (Scopus):

Scopus coverage years: from 1997 to Present, **Subject area:** Energy: Renewable Energy, Sustainability and the Environment (#9/235 – Q1), **Publisher:** Elsevier, **ISSN:** 1364-0321, **CiteScore 2022:** 26.3, **SJR 2022:** 3.232, **SNIP 2022:** 3.631.

Reference:

Elnagar, E., Zeoli, A., Rahif, R., Attia, S., & Lemort, V. (2023). A qualitative assessment of integrated active cooling systems: A review with a focus on system flexibility and climate resilience. *Renewable and Sustainable Energy Reviews*, 175, 113179.

<https://doi.org/10.1016/j.rser.2023.113179> & <https://hdl.handle.net/2268/299261>

Chapter 03: *Historical and future weather data for dynamic building simulations in Belgium using the regional climate model MAR: typical and extreme meteorological year and heatwaves.*

Journal Paper (Appendix C)

Abstract: Increasing temperatures due to global warming will influence building, heating, and cooling practices. Therefore, this data set aims to provide formatted and adapted meteorological data for specific users who work in building design, architecture, building energy management systems, modeling renewable energy conversion systems, or others interested in this kind of projected weather data. These meteorological data are produced from the regional climate model MAR (Modèle Atmosphérique Régional in French) simulations. This regional model, adapted and validated over Belgium, is forced firstly by the ERA5 reanalysis, which represents the closest climate to reality, and secondly, by three Earth system models (ESMs) from the Sixth Coupled Model Intercomparison Project database, namely, BCC-CSM2-MR, MPI-ESM.1.2, and MIROC6. The main advantage of using the MAR model is that the generated weather data have a high resolution (hourly data and 5 km) and are spatially and temporally homogeneous. The generated weather data follows two protocols. On the one hand, the Typical Meteorological Year (TMY) and eXtreme Meteorological Year (XMY) files are generated largely inspired by the method proposed by the standard ISO 15927-4, allowing the reconstruction of typical and extreme years while keeping a plausible variability of the meteorological data. On the other hand, the heatwave event (HWE) meteorological data are generated according to a method used to detect the heatwave events and to classify them according to three criteria of the heatwave (the most intense, the longest duration, and the highest temperature).

Role of Ph.D. student:

Co-author (**Contribution:** Conceptualization, Methodology, Investigation, Validation, Writing – Original Draft, Review, & Editing)

Journal:

Earth System Science Data

Journal metrics (Scopus):

Scopus coverage years: from 2009 to Present, **Subject area:** Earth and Planetary Sciences: General Earth and Planetary Sciences (#5/192 – Q1), **Publisher:** Copernicus. **ISSN:** 1866-3508, **E-ISSN:** 1866-3516, **CiteScore 2022:** 14.9, **SJR 2022:** 4.240, **SNIP 2021:**3.321.

Reference:

Doutreloup, S., Fettweis, X., Rahif, R., Elnagar, E., Pourkiaei, M. S., Amaripadath, D., and Attia, S.: Historical and future weather data for dynamic building simulations in Belgium using the regional climate model MAR: typical and extreme meteorological year and heatwaves, *Earth Syst. Sci. Data*, 14, 3039–3051.

<https://doi.org/10.5194/essd-14-3039-2022> & <https://hdl.handle.net/2268/293076>

Chapter 04: Framework to assess climate change impact on heating and cooling energy demands in building stock: A case study of Belgium in 2050 and 2100.

Journal Paper (Appendix D)

Abstract: Climate change has a broad impact on different aspects of energy use in buildings. This study explores potential changes in future heating and cooling energy demands. Increasing comfort expectations resulting from events like the extraordinary summer heatwaves in Europe are accelerating this trend to develop future scenarios for a better understanding of the relationship between future climate changes and the cooling need. This study used future weather data to estimate the heating and cooling energy demands in the Belgian building stock by 2050 and 2100 under base and business-as-usual scenarios using a dynamic building simulation model. The study showed that heating energy demand in the base scenario is expected to decrease by 8% to 13% in the 2050s and 13% to 22% in the 2090s compared to the 2010s. Additionally, the cooling energy demand is expected to increase by 39% to 65% in the 2050s and by 61% to 123% in the 2090s compared to the 2010s. Retrofit strategies applied to different building types contribute to lower the increase in cooling energy demand in the business-as-usual scenario compared to the base scenario. The cooling energy demand for an average building in the business-as-usual scenario is expected to increase with a range of 25% to 71% in the 2050s compared to 45% to 92% in the base scenario and 77% to 154% in the 2090s compared to 72% to 198% in the base scenario compared to the 2010s. The findings of the study provide insights to mitigate the impacts of climate change on heating and cooling energy demands.

Role of Ph.D. student:

First author

Journal:

Energy and Buildings

Journal metrics (Scopus):

Scopus coverage years: 1970, from 1977 to 1979, from 1981 to Present, **Subject area:** Engineering: Mechanical Engineering (#23/631 – Q1), Engineering: Civil and Structural Engineering (#15/350 – Q1), Engineering: Building and Construction (#9/200 – Q1), and Engineering: Electrical and Electronic Engineering (#49/738– Q1), **Publisher:** Elsevier, **ISSN:** 0378-7788, **CiteScore 2022:** 11.8, **SJR 2022:** 1.608, **SNIP 2022:** 1.922.

Reference:

Elnagar, E., Gendebien, S., Georges, E., Berardi, U., Doutreloup, S., & Lemort, V. (2023). Framework to assess climate change impact on heating and cooling energy demands in building stock: A case study of Belgium in 2050 and 2100. *Energy and Buildings*, 298, 113547. <https://doi.org/10.1016/j.enbuild.2023.113547> & <https://hdl.handle.net/2268/307247>

Chapter 05: *Application of integrating resilient cooling technologies in building stock: Impact on thermal comfort, final energy consumption, and GHG emissions.*

Journal Paper (Appendix E)

Abstract: Buildings in the EU contribute significantly to energy consumption and greenhouse gas emissions, with HVAC systems being major contributors. This paper assesses the impact of resilience of various cooling strategies on thermal comfort, energy consumption, and GHG emissions in the residential building stock in Belgium. This study uses an innovative approach for sizing and designing cooling systems, considering the impact of climate change on future weather conditions and extreme heatwaves. The findings reveal alarming temperature increases, with potential rises of up to 4.1°C from the 2010s to the 2090s, particularly in the high-emission SSP5-8.5 scenario. The study investigates three cooling strategies: scenario 1 (mechanical ventilation), scenario 2 (mechanical ventilation and natural ventilation), and scenario 3 (mechanical ventilation, natural ventilation, and split System). In scenario 1, there is a notable increase in IOhD, reaching up to 586% in the 2090s for semi-detached buildings, while scenario 2 consistently reduces IOhD, reaching only 0.2 by the 2090s. Scenario 3 achieves near-zero IOhD by the 2050s and 2090s. Notably, the "Heatwave [2081-2100]" exhibits unprecedented daytime temperatures, peaking at 46.0°C. During the 2054 heatwave, insulated buildings maintained IOpT below 40°C, whereas non-insulated buildings reached 44.3°C, indicating challenges in meeting thermal comfort standards. Furthermore, cooling energy consumption increased by 106% to 141% in the 2050s and surge by 174% to 280% in the 2090s compared to the 2010s, along with significant GHG emissions growth in the future scenarios, particularly in SSP5-8.5.

Role of Ph.D. student:

First author

Journal:

Building and Environment (**In Review**)

Journal metrics (Scopus):

Scopus coverage years: from 1976 to Present, **Subject area:** Social Sciences: Geography, Planning and Development (#21/779 – Q1), Engineering: Civil and Structural Engineering (#17/350 – Q1), Engineering: Building and Construction (#11/211 – Q1), and Engineering: Environmental Science: Environmental Engineering (#15/187 – Q1), **Publisher:** Elsevier. **ISSN:** 0360-1323, **CiteScore 2022:** 11.3, **SJR 2022:** 1.584, **SNIP 2022:** 2.229.

Reference:

Elnagar, E., Arteconi, A., Heiselberg, P., & Lemort, V. (2023). *Application of integrating resilient cooling technologies in building stock: Impact on thermal comfort, final energy consumption and GHG emissions.* *Building and Environment (In Review)*

Chapter 06: *Impact of integration of electric and gas heat pumps on the final energy consumption of Belgian residential building stock.*

Journal Paper (Appendix F)

Abstract: The paper investigates the evolution of electricity-driven and gas-driven heat pumps technologies used for heating in the residential building stock in Belgium in the market. A base and predictive scenarios are considered. The base scenario includes the current share of the existing heat pumps in the Belgian market while the predictive scenario considers the increased share of the studied heating systems based on the evolution of the buildings envelope over the period 2020-2050. Two different types of heat pumps are considered, one driven by electricity which performance indicators are based on the literature, while experimental data is used for natural gas-driven heat pumps. The latter is modeled in an empirical way based on the system operating conditions and weather data. This paper presents the entire housing stock in Belgium which is divided in 752 cases. A tree structure model defining Belgian housing typology was created, characterizing Belgian residential building stock in terms of various parameters like building age, scale, level of insulation, and energy vectors. A weighting factor to represent their occurrence in the existing Belgian building stock is associated with each building type. To study the impact on the load profile and the final energy consumption, the penetration of the selected heat pumps is calculated through the base and predictive scenarios. The penetration rates obtained of 67.6% and 42.7% for electricity and gas-driven HPs respectively, will allow to carry out some production planning for energy suppliers, manufacturers, and policymakers. Finally, the evolution of the sizing criteria in the future will have an impact on the penetration rates of the studied systems and must not be neglected.

Role of Ph.D. student:

First author

Conference:

CLIMA 2022: REHVA 14th HVAC World Congress – Rotterdam, The Netherlands. CLIMA 2022 is organized by the Dutch Society for Building Services (TVVL) in collaboration with both Delft University of Technology and Eindhoven University of Technology.

Reference:

Elnagar, E., Davila, C., & Lemort, V. (2022). Impact of integration of electric and gas heat pumps on the final energy consumption of Belgian residential building stock.

CLIMA 2022 conference.

<https://doi.org/10.34641/clima.2022.102> & <https://hdl.handle.net/2268/290752>

4. Discussion

The findings of each chapter (Chapter 01 to Chapter 06) are elaborated upon within their respective sections based on the scientific publications. This section delves deeper into the interconnections between each chapter as shown in Figure 4.1, highlighting how the inputs and outputs from one chapter are linked and utilized in the others.

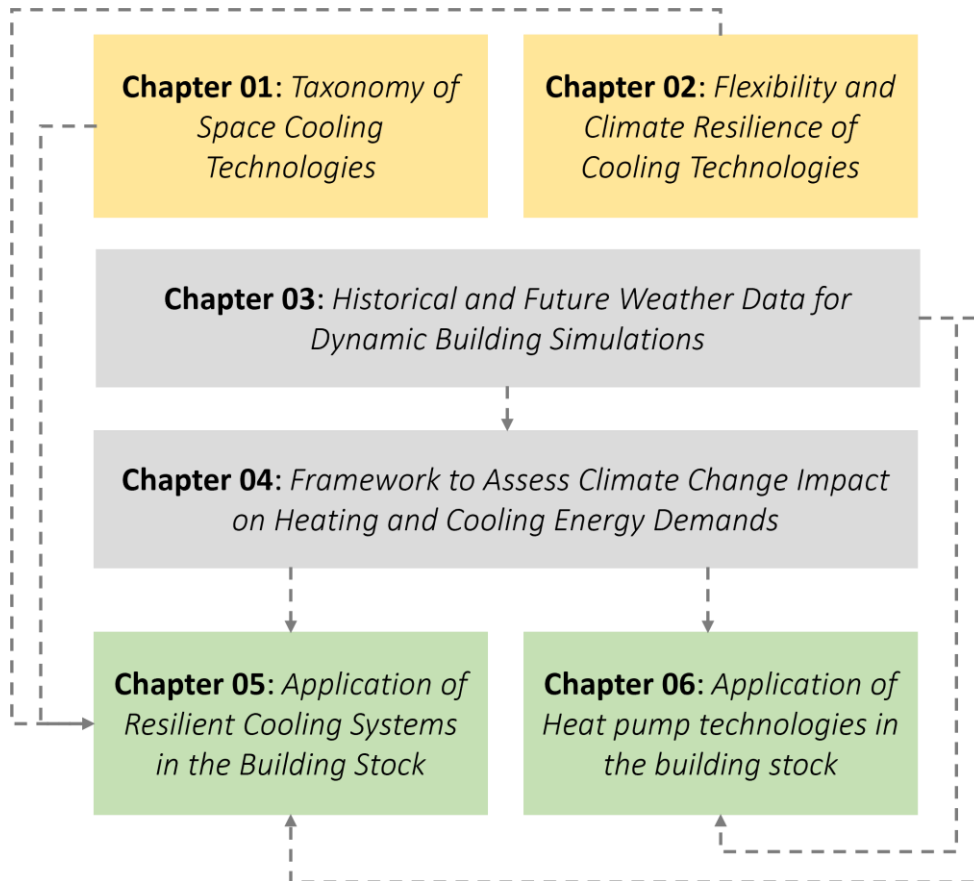

Figure 4.1. Interconnections between the different chapters

The Ph.D. thesis aims to model the influence of climate change on heating, cooling energy demands, thermal comfort, and greenhouse gas (GHG) emissions for Belgium's building stock. To achieve this objective, several key chapters have been outlined and connected to address various aspects of the research seamlessly. The core modeling and application phases of this thesis are carried out in chapter 05 and chapter 06, each with distinct objectives:

Chapter 05 is dedicated to the application of integrating resilient cooling technologies within the building stock. Its primary objective is to assess the impact of these technologies on key factors, including thermal comfort, final energy consumption, and GHG emissions. By doing so, it aims to provide insights into how resilient cooling technologies can contribute to sustainable building practices, especially in the context of climate change. Chapter 06 focuses on the shifts towards the integration of electric and gas heat pumps in Belgian residential building stock. The primary objective is to evaluate the potential of these heat pump systems in reducing energy consumption. By

assessing their performance and efficiency, this chapter aims to provide valuable information for enhancing the energy efficiency of residential buildings in Belgium. These two chapters together form the practical application part of the thesis, where modeling and assessment are applied to real-world scenarios, addressing specific objectives related to cooling technologies and heat pump integration in the context of climate change and building energy efficiency.

Before delving into the modeling and application phase, it was essential to conduct a thorough literature review and gather relevant data. The focus of this research tilted significantly toward cooling systems, primarily due to the heightened relevance of summer heatwaves in the context of climate change. Additionally, a substantial portion of the thesis addresses the integration of electricity-driven and gas-driven heat pumps as heating technologies. Since previous studies comprehensively covered the heating aspect, the literature review and data collection predominantly centered around cooling systems.

Given the primary emphasis on cooling systems and the identified knowledge gap regarding space cooling technologies and their development trends, chapter 01 offers an expansive survey of space cooling technologies and their development trends within the European context. Furthermore, chapter 02 conducts a qualitative assessment of integrated active cooling systems, with a specific focus on evaluating their flexibility and resilience to heatwaves and power outages. These chapters provide valuable insights into the current state of cooling technologies and their potential for adaptation in the face of changing climatic conditions. The findings of chapters 01 and chapter 02 were the groundwork for the subsequent modeling and application phases in chapter 05, which specifically addresses cooling systems. This seamless integration of research phases enhances our understanding of cooling technologies and their adaptability, creating a comprehensive approach to addressing the challenges posed by climate change in the building sector.

In order to effectively model the cooling and heating systems in chapter 05 and chapter 06, it was imperative to establish a robust framework and acquire essential data to underpin the application phase. Thus, chapter 03 of this thesis serves as a pivotal component by providing historical and future weather data crucial for dynamic building simulations within the Belgian context. Leveraging the regional climate model MAR, this chapter offers insights into typical and extreme meteorological conditions, including heatwaves. This weather data is indispensable for creating accurate and reliable simulations of building responses to varying climatic scenarios.

However, the core part of this Ph.D. thesis lies in chapter 04, which represents a critical milestone. This chapter presents a comprehensive framework for assessing the impact of climate change on heating and cooling energy demands within the building stock. It does not only establish the methodology for quantifying these energy demands but also introduces vital considerations for a building stock scale, aligning with the overarching objectives of this research. Additionally, Chapter 04 elucidates the modeling approaches adopted for the building stock, ensuring that the research addresses not only individual buildings but also the collective impact on a building stock scale. In essence, chapters 03 and 04 are foundational for the rest of the research. They provide the necessary data and framework for the modeling and application phases in chapter 05 and chapter 06.

- 1) Chapter 01 was conducted to address a significant knowledge gap in the field of space cooling technologies. The main problem identified was the growing demand for space cooling and its substantial impact on electricity consumption, particularly in residential buildings [37,78–80]. With the heating and cooling sector being a major contributor to primary energy consumption in the EU [81,82], understanding and improving cooling systems' efficiency was crucial. The chapter revealed that vapor compression (VC) air-conditioning systems dominated the market, accounting for 99% of space cooling technologies, while thermally-driven heat pumps (TDHPs) represented just 1% [83]. VC systems were widely adopted due to their efficiency and low operating costs but had environmental drawbacks, as they used refrigerants contributing to climate change [84]. Regulations focused on enhancing efficiency and reducing the impact on climate change, but alternative cooling technologies remained relatively unexplored [85,86]. The primary goal of Chapter 01 was to bridge this gap by conducting an extensive literature review and patent search to identify emerging and alternative space cooling technologies. The review highlighted the lack of research for alternative space cooling systems compared to VC systems [87–90].

Chapter 01 started with an extensive literature review, relying on a set of key studies as primary resources [91–96]. To create the space cooling taxonomy, eight key parameters were identified: (i) Physical energy form (ii) Basic working/operating principle (iii) Refrigerant or heat transfer medium (iv) Phase of the working fluid (v) Specific physical process/device (vi) Type of cooling technology (active, passive, or both) (vii) Fuel type (renewable or non-renewable) (viii) Technology Readiness Level (TRL). The taxonomy was developed by categorizing cooling technologies based on these parameters, resulting in a comprehensive classification of various cooling technologies according to their fundamental characteristics. The study then delved into technology scouting, investigating a total of 32 alternative space cooling technologies. It provided detailed descriptions of these technologies, including their major technical characteristics, costs, and development trends. In presenting the findings, chapter 01 unveiled the complete taxonomy of space cooling technologies. It also discussed conventional vapor compression (VC) systems, serving as a reference point for evaluating alternative technologies. Additionally, the chapter shed light on alternative space cooling technologies, highlighting both their potential and limitations.

- 2) Transitioning from the comprehensive taxonomy of space cooling technologies in chapter 01, it is evident that assessing cooling technologies for their flexibility and climate resilience, particularly in the face of heatwaves and power outages, becomes imperative as assessed in chapter 02. While passive cooling techniques and natural ventilation offer sustainable solutions, they may fall short in effectively countering the impacts of climate change. The necessity of active cooling systems (ACs) in hot climates for maintaining indoor thermal comfort remains undisputed, considering the predicted global surface temperature increase due to climate change [97]. Previous studies have explored various cooling technologies, with some focusing solely on the performance of vapor compression (VC) air-conditioning systems [84] and others examining thermal energy-driven

cooling systems [61]. However, a critical knowledge gap persists in comprehensively assessing and comparing different cooling systems, both electricity-driven and thermal energy-driven, based on a broad range of criteria, including flexibility, and climate resilience. While chapter 01 laid the foundation by presenting a taxonomy, chapter 02 delves deeper, conducting a qualitative assessment against a set of criteria. It evaluates cooling systems based on their physical principles, such as reversibility, recovery, and passivity, while also considering parameters like energy performance, flexibility, and climate resilience to heat waves and power outages. In addition to that, chapter 02 evaluated the integration of cooling technologies within buildings, extending beyond primary cooling systems. For electricity-driven systems, it explores ground coupling methods, PV panels as additional energy sources, mechanical ventilation systems, and radiant heating/cooling. For thermal energy-driven systems, it considers integration with renewable sources like thermal panels and biomass supply. This holistic assessment helps stakeholders choose and integrate cooling systems that align with secondary systems and renewable energy sources, enhancing building sustainability and resilience.

- 3) Chapter 03 of this thesis addresses a critical knowledge gap in climate research related to the impact of climate change on regional weather patterns, specifically focusing on Belgium. While global climate models provide a broad overview of future climate scenarios, regional-scale climate data are essential for localized assessments and practical applications. Furthermore, the chapter aims to contribute to a more detailed understanding of extreme weather events, particularly heatwaves, which have significant implications for various sectors, including human health, agriculture, building performance, and energy demand. To address these knowledge gaps, Chapter 03 employs the "Modèle Atmosphérique Régional" (MAR) model to downscale global climate data to a finer spatial and temporal resolution over Belgium and neighboring regions. This approach incorporates historical climate data (1980-2020) derived from the ERA-5 reanalysis model and future climate projections based on three Earth System Models (ESMs) from the Coupled Model Intercomparison Project Phase 6 (CMIP6) database.
 - This chapter generates high-resolution regional climate data (5 km spatial resolution) that provide a more detailed representation of climate patterns in Belgium compared to existing global climate models. This data serves as the cornerstone for subsequent chapters in the thesis.
 - Three ESMs, selected based on their ability to capture atmospheric circulation over western Europe and their representation of future climate scenarios, are used. These models help account for the range of potential climate outcomes in the future, including variations in temperature and precipitation.
 - The MAR simulations are rigorously evaluated against observed climate data to ensure their accuracy and reliability. The comparison of temperature and incident solar radiation between MAR simulations and ERA5 reanalysis data demonstrates the model's ability to replicate historical climate conditions.

- The chapter generates TMY and XMY datasets, commonly used by building designers and renewable energy system modelers. These datasets offer hourly weather data representative of typical and extreme years, essential for designing and optimizing energy systems.
- The chapter introduces a dynamic approach to defining heatwaves that considers local climate variations. This method overcomes the limitations of static definitions such as those based on fixed temperature thresholds, have limitations. For instance, some definitions stipulate a heatwave as a period of at least five consecutive days with a maximum temperature exceeding 25°C and a minimum of three days with temperatures exceeding 30°C, as per the Royal Meteorological Institute (RMI) of Belgium [98]. Another definition considers a heatwave as a period of at least three consecutive days with a minimum temperature of 18.2°C and a maximum temperature of 29.6°C or higher [99]. Chapter 03 allows for a more accurate assessment of heatwave events in different regions and under various climate scenarios.

Chapter 03 regional climate data and heatwave definitions serve as a foundation for subsequent chapters in the thesis, including Chapter 04, Chapter 05, and Chapter 06. The research in these chapters relies on the fine-resolution climate data and heatwave characterizations presented here, enabling more precise assessments of climate change impacts on various sectors and systems, including buildings, energy demand, and thermal comfort.

- 4) Chapter 04 delves into the building stock modeling, emphasizing the top-down and bottom-up approaches [46,47]. The primary knowledge gap within this chapter pertains to the top-down approach and building stock modeling. The top-down approach, while valuable for exploring connections between energy and economic sectors, lacks granularity in assessing building-specific energy performance and potential improvements. Conversely, the bottom-up approach offers a detailed and disaggregated representation of building stock components but demands substantial actual data [51]. This chapter seeks to address this gap by adopting a bottom-up methodology. Furthermore, the hybrid approach introduced in this chapter combines elements of both the representative and typical approaches, offering a nuanced perspective on the building stock. This innovative hybrid approach presents an opportunity to balance the broad overview provided by the representative approach with the detailed insights offered by the typical approach. It overcomes the typical approach's limitation of investigating a single case for each building type by considering multiple U values for different buildings, dependent on insulation levels.

Another notable knowledge gap addressed in Chapter 04 revolves around the uncertainty of renovation rates, a crucial factor in shaping the future of the building stock. The uncertainty analysis conducted in this chapter is a pivotal aspect of its methodology. It assesses the impact of the uncertain range of renovation rates on heating and cooling energy demands through eight distinct renovation scenarios. These scenarios encompass a spectrum of possibilities, ranging from very pessimistic cases with a 0% renovation

rate to highly optimistic scenarios where the whole building stock undergo renovation at the maximum rate in shallow renovation and deep renovation.

In Chapter 04, several key sections directly address the knowledge gap in the research:

- **ISO 13790 methodology:** The study's reliance on the ISO 13790 methodology, with its simplified hourly time step approach, helps bridge the knowledge gap by providing a standardized and well-established framework for estimating heating and cooling energy needs. This methodology ensures that the analysis is based on widely accepted principles and calculations [100].
- **Extension to multiple zones:** The extension of the building energy model to multiple zones addresses the need for a more granular understanding of energy needs within different parts of buildings. This detailed analysis contributes to identifying areas where energy-saving measures can be most effective, which is essential for practical energy efficiency strategies [48,101,102].
- **Model validation:** The chapter focuses on model validation, particularly for heating energy demand, directly aligns with the knowledge gap related to the accuracy and reliability of building energy models. By comparing model predictions with synthetic load profiles (SLPs) which are historical data of 2500 buildings in Belgium, the research provides empirical evidence of the model's performance, enhancing confidence in its results and addressing concerns about model accuracy.

- 5) Chapter 05 addresses several critical knowledge gaps related to the implementation of climate-resilient cooling strategies in the context of changing climate scenarios and their impact on thermal comfort, energy consumption, and greenhouse gas (GHG) emissions in building stock.

Chapter 05 builds upon the comprehensive framework established in Chapter 04, which is based on ISO 13790 but extends it by incorporating additional scenarios into the building stock assessment. While the base scenario and Business-As-Usual (BAU) scenario were initially considered, this chapter introduces a novel dimension by integrating the cooling systems scenario. One of the HVAC scenarios, developed numerically in the context of the Ph.D. research, explores the impact of resilient cooling within the building stock, further enhancing the framework's capacity to address the challenges posed by climate change and extreme heatwaves.

Key knowledge gaps addressed in chapter 05:

- **Climate-sensitive sizing:** this chapter addresses the knowledge gap concerning the appropriateness of cooling system sizing methods under different climate scenarios. By adopting climate-sensitive sizing based on ISO 15927-2 standards, it contributes to ensuring that cooling systems are adequately sized to maintain thermal comfort in a changing climate, addressing a critical gap in knowledge regarding HVAC system sizing.

- **Thermal comfort assessment:** The chapter uses the indoor overheating degree (IOhD) indicator to assess thermal comfort across various building types and weather scenarios.
 - **Variations in indoor operative temperature (IOpT):** The chapter explores variations in IOpT between insulated and non-insulated buildings during heatwaves. The analysis of heatwaves relies on data generated in Chapter 03, where three distinct heatwaves were examined, each occurring within different timeframes (2019, 2054 and 2083).
 - **Active cooling system and polynomial model:** Within this analysis, the chapter evaluates the performance of an active cooling system, specifically a reversible air-to-air heat pump, commonly referred to as a split system. To assess the system's performance under varying indoor and outdoor temperature conditions, a third-degree polynomial model is employed. This polynomial model, which has been validated through experimental work conducted previously, plays a crucial role in understanding the cooling system's behavior under different climate scenarios. The model considers the influence of indoor temperature as a variable in calculating electricity consumption and system capacity, allowing for a more accurate assessment of system performance.
 - **Integration of different cooling Technologies:** In this chapter, the research explores three distinct cooling strategies: Scenario 1 (Mechanical Ventilation), Scenario 2 (Mechanical Ventilation and Natural Ventilation), and Scenario 3 (Mechanical Ventilation, Natural Ventilation, and Split System). Notably, these strategies incorporate a combination of different cooling technologies, including both active cooling (the split system) and ventilative cooling (mechanical and natural ventilation). This strategic combination of cooling technologies aligns with the criteria for flexibility recommended in Chapter 02. By integrating various cooling methods, these scenarios offer adaptable solutions to address changing climate conditions.
- 6) Chapter 06 contributes significantly to closing knowledge gaps related to the integration of electricity-driven and gas-driven heat pumps in the building stock. In the context of the EU's energy consumption and greenhouse gas emissions reduction strategies, this chapter investigates the long-term energy use and CO₂ emissions impacts of different penetration scenarios for heat pump technologies in residential buildings, focusing on the Belgian context.

Building on the framework proposed in Chapter 04, which is based on ISO 13790, this chapter introduces two distinct HVAC scenarios, namely the electricity-driven heat pump scenario and the gas-driven heat pump scenario. These scenarios address the evolving landscape of heating technologies in residential buildings, encompassing both electricity-driven and gas-driven heat pumps. The electricity-driven heat pump scenario explores the maximum penetration rate of air-source heat pumps for space heating (SH) and domestic hot water (DHW) production. These heat pumps are modeled using polynomial laws, calibrated with experimental data, to accurately predict their performance. Conversely, the gas-driven heat pump scenario introduces a gas-driven absorption heat pump (GAHP) for SH and

DHW production, catering to residential applications. The chapter provides insights into the modeling and testing of the GAHP, emphasizing its benefits, including lower environmental impact, compared to traditional boilers.

5. Conclusion

The overarching objective of this Ph.D. thesis encompasses a multifaceted exploration of the effects of climate change on the Belgian residential building stock, with a specific emphasis on heating and cooling energy demands, final energy consumption, thermal comfort, and greenhouse gas (GHG) emissions. This research endeavors to address several key facets of climate change adaptation within the context of residential buildings. Firstly, it delves into the quantification of climate change impacts, encompassing both short-term fluctuations in the form of recurrent heatwaves and long-term trends associated with global warming. These assessments provide valuable insights into the evolving energy requirements and associated environmental implications faced by residential buildings.

In line with the thesis's overarching objective, a significant focal point revolves around cooling systems. While extensive research has been conducted on heating systems, the cooling aspect has often been underrepresented in existing literature. This gap underscores the need for a comprehensive review and quantitative assessment of cooling system integration in residential buildings. By doing so, the thesis aims to contribute to the body of knowledge concerning sustainable and energy-efficient cooling strategies, recognizing their increasing relevance in the face of rising temperatures.

Following the evaluation of cooling systems, the research extends its purview to investigate the efficacy of resilient cooling strategies, encompassing both active and passive approaches, within the residential building stock. These strategies are designed to facilitate adaptive responses to changing climate conditions, ensuring thermal comfort and energy efficiency in the face of evolving weather patterns. Moreover, the thesis adopts a rigorous approach to ensure the robustness of its findings. It incorporates uncertainty analysis to account for the inherent variability associated with climate projections and uncertain renovation strategies. Synthetic load profiles and projected weather files are employed to validate the research outcomes, enhancing the reliability of the results. Furthermore, this research venture explores the integration of electric and gas heat pumps within the residential building stock. By examining their impact on load profiles and final energy consumption, the study sheds light on the potential benefits and challenges associated with these technologies.

In summation, this Ph.D. thesis unfolds as a comprehensive exploration of climate change impacts on residential buildings, encompassing heating and cooling dynamics, energy consumption, thermal comfort, and GHG emissions. It fills a crucial research gap in the domain of cooling while also addressing wider climate adaptation concerns. The findings underscore the imperative of sustainable and energy-efficient cooling solutions in the face of changing climate conditions, offering valuable insights for future research, policy development, and practical applications in the field of building sustainability.

The conclusion section starts by revisiting the research questions (Section 5.1), reaffirming the study's primary objectives and scope. Subsequently, it delves into the contributions of the thesis (Section 5.2), emphasizing the main findings and contribution of the thesis. The section also acknowledges

limitations (Section 5.3), offering transparency and opportunities for improvement. Lastly, it outlines avenues for future research (Section 5.4), providing a forward-looking perspective. In summary, this conclusion section encapsulates the essence of the research, addressing research questions, highlighting contributions, recognizing limitations, and paving the way for future investigations.

5.1. Revisiting the research questions

The Ph.D. thesis consists of six chapters, with each chapter primarily focused on addressing one or more of the sub-research questions derived from the main research question and objective. These chapters present the research findings and culminate in the creation of six distinct scientific publications, each contributing to a more comprehensive understanding of the research area. Together, these publications provide valuable insights and solutions to the multifaceted challenges posed by climate change's impact on the Belgian building stock.

RQ1: *What are the key characteristics and future development trends of space cooling technologies in Europe, and how can these trends inform sustainable cooling practices in response to increasing demand for cooling solutions? (Chapter 01 & Chapter 05)*

In summary, this question has examined the key characteristics and future development trends of space cooling (SC) technologies in Europe, providing valuable insights into the landscape of alternative cooling solutions. The review assessed 32 alternative SC technologies based on eight critical parameters: energy input form, working principle, heat transfer medium, working fluid phase, specific process/device, technology type (active or passive), fuel type, and technology readiness level (TRL). These parameters allowed for a comprehensive categorization and evaluation of each technology.

The findings of this review reveal that while several alternative SC technologies show promise in terms of energy efficiency and environmental sustainability, they often face challenges when compared to conventional vapor compression (VC) systems, particularly in terms of cost and efficiency in the short to medium term. Notable among the promising technologies are membrane heat pumps, thermionic systems, thermotunnel systems, and evaporative liquid desiccant systems. These alternatives have demonstrated cost-competitiveness and energy efficiency in specific applications. Additionally, emerging technologies such as electrocaloric, electrochemical, Lorenz-Meutzner Cycle, turbo-compressor-condenser-expander heat pumps, elastocaloric, barocaloric, and magnetocaloric systems hold potential for surpassing the efficiency of traditional VC systems but are still in the developmental and testing phases, with unknown or unverified costs.

The review also identifies a trend toward reducing greenhouse gas emissions and dependence on non-renewable energy sources in SC technologies. This shift aligns with global efforts to address climate change and promote sustainability. Policy support emerges as a critical factor in facilitating the adoption of sustainable cooling solutions, with governments incentivizing energy-efficient and environmentally friendly SC technologies.

In conclusion, the methodology, which systematically evaluated and categorized various SC technologies based on crucial parameters, has provided comprehensive insights into the characteristics and potential of each technology. These findings will serve as a foundation for subsequent chapters, contributing to the understanding of sustainable cooling practices amid increasing demand for cooling solutions in the face of climate change.

RQ2: *How do integrated active cooling systems perform in terms of flexibility and climate resilience to heatwaves and power outages, and what implications does this have for their applications in buildings? (Chapter 02 & Chapter 05)*

The second research question aimed to understand how integrated active cooling systems perform in terms of flexibility and climate resilience to heatwaves and power outages, and what implications these findings have for their applications in buildings. The qualitative assessment conducted in this research classified active cooling systems into two main categories: electricity-driven and thermal energy-driven systems. These systems were evaluated based on five main assessment criteria:

- **Energy performance:** The efficiency of cooling systems, measured by parameters like EER, SEER, and COP, was examined.
- **Flexibility of the system:** This criterion considered the ability of cooling systems to be driven by various energy sources and their integration with secondary systems such as fan coil units and radiant floor systems.
- **Climate resilience to heatwaves:** The review assessed how well cooling systems could cope with recurring heatwaves, a phenomenon increasingly prevalent due to climate change. Resilience to heatwaves was influenced by factors like system integration with renewable energy sources and secondary systems.
- **Climate resilience to power outages:** Power outages can disrupt cooling systems' operation. The research evaluated the resilience of different cooling systems to power outages and their ability to adapt after such failures.
- **Other parameters:** Building type and Technology Readiness Level (TRL) were considered to understand the suitability of cooling systems for different types of buildings and their technological maturity.

The main findings from this assessment are as follows:

- **Electricity-driven systems:** These systems are generally more mature and efficient. They can be coupled with renewable energy sources like photovoltaic panels, offering flexibility and potential energy savings. Most electricity-driven systems can also operate in heating mode, providing year-round climate control.
- **Thermal energy-driven systems:** While these systems lack the technological maturity of electricity-driven counterparts, they offer flexibility in terms of energy sources. They are less dependent on electricity and can be driven by various thermal energy sources. Their efficiency may be influenced by outdoor temperatures.
- **Heatwaves resilience:** Some electricity-driven systems, such as split systems and chillers, exhibit high resilience to heatwaves, while others are less robust. Thermal energy-driven systems' resilience varies depending on system design and operating conditions.

- **Power outages resilience:** Electricity-driven systems are vulnerable to power outages due to their reliance on electricity. In contrast, thermal energy-driven systems, particularly sorption and desiccant systems, show higher resilience to power outages.
- **Building type and TRL:** Most cooling systems are suitable for various building types, with electricity-driven systems generally having a higher TRL compared to thermal energy-driven systems.

In the assessment of active cooling systems, factors such as reversibility, recovery at the condenser, and passive cooling mode were examined. Reversibility, the ability to operate in both cooling and heating modes, was found in most electricity-driven systems like split systems and chillers, offering versatile temperature control. Several systems demonstrated the capability to recover heat at the condenser, enhancing energy efficiency and resilience, including 3-pipe VRF systems, water-cooled chillers, absorption systems, adsorption systems, and ejector cooling systems. Air-cooled and water-cooled chillers stood out as the only systems capable of passive cooling, operating without active cooling mechanisms. These features provide valuable insights into system performance, energy efficiency, and resilience to power outages, contributing to a comprehensive assessment of active cooling systems.

In conclusion, the qualitative assessment of active cooling systems reveals that while electricity-driven systems are more mature and energy-efficient, thermal energy-driven systems offer flexibility in energy sources and enhanced resilience to power outages. The choice of cooling system depends on factors such as building type, climate conditions, and sustainability goals. The study revealed crucial insights into the integration of electricity-driven cooling systems with secondary systems and ventilation systems. These findings are invaluable for the overarching theme of the Ph.D. thesis, which focuses on the application of resilient cooling systems in various scenarios. These findings provide valuable insights for the selection and application of cooling systems in different contexts, considering both their energy performance and resilience to climate-related challenges.

RQ3: *How can MAR model-generated weather datasets inform strategies for adapting to climate change in Belgium across various global SSP Scenarios? (Chapter 03, Chapter 04, Chapter 05 & Chapter 06)*

The methodology employed in this study involved the use of the MAR model, which downscales global climate data to a finer spatial and temporal resolution. This approach integrated data from the ERA5 reanalysis and three ESMS from CMIP6: BCC-CSM2-MR, MPI-ESM.1.2, and MIROC6. By considering three Shared Socioeconomic Pathway (SSP) scenarios (SSP2-4.5, SSP3-7.0, and SSP5-8.5) to provide high-resolution and homogeneous weather data. The spatial and temporal resolution of the resulting weather data, at 5 km and 1-hour intervals respectively, facilitated the creation of Typical Meteorological Year (TMY) and eXtreme Meteorological Year (XMY) files, aligning with ISO 15927-4 standards., which facilitate the reconstruction of typical and extreme years while maintaining plausible variability in meteorological conditions. The research successfully generated comprehensive and high-resolution weather datasets for 12 cities in Belgium spanning the period from 1981 to 2100.

Additionally, the adopted a new approach to defining and characterizing heatwaves, moving beyond static definitions. Rather than relying on fixed criteria, the research applied a statistical method to identify and classify heatwave events based on local climate characteristics. Heatwaves were categorized based on three key criteria: duration, highest daily mean temperature, and intensity. The results indicated that heatwaves are expected to become more frequent and intense in the future, with longer durations and higher temperatures. This information is crucial for assessing the impact of heatwaves on various sectors and for developing effective adaptation strategies.

In this Ph.D. thesis, Brussels serves as a reference city for climate analysis. The thesis uses data from three Earth System Models (ESMs): BCC-CSM2-MR (MAR-BCC), MPI-ESM.1.2 (MAR-MPI), and MIROC6 (MAR-MIR). Here are summarized climate-related results for Brussels:

- **BCC-CSM2-MR:** By the 2050s (SSP5-8.5), monthly temperatures may increase by 0.5° C to 2.7° C, reaching 1.1° C to 4.1° C by the 2090s compared to the 2010s.
- **MAR-MPI (MPI-ESM.1.2):** Winter temperatures drop by 1.9°C to 2°C, while summer temperatures rise by 0.9°C to 1.4°C by the 2050s. In the 2090s, winter temperatures decrease in some SSPs and increase in SSP5-8.5. Summer temperatures increase significantly in all SSPs (up to 3.9°C).
- **MAR-MIR (MIROC6):** In SSP5-8.5, a substantial temperature increase of around 3.9°C by the 2090s compared to the 2010s is possible.

RQ4: *How do heating and cooling energy demands in the building stock change by the end of the century in response to climate change, within a comprehensive framework that considers uncertainties related to climate and renovation? (Chapter 04, Chapter 05 & Chapter 06)*

This question addresses critical knowledge gaps related to the hybrid approach used in the building stock modelling, renovation rates uncertainty, and methodological framework relied on ISO 13790. The chapter's findings shed light on the impact of climate change on heating and cooling energy demands in the Belgian building stock.

- **Top-down vs. bottom-up approach:** The research acknowledges the limitations of the top-down approach in assessing building-specific energy performance. By adopting a bottom-up methodology, the study achieves a more detailed and disaggregated representation of building stock components. This shift allows for a finer-grained analysis of energy consumption and potential improvements in heating and cooling energy demands
- **Hybrid approach:** A hybrid approach that combines elements of both the representative and typical approaches. This novel method balances the broad overview provided by the representative approach with the detailed insights offered by the typical approach. It addresses the limitation of investigating only a single case for each building type by considering multiple U values based on insulation levels. As a result, this hybrid approach provides a more nuanced perspective on the

building stock, leading to two scenarios (base scenario and BAU scenario).

- **Uncertainty in renovation rates:** Chapter 04 highlights the crucial role of renovation rates in shaping the future of the building stock. The uncertainty analysis conducted in the study assesses the impact of varying renovation rates on heating and cooling energy demands. Eight distinct renovation scenarios were explored, spanning from very pessimistic (0% renovation rate) to highly optimistic (maximum renovation rate in shallow and deep renovations).
- **ISO 13790 methodology:** The study relies on the ISO 13790 methodology, which employs a simplified hourly time step approach. This methodology provides a standardized and well-established framework for estimating heating and cooling energy needs. It ensures that the analysis is grounded in widely accepted principles and calculations, enhancing the credibility of the results.
- **Model validation:** The chapter emphasizes the validation of the building energy model, particularly for heating energy demand. By comparing model predictions with synthetic load profiles (SLPs) derived from historical data of 2500 buildings in Belgium, the research provides empirical evidence of the model's performance. This validation enhances confidence in the model's accuracy and reliability.

In the base scenario, there is a predicted a shift in energy demands in the Belgian building stock, with heating demand expected to decrease by 8% to 13% in the 2050s and 13% to 22% in the 2090s, while cooling demand is projected to increase by 39% to 65% in the 2050s and 61% to 123% in the 2090s. In BAU scenario under SSP5-8.5, cooling demand is projected to increase by 109% in the 2050s and 170% in the 2090s, while heating demand is expected to decrease by 12% and 21% in the 2050s and 2090s, respectively, compared to the 2010s base scenario.

RQ5: *How do resilient cooling strategies affect thermal comfort, energy consumption, and GHG emissions in Belgian residential building stock? (Chapter 05)*

The research employed three distinct cooling strategies: mechanical ventilation (MV), natural ventilation (NV) alongside MV, and split systems for active cooling. These strategies were sized using a climate change-sensitive approach, ensuring that they could effectively adapt to varying weather conditions and climate scenarios. Split system sizing was adapted using a climate change-sensitive approach, following the ISO 15927-2 standard. The aim was to identify a single design day per month falling within both intervals. If multiple days met the criteria, a selection process determined the unique design day. The highest temperature of the hottest design day for the 99% percentile was chosen as the maximum outdoor temperature for sizing. This approach ensured split system sizing accounted for climate change impacts and varying scenarios, enhancing resilience to future environmental changes. Design day weather data, including maximum dry bulb temperatures, were provided for different TMYs and SSP scenarios, reflecting these adaptations.

- **Energy consumption shifts and GHG emissions implications:** A significant shifts in cooling energy consumption is identified. In the 2050s, under various Shared Socioeconomic Pathway (SSP) scenarios

(SSP2-4.5, SSP3-7.0, and SSP5-8.5), cooling consumption increased substantially, ranging from 106% to 141% compared to the 2010s. This trend intensified in the 2090s, with a remarkable increase in energy demand. GHG emissions within the building sector followed a similar trajectory to energy consumption. In the 2050s, emissions surged significantly under various SSP scenarios, with substantial contributions from active cooling systems.

- **Transition to larger-capacity systems:** As temperatures continued to rise, the study highlighted the need for transitioning to larger-capacity cooling systems, especially in the 2090s. The distribution of split systems among different building types showed an increasing reliance on larger-capacity systems to meet cooling demands. This shift was particularly evident in freestanding houses, which favored large-capacity split systems.
- **Heatwaves:** Three distinct heatwaves in Belgium are evaluated, each occurring in different timeframes. The first, "Heatwave [2001-2020] (2019)," lasting for 5 days, exhibited temperature thresholds with 39% of the time exceeding 30°C, a maximum temperature of 41.0°C, and an average temperature of 28.6°C. The second, "Heatwave [2040-2060] (2054)," spanning 9 days, featured temperature thresholds with 41% of the time surpassing 30°C, a maximum temperature of 43.1°C, and an average temperature of 27.9°C. The third, "Heatwave [2080-2100] (2083)," lasting 7 days, demonstrated the most extreme conditions, with 57% of the time exceeding 30°C, a maximum temperature of 46.0°C, and an exceptionally high average temperature of 32.3°C. These findings underscore the escalating intensity and frequency of heatwaves, with the late 21st-century heatwave presenting particularly severe temperature patterns, indicative of the growing impact of climate change on extreme weather events in the region.
- **Thermal comfort:** Indoor Overheating Degree (IOhD) indicator is used to assess the thermal discomfort in different building types and weather scenarios while investigating three cooling scenarios. In Scenario 1 (MV), IOhD increases significantly in freestanding, semidetached, and terraced buildings in the 2050s and 2090s compared to the 2010s. Scenario 2 (MV and NV) intensifies IOhD increases, with freestanding and semidetached buildings showing the highest increases by the 2090s. Scenario 3 (MV, NV, and Split System) achieves remarkably low IOhD levels by the 2050s and 2090s across building types, indicating improved thermal comfort. The indoor operational temperature (IOpT) during heatwaves is also assessed, highlighting that IOpT often exceeds the desired cooling set point temperature. Resizing the split system based on peak heatwave temperatures significantly reduces IOpT, enhancing indoor thermal comfort.

RQ6: *What is the impact of integrating electric and gas heat pump technologies on the energy consumption and GHG emissions in the Belgian residential building stock? (Chapter 06)*

Two scenarios for heat pump integration in the building stock are introduced: one driven by electricity-driven heat pumps and another by gas-driven heat pumps. In the electricity-driven heat pump scenario, air-source heat pumps were used for space heating (SH) and domestic hot water (DHW) production. A

polynomial model was developed to predict the performance of these heat pumps under various conditions. The results showed that by 2050, the maximum penetration rate of electricity-driven heat pumps could reach 67.6%. This scenario significantly reduced the reliance on natural gas (NG) and fuel, decreasing total SH and DHW energy consumption by 3.23% compared to the business-as-usual (BAU) scenario. The per-dwelling energy consumption decreased from 15.6 MWh in the BAU scenario to 15.1 MWh in the electricity-driven heat pump scenario.

In the gas-driven heat pump scenario, gas-driven absorption heat pumps (GAHP) were considered for SH and DHW production. These GAHPs had a nominal heating capacity of 18.9 kW and used outdoor air as the low-temperature heat source and natural gas (NG) combustion as the high-temperature heat source. The results showed that by 2050, the maximum penetration rate of GAHP could reach 42.7%. This scenario reduced total SH and DHW energy consumption by 4.5% compared to the BAU scenario.

5.2. Contribution of the Thesis

The Ph.D. thesis makes several significant contributions to the field of climate change adaptation in the context of the Belgian residential building stock, with a focus on heating and cooling energy demands, final energy consumption, thermal comfort, and greenhouse gas (GHG) emissions. These contributions are as follows:

- **Comprehensive Review of Cooling Technologies:** The thesis addresses the underrepresentation of cooling systems in existing literature by conducting a comprehensive review of space cooling technologies in Europe. It identifies key characteristics and future development trends, providing valuable insights into sustainable cooling practices to combat rising temperatures.
- **Resilient Cooling Strategies:** The research investigates the performance of integrated active cooling systems, both electricity-driven and thermal energy-driven, under varying climate conditions, including heatwaves and power outages. It offers insights into the flexibility and resilience of these systems, informing their practical applications in buildings.
- **High-Resolution Weather Datasets:** By utilizing the MAR model, the thesis introduces high-resolution weather datasets for 12 cities in Belgium across various global Shared Socioeconomic Pathway (SSP) scenarios. These datasets encompass Typical Meteorological Year (TMY), eXtreme Meteorological Year (XMY), and detailed heatwave data, collectively providing a comprehensive and versatile toolset for climate change impact assessments, adaptation strategies, and research endeavors in the field of climate resilience.
- **Robust Methodological Framework:** The research adopts a robust methodological framework relies on ISO 13790 methodology, widely recognized for its credibility and standardized approach, with high-resolution weather datasets generated using the MAR model. Additionally, the validation of the building stock model through a rigorous comparison with synthetic load profiles (SLPs) from a dataset of 2500

buildings in Belgium enhances the reliability and applicability of the results.

- **Impact of Climate Change on Energy Demands:** The thesis employs a hybrid approach in the building to assess the impact of climate change on heating and cooling energy demands in the Belgian building stock. It considers uncertainties related to climate projections and renovation rates, enhancing the understanding of future energy consumption trends. This comprehensive approach ensures that the insights provided by the thesis are not only valuable for research purposes but also highly relevant and trustworthy for informing policy makers and stakeholders in the domain of climate adaptation and energy efficiency in buildings.
- **Integrating Resilient Cooling Technologies:** The thesis makes a contribution by integrating resilient cooling technologies into the building stock and meticulously assessing their proper sizing, particularly during heatwaves. This novel approach addresses the critical challenge of ensuring thermal comfort, energy efficiency, and greenhouse gas emissions reduction in the face of increasing temperatures, providing valuable insights for sustainable building practices and climate adaptation.
- **Integration of Heat Pump Technologies:** The thesis explores the integration of electric and gas heat pump technologies within the residential building stock. It quantifies their impact on energy consumption and GHG emissions, shedding light on the potential benefits and challenges associated with these technologies.
- **Thermal Comfort Analysis:** The research evaluates the effect of resilient cooling strategies on thermal comfort, using the Indoor Overheating Degree (IOhD) indicator. It demonstrates how different cooling scenarios impact thermal comfort in various building types and under different climate scenarios, offering insights into improving occupant well-being.
- **Policy and Practical Implications:** The findings of this thesis have practical implications for policymakers, building designers, and energy planners. They underscore the importance of sustainable and energy-efficient cooling solutions, inform policy development, and provide guidance for enhancing building sustainability in the face of climate change.

In summary, this Ph.D. thesis significantly contributes to the understanding of climate change impacts on residential buildings, offers practical insights into sustainable cooling solutions, and provides a foundation for future research, policy development, and practical applications in the field of building sustainability and climate adaptation.

5.3. Recognizing Limitations

While conducting this Ph.D. thesis, it is important to acknowledge that there were certain limitations encountered during the research process. These limitations have been meticulously detailed and addressed within the context of each respective chapter. Furthermore, it is worth noting that some of these limitations in earlier chapters have been considered as valuable inputs in subsequent chapters, leading to comprehensive and well-informed research outcomes. Below, you will find a summarized overview of these limitations, with

detailed discussions available within the relevant chapters for those seeking more in-depth information.

Chapter 01 faced limitations due to a lack of comprehensive scientific literature on alternative space cooling (SC) technologies. While conventional vapor compression (VC) cooling and heating technologies are well-documented, alternative SC systems are underrepresented, primarily because they are still in the early stages of development. This makes it challenging to determine their costs and efficiencies compared to VC technology. Additionally, the qualitative approach used for analysis, while providing in-depth insights, may not offer quantitative performance assessments. Addressing these limitations requires more research and development efforts to enhance the competitiveness of alternative SC technologies.

Chapter 02 encounters limitations primarily in the availability of literature related to the resilience of air conditioners (ACs) to heatwaves and power outages. Most research focuses on AC performance under normal conditions, and this study's unique approach draws from a substantial database to evaluate AC systems across various parameters. The second limitation arises from differences in testing conditions, climate, capacity, and operating conditions among AC systems, making direct comparisons complex.

Chapter 03 limitation lies in the omission of the Urban Heat Island (UHI) effect due to incomplete information about urbanization and human activity changes, which results in an incomplete assessment of future thermal conditions in the studied areas.

Chapter 04, chapter 05 and chapter 06 encounter some limitations as their framework relies on ISO 13790:2007, which has been replaced by ISO 52016-1. Additionally, the assumption that weather data for Brussels represents all of Belgium may overlook regional weather variations. In addition to that chapter 04 does not consider active air conditioning systems, which are relatively uncommon in Belgium's temperate climate. While, chapter 05 and chapter 06 primarily focus on specific timeframes and SSP scenarios, omitting intermediate periods and alternative SSP scenarios that could offer a more comprehensive climate impact assessment

Several limitations identified in earlier chapters have been addressed in subsequent chapters. For instance, the qualitative approach limitation mentioned in Chapter 01 and Chapter 02, which was necessary for synthesizing existing literature comprehensively, was supplemented by a quantitative assessment in Chapter 05. This addressed the need for a more practical understanding and quantitative evaluation of various cooling systems. Chapter 05 also tackled the limitation from Chapter 02 concerning the scarcity of research on the resilience of technologies against heatwaves. Additionally, Chapter 04's limitation regarding the integration of cooling technologies in the building stock was addressed in Chapter 05 by incorporating cooling technologies into the building stock and evaluating their performance and resilience during heatwave events. These strategic adaptations and integrations within the thesis contribute to a more holistic and comprehensive exploration of climate change impacts on residential buildings.

5.4. Paths for Future Research

As previously highlighted, this Ph.D. thesis has rigorously identified and discussed various limitations within its chapters, with some limitations being addressed within the scope of the research. However, certain limitations remain as potential avenues for future research to explore. The key points for future research directions can be outlined as stated below:

- Future research should encompass a comprehensive approach, including the consideration of Urban Heat Island (UHI) effects. Given the growing significance of UHI effects, incorporating UHI impact assessments can provide a more nuanced understanding of climate change impacts on thermal conditions in urban areas. Additionally, it is advisable to conduct comparative analyses between the weather data developed in Chapter 04 and data from other sources, such as CORDEX, Meteonorm, and CCWorldWeatherGen.
- Expanding the investigation and simulations to include alternative Shared Socioeconomic Pathway (SSP) scenarios, such as those with very low or low greenhouse gas emissions, can provide insights into diverse climate adaptation strategies and their implications. In addition, Extending the time horizons of climate impact assessments beyond the 2010s, the 2050s and the 2090s can offer insights into longer-term trends and adaptations required to mitigate climate change effects effectively.
- Future research should explore the implications of transitioning from the older ISO 13790 standard to the newer ISO 52016-1 standard for building energy modeling. This research could investigate how the adoption of the updated standard, with its more detailed and comprehensive modeling approach, affects the accuracy and reliability of heating and cooling demand calculations for buildings. Comparisons between the two standards in real-world scenarios could provide valuable insights into the advantages and potential challenges of implementing the newer standard in building energy assessments.
- Future research should focus on the ongoing development of alternative space cooling (SC) technologies to offer an up-to-date and comprehensive assessment of their cost-effectiveness and environmental impact. Additionally, conducting simulations to evaluate the performance of these efficient alternative technologies in real-world applications can provide valuable insights into their practical feasibility and potential benefits. This research can contribute to a more in-depth understanding of the evolving landscape of SC technologies and support informed decision-making in adopting sustainable cooling solutions.

References

- [1] Climate Change 2021: The Physical Science Basis. Contribution of Working Group I to the Sixth Assessment Report of the Intergovernmental Panel on Climate Change. Cambridge University Press; 2021.
- [2] Eyring V, Bony S, Meehl GA, Senior CA, Stevens B, Stouffer RJ, et al. Overview of the Coupled Model Intercomparison Project Phase 6 (CMIP6) experimental design and organization. *Geosci Model Dev* 2016;9:1937–58. <https://doi.org/10.5194/gmd-9-1937-2016>.
- [3] Blunden J, Boyer T. State of the Climate in 2020. *Bulletin of the American Meteorological Society* 2021;102.
- [4] Blunden J, Boyer T, Bartow-Gillies E. State of the Climate in 2022. *Bulletin of the American Meteorological Society* 2023;104:S1–516. <https://doi.org/10.1175/2023BAMSStateoftheClimate.1>.
- [5] Climate Change: Global Temperature | NOAA Climate.gov n.d. <http://www.climate.gov/news-features/understanding-climate/climate-change-global-temperature> (accessed November 1, 2023).
- [6] WMO. The global climate in 2015–2019. Geneva 2019.
- [7] Cred U. Economic Losses, Poverty & Disasters 1998-2017. Université Catholique de Louvain (UCL), Brussels, Belgium 2018;33.
- [8] MunichRE. Natural disaster risks - Rising trend in losses 2019.
- [9] European Environment Agency (EEA). Global and European temperatures 2023.
- [10] Savaresi A. The Paris Agreement: a new beginning? *Journal of Energy & Natural Resources Law* 2016;34:16–26.
- [11] Morice CP, Kennedy JJ, Rayner NA, Winn JP, Hogan E, Killick RE, et al. An updated assessment of near-surface temperature change from 1850: the HadCRUT5 data set. *Journal of Geophysical Research: Atmospheres* 2021;126:e2019JD032361.
- [12] Karl TR, Arguez A, Huang B, Lawrimore JH, McMahon JR, Menne MJ, et al. Possible artifacts of data biases in the recent global surface warming hiatus. *Science* 2015;348:1469–72.
- [13] Zhang H-M, Lawrimore JH, Huang B, Menne MJ, Yin X, Sánchez-Lugo A, et al. Updated temperature data give a sharper view of climate trends. *Eos* 2019;100.
- [14] Ohara K. Chapter 6 - Adaptation. In: Ohara K, editor. *Climate Change in the Anthropocene*, Elsevier; 2022, p. 105–23. <https://doi.org/10.1016/B978-0-12-820308-8.00008-8>.
- [15] O'Neill BC, Kriegler E, Riahi K, Ebi KL, Hallegatte S, Carter TR, et al. A new scenario framework for climate change research: the concept of shared socioeconomic pathways. *Climatic Change* 2014;122:387–400. <https://doi.org/10.1007/s10584-013-0905-2>.
- [16] Riahi K, van Vuuren DP, Kriegler E, Edmonds J, O'Neill BC, Fujimori S, et al. The Shared Socioeconomic Pathways and their energy, land use, and

greenhouse gas emissions implications: An overview. *Global Environmental Change* 2017;42:153–68.
<https://doi.org/10.1016/j.gloenvcha.2016.05.009>.

- [17] Van Ruijven BJ, De Cian E, Sue Wing I. Amplification of future energy demand growth due to climate change. *Nature Communications* 2019;10:2762.
- [18] Yalew SG, van Vliet MT, Gernaat DE, Ludwig F, Miara A, Park C, et al. Impacts of climate change on energy systems in global and regional scenarios. *Nature Energy* 2020;5:794–802.
- [19] Wan KK, Li DH, Pan W, Lam JC. Impact of climate change on building energy use in different climate zones and mitigation and adaptation implications. *Applied Energy* 2012;97:274–82.
- [20] Zuin G, Buechler R, Sun T, Zanoocco C, Galuppo F, Veloso A, et al. Extreme event counterfactual analysis of electricity consumption in Brazil: Historical impacts and future outlook under climate change. *Energy* 2023:128101.
- [21] Santamouris M. Recent progress on urban overheating and heat island research. Integrated assessment of the energy, environmental, vulnerability and health impact. Synergies with the global climate change. *Energy and Buildings* 2020;207:109482.
- [22] Gautam D, B. Bolia N. Air pollution: impact and interventions. *Air Quality, Atmosphere & Health* 2020;13:209–23.
- [23] Reyes R, Schueftan A, Ruiz C, González AD. Controlling air pollution in a context of high energy poverty levels in southern Chile: Clean air but colder houses? *Energy Policy* 2019;124:301–11.
- [24] Eom J, Hyun M, Lee J, Lee H. Increase in household energy consumption due to ambient air pollution. *Nat Energy* 2020;5:976–84.
<https://doi.org/10.1038/s41560-020-00698-1>.
- [25] Tagaris E, Liao K-J, DeLucia AJ, Deck L, Amar P, Russell AG. Potential impact of climate change on air pollution-related human health effects. *Environmental Science & Technology* 2009;43:4979–88.
- [26] Wang H, Liu L. Experimental investigation about effect of emotion state on people's thermal comfort. *Energy and Buildings* 2020;211:109789.
- [27] Bueno AM, de Paula Xavier AA, Broday EE. Evaluating the connection between thermal comfort and productivity in buildings: A systematic literature review. *Buildings* 2021;11:244.
- [28] Mansi SA, Barone G, Forzano C, Pigliautile I, Ferrara M, Pisello AL, et al. Measuring human physiological indices for thermal comfort assessment through wearable devices: A review. *Measurement* 2021;183:109872.
- [29] Lai D, Lian Z, Liu W, Guo C, Liu W, Liu K, et al. A comprehensive review of thermal comfort studies in urban open spaces. *Science of the Total Environment* 2020;742:140092.
- [30] Ma N, Aviv D, Guo H, Braham WW. Measuring the right factors: A review of variables and models for thermal comfort and indoor air quality. *Renewable and Sustainable Energy Reviews* 2021;135:110436.
- [31] Parsons K. *Human thermal comfort*. CRC press; 2019.

- [32]Salehi B, Ghanbaran AH, Maerefat M. Intelligent models to predict the indoor thermal sensation and thermal demand in steady state based on occupants' skin temperature. *Building and Environment* 2020;169:106579.
- [33]Fanger PO. Thermal comfort. Analysis and applications in environmental engineering. *Thermal Comfort Analysis and Applications in Environmental Engineering* 1970.
- [34]De Dear RJ, Brager GS, Reardon J, Nicol F. Developing an adaptive model of thermal comfort and preference/discussion. *ASHRAE Transactions* 1998;104:145.
- [35]Omrany H, Marsono AK. Optimization of building energy performance through passive design strategies. *British Journal of Applied Science & Technology* 2016;13:1–16.
- [36]Köhler B, Elnagar E, Venus D, Garzia F. D4.2: Optimized nZEB-solution sets (COST REDUCTION AND MARKET ACCELERATION FOR VIABLE NEARLY ZERO-ENERGY BUILDINGS) 2020. <https://doi.org/10.13140/RG.2.2.34488.67844>.
- [37]Elnagar E, Köhler B. Reduction of the Energy Demand With Passive Approaches in Multifamily Nearly Zero-Energy Buildings Under Different Climate Conditions. *Front Energy Res* 2020;8. <https://doi.org/10.3389/fenrg.2020.545272>.
- [38]Ozarisoy B. Energy effectiveness of passive cooling design strategies to reduce the impact of long-term heatwaves on occupants' thermal comfort in Europe: Climate change and mitigation. *Journal of Cleaner Production* 2022;330:129675.
- [39]Elnagar E, Gendebien S, Georges E, Berardi U, Doutreloup S, Lemort V. Framework to assess climate change impact on heating and cooling energy demands in building stock: A case study of Belgium in 2050 and 2100. *Energy and Buildings* 2023;298:113547. <https://doi.org/10.1016/j.enbuild.2023.113547>.
- [40]Olonscheck M, Holsten A, Kropp JP. Heating and cooling energy demand and related emissions of the German residential building stock under climate change. *Energy Policy* 2011;39:4795–806. <https://doi.org/10.1016/j.enpol.2011.06.041>.
- [41]Nik VM, Kalagasidis AS. Impact study of the climate change on the energy performance of the building stock in Stockholm considering four climate uncertainties. *Building and Environment* 2013;60:291–304.
- [42]Kelly MJ. Retrofitting the existing UK building stock. *Building Research & Information* 2009;37:196–200.
- [43]Dino IG, Akgül CM. Impact of climate change on the existing residential building stock in Turkey: An analysis on energy use, greenhouse gas emissions and occupant comfort. *Renewable Energy* 2019;141:828–46.
- [44]Streicher KN, Berger M, Panos E, Narula K, Soini MC, Patel MK. Optimal building retrofit pathways considering stock dynamics and climate change impacts. *Energy Policy* 2021;152:112220.
- [45]Lowe R. Policy and strategy challenges for climate change and building stocks. *Building Research & Information* 2009;37:206–12.

- [46] Mastrucci A, Marvuglia A, Leopold U, Benetto E. Life Cycle Assessment of building stocks from urban to transnational scales: A review. *Renewable and Sustainable Energy Reviews* 2017;74:316–32. <https://doi.org/10.1016/j.rser.2017.02.060>.
- [47] Kavgic M, Mavrogianni A, Mumovic D, Summerfield A, Stevanovic Z, Djurovic-Petrovic M. A review of bottom-up building stock models for energy consumption in the residential sector. *Building and Environment* 2010;45:1683–97. <https://doi.org/10.1016/j.buildenv.2010.01.021>.
- [48] Gendebien S, Georges E, Bertagnolio S, Lemort V. Methodology to characterize a residential building stock using a bottom-up approach: a case study applied to Belgium. *International Journal of Sustainable Energy Planning and Management* 2015:71-88 Pages. <https://doi.org/10.5278/IJSEPM.2014.4.7>.
- [49] Reiter S, Marique A-F. Toward Low Energy Cities: A Case Study of the Urban Area of Liège, Belgium. *Journal of Industrial Ecology* 2012;16:829–38. <https://doi.org/10.1111/j.1530-9290.2012.00533.x>.
- [50] Shorrock L, Dunster J. The physically-based model BREHOMES and its use in deriving scenarios for the energy use and carbon dioxide emissions of the UK housing stock. *Energy Policy* 1997;25:1027–37. [https://doi.org/10.1016/S0301-4215\(97\)00130-4](https://doi.org/10.1016/S0301-4215(97)00130-4).
- [51] Verellen E, Allacker K. Developing a Building Stock Model to Enable Clustered Renovation—The City of Leuven as Case Study. *Sustainability* 2022;14:5769. <https://doi.org/10.3390/su14105769>.
- [52] Hansen J, Sato M, Ruedy R. Perception of climate change. *Proceedings of the National Academy of Sciences* 2012;109:E2415–23. <https://doi.org/10.1073/pnas.1205276109>.
- [53] Perkins SE, Alexander LV, Nairn JR. Increasing frequency, intensity and duration of observed global heatwaves and warm spells. *Geophysical Research Letters* 2012;39. <https://doi.org/10.1029/2012GL053361>.
- [54] Silva RA, West JJ, Zhang Y, Anenberg SC, Lamarque J-F, Shindell DT, et al. Global premature mortality due to anthropogenic outdoor air pollution and the contribution of past climate change. *Environ Res Lett* 2013;8:034005. <https://doi.org/10.1088/1748-9326/8/3/034005>.
- [55] Guerreiro CBB, Foltescu V, de Leeuw F. Air quality status and trends in Europe. *Atmospheric Environment* 2014;98:376–84. <https://doi.org/10.1016/j.atmosenv.2014.09.017>.
- [56] Knez S, Štrbac S, Podbregar I. Climate change in the Western Balkans and EU Green Deal: status, mitigation and challenges. *Energy Sustain Soc* 2022;12:1. <https://doi.org/10.1186/s13705-021-00328-y>.
- [57] Lobell DB, Schlenker W, Costa-Roberts J. Climate Trends and Global Crop Production Since 1980. *Science* 2011;333:616–20. <https://doi.org/10.1126/science.1204531>.
- [58] Mora C, McKenzie T, Gaw IM, Dean JM, von Hammerstein H, Knudson TA, et al. Over half of known human pathogenic diseases can be aggravated by climate change. *Nat Clim Chang* 2022;12:869–75. <https://doi.org/10.1038/s41558-022-01426-1>.

- [59] O'Brien K, Pelling M, Patwardhan A, Hallegatte S, Maskrey A, Oki T, et al. Toward a Sustainable and Resilient Future. In: Field CB, Dahe Q, Stocker TF, Barros V, editors. *Managing the Risks of Extreme Events and Disasters to Advance Climate Change Adaptation: Special Report of the Intergovernmental Panel on Climate Change*, Cambridge: Cambridge University Press; 2012, p. 437–86. <https://doi.org/10.1017/CBO9781139177245.011>.
- [60] Zhang Y, Johansson P, Sasic Kalagasidis A. Assessment of district heating and cooling systems transition with respect to future changes in demand profiles and renewable energy supplies. *Energy Conversion and Management* 2022;268:116038. <https://doi.org/10.1016/j.enconman.2022.116038>.
- [61] IEA- International Energy Agency. *The Future of Cooling- Opportunities for energy efficient air conditioning*. 2018.
- [62] Tavakoli E, O'Donovan A, Kolokotroni M, O'Sullivan PD. Evaluating the indoor thermal resilience of ventilative cooling in non-residential low energy buildings: A review. *Building and Environment* 2022;222:109376. <https://doi.org/10.1016/j.buildenv.2022.109376>.
- [63] He B-J. Green building: A comprehensive solution to urban heat. *Energy and Buildings* 2022;271:112306. <https://doi.org/10.1016/j.enbuild.2022.112306>.
- [64] Ma D, Li X, Lin B, Zhu Y, Yue S. A dynamic intelligent building retrofit decision-making model in response to climate change. *Energy and Buildings* 2023;284:112832. <https://doi.org/10.1016/j.enbuild.2023.112832>.
- [65] Torabi Moghadam S, Lombardi P. An interactive multi-criteria spatial decision support system for energy retrofitting of building stocks using CommunityVIZ to support urban energy planning. *Building and Environment* 2019;163:106233. <https://doi.org/10.1016/j.buildenv.2019.106233>.
- [66] Manisalidis I, Stavropoulou E, Stavropoulos A, Bezirtzoglou E. Environmental and Health Impacts of Air Pollution: A Review. *Frontiers in Public Health* 2020;8.
- [67] Pourkiaei M, Romain A-C. Scoping review of indoor air quality indexes: Characterization and applications. *Journal of Building Engineering* 2023;75:106703. <https://doi.org/10.1016/j.job.2023.106703>.
- [68] Economidou M, Todeschi V, Bertoldi P, D'Agostino D, Zangheri P, Castellazzi L. Review of 50 years of EU energy efficiency policies for buildings. *Energy and Buildings* 2020;225:110322. <https://doi.org/10.1016/j.enbuild.2020.110322>.
- [69] Benmarhnia T, Schwarz L, Nori-Sarma A, Bell ML. Quantifying the impact of changing the threshold of New York City heat emergency plan in reducing heat-related illnesses. *Environ Res Lett* 2019;14:114006. <https://doi.org/10.1088/1748-9326/ab402e>.
- [70] Leão MLP, Zhang L, da Silva Júnior FMR. Effect of particulate matter (PM_{2.5} and PM₁₀) on health indicators: climate change scenarios in a Brazilian metropolis. *Environ Geochem Health* 2023;45:2229–40. <https://doi.org/10.1007/s10653-022-01331-8>.

- [71]Teasdale N, Panegyres PK. Climate change in Western Australia and its impact on human health. *The Journal of Climate Change and Health* 2023;12:100243. <https://doi.org/10.1016/j.joclim.2023.100243>.
- [72]Luschkova D, Traidl-Hoffmann C, Ludwig A. Climate change and allergies. *Allergo J Int* 2022;31:114–20. <https://doi.org/10.1007/s40629-022-00212-x>.
- [73]Singh AB, Kumar P. Climate change and allergic diseases: An overview. *Frontiers in Allergy* 2022;3.
- [74]Barchielli B, Cricenti C, Gallè F, Sabella EA, Liguori F, Da Molin G, et al. Climate Changes, Natural Resources Depletion, COVID-19 Pandemic, and Russian-Ukrainian War: What Is the Impact on Habits Change and Mental Health? *International Journal of Environmental Research and Public Health* 2022;19:11929. <https://doi.org/10.3390/ijerph191911929>.
- [75]Vergunst F, Berry HL. Climate Change and Children’s Mental Health: A Developmental Perspective. *Clinical Psychological Science* 2022;10:767–85. <https://doi.org/10.1177/21677026211040787>.
- [76]Romanello M, Napoli CD, Drummond P, Green C, Kennard H, Lampard P, et al. The 2022 report of the Lancet Countdown on health and climate change: health at the mercy of fossil fuels. *The Lancet* 2022;400:1619–54. [https://doi.org/10.1016/S0140-6736\(22\)01540-9](https://doi.org/10.1016/S0140-6736(22)01540-9).
- [77]Smith GS, Anjum E, Francis C, Deanes L, Acey C. Climate Change, Environmental Disasters, and Health Inequities: The Underlying Role of Structural Inequalities. *Curr Envir Health Rpt* 2022;9:80–9. <https://doi.org/10.1007/s40572-022-00336-w>.
- [78]Kalkan N, Young EA, Celiktas A. Solar thermal air conditioning technology reducing the footprint of solar thermal air conditioning. *Renewable and Sustainable Energy Reviews* 2012;16:6352–83. <https://doi.org/10.1016/j.rser.2012.07.014>.
- [79]Bogdan Atanasiu. Principles for nearly zero-energy buildings: Paving the way for effective implementation of policy requirements. BPIE, Brussels, Belgium; 2011.
- [80]Labban O, Chen T, Ghoniem AF, Lienhard JH, Norford LK. Next-generation HVAC: Prospects for and limitations of desiccant and membrane-based dehumidification and cooling. *Applied Energy* 2017;200:330–46. <https://doi.org/10.1016/j.apenergy.2017.05.051>.
- [81]Pezzutto S, Fazeli R, De Felice M, Sparber W. Future development of the air-conditioning market in Europe: an outlook until 2020: Future development of the AC market in Europe. *WIREs Energy Environ* 2016;5:649–69. <https://doi.org/10.1002/wene.210>.
- [82]Pezzutto S, Toleikyte A, De Felice M. Assessment of the space heating and cooling market in the EU28: a comparison between EU15 and EU13 member states. *Int J Contemp Energy* 2015;1:35–48.
- [83]EUROVENT. Statistics data on the HVAC&R market in Europe, Middle-East and Afric. n.d.
- [84]Vakiloroaya V, Samali B, Fakhar A, Pishghadam K. A review of different strategies for HVAC energy saving. *Energy Conversion and Management* 2014;77:738–54. <https://doi.org/10.1016/j.enconman.2013.10.023>.

- [85] Commission Decision C(2017)7124. Technology readiness levels (TRL): Horizon 2020—Work Programme 2014-2015 General 2020.
- [86] DoE US. DOE G 413.3-4A, Technology Readiness Assessment Guide. 2011.
- [87] Zhang C, Kazanci OB, Levinson R, Heiselberg P, Olesen BW, Chiesa G, et al. Resilient cooling strategies – A critical review and qualitative assessment. *Energy and Buildings* 2021;251:111312. <https://doi.org/10.1016/j.enbuild.2021.111312>.
- [88] Ding G. Recent developments in simulation techniques for vapour-compression refrigeration systems. *International Journal of Refrigeration* 2007;30:1119–33. <https://doi.org/10.1016/j.ijrefrig.2007.02.001>.
- [89] Barbosa JR, Ribeiro GB, de Oliveira PA. A State-of-the-Art Review of Compact Vapor Compression Refrigeration Systems and Their Applications. *Heat Transfer Engineering* 2012;33:356–74. <https://doi.org/10.1080/01457632.2012.613275>.
- [90] Elnagar E, Zeoli A, Rahif R, Attia S, Lemort V. A qualitative assessment of integrated active cooling systems: A review with a focus on system flexibility and climate resilience. *Renewable and Sustainable Energy Reviews* 2023;175:113179. <https://doi.org/10.1016/j.rser.2023.113179>.
- [91] Fischer SK, Tomlinson JJ, Hughes PJ. Energy and global warming impacts of not-in-kind and next generation CFC and HCFC alternatives. *AFEAS*; 1994.
- [92] Steven Brown J, Domanski PA. Review of alternative cooling technologies. *Applied Thermal Engineering* 2014;64:252–62. <https://doi.org/10.1016/j.applthermaleng.2013.12.014>.
- [93] Goetzler W, Zogg R, Young J, Johnson C. Alternatives to Vapor-Compression HVAC Technology. *ASHRAE Journal*, vol. 56, 2014, p. 12–23.
- [94] Goetzler W, Corporate BTO, Shandross RA, Young JV, Petritchenko O, Ringo DFP, et al. Energy Savings Potential and RD&D Opportunities for Commercial Building HVAC Systems. 2017.
- [95] VHK, ARMINES, Viegand & Maagøe ApS (VM), Wuppertal Institute for Climate, Environment and Energy GmbH. Technology Roadmap in Preparatory/Review Study on Commission Regulation (EC) No. 643/2009 with Regard to Ecodesign Requirements for Household Refrigeration Appliances and Commission Delegated Regulation (EU) No. 1060/2010 with Regard to Energy Labelling. 2016.
- [96] Pezzutto S, Quaglino G, Riviere P, Kranzl L, Novelli A, Zambito A, et al. Screening of Cooling Technologies in Europe: Alternatives to Vapour Compression and Possible Market Developments. *Sustainability* 2022;14:2971. <https://doi.org/10.3390/su14052971>.
- [97] Okpalike C, Okeke FO, Ezema EC, Oforji PI, Igwe AE. Effects of Renovation on Ventilation and Energy Saving in Residential Building. *Civil Engineering Journal* 2022;7:124–34. <https://doi.org/10.28991/CEJ-SP2021-07-09>.

- [98] Royal Meteorological Institute of Belgium,. Rapport climatique 2020 de l'information aux services climatiques. Brussels Belgium: 2020.
- [99] FPS Public Health, Food Chain Safety and Environment of Belgium. Hittegolf en Ozonpiekenplan. 2008.
- [100] International Organization for Standardization. EN ISO 13790:2008 - Energy performance of buildings. Calculation of energy use for space heating and cooling: BSI British Standards; n.d. <https://doi.org/10.3403/30133624>.
- [101] Georges E, Gendebien S, Dechesne B, Bertagnolio S, Lemort V. Impact of the integration of various heating technologies on the energy load profiles of the Belgian residential building stock. Proceedings of IRES 2013 conference, 2013.
- [102] Li Y, O'Neill Z, Zhang L, Chen J, Im P, DeGraw J. Grey-box modeling and application for building energy simulations - A critical review. Renewable and Sustainable Energy Reviews 2021;146:111174. <https://doi.org/10.1016/j.rser.2021.111174>.

Appendices

Appendix A

Chapter 01: *A comprehensive scouting of space cooling technologies in Europe: Key characteristics and development trends.*

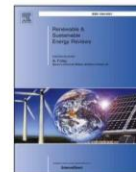

A comprehensive scouting of space cooling technologies in Europe: Key characteristics and development trends

Essam Elnagar^{a,b,*}, Simon Pezzutto^a, Bruno Duplessis^c, Théodore Fontenaille^c, Vincent Lemort^b

^a Institute for Renewable Energy, European Academy of Bolzano (EURAC Research), Viale Druso 1, 39100, Bolzano, Italy

^b Thermodynamics Laboratory, Aerospace and Mechanical Engineering Department, Faculty of Applied Sciences, University of Liège, Belgium

^c Mines Paris - PSL, PSL Research University, Centre for Energy Efficiency of Systems, 60 Boulevard Saint-Michel, 75272, Paris, France

ARTICLE INFO

Keywords:

Space cooling
Alternative cooling technologies
Vapour compression
Residential sector
Development trends
Costs

ABSTRACT

This paper presents a comprehensive taxonomy and assessment of existing and emerging space cooling technologies in Europe. The study aims to categorize 32 alternative space cooling technologies based on eight scouting parameters (physical energy form, basic working/operating principle, refrigerant or heat transfer medium, phase of the working fluid, specific physical process/device, type of space cooling technology, fuel type and technology readiness level) and evaluate their key characteristics and development trends. The increasing demand for space cooling in Europe necessitates a thorough understanding of these technologies and their potential for energy efficiency. The majority of space cooling demand in Europe is currently met by conventional vapour compression systems, while a small portion is covered by thermally-driven heat pumps. The study reveals that several alternative space cooling technologies show promise for energy-efficient cooling but are not yet competitive with vapour compression systems in terms of efficiency and cost in the short-term and medium-term. However, technologies such as membrane heat pumps, thermionic systems, thermotunnel systems, and evaporative liquid desiccant systems demonstrate cost-competitiveness and energy efficiency in specific applications. The findings highlight the need for further research and development to improve the efficiency, costs, and market competitiveness of alternative space cooling technologies. The study also emphasizes the importance of policy support and the urgency to reduce greenhouse gas emissions, which can drive the adoption and advancement of sustainable cooling solutions.

1. Introduction

The need for space cooling (SC) has a significant impact on overall electricity consumption since buildings account for about 40% of Europe's primary energy use [1,2]. It is estimated that air-conditioning systems in residential and commercial buildings account for about 45% of the total electricity consumption [3,4].

The primary energy consumption in the EU in 2018 was 1600 Mtoe/y, which is 5% more than the 2020 objective and 22% more than the 2030 target. The final energy consumption in 2018 was 3% and 22% higher than in 2020 and 2030, respectively [5–7]. The major contributor to primary energy consumption is the heating and cooling sector [8,9]. Space heating, SC, domestic hot water (DHW) and industrial heat and cold account for 50% of the primary energy consumption [10].

SC is defined as the process of cooling indoor air by removing heat from the air and providing buildings' occupants with thermal comfort [11], while process cooling (PC) refers to the removal of unwanted heat from processes (cooling a product, cooling a specific process or cooling a machine) to ensure the continuation of the process safely and reliably. There are various applications for SC in different sectors (tertiary and residential). Currently, SC is the building energy end-use with the highest rate of growth since 1990, with an almost tripled energy demand. This growth in SC consumption is due to different factors such as climate change, extreme heatwaves, urbanization and new building constructions with increased glazing surfaces [12–14].

Vapour compression (VC) air-conditioning systems account for about 99% of the market for SC technologies [8,15]. The thermally-driven heat pumps (TDHPs) supply the remaining 1% of the SC need in the EU market [16]. Therefore, the potential for significant energy savings is

* Corresponding author. Thermodynamics Laboratory, Aerospace and Mechanical Engineering Department, Faculty of Applied Sciences, University of Liège, Belgium.

E-mail address: essam.elnagar@uliege.be (E. Elnagar).

<https://doi.org/10.1016/j.rser.2023.113636>

Received 2 May 2023; Received in revised form 8 August 2023; Accepted 9 August 2023

Available online 25 August 2023

1364-0321/© 2023 The Authors. Published by Elsevier Ltd. This is an open access article under the CC BY license (<http://creativecommons.org/licenses/by/4.0/>).

Abbreviations:

Centralized Air-Conditioners CACs
 Chlorofluorocarbon CFC
 Coefficient of Performance COP
 Domestic hot water DHW
 Energy Efficiency Ratio EER
 Global Warming Potential GWP
 Greenhouse gas GHG
 Heating, ventilation, and air-conditioning HVAC
 Hydrochlorofluorocarbon HCFC
 Hydrofluorocarbon HFC

Ozone Depletion Potential ODP
 Photovoltaic PV
 Process cooling PC
 Room-Air Conditioners RACs
 Seasonal Energy Efficiency Ratio SEER
 Seasonal Performance Factor SPF
 Space cooling SC
 Technology Readiness Level TRL
 Thermally-driven heat pumps TDHPs
 Variable Refrigerant Flow VRF
 Vapour compression VC

made attractive by performance upgrades to conventional VC systems [17]. Due to their low operating costs, low investment costs, and high efficiency, VC systems have taken the lead in the market. It has become vital to assess potential alternative SC technologies since halogenated alkanes, the most extensively utilized refrigerants in VC systems, contribute to climate change and Greenhouse Gas (GHG) emissions.

Following EU regulations, the main focus recently has been on increasing the efficiency of the systems and using refrigerants with low Global Warming Potential (GWP) to lessen the impact of air-conditioning systems on climate change. It is worthwhile to assess the most recent developments in alternative SC technologies and determine whether or not they are at a point where they can compete with the conventional VC systems, which are ranked by their Technology Readiness Level (TRL) [18,19]. The performance and physical principle of VC systems have been the subject of a very large number of studies on SC technologies (see, for instance [20–23]). On the other hand, several studies [23–26] have concentrated on alternatives (e.g. TDHPs).

The goal of the industry was to utilize refrigerants with no Ozone Depletion Potential (ODP) already about 30 years ago [27]. Therefore, Chlorofluorocarbon (CFC) and hydrochlorofluorocarbon (HCFC) refrigerant use was eliminated through the investigation of alternative cooling (SC and PC) systems in a study by Fischer et al. [28] in which they investigated ten alternative cooling systems. Due to this, another study by Brown et al. [15] used Fischer et al. [28] findings as the main “marker” to assess alternative cooling technologies. Goetzler et al. [29] evaluated the alternatives in the heating, ventilation, and air-conditioning (HVAC) industry in order to provide critical suggestions in response to the U.S. Department of Energy’s (DOE) decision to reduce support for VC systems. In addition to that, Goetzler et al. [30] recommendations to the stakeholders and DOE on future research broadened the range of alternative technologies that potentially minimize commercial HVAC energy demand. A recent study by Goetzler et al. [31] assessed earlier HVAC research studies to take into account new and developing technologies.

The thermally-driven SC technologies from combined cooling, heating & power (CCHP) systems were also evaluated in previous studies. Deng et al. [32] described the CCHP’s operating principles in depth, highlighting the benefits of desiccant cooling, adsorption, absorption refrigeration systems, and other technologies. Additionally, another study by Montagnino et al. [33] discussed solar cooling technologies, including small-scale and large-scale systems. According to the study, the photovoltaic (PV) system will help the VC systems maintain its lead in the market share due to the decrease in the cost of PV nowadays and also in the coming years. Another recent study by Elnagar et al. [23] found that thermally-driven cooling technologies have a unique advantage over conventional electricity-driven cooling systems. These technologies can be powered by different thermal energy sources, providing greater flexibility in terms of energy sources. Additionally, thermally-driven cooling systems typically require less electrical input, making them more resilient against power outages. This can be

particularly advantageous in areas with unstable electricity grids or during times of widespread power outages. The low electrical input also makes thermally-driven cooling systems more sustainable and environmentally friendly.

According to a recent study by Pezzutto et al. [27], there will not be any alternative cooling technologies available between 2020 and 2030 in the EU market that can compete with VC systems. The study also presented a taxonomy of cooling systems (SC and PC).

1.1. Literature review

Various SC technologies that are already on the market as well as emerging technologies, are evaluated for this study through a comprehensive analysis of the literature. Additionally, a patent search over the previous ten years is included to find the most promising SC technologies, taking into account the International Patent Classification (IPC) codes “F24F (Air-conditioning, Air-humidification, Ventilation, Use of air currents for screening)”, and “F25 (Refrigeration or cooling; combined heating and refrigeration systems; heat pump systems; manufacture or storage of ice; liquefaction or solidification of gases)” [34,35].

This paper investigates SC technologies using a number of studies as the main sources. In the 1990s, a study by Fischer et al. [28] discussed the chemical and technological alternatives to CFCs by 2000. Additionally, the analysis was expanded to consider how these substitutes might affect global warming, with a focus on HCFCs and hydrofluorocarbons (HFCs) as CFC alternatives. Technologies including thermoelastic heat pumps, evaporative cooling, Stirling cycle refrigerators, and Malone cycle refrigerators were covered by Fischer et al. [27].

Within the framework of the study by Fischer et al. [28], another study by Brown et al. [15] reviewed alternative cooling systems in 2014. The study discussed a number of technologies by outlining their physical working principles, present technological state, and market potential. The main goal of the study was to categorize cooling technologies according to their main source of energy, such as electrical, mechanical, chemical, magnetic acoustic, thermal, potential and “natural”. Due to their high market maturity and expected high-performance potential, six technologies—thermoelectric, sorption, desiccant, magnetic, thermoacoustic, and transcritical CO₂ cycle—were discussed in this study. The study also evaluated various competing SC technologies and came to the conclusion that they would not be able to compete with VC technologies in the near future.

In 2014, Goetzler et al. [36] conducted another important study with the HVAC industry as the primary focus. The study identified sustainable alternatives to HVAC and VC technologies. The study gave an in-depth analysis of the different technologies and noted that the electrocaloric, critical-flow refrigeration and Bernoulli heat pump technologies were still in the early stages of research and development. The final technology list included magnetocaloric, thermoacoustic, thermoelastic, thermoelectric, thermotunneling, Vuilleumier heat pumps, sorption heat pumps, Brayton heat pumps, ejector heat pumps, duplex Stirling

cycle, desiccant cooling systems, and membrane heat pumps, among others. The vortex-tube and pulse-tube cooling systems, which are more suited for PC applications [37], were not included in this study, which primarily focused on SC applications. The amount of energy saved per unit was estimated. Using the VC system as a baseline, a scorecard analysis was made.

Another study by Goetzler et al. [30] in 2017 led to updates and advancements in the Research and Development (R&D) of alternative cooling methods taken into account in the same study from 2014 [36]. The study investigated four categories of eighteen technologies, the first of which is “Technology Enhancements for Current Systems”. The second category is referred to as “Alternative Gas-Fired Heat Pumps Technologies”, and it more efficiently offers heating and cooling by mostly making use of natural gas and thermally activated heat pump cycles. The third group, known as “Alternative Electrically Driven Heat Pump Technologies,” uses electricity as its primary energy source through the use of VC and non-VC systems to provide more efficient heating and cooling. The fourth category, “Alternative System Architecture,” includes robotic devices, wearable comfort gadgets, and dynamic cooling garment technologies. This category intends to reduce HVAC system operating costs by enhancing building comfort.

Recently, Goetzler et al. [31] included recent HVAC technologies, appliances, refrigeration and water heating. The study divided the investigated technologies into five groups. The most relevant data for the current study was in the fifth group, named “Cross-Cutting”, which includes materials and systems for thermal energy storage, VC with modulating capability, and non-vapour compression (NVC). It has been found that previous studies predict energy savings of 20% regarding the NVC technologies compared to the current VC technologies, which may offer more possibilities for use in the building sector.

VHK et al. [38] conducted a significant study in 2016. The study compared the market-available “best cooling technologies” with others that are non-available in the market. The study identified a number of non-commercial cooling technologies as being particularly promising, including magnetic refrigeration, Lorenz-Meutzner cycle refrigeration, Stirling cycle refrigeration, ejector cycle refrigeration, thermoacoustic refrigeration, and thermoelastic refrigeration.

Lastly, Pezzutto et al. [11,27] focused on the European market from 2020 to 2030. The study developed a taxonomy for cooling technologies (SC and PC). It has been found that membrane heat pumps, Reverse Brayton (Bell Coleman cycle), transcritical cycle, and absorption cooling are promising technologies and might compete with VC systems.

In terms of methodology, the literature review heavily relies on existing studies and patent searches to gather information about the different cooling technologies. However, a thorough review study is still required that focuses on the key characteristics of SC technologies. This paper focuses on technologies that are applicable to SC applications. However, there are a few parts of the text which refer both to space and process cooling.

First, the present study gives an overview of the conventional VC systems and their classification based on the generation and distribution systems as well as the major characteristics and costs. Secondly, the main focus of the study is to provide a taxonomy for all existing and emerging SC technologies following the previous research while taking into account new emerging technologies that have not been evaluated in previous studies. The SC technologies are grouped in this taxonomy according to the physical energy form, basic working/operating principle, refrigerant/heat transfer medium, phase of the working fluid, particular physical process/device, type of SC technology (active, passive, or both), fuel type and TRL. The study investigates 32 alternative SC technologies by describing their major technical characteristics, costs and development trends, as shown in Fig. 2.

The paper is organized as follows. The paper is organized as follows. The methodology for this review, including the primary scientific sources, is presented in Section 2. The results are presented in section 3, (section 3.1) presents the complete SC taxonomy, (section 3.2) presents

the conventional VC systems and (section 3.3) presents the alternative SC technologies. Section 4 discusses the key findings and recommendations of the study, the strength and limitations, as well as the implication on practice and future research. Finally, section 5 concludes the recommendations and the implications on the practice of the study.

2. Review methodology

A thorough analysis of multiple sources was the base of an effective methodology that was used to create a comprehensive taxonomy of alternative SC technologies. The studies stated above [13,15,28,30,31,36,38] are the main resources for the technologies scouting phase. Only the most recent sources were used in this study. Since the effort intends to provide a state-of-the-art cooling technology, this is mostly owing to enhanced information and data reliability. The study aims to evaluate the current status of alternative SC technologies and their development trends.

The primary energy input was the key parameter used to categorize cooling technologies in an earlier study by Brown et al. [15]. Additionally, other taxonomies could be developed by incorporating additional parameters, such as the operating temperature range (low, medium, or high) and operational fluid phases (gaseous, liquid, solid or multiphase). To develop the cooling taxonomy, a recent study by Pezzutto et al. [27] categorized each cooling technology according to the physical form of energy input (electrical, mechanical, chemical, magnetic acoustic, thermal, potential and “natural”). The study also included system efficiency, applications and TRL.

In this paper, the scouting parameters used to categorize the alternative SC technologies are shown in Fig. 1. This study focuses only on SC technologies and categorizes them based on eight parameters as follows: physical energy form, basic working/operating principle, refrigerant or heat transfer medium, phase of the working fluid, specific physical process/device, type of SC technology (active, passive or both), fuel (fuel type used to drive the SC technology, the possibility to be driven by renewable energy source) and TRL.

The eight parameters are explained as follows: there are seven types

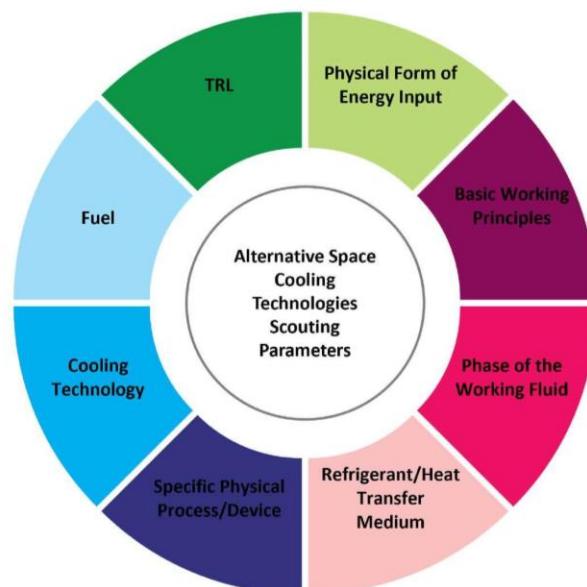

Fig. 1. Alternative space cooling technologies scouting parameters.

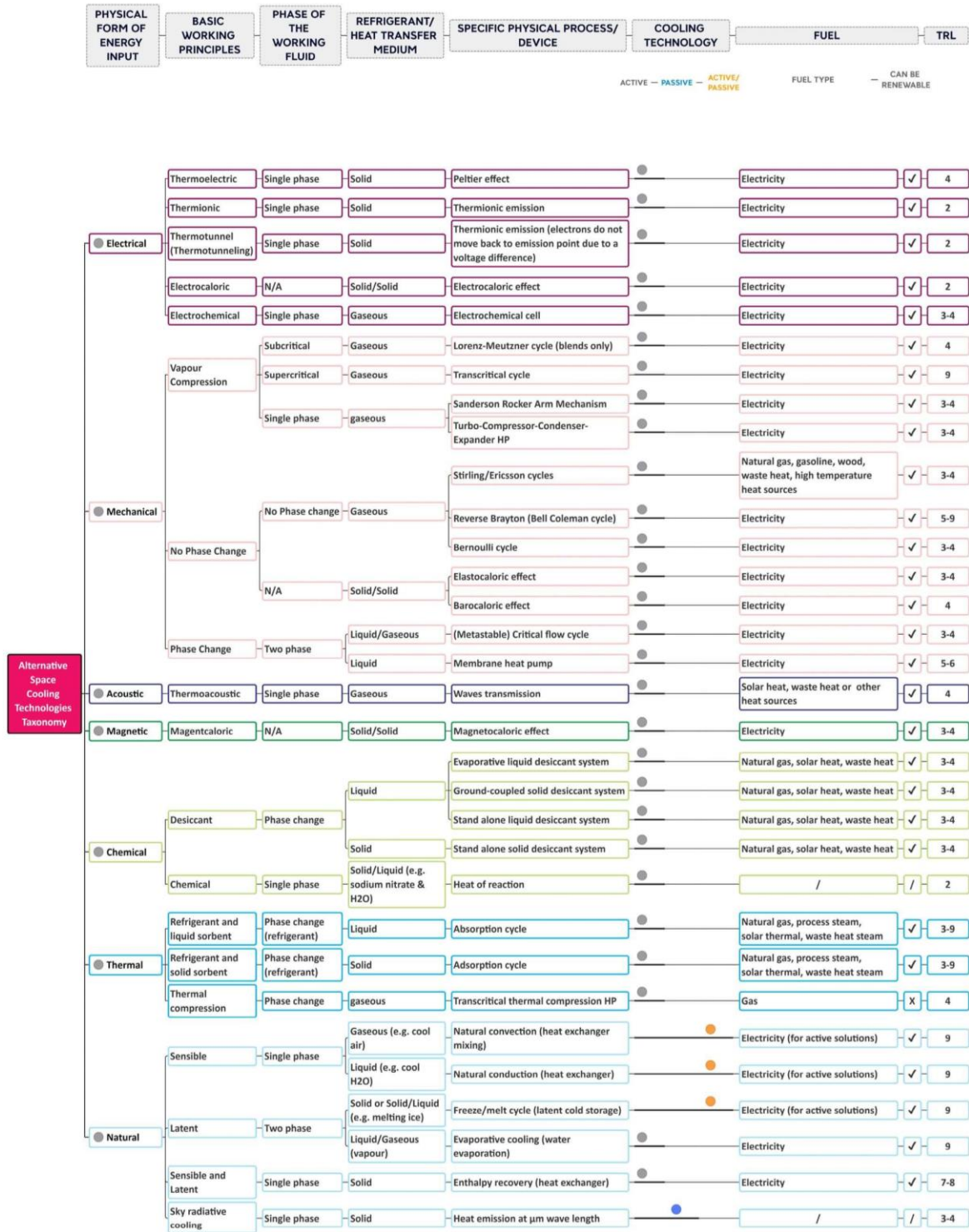

Fig. 2. Cooling technologies taxonomy.

Table 1
Space cooling technologies list.

The physical form of energy input	SC Technologies
Electrical	Peltier effect, Thermionic effect, thermotunneling, electrocaloric effect, electrochemical effect
Mechanical	Reverse Rankine, Transcritical cycle, Turbo-Compressor-Condenser-Expander heat pump, Lorenz-Meutzner Cycle, Sanderson Rocker Arm, Stirling/Ericsson cycles, reverse Brayton (Bell Coleman cycle), Bernoulli cycle, elastocaloric effect, barocaloric effect, (Metastable) critical flow cycle, membrane heat pump
Acoustic	Thermoacoustic (waves transmission)
Magnetic	Magnetocaloric
Chemical	Desiccant systems, heat of reaction (endothermic)
Thermal	Absorption and adsorption cycles, transcritical thermal compression heat pump
“Natural”	Natural conduction (heat exchanger), natural convection (heat exchanger mixing), evaporative cooling (water evaporation), sky radiative cooling, freeze/melt cycle (latent cold storage) and enthalpy recovery (heat exchanger)

of energy in the physical form of energy input (electrical, mechanical, chemical, magnetic acoustic, thermal, potential and “natural”). The state of the working fluid determines whether it is in a single-phase, two-phase, no-phase change, subcritical, or supercritical condition. The working fluid’s phase is irrelevant for caloric systems since there is not a working fluid in the vast majority of them; instead, the fluid just acts as a heat carrier and doesn’t undergo any phase change. The refrigerant/heat transfer medium explains the medium’s phase (solid, gaseous liquid, or multiphase). The specific physical process/device refers to the used device in the cooling technology, which is specifically designed to remove heat from an object, material or environment to achieve a desired cooling effect. According to the area of intervention, the type of SC technology parameter shows the type of SC technology (active, passive, or both). Additionally, the parameter “fuel” is used to denote the sort of fuel utilized to power SC appliances (in particular, renewable or not). TRL, the final parameter in the taxonomy, is used to describe the life stages of technologies in the development process, from the initial concept through the existing application in the market.

TRL is a system for assessing technology maturity, “TRL is based on a scale from 1 to 9, with 9 being the most advanced technology”, according to the Guide for Technology Readiness Assessment of the U.S. Department of Energy [19].

Table 2
Purchasing prices for room air-conditioners (RACs) and centralized air-conditioners (CACs) [€/unit] for the reference year 2016 [11,48].

System type	Mean purchasing costs [€/unit]
RACs	
Movable systems	409
Split systems (capacity <5 kW)	1051
Multi-split systems (capacity >5 kW, including single ducted systems)	1692
CACs	
Rooftop + packaged units	18135
Chiller (air-to-water) (capacity <400 kW)	20768
Chiller (water-to-water) (capacity <400 kW)	1676
Chiller (air-to-water) (capacity >400 kW)	111370
Chiller (water-to-water) (capacity >400 kW)	88033
VRF systems	19720

Table 3
Installation costs for room air-conditioners (RACs) and centralized air-conditioners (CACs) [€/kW] for the reference year 2016 [11,41].

System type	Mean installation costs [€/kW]
RACs	
Movable systems	164
Split systems (capacity <5 kW)	300
Multi-split systems (capacity >5 kW, including single ducted systems)	226
CACs	
Rooftop + packaged units	279
Chiller (air-to-water) (capacity <400 kW)	260
Chiller (water-to-water) (capacity <400 kW)	173
Chiller (air-to-water) (capacity >400 kW)	181
Chiller (water-to-water) (capacity >400 kW)	117
VRF systems	789

The TRL is defined by the H2020 EU research program, resulting in the list below [18].

- “TRL 1: Observing and reporting of basic principles.
- TRL 2: Formulation of technology concept and/or application.
- TRL 3: Proof-of-concept through critical function and/or characteristic analysis and experimentation.
- TRL 4: Validation of component and/or breadboard in a laboratory environment.

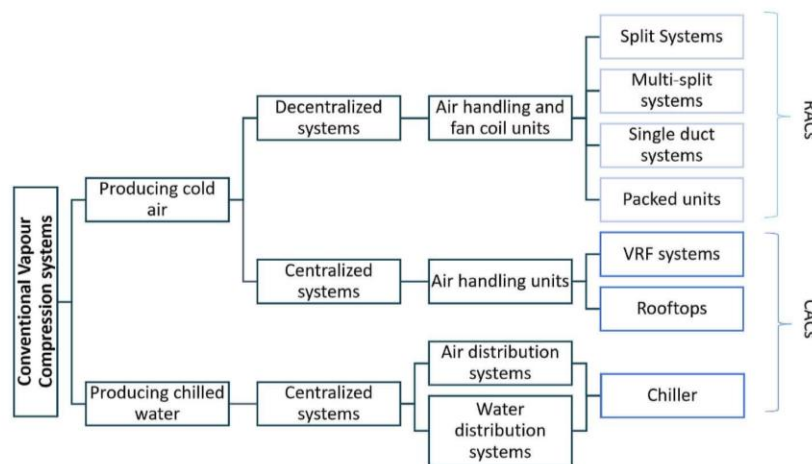

Fig. 3. Classification of conventional vapour compression systems.

Table 4
Operation and Maintenance (O&M) costs for room air-conditioners (RACs) and centralized air-conditioners (CACs) [€/kW] for the reference year 2016 [11,48].

System type	Mean (O&M) costs [€/unit/year]
RACs	
Movable systems	/
Split systems (capacity <5 kW)	42
Multi-split systems (capacity >5 kW, including single ducted systems)	68
CACs	
Rooftop + packaged units	725
Chiller (air-to-water) (capacity <400 kW)	830
Chiller (water-to-water) (capacity <400 kW)	787
Chiller (air-to-water) (capacity >400 kW)	4455
Chiller (water-to-water) (capacity >400 kW)	3521
VRF systems	789

- TRL 5: Validation of component and/or breadboard in a relevant environment.
- TRL 6: Demonstration of system/subsystem model or prototype in a relevant environment.
- TRL 7: Demonstration of system prototype in an operational environment.
- TRL 8: Completion and qualification of the actual system through testing and demonstration.
- TRL 9: Proven success of actual system through mission operations."

The cooling technologies in this study require TRL levels of 5–9 to be commercially viable. A TRL level of 8–9 would also be ideal for systems that are already on the market.

Furthermore, the study describes the major characteristics of the SC technologies – among others: on-site and/or off-site sources, cold sources and reference sink temperatures, resource usage type, such as water consumption or refrigerant leaks, efficiency levels, costs and development trends.

3. Space cooling technologies

3.1. Taxonomy of space cooling technologies

This study only focuses on SC technologies and extends the previous studies by adding various parameters to categorize the technologies in Fig. 2, which shows the final taxonomy of the alternative SC technologies. In addition to that, the study provides a comparison between the alternative SC technologies based on their TRL level to show their willingness to compete in the market with the conventional VC systems. Therefore, section 3.2 gives an overview of the conventional VC systems, including their major characteristics, costs and development trends. Section 3.3 explains the alternative SC systems by including new technologies that have not been studied before by Brown et al. [15] and Pezzutto et al. [27], such as the elastocaloric effect and barocaloric effect. Finally, the taxonomy results in the technologies introduced in Table 1.

Section 3.3 also represents the major characteristics of the alternative SC technologies, which include fuel type used, cold source, reference sink temperature, resource usage, range of available size per type of the system, and efficiency level (Energy Efficiency Ratio – EER, Seasonal Energy Efficiency Ratio – SEER, Coefficient of performance – COP, Seasonal Performance Factor – SPF, etc.). For VC systems, the efficiency is typically measured according to industry standards such as AHRI 210/240 or ISO 5151 [39,40]. For alternative SC technologies, the efficiency can be measured efficiency based on the boundary condition of each system or anticipated efficiency based on the heat input required to drive the cooling cycle. In addition to that, development trends, including the TRL, are also discussed for each technology.

Table 5
Efficiency and costs of alternative space cooling technologies (unknown is when a source mentions that efficiency and costs are not known, while not identified is when the information is not found in any source).

Technology	Efficiency	Costs
Thermoelectric	Lower [30]	Equal (Assumption) [50]
Thermionic	Higher (Assumption) [30]	Equal (Assumption) [30]
Thermotunnel	Higher (Assumption) [30]	Equal (Assumption) [29]
Electrocaloric	Higher (Assumption) [30]	Unknown
Electrochemical	Higher (Assumption) [50]	Unknown
Lorenz-Meutzner cycle (blends only)	Higher (Assumption) [51]	Not identified
Transcritical cycle	Unknown	Higher [30]
Sanderson Rocker Arm Mechanism	Unknown	Unknown
Turbo-Compressor-Condenser-Expander HP	Higher (Assumption) [30]	Unknown
Stirling/Ericsson cycles (Reverse Stirling, Duplex Stirling, Reverse Ericsson)	Lower [29,30]	Unknown
Reverse Brayton (Bell Coleman cycle)	Lower [30]	Not identified
Bernoulli cycle	Lower [36]	Equal (Assumption) [29]
Elastocaloric effect	Higher [29,52]	Not identified
Barocaloric effect	Higher [52]	Not identified
(Metastable) Critical flow cycle	Lower [36]	Unknown
Membrane HP	Higher (Assumption) [30]	Equal (Assumption) [29]
Thermoacoustic	Lower [36]	Equal (Assumption) [29]
Magnetocaloric effect	Higher [29,52]	Unknown
Evaporative liquid desiccant system	Higher (Assumption) [30]	Equal (Assumption) [30]
Ground-coupled solid desiccant system	Higher [29]	Higher (Assumption) [30]
Stand-alone liquid desiccant system	Lower [30]	Higher (Assumption) [30]
Stand-alone solid desiccant system	Lower [29]	Higher [30]
Heat of reaction	Unknown	Not identified
Absorption and Adsorption cycles	Lower [29]	Higher [29]
Transcritical Thermal Compression HP	Lower [30]	Higher [29]
Natural Convection (Heat Exchanger–Mixing)	Not identified	Not identified
Natural Conduction (Heat Exchanger)	Not identified	Not identified
Freeze/Melt Cycle (Latent Cold Storage)	Not identified	Not identified
Evaporative Cooling (Water Evaporation)	Not identified	Equal (when used as an independent system) [30]
Enthalpy Recovery (Heat Exchanger)	Not identified	Not identified
Sky Radiative Cooling	Not identified	Unknown

3.2. Conventional vapour compression systems

Among various SC technologies, conventional VC systems are now dominating the market for a number of reasons as follows: their scalability, low cost, relatively compact size, use of non-flammable and non-toxic refrigerants and high efficiency [41]. Nearly 99% of Europe's SC demands are met by VC systems [8,15]. VC technologies have a TRL level of up to 9 since they are already actual systems in the different

Concept	Formulation	Lab Test	Lab Prototype	Lab-scale plant	Pilot plant	Demonstration	Commercial refinement required	Commercial
TRL1	TRL2	TRL3	TRL4	TRL5	TRL6	TRL7	TRL8	TRL9

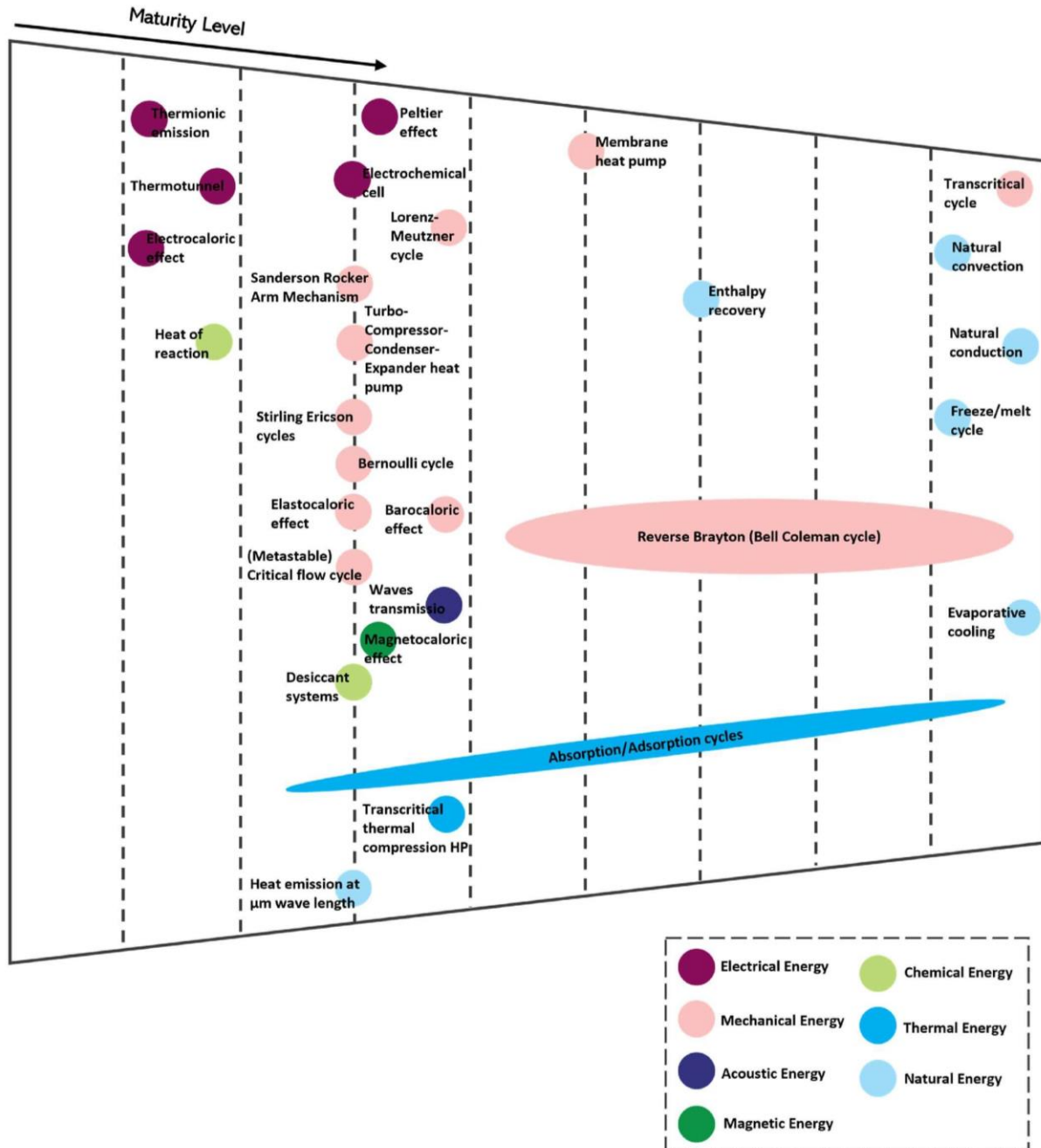

Fig. 4. TRL of alternative space cooling technologies.

sectors of the market. It must be stressed that flammable fluids are more and more used, among others, due to efforts to limit the refrigerant charge.

As shown in Fig. 3, conventional VC air-conditioning systems are split into two categories according to the generation of systems that produce cold air and chilled water, as well as the distribution to centralized systems and decentralized systems. Centralized air-conditioners (CACs) and decentralized systems, which are known as room-air-conditioners (RACs), are the two main types of VC air-conditioning systems. CACs refer to systems with a single base location which is used to cool the whole building, while RACs are used to cool a single space. RACs come in four different types (split systems, multi-split systems, single duct systems, and packaged units), while there are three different types of CACs (Variable Refrigerant Flow - VRF systems, rooftop systems, and chillers).

The physical principle of the different types of conventional VC systems is explained in this section. Although they are also used in the tertiary, particularly in offices, RACs are most frequently used in the residential sector. CACs are also used in households but mostly in the tertiary sector [42].

3.2.1. Split systems

Split air-conditioning refers to a reversible air source heat pump with one indoor unit and one outdoor unit. The indoor unit is located inside the building and has an air filter and evaporator coil. The condensing unit (outdoor unit) is located outside the building and has a compressor and condenser coils [43].

3.2.2. Multi-split systems

Multi-split systems are air-conditioning systems that have several indoor units as well as one outdoor unit. The total number of indoor units determines the maximum cooling capacity of a multi-split system.

3.2.3. Packaged units

A packaged air-conditioning unit is also known as a unitary air-conditioning system. A standard packaged air-conditioning system's components are all housed in a single casing and include a condenser, an evaporator, a compressor and an expansion valve. Packaged units are also referred to as "through-the-wall-air conditioners" because of the way they are mounted in residential structures [42,44].

3.2.4. Portable unit systems

Portable unit systems are also known as moveable unit systems, where all the system's parts are contained in the same cabinet and designed to be easily carried inside the building. There is relatively little installation needed for the system. The condenser, which circulates the refrigerant (the cooling medium), draws in the indoor air to be cooled. The refrigerant is then rejected outside through a duct.

3.2.5. Rooftop units

Rooftop units, often referred to as outdoor packed units, are typically available in large capacities located on the building's roof and use ducts to cool the buildings. In order to fulfil the requirements of medium-to-large-sized buildings, rooftop systems are offered in a variety of capacities.

3.2.6. Chillers

Chillers are large air-conditioning systems that produce chilled water and distribute it to cooling coils in air handling units that cool the indoor air and terminal units through a cooling network of heat exchangers and pipes. Three distinct types of chillers are available (air-cooled, water-cooled and evaporative-cooled).

3.2.7. Variable Refrigerant Flow (VRF) systems

VRF system, sometimes referred to as a VRV (variable refrigerant volume) system, consists of a single outdoor condensing unit that

Table 6
Stirling/Ericsson cycles characteristics.

System	Reference sink temperature	Range of capacity installed
Reverse Stirling	20–50 °C [67,68]	40–100 W [69]
Duplex Stirling	approximately 17 °C [70]	50 W–20 kW [71]
Vuilleumier HP	500 °C and higher [36]	7.5–20 kW [36]
Reverse Ericsson	about 30 °C [72]	Around 700 W [73]

distributes refrigerant to several indoor units. VRF systems typically have more cooling capacity than conventional split systems.

The major characteristics (fuel type used, cold source, reference sink temperature, resource usage, range of available size per type of the system, and efficiency level), costs and development trends of the conventional VC systems are explained as follows.

- **Fuel type used:** Electricity
- **Cold source:** air or water
- **Reference sink temperature:** an inlet temperature of 27–35 °C for air-to-air systems, 35 °C for air-to-water systems, and 30 °C for water-to-water [45].
- **Resource usage:** refrigerant
- **Range of capacity installed:** for conventional VC technologies, the range of capacity installed varies mainly between RACs and CACs. The range goes from about 3 to more than 150 kW [13].
- **Energy efficiency:** energy efficiency (SEER) of VC technologies varies among 2–5 (for currently installed technologies in Europe). The mean SEER of VC technologies is estimated to be 2.7 for portable appliances and 5.7 for split systems [46], and around 4–4.5 on average in the EU [47].
- **Costs (investment, installation, operation and maintenance):** Purchasing prices for RACs and CACs are shown in Table 2 [42]. As a result, the average cost of purchasing RAC units is approximately 1050€/unit, while the average cost of purchasing a CAC system is approximately 43283€/unit. The mean installation costs and the Operation and Maintenance (O&M) costs for RACs and CACs are shown in Table 3 and Table 4, respectively. The results show that the average installation cost for RACs is 230€/kW, and for CACs is approximately 300 €/kW. The average O&M cost for split systems is 55€/unit/year, while the average O&M cost for CACs is approximately 1850 55€/unit/year. The indicated O&M costs don't include energy costs.
- **Typical applications:** VC is the dominant cooling technology for SC as well as PC applications. Nearly 99% of Europe's cooling demand is covered by VC technologies [13,29,49,48].
- **Development trends:** there are a number of R&D efforts for VC technologies carried out by public and private institutions: among others, a number of the most important ones are: energy efficiency increase, deployment of environmentally friendly refrigerants, miniaturized mechanical VC refrigeration systems, small-scale cooling devices, etc. [13,29,42,49,48].

3.3. Alternative space cooling systems

This section is thoroughly describing the major characteristics of the alternative SC systems by explaining shortly the physical principle of each technology and the technical parameters such as fuel type used, cold source, reference sink temperature, resource usage, range of available size per type of the system, and efficiency level (COP, EER, SEER, SPF, etc.). The efficiency levels of VC systems are typically assessed and rated under specific regulations and standards. These regulations and standards provide a framework for measuring and comparing the performance of VC systems, and they often include requirements for testing procedures, equipment specifications, and energy efficiency metrics. However, this is not yet the case for alternative SC technologies, which may not have established regulations or standards

for assessing their efficiency levels.

Table 5 shows the energy efficiency of the various technologies using conventional VC's efficiency as a benchmark. It can be seen that only 11 technologies have higher foreseen efficiencies than conventional VC systems' actual efficiency as follows: thermionic, thermotunnel, electrocaloric, electrochemical, Lorenz-Meutzner cycle (blends only), Turbo-Compressor-Condenser-Expander HP, elastocaloric effect, membrane HP, magnetocaloric effect, ground-coupled solid desiccant system and evaporative liquid desiccant system.

In addition to the efficiency level, this section investigates the TRL for the alternative SC technologies, as shown in Fig. 4, which indicates only the TRL of the alternative systems to be compared with the conventional VC systems that have TRL up to 9. In order for cooling technology to compete in the market in the near future, a TRL between 5 and 9 is defined as the most promising baseline. Only ten technologies have a TRL level between 5 and 9 as follows: absorption cycles, adsorption cycles, reverse Brayton cycle, membrane HP, enthalpy recovery, transcritical cycle, natural convection, natural conduction, freeze/melt cycle and evaporative cooling. Most of the other technologies have a TRL level between 3 and 4 as they are in the state of the lab test or either lab prototype. Few technologies have a TRL level of 2 in the formulation phase for the technology concept, such as thermionic emission, thermotunnel, electrocaloric effect and heat of reaction.

The technology costs are also presented in Table 5, using the conventional VC systems' costs as a baseline. It can be seen that there are no technologies with lower costs than conventional VC systems. The costs for most of the technologies are either not identified or equal to VC costs by assumption based on the previous references. Transcritical cycle, stand-alone solid desiccant system, stand-alone liquid desiccant system, ground-coupled solid desiccant system, absorption/adsorption cycles, and transcritical Thermal Compression HP have higher costs than VC systems.

In the present taxonomy, thermoelectric, thermionic, thermotunnel, electrocaloric, and electrochemical technologies are grouped under the electrical form of energy input, so all these cooling devices are powered by electricity. In addition to that, they use air as a cold source.

3.3.1. Thermoelectric

Thermoelectric cooling is based on the Peltier effect. A Peltier cooler is composed of semiconductor materials, typically made from bismuth telluride or other similar compounds. When an electric current is passed through the junction of two different semiconductors, a temperature differential arises. As one junction warms up, the other one gets cooler. The cool side drops below room temperature while the warm side is kept at ambient temperature by being connected to a heat sink. The heat sink can also be a coolant fluid which is cooled down by the ambient temperature. During the cooling process, the heat transfer medium of thermoelectric cooling devices does not change phases (single phase (solid)).

- **Reference sink temperature:** for most thermoelectric applications, Normal heat sink temperature rise above ambient (or cooling fluid) is between 5 and 15 °C.
- **Resource usage:** no liquid refrigerant.
- **Energy efficiency:** the maximum theoretical second law efficiency of current status quo materials of thermoelectric cooling systems is around 0.18, which is considerably lower than the second law efficiency of 0.50 achieved by today's VC technologies [15,53].
- **Range of capacity installed:** small-size applications and installed capacities of up to a few hundred watts [36].
- **Typical applications:** portable refrigerators, car seat air-conditioning, wine cabinets, and spot cooling for electronics are a few examples of typical applications for such technology [36].
- **Development trends:** research will likely make the efficiency of thermoelectric cooling devices and VC close in local comfort applications such as cooled seats [36].

3.3.2. Thermionic

In thermionic cooling, energetic electrons emit from the surface of the cathode to remove heat and allow the cathode to cool. Thermionic cooling devices' heat transfer medium doesn't change phases during the cooling operation (single phase (solid)).

- **Reference sink temperature:** moderate heat sink temperatures, around 20 °C, are typical of thermionic devices.
- **Resource usage:** no liquid refrigerant.
- **Energy efficiency:** ideally, it is possible for a thermionic technology efficiency to approach the Carnot efficiency [54]. Moreover, assumptions indicate that thermionic cooling modules could achieve 50–55% of the Carnot efficiency [36].
- **Range of capacity installed:** very low capacities, for instance, between 50 and 500 W.
- **Typical applications:** this technology can be applied to all cooling applications in residential and commercial buildings in different climate regions.
- **Development trends:** although research continues to focus on this technology, particularly on new materials for embedded applications [55], it remains subject to numerous challenges that limit the development of thermionic cooling.

3.3.3. Thermotunnel (thermotunneling)

Thermotunnel cooling is comparable to thermionic emission cooling (also known as thermotunneling). The difference is that in thermotunnel cooling, electrons do not move back to the emission point due to voltage difference. The heat transfer medium of thermotunnel cooling devices does not undergo a phase change during the cooling process too (single phase (solid)).

- **Reference sink temperature:** the same sink temperature of thermionic cooling [assumed].
- **Resource usage:** no liquid refrigerant (same as thermoelectric).
- **Energy efficiency:** the expected efficiency is 55% of Carnot, the same as thermionic systems, as opposed to 40–45% of Carnot for typical VC systems in HVAC applications [36].
- **Range of capacity installed:** very low capacities [30].
- **Typical applications:** same as thermoelectric, technically, it can be applied to all cooling applications for residential and commercial buildings. Thermotunneling cooling devices are currently being developed for small electronics cooling applications.
- **Development trends:** there are still numerous challenging issues that need to be overcome, as seen by the limited prototype development. Technology's future development trends are average.

3.3.4. Electrocaloric

According to the electrocaloric refrigeration theory, materials are imposed on an electric field. By modifying the dipolar state of the material, which in turn leads to a change in entropy and a consequent increase in temperature, the material is made to release heat in response to the applied electrical field [52]. There is no working fluid in the electrocaloric systems. The fluid is only a heat carrier but does not undergo any phase change during the cooling process. It is the solid refrigerant (caloric material) that undergoes a solid-solid phase change.

- **Reference sink temperature:** relatively low sink temperatures, such as around 20 °C.
- **Resource usage:** no liquid refrigerant.
- **Energy efficiency:** electrocaloric cooling instruments are characterized by relatively high (projected) energy efficiency values, such as projected COPs ranging from 3.7 to 4.9. These projected COPs are 16–53% higher than the overall system COP of baseline air-conditioners [36].

- **Range of capacity installed:** the capacities of electrocaloric cooling systems are too small for cooling and refrigeration applications, with few watts of up to 2 kW [52].
- **Typical applications:** it can be applied to all cooling applications
- **Development trends:** R&D is currently focusing on manufacturing electrocaloric materials and electrodes. However, the technology is still being developed for HVAC and other cooling applications in buildings.

3.3.5. Electrochemical

An electrochemical cell, for cooling purposes, compresses a hydrogen working fluid using a proton exchange membrane to drive a VC or metal hydride HP cycle. During the cooling process, the heat transfer medium in electrochemical cooling devices does not change phase (single phase (gaseous)).

- **Reference sink temperature:** electrochemical cooling devices are characterized by moderate sink temperatures, such as 35 °C [56].
- **Resource usage:** hydrogen/refrigerant [30].
- **Energy efficiency:** current efforts focus on developing room air-conditioners with a COP higher than 4 [30].
- **Range of capacity installed:** small power applications, such as 1 kW [57].
- **Typical applications:** development of a new product has initially prioritized packaged air-conditioning systems.
- **Development trends:** for the technology to be commercialized, extensive R&D is required to better understand its potential energy savings and cost-effectiveness.

The alternative VC systems (Lorenz-Meutzner cycle, transcritical cycle, S-RAM, Turbo-Compressor-Condenser-Expander HP), no phase change (Stirling/Ericsson cycles, reverse Brayton, Bernoulli cycle, elastocaloric effect, barocaloric effect), and phase change ((Metastable) critical flow cycle, Membrane HP) technologies comprise the second group of cooling technologies (mechanical energy) as shown in Fig. 2. These technologies are driven by electricity except for Stirling/Ericsson cycles which are driven by thermal energy sources such as natural gas, gasoline, wood, waste heat or high-temperature heat sources. Additionally, they use air as a cold source.

3.3.6. Lorenz-Meutzner cycle (blends only)

The working fluid for the Lorenz-Meutzner cycle is a zeotropic mixture that has a gliding temperature differential during the evaporation and condensation phases [58]. These devices are electrically driven. There is very little data or information available on this technology since it is not currently on the market. Therefore, not much information regarding capacities, applications and development trends.

- **Reference sink temperature:** the condenser air inlet temperature in the cycle is about 32 °C [59].
- **Resource usage:** refrigerant.
- **Energy efficiency:** the Lorenz-Meutzner cycle has shown advantages and achieved 20% energy savings compared to standard refrigerators. Therefore the efficiency is projected to be higher than traditional VC systems [51].
- **Range of capacity installed:** large capacity [60].
- **Typical applications:** large systems such as domestic refrigerator-freezer [60].
- **Development trends:** this technology is only studied in the laboratory, but prototypes are in the development stages [60].

3.3.7. Transcritical cycle

The CO₂ transcritical cycle was proposed to reduce the global warming impact of HFC-based air-conditioning and refrigeration systems. Transcritical systems maintain CO₂ above the critical temperature by cooling it at the gas cooler's inlet without allowing it to condense.

Table 7

Desiccant cooling systems characteristics.

System	Reference sink temperature	Range of capacity installed	Energy efficiency values
Evaporative liquid desiccant	20–50 °C [93]	moderate capacities of about 35 kW [36]	COPs range from approximately 0.2–1.3 [93]
Ground-coupled solid desiccant	16–21 °C [94]	small capacities about 1 kW [36]	a COP ranging between 9.6 and 16.3 [95]
Stand-alone liquid desiccant	regeneration temperature of 60–75 °C [96]	small capacities of about 1.7–5.5 kW [96]	a COP ranging between 4.8 and 5.5 [97]
Stand-alone solid desiccant	high regeneration temperature (up to 170 °C) [98]	moderate capacities of about 10 kW [99]	COPs less than 1 [100]

Table 8

Natural cooling systems characteristics.

System	Resource usage	Typical applications
Natural Convection (heat exchanger – mixing)	air	residential and tertiary sectors
Natural conduction (heat exchanger)	water	residential and tertiary sectors (water loops cooling the ambient via an air-to-water heat exchanger)
Freeze/melt cycle (latent cold storage)	air	residential and tertiary sectors
Evaporative cooling (water evaporation)	water	residential and commercial buildings in hot-dry climate regions
Enthalpy recovery (heat exchanger)	air	offices and education buildings
Sky radiative cooling	air	residential and tertiary sectors

- **Reference sink temperature:** a heat sink temperature of up to 90 °C.
- **Resource usage:** refrigerant.
- **Energy efficiency:** the efficiency is unknown at this time.
- **Range of capacity installed:** 6–12 kW for optimal working conditions [61].
- **Typical applications:** centralized commercial systems [62].
- **Development trends:** for the next 20 years, it is anticipated that research interest in the transcritical CO₂ cycle will remain high, with a potential for large-scale commercial applications.

3.3.8. Sanderson rocker arm mechanism

This cooling technology uses a unique rocker arm design to transfer heat from the engine to the cooling system, allowing for more efficient cooling and improved performance. It works by using a rocker arm to connect two or more pipes. When the temperature in the space increases, the rocker arm expands, allowing the air to flow freely through the pipes. When the temperature in the space decreases, the rocker arm contracts, restricting the flow of air. By controlling the flow of air in this way, the space can be cooled when necessary. The heat transfer medium of the system does not change phases (single phase (gaseous)).

- **Reference sink temperature:** the temperature of the cooling airflow intake is 48.9 °C [63].
- **Resource usage:** refrigerant.
- **Energy efficiency:** the efficiency is unknown at this time.
- **Range of capacity installed:** in heat pump and cooling applications with capacities ranging from 25 to 300 kW [64].
- **Typical applications:** this technology is intended for use in packed rooftop units for commercial buildings [30].

- **Development trends:** S-RAM cooling technology has seen a number of advancements in recent years. Many of these advancements have focused on improvements in the cooling efficiency of the mechanism. At the moment, the core S-RAM compressor is being tested with heat exchangers, and new designs are being developed to increase the efficiency and reduce the size of the heat exchangers [30,65].

3.3.9. Turbo-compressor-condenser-expander heat pump

Turbo-compressor-condenser-expander HP uses a turbine-compressor to compress the refrigerant, a condenser to reject heat to the environment, and an expander to expand the refrigerant and absorb heat from a low-temperature source. The heat transfer medium of the system does not change phases (single phase (gaseous)).

- **Reference sink temperature:** the reference sink temperatures range from 55 to 65 °C [66].
- **Resource usage:** refrigerant.
- **Energy efficiency:** the performance of the current design is estimated at a SEER of 20 in residential buildings compared to a SEER of 14 as a baseline [30].
- **Range of capacity installed:** in heat pump and cooling applications with capacities ranging above 150 kW [66].
- **Typical applications:** air-cooled packaged units in commercial buildings.
- **Development trends:** it is expected that this technique will continue to be uncompetitive with vapour compression in the near future since prototypes are still in the development stage and further research and development have to be done.

3.3.10. Stirling/Ericsson cycles

The following technologies have been assigned to Stirling/Ericsson cycles since they have the same principles. The technical characteristics of the cycles are described below in Table 6. The heat transfer medium of the system does not change phases (no-phase change (gaseous)).

3.3.10.1. Reverse Stirling. The reverse Stirling cycle is a thermodynamic cycle involving a heat engine that is based on the Stirling cycle but operates in reverse [74].

3.3.10.2. Duplex Stirling. The duplex Stirling machine (or duplex Stirling HP) utilizes a gas-fired Stirling engine's mechanical energy to compress and expand a gaseous refrigerant while transferring it between two chambers [75].

3.3.10.3. Vuilleumier HP. A Vuilleumier HP produces a warm and a cold side by cyclically compressing and expanding a gaseous working fluid (typically high-pressure helium) using a gas-fired heat engine [36].

Reverse Ericsson

- **Resource usage:** refrigerant.
- **Energy efficiency:** reverse Stirling and duplex Stirling cycles are characterized by low energy efficiency levels – the estimated COP is approximately 1 [11,36]. Vuilleumier HP has an estimated COP of 0.8 [36]. Reverse Ericsson cycle has a second-law efficiency of approximately 3% [73].
- **Typical applications:** reverse Stirling devices are used for cooling electronic sensors and microprocessors. Duplex Stirling devices are available for applications for cryocooling, low-temperature and niche refrigeration. Vuilleumier HP would be appropriate for most of the applications in residential and commercial buildings. Reverse Ericsson devices are used for refrigeration and air-conditioning.

- **Development trends:** the different Stirling/Ericsson cycles are currently under development for the different HVAC applications.

3.3.11. Reverse Brayton (Bell Coleman cycle)

Reverse Brayton (Bell Coleman cycle) is a modified version of the Brayton cycle, which is an ideal thermodynamic cycle used to describe the operation of a gas turbine engine. The reverse Brayton cycle allows for heat rejection at a lower temperature than in a traditional Brayton cycle, improving the system's efficiency. The heat transfer medium of the system does not change phases (no-phase change (gaseous)).

- **Reference sink temperature:** moderate inlet temperatures such as around 20 °C [76].
- **Resource usage:** refrigerant.
- **Energy efficiency:** reverse Brayton cycles have a COP range between 0.5 and 0.8 [36].
- **Range of capacity installed:** can reach large capacities such as nearly 90 MW.
- **Typical applications:** transportation space condition, commercial and industrial refrigeration.
- **Development trends:** recent trends in the development of the reverse Brayton cycle have focused on increasing its efficiency and reducing its cost in different applications, such as food freezing applications [77].

3.3.12. Bernoulli cycle

The Bernoulli cycle cooling system uses the principles of the Bernoulli equation to transfer heat. The cycle produces cooling across the nozzle throat by accelerating a working fluid through a converging-diverging nozzle. The heat transfer medium of the system does not change phases (no-phase change (gaseous)).

- **Reference sink temperature:** relatively low temperature, cooler than the indoor temperature
- **Resource usage:** refrigerant.
- **Energy efficiency:** current prototypes have very low COPs (around 0.1) but are expected to improve in the near future (COPs of 2–3) [36].
- **Range of capacity installed:** relatively small capacities (e.g. 5 W) [36].
- **Typical applications:** for the majority of vapour compression cooling applications, the Bernoulli HP would be appropriate (split systems and packaged units).
- **Development trends:** Bernoulli HP is a developing technology. Although the COP of the current prototypes is quite low, it is anticipated to increase.

3.3.13. Elastocaloric effect

In elastocaloric refrigeration, pressure is exposed to the elastocaloric materials, which may be done by compression, tension, bending, or torsion [52]. The elastocaloric effect is a cooling technology that utilizes the change in temperature of a material when it is subjected to mechanical stress. When an elastocaloric material is stretched, it absorbs heat and cools down, while when it is released from the stress, it releases heat and heats up [78]. The same as electrocaloric systems, there is no working fluid in the elastocaloric systems. The fluid is only a heat carrier but does not undergo any phase change during the cooling process.

- **Reference sink temperature:** near the room temperature [79].
- **Resource usage:** water [52,79].
- **Energy efficiency:** elastocaloric effect has high COPs that could be higher than 9 [52].
- **Range of capacity installed:** small capacities below 1 kW [52,80].
- **Typical applications:** domestic cooling devices since the effect can be applied to various cooling applications in residential and commercial buildings.

- **Development trends:** several laboratory prototypes are currently being developed [30].

3.3.14. Barocaloric effect

Adiabatic compression, heat transfer (from a cold to a hot heat exchanger), decompression, and heat transfer (from a hot to cold heat exchanger) are the four key processes of the barocaloric refrigeration cycle. The barocaloric effect utilizes the change in temperature of a material when it is subjected to pressure. When a barocaloric material is compressed, it heats up and releases heat, while when it is released from the pressure, it cools down and absorbs heat [81]. The same as electrocaloric systems and elastocaloric systems, there is no working fluid in the barocaloric systems. The fluid is only a heat carrier but does not undergo any phase change during the cooling process.

- **Reference sink temperature:** near the room temperature [79].
- **Resource usage:** water [52,79].
- **Energy efficiency:** barocaloric effect has a high COP value of 6 [52].
- **Range of capacity installed:** few watts for modelling [52].
- **Typical applications:** cryocoolers
- **Development trends:** early stage for developing materials and cycles [52].

3.3.15. (Metastable) critical flow cycle

Using a converging-diverging nozzle, the critical-flow refrigeration cycle provides SC by expanding a liquid refrigerant and absorbing heat from a secondary fluid. The working fluid of critical flow cycle cooling devices undergoes a phase change during the cooling process (two-phase). The mediums used are liquid/gaseous.

- **Reference sink temperature:** critical flow cycle devices are characterized by moderate sink temperatures, such as 35 °C [82].
- **Resource usage:** refrigerant.
- **Energy efficiency:** laboratory prototypes have an estimated COP of 1.7. Additionally, researchers found that the COP of the system can be improved up to 15 [30,36].
- **Range of capacity installed:** such technologies have a moderate installed capacity of up to 15 kW [83].
- **Typical applications:** due to the need for a secondary working fluid in order for the nozzle assembly to transfer heat, large commercial chillers are one of the most promising applications.
- **Development trends:** recent advancements show promising developments for commercial HVAC applications.

3.3.16. Membrane heat pump

A membrane HP uses a vacuum pump to transfer moisture across a number of membranes to provide cooling and dehumidification. The working fluid of membrane HPs undergoes a phase change during the cooling process (two-phase). The mediums used are liquid.

- **Reference sink temperature:** an inlet temperature of 35 °C [84].
- **Resource usage:** water.
- **Energy efficiency:** researchers claim that EER could be twice that of VC systems, resulting in energy savings of 50%, with an estimated SEER of 30 [30].
- **Range of capacity installed:** moderate cooling capacities, such as from 4 to 30 kW [85].
- **Typical applications:** a promising technology for improving the comfort and efficiency of commercial buildings through the separation of the air-conditioning process into sensible heat cooling and dehumidification [86].
- **Development trends:** in comparison to VC systems for SC, membrane-based heat pump systems have caught the interest of several research teams as a possibly more environmentally friendly technology with the development of several prototypes [87].

3.3.17. Thermoacoustic

Thermoacoustic cooling works by transforming acoustic energy into thermal energy. The presence of acoustic waves (standing or travelling) expands, and they can be either standing waves or travelling waves. The technology is driven by waste heat, solar heat or other heat. The working fluid of thermoacoustic cooling devices also does not undergo a phase change during the cooling process (single phase). The mediums utilized (e.g. helium, argon, air) are gaseous.

- **Reference sink temperature:** relatively low inlet temperatures, for example, 25–35 °C [88].
- **Resource usage:** refrigerant.
- **Energy efficiency:** the maximum theoretical efficiency of VC technology is higher than that of thermoacoustic technology [36].
- **Range of capacity installed:** relatively low capacities, about 3.5 kW [36].
- **Typical applications:** applications like portable air-conditioners.
- **Development trends:** development of commercial supermarket chillers [36].

3.3.18. Magnetocaloric effect

The magnetocaloric effect, which exposes paramagnetic materials to a magnetic field, is the basis for magnetic cooling. For the vast majority of magnetocaloric materials, heating and cooling are caused by magnetization and demagnetization, respectively [52,89]. There is no working fluid in the magnetocaloric systems. The fluid is only a heat carrier but does not undergo any phase change during the cooling process. The mediums utilized (e.g. gadolinium) are solid.

- **Reference sink temperature:** relatively moderate sink temperatures, such as 25 °C [36].
- **Resource usage:** refrigerant.
- **Energy efficiency:** depending on the conditions, the COP varied from 0.2 to 9.4 during the test [52].
- **Range of capacity installed:** relatively low capacities such as 500 W to 3.5 kW [30].
- **Typical applications:** mobile refrigerators, medical and commercial [30,52].
- **Development trends:** R&D focuses on magnetocaloric materials and system design optimization [52].

3.3.19. Desiccant cooling systems

In desiccant cooling systems, desiccants remove water from entering airstreams, which are then cooled by air-conditioners or evaporative coolers. The working fluid of desiccant cooling instruments undergoes a phase change during the cooling process. The mediums utilized are liquid or solid (according to the different systems as described below). Desiccant cooling systems are driven by natural gas, solar heat or waste heat.

- 3.3.19.1. **Evaporative liquid desiccant system.** The combination of evaporative cooling with liquid desiccants is known as evaporative liquid desiccant technology. The system typically consists of a liquid desiccant solution that is circulated through a regenerator, where it is heated and regenerated, and a dehumidifier, where it removes moisture from the air [90]. The mediums utilized are liquid.
- 3.3.19.2. **Ground-coupled solid desiccant system.** Ground-coupled fluid systems and solid desiccants are combined in the ground-coupled solid desiccant technology. They utilize the principle of desiccant dehumidification to remove moisture from the air, followed by heat exchange with the ground to cool the air. The mediums utilized are liquid.
- 3.3.19.3. **Stand-alone liquid desiccant system.** In stand-alone liquid desiccant systems, moisture from the air is absorbed using liquid desiccant materials having a strong affinity for water

[23]. The mediums utilized are liquid. Compared to solid desiccants, liquid desiccants provide a number of benefits. Since liquid desiccants often have fewer pressure drops, they can be used with low-temperature regeneration [23,91].

3.3.19.4. Stand-alone solid desiccant system. Stand-alone solid desiccant systems also absorb moisture from the air using solid desiccant materials with a high affinity for water. The mediums utilized are solid.

The technical characteristics of the different desiccant cooling systems are described below in Table 7.

- **Resource usage:** water.
- **Typical applications:** with the exception of ground-coupled solid desiccant systems and stand-alone liquid desiccant systems, which are only applicable in hot-humid climate zones, all desiccant cooling systems are applicable to all applications for all building types and climate areas [36].
- **Development trends:** for the next two decades, desiccant cooling systems will not have a high market penetration [15]. Even if evaporative liquid desiccant systems have developed, they have not yet been commercialized, while several institutions are working to develop advanced products for stand-alone liquid desiccant systems [36]. Conventional solid desiccants are still struggling to achieve acceptable cooling performance [92]. The ground-coupled solid desiccant system has been considered a “moderately promising” technology by the DOE and has not yet achieved market penetration [36].

3.3.20. Heat of reaction

Cooling through a chemical process occurs through an endothermic reaction at which heat (energy) is taken in, followed by a drop in temperature. In this case, a reaction (e.g. of two chemical substances) takes in energy from the starting point until the end. The working fluid at chemical cooling does not undergo a phase change during the cooling process (single phase). The mediums utilized are solid/liquid.

- **Reference sink temperature:** moderate inlet temperature levels such as about 30 °C [101].
- **Resource usage:** refrigerant (e.g. sodium nitrate or H₂O).
- **Energy efficiency:** the efficiency is unknown at this time.
- **Range of capacity installed:** low capacities of up to a few hundred watts.
- **Typical applications:** very small applications such as portable electronic device heat management [9].
- **Development trends:** even though this technology has interested some industries [102], its development trend appears to be limited.

3.3.21. Absorption and adsorption cycles

Similar in operation to the VC refrigeration cycle, the key distinction between absorption and adsorption cooling systems is that thermal energy, rather than mechanical work, drives the cycle. Water/ammonia and lithium bromide/water are typical working fluids (sorbent/refrigerant) for absorption systems, and metal chlorides/ammonia, zeolite/water, activated carbon/methanol, zeolite/water, activated carbon/ammonia, silica gel/water, or composite adsorbents for adsorption systems. Sorption cooling systems are driven by natural gas, solar thermal, process steam or waste heat steam.

- **Reference source temperature:** inlet temperatures between 70 and 100 °C and higher [36].
- **Resource usage:** refrigerant.
- **Energy efficiency:** COPs range from approximately 0.4–1.2 depending on the cycle configuration [103,104].
- **Range of capacity installed:** available in a range of capacities ranging from 4.5 kW to 30 MW [23,105,106].

- **Typical applications:** applicable for SC solutions for both residential and commercial buildings.

- **Development trends:** the use of such technology is being expanded through a number of initiatives, including the development of environmentally benign refrigerant pairs, improved energy efficiency, decreased cost, and scaled-down size [36].

3.3.22. Transcritical thermal compression heat pump

Transcritical thermal compression HP is a new technology developed by boostHEAT company driven by gas. It includes a thermal compressor that uses the heat produced by the combustion of gas not to heat water directly (for example) but to activate a heat pump cycle. It operates using an external point heat source to compress CO₂.

- **Reference sink temperature:** high temperature of 700 °C [107, 108].
- **Resource usage:** refrigerant.
- **Energy efficiency:** the COP is approximately 2 [107].
- **Range of capacity installed:** relatively moderate capacities such as about 17–50 kW [107].
- **Typical applications:** can be used in SC applications in residential and commercial sectors [108].
- **Development trends:** average development trend for a wider range of applications, including residential and commercial buildings.

3.3.23. Natural cooling

Natural cooling systems that utilize sensible heat refer to certain building designs that make an effort to include physical concepts (such as reflection) into the building’s envelope in order to reduce the rate of heat transfer into buildings (particularly from the sun). In contrast, natural cooling systems working with latent heat refer to certain building designs which attempt to integrate physical principles (e.g. evaporation) into the building’s envelope to remove heat from buildings. Natural cooling solutions can be passive or active cooling technologies.

3.3.23.1 Natural convection (heat exchanger – mixing). Natural convection occurs in natural cooling systems that use gaseous refrigerants (e.g. cold air) and working fluid that does not undergo a phase transition (single phase). The technology can be an active/passive system.

3.3.23.2 Natural conduction (heat exchanger). Natural conduction occurs in natural cooling systems that use liquid refrigerants (e.g. cold water) and working fluid that does not undergo a phase transition (single phase). The technology can be an active/passive system.

3.3.23.3 Freeze/melt cycle (latent cold storage). The freeze/melt cycle occurs in natural cooling systems that use solid/liquid refrigerants (e.g. melting ice) and working fluid that undergoes a phase change (two-phase). In a typical freeze/melt cycle system, water or another suitable phase change material (PCM) is used as the storage medium. The technology can be an active/passive system.

Evaporative cooling (water evaporation). At natural cooling systems where the working fluid undergoes a phase change (two-phase) and liquid/vapour refrigerants (e.g. water/water vapour) are used, the process uses large heat sorption due to evaporation of water. The technology is an active system.

3.3.23.5 Enthalpy recovery (heat exchanger). The integrated heat and moisture exchange panels are used in this technique. A modular energy recovery ventilator panel is used to provide preconditioned outside air directly to a room by installing it in the building envelope. The working fluid does not undergo any phase change during the cooling process. This technology is an active system.

3.3.23.6 Sky radiative cooling. According to the SC taxonomy, sky radiative cooling is the only completely passive solution identified, as shown in Fig. 2. Sky radiative cooling results from the longwave infrared radiation heat transfer between a surface on earth and molecules (primarily water vapour, CO₂ and ozone) at a reduced altitude over the surface [109]. Through the atmospheric window, thermal infrared radiation from an item on earth is sent into the cold universe to cool it by sky radiative cooling.

Additionally, the resource usage and typical applications are shown in Table 8.

- **Reference sink temperature:** N/A
- **Energy efficiency:** N/A
- **Range of capacity installed:** N/A
- **Development trends:** due to natural cooling systems being available for decades on the market but having achieved quite a low market penetration so far as well as R&D efforts are still needed.

4. Discussion

4.1. Findings and recommendations

SC technologies have become increasingly important as the world looks for different ways to reduce energy consumption and decrease the effects of climate change and global warming. The aforementioned technologies have the potential to significantly improve energy efficiency and reduce environmental impact. Additionally, the study also identified a trend towards dependence on non-renewable energy sources in SC technologies and reducing greenhouse gas emissions.

The parameters used to categorize the alternative SC technologies in this study were chosen to provide a comprehensive understanding of the characteristics and potential of each technology. This information can be used to identify the most promising technologies for further development and implementation. These parameters include the physical form of energy input, basic working/operating principle, refrigerant or heat transfer medium, phase of the working fluid, specific physical process or device, type of SC technology (active or passive solution), fuel type, and TRL. The physical form of energy input, for example, indicates the type of energy required to drive the technology, while the basic working principle and phase of the working fluid provide insight into the underlying physics of the technology and how it functions. Similarly, the refrigerant or heat transfer medium used in the technology is an important factor in determining its performance and characteristics. The specific physical process or device refers to the technology-specific process or device that is used to cool the air. The type of SC technology refers to whether the solution is active or passive. Finally, the fuel type, in particular, whether it is renewable or not, refers to the type of energy used to drive the technology. Lastly, the TRL was used to indicate the level of maturity of each technology. This parameter provides insight into the potential for each technology to be developed and implemented in the near future.

While alternative SC technologies such as absorption systems, adsorption systems and desiccant systems have the potential to provide energy-efficient cooling, they often cannot compete with conventional VC systems in terms of efficiency and cost in the short-term and medium-term [110]. However, some alternatives such as thermionic, thermo-tunnel, membrane heat pump and evaporative liquid desiccant systems have been shown to be cost-competitive and energy-efficient options in certain applications. Additionally, the development of new technologies such as electrocaloric, electrochemical, Lorenz-Meutzner Cycle (blend only), turbo-compressor-condenser-expander HP, elastocaloric, barocaloric and magnetocaloric is also promising and assumed to be more efficient than traditional VC systems, but still under development and testing phase and have either unknown or not-identified costs as shown

in Table 5.

The long-term competitiveness of alternative SC technologies depends on several factors. First, policy support plays a crucial role in promoting the adoption of sustainable cooling solutions [111]. Governments can implement policies that incentivize the use of energy-efficient and environmentally friendly SC technologies. For example, policies could include financial incentives, regulations, and standards that encourage the deployment of alternative SC systems. These policies can create a favourable market environment, driving investment and research into improving the long-term viability of alternative SC technologies. Second, the urgency to address climate change and reduce greenhouse gas emissions is increasing. Conventional VC systems contribute to CO₂ emissions, and the environmental impact of cooling is a growing concern [112]. As countries strive to achieve their climate goals and transition to more sustainable energy systems, the demand for energy-efficient and low-carbon cooling technologies will likely rise. This increased demand could lead to further advancements and cost reductions in alternative SC technologies.

Among the alternative SC technologies that have the potential to be more efficient than conventional VC systems, Membrane HP stands out as having the highest TRL of 5–6. This means that the Membrane HP has been validated and demonstrated in a relevant environment, proving its effectiveness and reliability. It also means that the technology is at a stage where it is ready for commercialization and has been validated by testing in a relevant environment. Additionally, other technologies that also have high TRL, such as absorption/adsorption cooling systems, reverse Brayton, and enthalpy recovery. However, these technologies either have a very low efficiency or their efficiency has not been identified. Absorption/adsorption cooling systems have a TRL range of 3–9, and they use a heat source to drive a cooling process instead of electricity. However, these systems typically have a lower COP compared to VC systems and are, therefore, less efficient. Reverse Brayton systems have a TRL range of 5–9, and enthalpy recovery systems have a TRL of 7, but their efficiencies are not yet identified.

Lastly, other alternative SC technologies are already commercialized in the market with a TRL of 9, but their efficiencies and costs are mostly not identified. These technologies include the transcritical cycle, natural conduction (heat exchanger), natural convection (heat exchanger – mixing), evaporative cooling (water evaporation) and freeze/melt cycle (latent cold storage). More research is needed to identify the efficiencies and costs for such systems, to have a better understanding of their performance and make them more competitive with VC systems in the market.

It is necessary to acknowledge the uncertainties surrounding the results and findings presented. One of the primary sources of uncertainty lies in the complex interplay between technological advancements and market dynamics. While the paper provides recent insights into the current state of these alternative SC technologies, their future development depends on various factors, including regulatory frameworks, investment patterns and consumer preferences. These factors are subject to change over time, and accurately predicting their evolution is challenging. Furthermore, Predicting market acceptance accurately is inherently challenging, as it involves understanding and forecasting the behaviour and preferences of diverse actors within complex socio-technical systems [113]. To enhance the robustness and validity of the findings, future research should consider integrating uncertainty modelling approaches. By incorporating probabilistic or scenario-based analyses, researchers can provide better approaches to the potential future outcomes and highlight the range of possibilities.

4.2. Strength and limitations

The first strength of the paper relies on the comprehensive analysis of a wide range of SC technologies, using multiple well-defined parameters to categorize and evaluate each technology. Another strength of the paper is based on providing a realistic assessment of the potential for

each technology to be developed and implemented by using TRL as a parameter to evaluate the maturity of each technology. The third strength of the paper is identifying several alternative SC technologies with the potential to provide energy-efficient cooling, such as membrane heat pumps, thermionic systems, thermotunnel systems, and evaporative liquid desiccant systems. The fourth strength of the study is identifying trends towards reducing greenhouse gas emissions in SC technologies, which is important for addressing climate change and promoting sustainability.

However, the study has some limitations. The scientific literature is rich in research and investigation on both the heating sector and conventional VC cooling technologies but relatively little on alternative SC technologies. There is still a significant gap in the knowledge about these systems compared to the VC and heating technologies, despite the increasing interest in developing alternative SC technologies. The fact that some of these technologies are still in the early stage of development or have not yet attained a large market share is one of the main reasons for the lack of knowledge on alternative SC technologies. This makes it difficult to determine the cost of these systems using VC technology as a baseline.

Furthermore, since a number of these systems are still undergoing research and development, the costs and efficiencies of these systems are not yet known. For instance, the only competing SC technology with a sizable market share is TDHP, although even in this instance, the information is limited. The other alternative SC technologies have limited information available in the scientific literature, as shown in Table 5. To make these systems more competitive in the market, further study is required to more accurately analyze the potential performance and anticipated costs of these systems.

Lastly, it should be acknowledged that the exclusive reliance on a qualitative approach to analyze the performance of different technologies. This limitation arises from the nature of the study, which aimed to synthesize existing literature and provide a comprehensive overview of the topic at hand. The use of a qualitative approach allowed for a deep understanding of the technologies and their impact, but it may not provide a practical understanding or quantitative assessment of their performance.

4.3. Implication on practice and future research

The field of alternative SC technologies offers promising perspectives for reducing energy consumption, minimizing environmental impact, and addressing the challenges posed by climate change and global warming [114]. The findings of this study have significant implications for both practice and future research. The study highlights that more experimental investigations and field experiments should be carried out in order to close the information gap about various SC technologies. The study also emphasizes that there is still a lack of information about alternative SC technologies compared to VC and heating technologies. This is due to the fact that some of these technologies are still under development or have not yet attained a sizable market share. To bridge the knowledge gap in this research area and provide guidance for future investigations, a roadmap outlining approaches for filling these gaps can be proposed.

- Novel materials play a crucial role in the development of alternative SC technologies. Research should focus on exploring and evaluating materials with enhanced cooling capabilities, high emissivity, and low solar absorptivity [115].
- System integration and optimization are key aspects that should be addressed in future research. It is essential to develop innovative approaches for integrating alternative SC technologies into existing building systems or designing new systems that maximize energy efficiency. This includes exploring optimal control strategies, developing smart and adaptive cooling systems, and considering the interaction between cooling technologies and other building

systems, such as ventilation and energy storage. Additionally, optimizing the sizing and configuration of cooling systems can help achieve better performance and energy savings.

- Hybrid systems offer significant potential for improving the overall efficiency and performance of alternative SC technologies. By combining multiple cooling technologies, such as membrane heat pumps and evaporative liquid desiccant systems, researchers can leverage the strengths of each technology and achieve higher energy efficiency. Future studies should focus on the design, optimization, and integration of hybrid systems, considering factors such as compatibility, control strategies, and cost-effectiveness.
- To further understand these systems' performance and make them more competitive with VC systems on the market, additional quantitative research is required to determine their costs and efficiency. This includes conducting experimental investigations, field experiments, and quantitative studies to assess the potential benefits, performance, and economic viability of these technologies.
- It is recommended to incorporate scenario analysis as a complementary methodology in future studies. By combining the qualitative approach used in the current study with scenario analysis, researchers can enhance the practical understanding of technology performance and its implications. This methodology could involve developing realistic scenarios that reflect real-world conditions and evaluating the performance of different technologies within those scenarios. The scenarios could consider factors such as user requirements, environmental conditions, and technological constraints.

This study is an integral part of the ongoing LIFE21-CET-COOLING-CoolLIFE project. This project aims to comprehensively address various aspects of SC technologies, including both active and passive SC measures. Furthermore, the project undertakes an in-depth investigation into the economic, policy, social, and cultural dimensions that can significantly impact the market acceptance of these technologies. In addition to these crucial factors, the project also emphasizes the examination of the policy landscape surrounding SC technologies, as well as the social dynamics associated with their adoption. Moreover, the project recognizes the importance of considering the environmental implications and health risks associated with these technologies. By actively incorporating these dimensions into our study, we strive to provide a comprehensive understanding of the factors influencing the market acceptance of SC technologies.

5. Conclusion

The study analyzed a wide range of alternative SC technologies to provide a comprehensive understanding of the characteristics and potential of each technology. In total, the study assessed 32 alternative SC technologies based on eight parameters (the physical form of energy, basic working principle, refrigerant/heat transfer medium, phase of the working fluid, specific physical process/device, type of SC technology (active, passive or both), fuel (fuel type used to drive the SC technology, the possibility to be driven by renewable energy source) and TRL).

The findings of the study found that while a number of alternative SC technologies have the potential to provide energy-efficient SC, they often cannot compete with conventional VC systems in terms of efficiency and cost. However, specific alternatives such as membrane heat pumps, thermionic systems, thermotunnel systems, and evaporative liquid desiccant systems have been shown to be cost-competitive and energy-efficient options in certain applications. The development of new technologies such as electrocaloric, electrochemical, Lorenz-Meutzner Cycle (blend only), turbo-compressor-condenser-expander HP, elastocaloric, barocaloric, and magnetocaloric is also promising and assumed to be more efficient than traditional VC systems, but they are still under development and testing phase, and their costs are either unknown or not identified. The study recommended that more research is needed to

identify the efficiencies and costs of these alternative SC technologies to better understand their performance and make them more competitive with VC systems in the market. The findings also indicated a trend towards reducing greenhouse gas emissions and dependence on non-renewable energy sources in SC technologies, which is essential for addressing climate change and promoting sustainability.

Funding

We are thankful to the LIFE21-CET-COOLING-CoolLIFE project (Grant Agreement number 101075405), for funding the work.

Declaration of competing interest

The authors declare that they have no known competing financial interests or personal relationships that could have appeared to influence the work reported in this paper.

Data availability

No data was used for the research described in the article.

Acknowledgements

The authors thank the Department of Innovation, Research and University of the Autonomous Province of Bozen/Bolzano for covering the Open Access publication costs. The authors also would like to thank Prof. Jim Braun and Dr. Davide Ziviani from Purdue University and Dr. Hicham Johra from Alborg University for reviewing the SC taxonomy provided in the paper.

References

- Atanasiu Bogdan. Principles for nearly zero-energy buildings: paving the way for effective implementation of policy requirements. Brussels, Belgium: BPIE; 2011. <https://www.bpie.eu/publication/principles-for-nearly-zero-energy-buildings/>.
- Elnagar E, Köhler B. Reduction of the energy demand with passive approaches in multifamily nearly zero-energy buildings under different climate conditions. *Front Energy Res* 2020;8. <https://doi.org/10.3389/fenrg.2020.545272>.
- Kalkan N, Young EA, Celiktas A. Solar thermal air conditioning technology reducing the footprint of solar thermal air conditioning. *Renew Sustain Energy Rev* 2012;16:6352–83. <https://doi.org/10.1016/j.rser.2012.07.014>.
- Labban O, Chen T, Ghoniem AF, Lienhard JH, Norford LK. Next-generation HVAC: prospects for and limitations of desiccant and membrane-based dehumidification and cooling. *Appl Energy* 2017;200:330–46. <https://doi.org/10.1016/j.apenergy.2017.05.051>.
- Eurostat, table on EU policy-europe 2020 indicators-headline indicators-climate change and energy-primary energy consumption., (n.d.). https://ec.europa.eu/eurostat/online-help/first-visit/first-visit_en.html#/actions_selection. [Accessed 10 November 2022].
- European Commission, Energy efficiency targets, (n.d.). https://energy.ec.europa.eu/topics/energy-efficiency/energy-efficiency-targets-directive-and-rules/energy-efficiency-targets_en. [Accessed 10 November 2022].
- European Commission, Energy efficiency statistics, (n.d.). https://ec.europa.eu/eurostat/statistics-explained/index.php?title=Energy_efficiency_statistics. [Accessed 10 November 2022].
- Pezzutto S, Fazeli R, De Felice M, Sparber W. Future development of the air-conditioning market in Europe: an outlook until 2020: future development of the AC market in Europe. *WIREs Energy Environ* 2016;5:649–69. <https://doi.org/10.1002/wene.210>.
- Pezzutto S, Toleikyte A, De Felice M. Assessment of the space heating and cooling market in the EU28: a comparison between EU15 and EU13 member states. *Int J Contemp Energy* 2015;1:35–48.
- Pezzutto S, Croce S, Zambotti S, Kranzl L, Novelli A, Zambelli P. Assessment of the space heating and domestic hot water market in Europe—open data and results. *Energies* 2019;12:1760. <https://doi.org/10.3390/en12091760>.
- European Commission, Directorate-General for Energy, Pezzutto S, Novelli A, Zambito A, Quaglino G, Miraglio P, Belleri A, Bottecchia L, Gantioler S, Moser D, Riviere P, Etienne A, Stabat P, Berthou T, Kranzl L, Mascherbauer P, Fallahnejad M, Viegand J, Jensen C, Hummel M, Müller A. Cooling technologies overview and market shares. Part 1 of the study “Renewable cooling under the revised Renewable Energy Directive ENER/C1/2018-493. Publications Office of the European Union; 2022. <https://doi.org/10.2833/799633>.
- EU emissions trading system (EU ETS), (n.d.). https://climate.ec.europa.eu/eu-action/eu-emissions-trading-system-eu-ets_en. [Accessed 14 November 2022].
- Pezzutto S, De Felice M, Fazeli R, Kranzl L, Zambotti S. Status quo of the air-conditioning market in Europe: assessment of the building stock. *Energies* 2017;10:1253. <https://doi.org/10.3390/en10091253>.
- Braungardt S, Bürger V, Zieger J, Kenkmann T. Contribution of renewable cooling to the Renewable Energy Target of the EU; 2018.
- Steven Brown J, Domanski PA. Review of alternative cooling technologies. *Appl Therm Eng* 2014;64:252–62. <https://doi.org/10.1016/j.applthermaleng.2013.12.014>.
- EUROVENT. Statistics data on the HVAC&R market in Europe, Middle-East and Africa, n.d. <https://www.eurovent-marketintelligence.eu/>. [Accessed 11 October 2022].
- Vakiloroyaya V, Samali B, Fakhari A, Pishghadam K. A review of different strategies for HVAC energy saving. *Energy Convers Manag* 2014;77:738–54. <https://doi.org/10.1016/j.enconman.2013.10.023>.
- Commission decision C(2017)7124, technology readiness levels (TRL): horizon 2020—work programme 2014-2015 general. 2020.
- U.S. DoE. DOE G 413.3-4A, Technology Readiness Assessment Guide, <https://www.directives.doe.gov/directives-documents/400-series/0413.3-EGuide-04a>; 2011.
- Zhang C, Kazanci OB, Levinson R, Heiselberg P, Olesen BW, Chiesa G, Sodagar B, Ai Z, Selkowitz S, Zinzi M, Mahdavi A, Teuffl H, Kolokotroni M, Salvati A, Bozonnet E, Chtioui F, Salagnac P, Rahif R, Attia S, Lemort V, Elnagar E, Breesch H, Sengupta A, Wang LL, Qi D, Stern P, Yoon N, Bogatu D-I, Rupp RF, Arghand T, Javed S, Akander J, Hayati A, Cehlin M, Sayadi S, Forghani S, Zhang H, Arens E, Zhang G. Resilient cooling strategies – a critical review and qualitative assessment. *Energy Build* 2021;251:111312. <https://doi.org/10.1016/j.enbuild.2021.111312>.
- Ding G. Recent developments in simulation techniques for vapour-compression refrigeration systems. *Int J Refrig* 2007;30:1119–33. <https://doi.org/10.1016/j.ijrefrig.2007.02.001>.
- Barbosa JR, Ribeiro GB, de Oliveira PA. A state-of-the-art review of compact vapor compression refrigeration systems and their applications. *Heat Tran Eng* 2012;33:356–74. <https://doi.org/10.1080/01457632.2012.613275>.
- Elnagar E, Zeoli A, Rahif R, Attia S, Lemort V. A qualitative assessment of integrated active cooling systems: a review with a focus on system flexibility and climate resilience. *Renew Sustain Energy Rev* 2023;175:113179. <https://doi.org/10.1016/j.rser.2023.113179>.
- Eicker U, Pietruschka D, Haag M, Schmitt A. Systematic design and analysis of solar thermal cooling systems in different climates. *Renew Energy* 2015;80:827–36. <https://doi.org/10.1016/j.renene.2015.02.019>.
- Allouhi A, Kousskou T, Jamil A, Bruel P, Mourad Y, Zeraoui Y. Solar driven cooling systems: an updated review. *Renew Sustain Energy Rev* 2015;44:159–81. <https://doi.org/10.1016/j.rser.2014.12.014>.
- Eicker U, Pietruschka D, Schmitt A, Haag M. Comparison of photovoltaic and solar thermal cooling systems for office buildings in different climates. *Sol Energy* 2015;118:243–55. <https://doi.org/10.1016/j.solener.2015.05.018>.
- Pezzutto S, Quaglino G, Riviere P, Kranzl L, Novelli A, Zambito A, Wilczynski E. Screening of cooling technologies in Europe: alternatives to vapour compression and possible market developments. *Sustainability* 2022;14:2971. <https://doi.org/10.3390/su14052971>.
- Fischer SK, Tomlinson JJ, Hughes PJ. Energy and global warming impacts of not-in-kind and next generation CFC and HCFC alternatives. AFEAS; 1994.
- Goetzler W, Zogg R, Young J, Johnson C. Alternatives to vapor-compression HVAC technology. ASHRAE J 2014;12–23. <https://jfiir.org/en/fridoc/alternativ-es-to-vapor-compression-hvac-technology-138055>.
- Goetzler W, Corporate BTO, Shandross RA, Young JV, Petrichenko O, Ringo DFP, McClive S. Energy savings potential and RD&D opportunities for commercial building HVAC systems. 2017. <https://www.energy.gov/sites/prod/files/2017/12/f46/bto-DOE-Comm-HVAC-Report-12-21-17.pdf>.
- Goetzler B, Guernsey M, Kassuga T, Young J, Savidge T, Bouza A, Neukomm M, Sawyer K. Grid-interactive efficient buildings technical report series: heating, ventilation, and air conditioning (HVAC); water heating; appliances; and refrigeration. 2019. <https://doi.org/10.2172/1577967>.
- Deng J, Wang RZ, Han GY. A review of thermally activated cooling technologies for combined cooling, heating and power systems. *Prog Energy Combust Sci* 2011;37:172–203. <https://doi.org/10.1016/j.pecc.2010.05.003>.
- Montagnino FM. Solar cooling technologies. Design, application and performance of existing projects. *Sol Energy* 2017;154:144–57. <https://doi.org/10.1016/j.solener.2017.01.033>.
- The International Patent Classification (IPC). F25 - refrigeration or cooling; combined heating and refrigeration systems; heat pump systems; manufacture or storage of ice; liquefaction or solidification of gases. n.d. <https://ipcpub.wipo.int/?notion=scheme&version=20220101&symbol=F25B0047000000&menulang=en&lang=en&viewmode=f&fipcc=yes&showdeleted=yes&indexes=yes&s&headings=yes¬es=yes&direction=02n&initial=A&cwid=none&tree=no&searchmode=smart>. [Accessed 13 October 2022].
- The International Patent Classification (IPC). F24F - air-conditioning; air-humidification; ventilation; use of air currents for screening. n.d. <https://ipcpub.wipo.int/?notion=scheme&version=20220101&symbol=F24F&menulang=en&lang=en&viewmode=f&fipcc=no&showdeleted=yes&indexes=no&headings=yes¬es=yes&direction=02n&initial=A&cwid=none&tree=no&searchmode=smart>. [Accessed 13 October 2022].
- Goetzler W, Zogg R, Young J, Johnson C. Energy savings potential and RD&D opportunities for non-vapor-compression HVAC technologies. 2014. <https://doi.org/10.2172/1220817>.

- [37] Mitchell MP, Fabris D, Tomlinson BJ. In: Ross RG, editor. Double vortex tube as heat exchanger and flow impedance for a pulse tube refrigerator. *Cryocoolers 10*. Boston, MA: Springer US; 2002. p. 257–64. https://doi.org/10.1007/0-306-47090-X_30.
- [38] Vhk, Armines, Viegand, Maagøe ApS. (VM), wuppertal institute for climate, environment and energy GmbH. Technology Roadmap in Preparatory/Review Study on Commission Regulation (EC) No. 643/2009 with Regard to Ecodesign Requirements for Household Refrigeration Appliances and Commission Delegated Regulation (EU) No. 1060/2010 with Regard to Energy Labelling, <http://www.ecodesign-fridges.eu/>; 2016.
- [39] The air-conditioning, heating, and refrigeration institute, AHRI 210/240: performance rating of unitary air-conditioning & air-source heat pump equipment. AHRI; 2020. <https://www.ahrinet.org/search-standards/ahri-210240-performance-rating-unitary-air-conditioning-air-source-heat-pump-equipment>. [Accessed 19 April 2023].
- [40] International Organization for Standardization. ISO 5151:2017 Non-ducted air conditioners and heat pumps—testing and rating for performance. <https://www.iso.org/standard/63409.html>. [Accessed 19 April 2023].
- [41] Union European. Directive (EU) 2018/844 of the European Parliament and of the Council of 30 May 2018 amending Directive 2010/31/EU on the energy performance of buildings and Directive 2012/27/EU on energy efficiency (Text with EEA relevance). <https://eur-lex.europa.eu/eli/dir/2018/844/oj/eng>. [Accessed 26 October 2022].
- [42] Pezzutto S. Analysis of the space heating and cooling market in Europe. PhD Thesis. 2014.
- [43] Elmagar E, Lemort V. Cooling concepts for residential buildings: a comparison under climate change scenarios. In: International high performance buildings conference; 2022. <https://docs.lib.purdue.edu/ihpbc/406>.
- [44] Bahman A. Analysis of packaged air conditioning system for high temperature climates. Open Access Dissertations; 2018. https://docs.lib.purdue.edu/open_access_dissertations/1685.
- [45] European Union, COMMISSION REGULATION (EU). 2281 - of 30 November 2016 - implementing Directive 2009/125/EC of the European Parliament and of the Council establishing a framework for the setting of ecodesign requirements for energy-related products, with regard to ecodesign requirements for air heating products, cooling products, high temperature process chillers and fan coil units. n.d. <http://data.europa.eu/eli/reg/2016/2281/oj>; 2016.
- [46] Huang B, Hansen PMS, Viegand J, Riviere P, Asloune H, Dittmann F. Air conditioners and comfort fans, Review of Regulation 206/2012 and 626/2011 Final report. 2018.
- [47] Dittmann Florian, Rivière Philippe, Pascal Stabat. Space cooling technology in Europe - technology data and demand modelling. Deliverable 3.2: cooling technology datasheets in the 14 MSs in the EU28. 2017.
- [48] Fletier T, Steinbach J, Ragwitz M. Mapping and analyses of the current and future (2020 - 2030) heating/cooling fuel deployment (fossil/renewables). Work package 2: assessment of the technologies for the year 2012. https://energy.ec.europa.eu/mapping-and-analyses-current-and-future-2020-2030-heating-cooling-fuel-deployment-fossil-renewables-1_en. [Accessed 2 November 2022].
- [49] European commission, communication from the commission to the European parliament, the council, the European economic and social committee and the committee of the regions on an EU Strategy for heating and cooling. <https://eur-lex.europa.eu/legal-content/EN/TXT/?uri=CELEX%3A52016DC0051>. [Accessed 2 November 2022].
- [50] Liu Z, Zhang L, Gong G, Li H, Tang G. Review of solar thermoelectric cooling technologies for use in zero energy buildings. *Energy Build* 2015;102:207–16. <https://doi.org/10.1016/j.enbuild.2015.05.029>.
- [51] Khalifaa AHN, Faraja JJ, Khaleelb MH. Performance study of two circuits lorenz-mutzner vapour compression cycle. *Int J of Therm Environ Eng* 2017;15: 97–102.
- [52] Ismail M, Yebiyi M, Chaer I. A review of recent advances in emerging alternative heating and cooling technologies. *Energies* 2021;14:502. <https://doi.org/10.3390/en14020502>.
- [53] Mao J, Chen G, Ren Z. Thermoelectric cooling materials. *Nat Mater* 2021;20: 454–61. <https://doi.org/10.1038/s41563-020-00852-w>.
- [54] Go DB, Haase JR, George J, Mannhart J, Wanke R, Nojeh A, Nemanich R. Thermionic energy conversion in the twenty-first century: advances and opportunities for space and terrestrial applications. *Front Mech Eng* 2017;3:13. <https://doi.org/10.3389/fmech.2017.00013>.
- [55] Liang W, Meng S, Zeng Q, Han X. Intrinsic connections between thermionic emission cooling effect and emission characteristics of W-La2O3 cathodes at high temperatures. *Mater Lett* 2022;308:131172. <https://doi.org/10.1016/j.matlet.2021.131172>.
- [56] James NA, Braun JE, Groll EA, Horton WT. Thermodynamic analysis of an electrochemically driven chemical looping heat pump, international refrigeration and air conditioning conference. <https://docs.lib.purdue.edu/iracc/1745>; 2016.
- [57] Tao Y. Electrochemical compression with ION exchange membranes for air conditioning, refrigeration and other related applications. 2017. <https://doi.org/10.13016/M2PV6885W>.
- [58] Yoon WJ, Seo K, Chung HJ, Lee E-J, Kim Y. Performance optimization of a Lorenz-Meutzner cycle charged with hydrocarbon mixtures for a domestic refrigerator-freezer. *Int J Refrig* 2012;35:36–46. <https://doi.org/10.1016/j.jrefrig.2011.09.014>.
- [59] Rice C, Sand J. Initial parametric results using cyclez- an LMTD-specified, lorenz-metzner cycle refrigerator-freezer model, international refrigeration and air conditioning conference. 1990. <https://docs.lib.purdue.edu/iracc/130>.
- [60] Choi S, Han U, Cho H, Lee H. Review: recent advances in household refrigerator cycle technologies. *Appl Therm Eng* 2018;132:560–74. <https://doi.org/10.1016/j.applthermaleng.2017.12.133>.
- [61] Nebot-Andrés L, Sánchez D, Calleja-Anta D, Cabello R, Llopis R. Experimental determination of the optimum intermediate and gas-cooler pressures of a commercial transcritical CO2 refrigeration plant with parallel compression. *Appl Therm Eng* 2021;189:116671. <https://doi.org/10.1016/j.applthermaleng.2021.116671>.
- [62] Llopis R, Nebot-Andrés L, Cabello R, Sánchez D, Catalán-Gil J. Experimental evaluation of a CO2 transcritical refrigeration plant with dedicated mechanical subcooling. *Int J Refrig* 2016;69:361–8. <https://doi.org/10.1016/j.jrefrig.2016.06.009>.
- [63] Barta R, Hugenroth J, Groll E. Modeling of S-ramp energy recover compressor integration in a transcritical carbon dioxide cycle for application in electronics cooling in varying gravity, international refrigeration and air conditioning conference. 2018. <https://docs.lib.purdue.edu/iracc/1988>.
- [64] Yang B, Kurtulus O, Groll E. An integrated model for an oil free carbon dioxide compressor using sanderson-rocker arm motion mechanism, in. <https://www.semanticscholar.org/paper/An-Integrated-Model-for-an-Oil-Free-Carbon-Dioxide-Yang-Kurtulus/ca42139afd5a5ebaba1d56f6eb61290e9053ddb2?p2df>. [Accessed 13 January 2023].
- [65] Barta R B, Groll E A, Hugenroth J J. Modeling of S-RAM energy recovery compressor integration in a transcritical carbon dioxide cycle for application in multi-temperature refrigerated container systems. 2018. <https://doi.org/10.18462/IR.GL.2018.1117>.
- [66] Arpagaus C, Bless F, Bertsch S, Javed A, Schiffmann J. Heat pump driven by a small-scale oil-free turbocompressor – system design and simulation, in. <https://www.semanticscholar.org/paper/Heat-Pump-driven-by-a-Small-Scale-Oil-Free-%E2%80%93-System-Arpagaus-Bless/d0e50b838d95ddc67760630b5c77cd3d5a58e67e7p2df>. [Accessed 13 January 2023].
- [67] Tongdee N, Jandakaew M, Dolwichai T, Thumthae C. Thermodynamics analysis for optimal geometrical parameters and influence of heat sink temperature of gamma-configuration stirling engine. *Energy Proc* 2017;105:1782–8. <https://doi.org/10.1016/j.egypro.2017.03.516>.
- [68] Douglas corporation McDonnell. Application of the radioisotope-fueled stirling engine to circulatory support systems: final report, United States atomic energy commission. Division of Technical Information; 1968.
- [69] Huang Y, Wang B, Cheng L, Wu J, Wang R. Cooling performance measurement of the reverse application of a coaxial free-piston Stirling engine. *Sci Technol Built Environ* 2016;22:556–64. <https://doi.org/10.1080/23744731.2016.1186461>.
- [70] Dai D, Liu Z, Yuan F, Long R, Liu W. Finite time thermodynamic analysis of a solar duplex Stirling refrigerator. *Appl Therm Eng* 2019;156:597–605. <https://doi.org/10.1016/j.applthermaleng.2019.04.098>.
- [71] S VC. Stirling engines: a beginners Guide. Vineeth CS; 2011.
- [72] Tyagi SK, Kaushik SC, Singhal MK. Parametric study of irreversible Stirling and Ericsson cryogenic refrigeration cycles. *Energy Convers Manag* 2002;43: 2297–309. [https://doi.org/10.1016/S0196-8904\(01\)00181-9](https://doi.org/10.1016/S0196-8904(01)00181-9).
- [73] Hugenroth J, Braun J, Groll E, King G. Experimental investigation of a liquid-flooded Ericsson cycle cooler. *Int J Refrig* 2008;31:1241–52. <https://doi.org/10.1016/j.jrefrig.2008.01.015>.
- [74] Getie MZ, Lanzetta F, Bégot S, Admassu BT, Hassen AA. Reversed regenerative Stirling cycle machine for refrigeration application: a review. *Int J Refrig* 2020; 118:173–87. <https://doi.org/10.1016/j.jrefrig.2020.06.007>.
- [75] Erbay LB, Ozturk MM, Dogan B. Overall performance of the duplex Stirling refrigerator. *Energy Convers Manag* 2017;133:196–203. <https://doi.org/10.1016/j.enconman.2016.12.003>.
- [76] Sridhar KR, Nanjundan A, Gottmann M, Swanson TD, Didion J. Evaluation of a reverse Brayton cycle heat pump for lunar base cooling. 1994, 941271. <https://doi.org/10.4271/941271>.
- [77] Biglia A, Comba L, Fabrizio E, Gay P, Mannini A, Mussinato A, Ricauda Aimonino D. Reversed Brayton cycle for food freezing at very low temperatures: energy performance and optimisation. *Int J Refrig* 2017;81:82–95. <https://doi.org/10.1016/j.jrefrig.2017.05.022>.
- [78] Qian S, Geng Y, Wang Y, Ling J, Hwang Y, Radermacher R, Takeuchi I, Cui J. A review of elastocaloric cooling: materials, cycles and system integrations. *Int J Refrig* 2016;64:1–19. <https://doi.org/10.1016/j.jrefrig.2015.12.001>.
- [79] Johra H, Bahl C. Innovative heating and cooling systems based on caloric effects, CLIMA 2022 Conference. In: CLIMA 2022 the 14th REHVA HVAC world congress; 2022. p. 2022. <https://doi.org/10.34641/CLIMA.2022.275>.
- [80] Qian S. Development of thermoelastic cooling systems. Digital Repository at the University of Maryland; 2015. <https://doi.org/10.13016/M26H8Q>.
- [81] Seo J, Braun JD, Dev VM, Mason JA. Driving barocaloric effects in a molecular spin-crossover complex at low pressures. *J Am Chem Soc* 2022;144:6493–503. <https://doi.org/10.1021/jacs.2c01315>.
- [82] Debus K, Gielda T, Kulkarni S. US20120297800 supersonic cooling nozzle inlet. <https://patentscope.wipo.int/search/en/detail.jsf?docId=US76345035&fid=WO2012018627>. [Accessed 18 January 2023].
- [83] Gielda TP. Impact of high-performance computing on new product design : a case study for a Novel cooling system. 2011. <https://www.semanticscholar.org/paper/Impact-of-High-Performance-Computing-on-New-Product-Gielda/fb1095a97abbaf6d362718234908232954807835?p2df>.
- [84] Woods J, Pellegrino J, Kozubal E, Burch J. Design and experimental characterization of a membrane-based absorption heat pump. *J Membr Sci* 2011; 378:85–94. <https://doi.org/10.1016/j.memsci.2010.11.012>.

- [85] Bukshaisha A, Fronk BM. Simulation of seasonal performance of a membrane heat pump system in different climate regions, international refrigeration and air conditioning conference. 2018. <https://docs.lib.purdue.edu/iracc/1977>.
- [86] Lim H, Lee J, Choi S, Kim S, Jung M, Lim J, Kim M. Performance simulation of membrane heat pumps based on vacuum membrane dehumidification system. *J Mech Sci Technol* 2020;34:941–8. <https://doi.org/10.1007/s12206-020-0143-2>.
- [87] Bukshaisha AA, Fronk BM. Simulation of membrane heat pump system performance for space cooling. *Int J Refrig* 2019;99:371–81. <https://doi.org/10.1016/j.ijrefrig.2018.12.010>.
- [88] Bansal P, Vineyard E, Abdelaziz O. Status of not-in-kind refrigeration technologies for household space conditioning, water heating and food refrigeration. *Int J Sustain Built Environ* 2012;1:85–101. <https://doi.org/10.1016/j.ijsbe.2012.07.003>.
- [89] Kitanovski A, Egolf PW. Innovative ideas for future research on magnetocaloric technologies. *Int J Refrig* 2010;33:449–64. <https://doi.org/10.1016/j.ijrefrig.2009.11.005>.
- [90] Agnew B, Maidment GG, Zi Q. Solar powered (Thermally-Driven) cooling systems. In: *Comprehensive renewable energy*. Elsevier; 2022. p. 532–52. <https://doi.org/10.1016/B978-0-12-819727-1.00085-6>.
- [91] Sarbu I, Sebarchievici C. Solar thermal-driven cooling systems. In: *Solar heating and cooling systems*. Elsevier; 2017. p. 241–313. <https://doi.org/10.1016/B978-0-12-811662-3.00007-4>.
- [92] Lai L, Wang X, Kefayati G, Hu E. Evaporative cooling integrated with solid desiccant systems: a review. *Energies* 2021;14:5982. <https://doi.org/10.3390/en14185982>.
- [93] Mohammad Ath, Mat SB, Sulaiman MY, Sopian K, Al-abidi AA. Historical review of liquid desiccant evaporation cooling technology. *Energy Build* 2013;67:22–33. <https://doi.org/10.1016/j.enbuild.2013.08.018>.
- [94] Speerforck A, Schmitz G. Experimental investigation of a ground-coupled desiccant assisted air conditioning system. *Appl Energy* 2016;181:575–85. <https://doi.org/10.1016/j.apenergy.2016.08.036>.
- [95] Guo J, Bilbao JI, Sproul AB. A novel solar cooling cycle – a ground coupled PV/T desiccant cooling (GPVTD) system with low heat source temperatures. *Renew Energy* 2020;162:1273–84. <https://doi.org/10.1016/j.renene.2020.08.050>.
- [96] Das RS, Jain S. Experimental investigations on a solar assisted liquid desiccant cooling system with indirect contact dehumidifier. *Sol Energy* 2017;153:289–300. <https://doi.org/10.1016/j.solener.2017.05.071>.
- [97] Cuce PM. Thermal performance assessment of a novel liquid desiccant-based evaporative cooling system: an experimental investigation. *Energy Build* 2017;138:88–95. <https://doi.org/10.1016/j.enbuild.2016.12.029>.
- [98] Zheng X, Ge TS, Wang RZ. Recent progress on desiccant materials for solid desiccant cooling systems. *Energy* 2014;74:280–94. <https://doi.org/10.1016/j.energy.2014.07.027>.
- [99] Sultan M, El-Sharkawy II, Miyazaki T, Saha BB, Koyama S. An overview of solid desiccant dehumidification and air conditioning systems. *Renew Sustain Energy Rev* 2015;46:16–29. <https://doi.org/10.1016/j.rser.2015.02.038>.
- [100] Vineyard EA, Sand JR, Durfee DJ. Parametric analysis of variables that affect the performance of a desiccant dehumidification system. *Transac-Am Soc Heat Refrig Air Condit Eng* 2000;106:87–94.
- [101] Gupta K. Reusable instant cooler based on endothermic chemical reactions. 2007. p. 5. <https://doi.org/10.15680/LJRSET.2016.0510130>.
- [102] Coulter JO. Case for cooling an electronic device via an endothermic reaction. Google Patents; 2017. <https://patents.google.com/patent/US20170187411A1/en>.
- [103] Herold KE, Radermacher R, Klein SA. Absorption chillers and heat pumps. 0 ed. CRC Press; 2016. <https://doi.org/10.1201/b19625>.
- [104] Kuczyńska A, Szaflik W. Absorption and adsorption chillers applied to air conditioning systems. *Arch Therm* 2010;31:77–94. <https://doi.org/10.2478/v10173-010-0010-0>.
- [105] Kuehn A, Ziegler F, Dawoud B, Schossig P, Wienen J, Critoph R. Thermally driven heat pumps for heating and cooling. 2013. <https://d-nb.info/1066160627/34>.
- [106] Pilatowsky I, Romero RJ, Isaza CA, Gamboa SA, Sebastian PJ, Rivera W. Cogeneration fuel cell-sorption air conditioning systems. London: Springer London; 2011. <https://doi.org/10.1007/978-1-84996-028-1>.
- [107] Florian D, Anies G, Riviere P. Opportunité de développement d'une pompe à chaleur BoostHeat réversible, in: <https://hal-mines-paristech.archives-ouvertes.fr/hal-01677280>. [Accessed 23 January 2023].
- [108] Ibsaine R, Joffroy J-M, Stouffs P. Modelling of a new thermal compressor for supercritical CO₂ heat pump. *Energy* 2016;117:530–9. <https://doi.org/10.1016/j.energy.2016.07.017>.
- [109] Zhao D, Aili A, Zhai Y, Xu S, Tan G, Yin X, Yang R. Radiative sky cooling: fundamental principles, materials, and applications. *Appl Phys Rev* 2019;6:021306. <https://doi.org/10.1063/1.5087281>.
- [110] Urmee T, Hernandez-Manrique J, Petrichenko K, Ganesan K, Baldy O, Onstad M, Fitzgerald D. Mapping existing solutions and best practices on sustainable cooling: scoping review. 2021.
- [111] Dean B, Garcia R, Hamilton I, Hartley B, Jose A, Mehic S, Pasqualetto G, Uwamaliya A, Wadhwa A. Chilling prospects: tracking sustainable cooling for all. 2022. <https://www.seforall.org/chilling-prospects-2022/sustainable-cooling-policy-progress>. [Accessed 16 June 2023].
- [112] Delmastro C, Martinez-Gordon R. IEA space cooling – analysis. <https://www.iea.org/reports/space-cooling>. [Accessed 16 June 2023].
- [113] Huppel G, Schaubroeck T. Forecasting the future sustainability of technology choices: qualitative predictive validity of models as a complement to quantitative uncertainty. *Front Sustain* 2022;3:629653. <https://doi.org/10.3389/frsus.2022.629653>.
- [114] Abedrabbouh O, Koç M, Biçer Y. Sustainability performance of space-cooling technologies and approaches. *Energy Sources, Part A Recovery, Util Environ Eff* 2022;44:9017–42. <https://doi.org/10.1080/15567036.2022.2127979>.
- [115] Yu X, Chan J, Chen C. Review of radiative cooling materials: performance evaluation and design approaches. *Nano Energy* 2021;88:106259. <https://doi.org/10.1016/j.nanoen.2021.106259>.

Appendix B

Chapter 02: *A qualitative assessment of integrated active cooling systems: A review with a focus on system flexibility and climate resilience.*

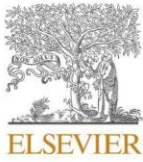

Contents lists available at ScienceDirect

Renewable and Sustainable Energy Reviews

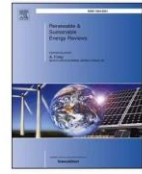
journal homepage: www.elsevier.com/locate/rser

A qualitative assessment of integrated active cooling systems: A review with a focus on system flexibility and climate resilience

Essam Elnagar^{a,*}, Alanis Zeoli^a, Ramin Rahif^b, Shady Attia^b, Vincent Lemort^a

^a Thermodynamics Laboratory, Aerospace and Mechanical Engineering Department, Faculty of Applied Sciences, University of Liège, Belgium

^b Sustainable Building Design Lab, Dept. UEE, Faculty of Applied Sciences, University of Liège, Belgium

ARTICLE INFO

Keywords:

Cooling systems
Cooling demand
System efficiency
System flexibility
Climate resilience

ABSTRACT

Space cooling now has the fastest-growing energy end-use in buildings, with an almost tripled energy demand compared to 1990. This paper provides a state-of-the-art review of different integrated active cooling systems for buildings. The cooling systems are classified based on the energy source, with attention to the performance of the systems under multi-criteria assessment. The assessment criteria are described in five main parameters for energy performance, flexibility to energy sources and integration with secondary systems, climate resilience to heatwaves and power outages, as well as building typology, and technology readiness level. The qualitative assessment shows that electricity-driven systems are widely available in the market and have several applications integrated with PV systems. Therefore, they are more resilient to heatwaves. Only chillers are highly integrated with secondary systems among electricity-driven systems. The study also found that only air-cooled and water-cooled chillers can operate in passive cooling mode. It is found that thermal energy-driven systems are more flexible to be driven by different energy sources, in addition to being more resistant to power outages due to their low electrical input. Finally, some recommendations for further research and practice are given based on the study's strengths and limitations.

1. Introduction

Around 40% of the primary energy consumed in Europe is used in buildings and cooling energy requirements contribute significantly to the overall demand for electricity. There are several ways to cool the building using passive techniques such as shading, natural ventilation, evaporative cooling and various building designs to maintain a cool indoor. Another option is the use of electric fans to increase convective heat transfer around the body and therefore increase the body cooling by circulating air inside rooms but will not remove sensible or latent heat from the building. Currently, climate change has drawn great attention, with the predicted increase in global surface air temperature by the end of this century within a range of 1 and 5.7 K to (1850–1900) period under various Carbon dioxide (CO₂) emission scenarios [1,2]. Therefore, in hot climates, the use of active cooling systems (ACs) is still necessary to provide indoor thermal comfort and decrease indoor temperatures. In tropical climates, using natural ventilation with large window openings is not energy-efficient which encourages high energy use within the building [3]. Another study by Elnagar et al. [4] studied the natural ventilation effect in different climate conditions. The study found that,

only natural ventilation results in a low reduction in cooling energy demand. Therefore, controlled shading is taken into account with natural ventilation.

One of the largest energy consumers in buildings is ACs, which are essential for ensuring occupant comfort. Therefore, performance improvements to classic Heating, Ventilation, and Air-Conditioning (HVAC) systems present an attractive prospect for large energy savings [5]. Currently, various electricity-driven and thermal energy-driven cooling systems are commercially available in different climates. On extremely hot days, space cooling accounts for more than 70% of peak electrical demand in residential buildings in different middle eastern countries and some regions of the United States. Space cooling represented an average of 14% of peak demand globally in 2016 [6]. According to International Energy Agency (IEA), air conditioners and electric fans used to maintain acceptable indoor temperatures account for about 20% of the total electricity utilized in buildings worldwide today [6]. While, according to the International Institute of Refrigeration in Paris, the electricity usage for air-conditioning systems is estimated to be around 45% of the total electricity consumption of residential and commercial buildings [7,8].

Despite the availability of different cooling systems, vapour

* Corresponding author.

E-mail address: essam.elnagar@uliege.be (E. Elnagar).

<https://doi.org/10.1016/j.rser.2023.113179>

Received 28 July 2022; Received in revised form 6 January 2023; Accepted 10 January 2023
1364-0321/© 2023 Elsevier Ltd. All rights reserved.

Abbreviations

Active cooling systems	ACs
Vapour Compression	VC
Carbon dioxide	CO ₂
Energy Efficiency Ratio	EER
Seasonal Energy Efficiency Ratio	SEER
European Seasonal Energy Efficiency Ratio	ESEER
Coefficient of Performance	COP
Fan Coil Unit	FCU
Technology Readiness Level	TRL
Variable Refrigerant Flow	VRF
Electronic Expansion Valve	EEV
Heating, ventilation, and air-conditioning	HVAC
Photovoltaic	PV
Thermal Energy Storage	TES
Ice Thermal Energy Storage	ITES
Indirect Evaporative Cooler	IEC
Borehole Thermal Energy Storage	BTES
Aquifer Thermal Energy Storage	ATES
Ammonia	NH ₃
Lithium Bromide	LiBr

compression (VC) air-conditioning systems are the most widely used systems in residential buildings around the world [9]. In addition to electricity-driven cooling systems, thermal energy-driven cooling systems have been also commercially available in the market for many years based on the availability of a large amount of waste heat to operate the systems. Thermal energy-driven cooling systems are more coupled with renewable energy sources [10].

Previous studies have described various cooling technologies, some of them focused only on VC systems' performance [11–13], while other studies focused on thermal energy-driven cooling systems [14–16]. The most relevant results are shown in a study by Zhang et al. [11], the study conducted a comprehensive qualitative review of cooling techniques with a focus on their performance during heatwaves and power outages. Compression refrigeration technologies were part of the studied technologies, although the study didn't focus on the different types of compression refrigeration systems and their integration with secondary systems. Additionally, a study by Pezzutto et al. [17] investigated the recent advances in alternative cooling technologies using conventional VC systems. The study showed that there are no cooling technologies ready to compete with VC systems in the EU market between 2020 and 2030. Some studies showed that VC air-conditioning systems and refrigerators that are driven by electricity dominate the cooling technologies market by more than 99% [18,19]. Hughes et al. [20] assessed different sustainable active and passive cooling techniques in buildings. The study found that regardless of the significant advancements in active and passive cooling techniques, each technology has its limitations due to the climate conditions and electricity cost. While the study didn't discuss in detail the climate resilience of these cooling technologies. Oropeza-Perez et al. [21] investigated three active and ten passive cooling technologies for dwellings. It has been shown that, under certain outdoor conditions, passive cooling techniques can reduce indoor temperatures as effectively as ACs. In addition to that, a decision-making tool is created to select the optimum technology for the different buildings according to climate, the building type, and the cooling technology's initial cost. The study only took into account three factors, this assessment approach has some drawbacks such as occupants' behaviour, integration between the different technologies, and studying the performance of cooling technologies in severe events such as heatwaves and power outages. Kojok et al. [22] highlighted the most typical standalone cooling technologies used in hybrid cooling in buildings. The

study found that, in comparison to VC cooling systems used alone, hybrid systems based on VC offer significant energy savings and efficiency improvements. Standalone cooling systems have been found to occasionally be more efficient than hybrid ones. For instance, in extremely hot and dry climates, it is not essential to remove latent heat separately using a desiccant system, therefore the comfort level could be achieved with an electric or standalone absorption chiller. In addition to that, a thorough analysis of solar sorption cooling systems is presented by Bataineh et al. [23]. The study came to the conclusion that additional research is still required on solar sorption systems in order to make them energy and cost-competitive with conventional cooling technologies. Despite the numerous studies reviewing cooling systems, there is still a need for a thorough review study that defines and compares different cooling systems (electricity-driven and thermal energy-driven) systems in the HVAC research field. In addition, there is relatively little qualitative assessment discussing all parameters of energy performance, systems' flexibility, resilience to heatwaves and power outages, technology readiness level (TRL), and building type. Lastly, among the relevant studies of resilient cooling technologies, few of them have been discussing the different active cooling technologies and their integration with secondary systems.

This paper provides a valuable contribution by investigating and reviewing the state of the art of different electricity-driven and thermal energy-driven systems and assessing their performance based on the physical principles of each system including three main technical features (reversibility: possibility to reverse the machine to work as a heat pump, recovery: possibility to recover heat at condenser - simultaneous heating and cooling and passivity: possibility to make passive cooling) and different assessment criteria: energy performance, the flexibility of integration with secondary systems and renewable energies, climate resilience to extreme events such as heatwaves and power outages, building type and finally TRL. This paper also qualitatively compares the different cooling systems using those five assessment criteria.

The paper is organized as follows. In section 2, the ACs assessment criteria are presented. Section 3 explains the review methodology and the number of literature review studies in this paper. Section 4 presents the results of the electricity-driven systems (see section 4.1) and thermal energy-driven systems (see section 4.2). Section 5 presents the qualitative comparison between the different ACs. The key findings and recommendations are discussed in section 6 including strengths, limitations, and future directions. Finally, section 7 concludes the paper.

2. Active cooling systems assessment criteria

The following is a list of the parameters studied for each cooling system as shown in Fig. 1. When considering how to create a criteria matrix, various variables must be considered. The topic has been approached from many angles since different stakeholders would emphasize different selection criteria.

2.1. Energy performance

2.1.1. System efficiency

System efficiency is defined by different terms: *Energy Efficiency Ratio* (EER), *Seasonal Energy Efficiency Ratio* (SEER) and another similar standard to the SEER is *European Seasonal Energy Efficiency Ratio* (ESEER). SEER measures how efficiently an air conditioner operates over an entire season, it is a seasonally averaged value calculated from the measured EER values for different outdoor temperatures (20, 25, 30 and 35 °C). The higher the (S)EER, the more efficient the unit. For some cooling technologies, the performance is still measured by the Coefficient of performance (COP). The system efficiency of the AC system is expressed by the energy label with a scale from A+++ to D in some types, and A+++ to G in other types [24]. According to the COMMISSION DELEGATED REGULATION (EU) No 626/2011, "the energy efficiency classes for air conditioners, except for single ducts and double ducts

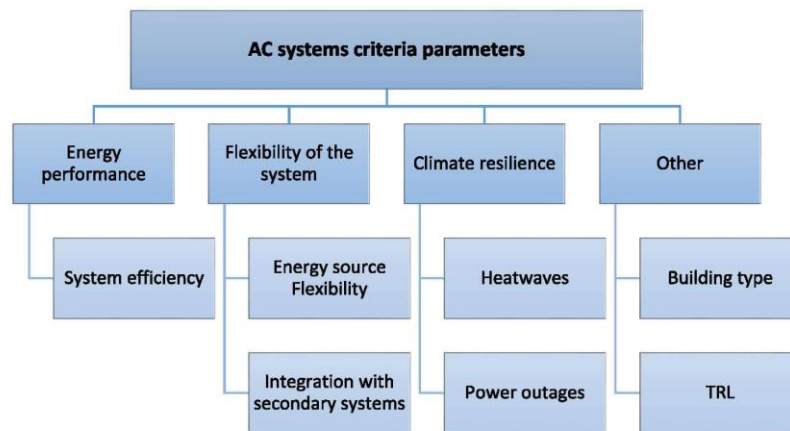

Fig. 1. Active cooling systems assessment criteria.

systems, start from SEER < 2.60 for G class to SEER \geq 8.50 for A+++ class” [24]. People regularly purchase air conditioners with average efficiencies of less than half of what is offered in all major marketplaces [6]. More efficient ACs cut CO₂ emissions from space cooling, especially when the systems are combined with cleaner energy sources.

2.2. Flexibility of the system

2.2.1. Energy source flexibility

One of the most promising strategies is the integration of multi-energy systems with different energy sources to meet buildings’ energy demands. This parameter considers the integration of different energy sources into the building as a hybrid system. It also considers the integration with renewable energy sources. The increasing usage of primary energy by conventional air conditioners is tackled by the introduction of renewable-based air-conditioning systems. The integration with renewable energies helps in reducing CO₂ emissions. This factor is qualitatively based on the flexibility of the primary AC system to be driven by different energy sources and to be integrated with different renewable energy sources.

2.2.2. Integration with secondary systems

This factor refers to the integration between the primary AC system components and the secondary systems such as fan coil units (FCUs) and radiant floor systems which makes the operating conditions/temperature for the system wider. While the integration with secondary systems can also affect the complexity of the system. This factor is qualitatively based on the flexibility of the primary AC system to be integrated with secondary systems as part of the large HVAC system.

2.3. Climate resilience

2.3.1. Heatwaves

Extreme events such as heatwaves have an effect on cooling systems and influence occupant indoor thermal comfort. This parameter explains cooling systems’ resilience and their ability to cope with such extreme events [11,25]. The World Meteorological Organization defines a heatwave as “five or more consecutive days of prolonged heat, i.e. with a daily maximum temperature at least 5°C higher than the average maximum” and some countries have adopted their standards [26].

2.3.2. Power outages

Cooling systems can fail to operate in case of disruptive events such as power outages. This parameter refers to the resilience of the different cooling systems to power outages and their ability to adapt after the

failure.

2.4. Other

2.4.1. Building type

Selecting the accurate AC system for a building does not only depend on the AC type but also on the building type. AC systems are installed in different building types such as industrial, commercial, residential and institutional buildings.

2.4.2. TRL

TRL is a system used to determine technology maturity, “TRL is based on a scale from 1 to 9, with 9 being the most advanced technology”, according to the U.S. Department of Energy’s Technology Readiness Assessment Guide [27]. This factor examines the different active cooling technologies’ readiness levels.

3. Review methodology

A comprehensive review is conducted to assess different ACs. A critical analysis of the available literature was used to conduct this review through different databases including Google Scholar, Web of Science Elsevier (Science Direct), SpringerLink and Scopus. Various keywords have been used for each cooling technology to perform the review. We have mainly focused on recent publications but there was no limit to the publication period. Table 1 shows the statistics of the reviewed literature to assess the systems.

4. Cooling systems

AC systems, as shown in Fig. 2, are classified into two main categories based on the energy source. There are electricity-driven AC units and thermal energy-driven AC units (heat, gas, etc.). Different types of

Table 1
Literature review statistics for the different cooling technologies.

Cooling Technology	Number of References	Publication Year
Split systems	36	1993–2021
Packaged Units	12	2004–2019
Air-cooled chillers	27	1996–2021
Water-cooled chillers	22	1981–2021
Evaporative cooled chillers	21	2005–2021
Sorption systems	15	1995–2021
Ejector cooling system	11	2011–2016
Desiccant systems	15	1992–2021

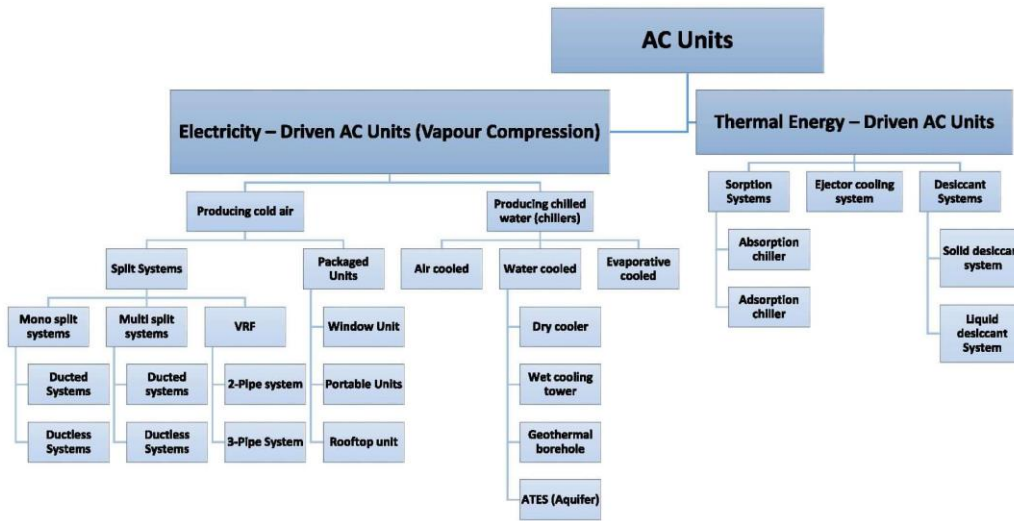

Fig. 2. Classification of active cooling systems discussed in this study based on the energy source.

electricity-driven AC units exist, i.e., systems producing cold air and systems producing chilled water. Thermal energy-driven AC systems include several types (sorption chiller, ejector cooling system and desiccant systems). Several energy sources are used to power the AC units: electricity, natural gas, heat, or solar power. In the 1960s, gas-powered air conditioner units were common. However, the most common way to power AC units is still by using electricity.

The compatibility of AC units to be driven by different energy sources is an advantage for some specific AC systems which is a key

factor in our assessment criteria related to the flexibility of the system. The different types of electricity-driven and thermal energy-driven AC units are discussed in this paper.

This section reviews the cooling technologies shown in Fig. 2 from the following aspects: the physical principle of each system, the assessment criteria shown above, and technical details regarding the possibility to reverse the machine to work as a heat pump, referred to as "REV", the possibility to recover heat at the condenser (simultaneous heating and cooling), "REC", and the possibility to make passive cooling,

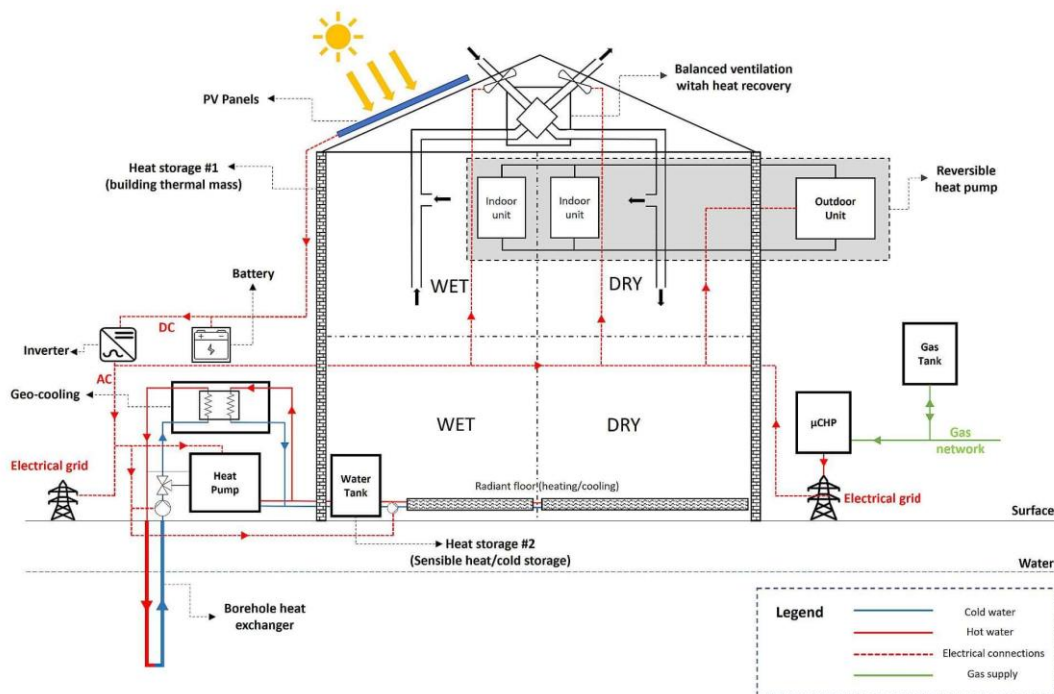

Fig. 3. Integrated electricity-driven cooling systems (primary systems) with secondary systems and renewable energy sources (this figure gives an overview of the common integration, but it is not generic).

“PAS”.

To give an overview of the systems' similarities and differences, a comparison matrix of the ACs is provided in Table 2. The cooling systems are compared based on the aforementioned parameters. The first section of the table provides technical details about the cooling systems regarding reversibility, simultaneous heating and cooling, and the possibility to perform passive cooling. Due to the binary nature of those characteristics, the comparison between systems is quite straightforward. The rest of the parameters are evaluated qualitatively by 'high', 'medium', or 'low' grades. The attribution of each system is based on the performance of this system compared to the average of the other cooling systems in the same category.

4.1. Electricity-driven AC units

Currently, the most common type of AC system mainly in residential buildings is the VC system which uses electricity as the energy source, i.e., the first group in Fig. 2. In practice, the most common types of electricity-driven ACs are available in various configurations: split and packaged systems; ducted and ductless; stationary and portable.

Fig. 3 shows an example of the common integration between primary cooling systems (electricity-driven systems), secondary systems as well as renewable energy sources in a building. The electricity-driven system is represented in the figure by an indoor unit and an outdoor unit (see Fig. 4, Fig. 5, and Fig. 6 for the detailed schematics of electricity-driven systems). The figure also shows the 3 main types of ground coupling by using a borehole heat exchanger or dynamic aquifer or static aquifer. In addition to that, PV panels are used as an additional electricity source in the building to drive the heat pumps. Mechanical ventilation can also be provided by using for example a balanced mechanical ventilation system with heat recovery which sometimes can be bypassed. The integration also allows the heating or cooling of the building by radiant heating/cooling technology. The EER of electricity-driven AC units is calculated as follows in equation (1) [28]:

$$EER = \frac{\dot{Q}_{cool}}{W_{elec}} \quad (1)$$

where.

- \dot{Q}_{cool} : is the cooling capacity of the system [kW]
- W_{elec} : is the electrical power consumed by the system [kW]

4.1.1. Producing cold air

The systems that produce cold air are divided into two main

categories, split systems (mono/mini-split systems, multi-split systems and VRF systems), and packaged systems (window units, terminal units, portable units and rooftop units).

4.1.1.1. Split systems. A split system air conditioner is a reversible air source heat pump divided between one or several indoor units and one outdoor unit. Air-to-air AC means an air conditioner that uses indoor air as the cold heat source and outdoor air as the hot heat sink. In the split system, the condensing unit consisting of compressor and condenser coils is located outside the building, while the indoor unit consisting of an evaporator coil and air filter is located inside the building. In split systems, the secondary fluid in both the indoor units and the outdoor unit is air.

a Mono-split systems

Mono-split system is the simplest air-conditioning unit. It is designed to condition a small area or one room. It consists of one indoor unit including an evaporator and one outdoor unit including a condenser, a compressor and a fan. Mono-split systems are available in different cooling capacities ranging from approximately 3.5 kW–14 kW [29]. The schematic diagram is shown in Fig. 4 (a).

b Multi-split systems

A multi-split air conditioner means an air conditioner with an outdoor unit and one or more indoor units. The maximum cooling capacity of multi-split systems depends on the total number of indoor units, the capacity range is between 12 kW and 30 kW with 4 indoor units, but it could reach up to 50 kW with 6 indoor units [29]. The schematic diagram is shown in Fig. 4 (b).

Mono(mini)-split and multi-Split systems are both reversible systems and can work as heat pumps but without heat recovery. A 2-pipe Variable Refrigerant Flow (VRF) system is a reversible system without heat recovery similar to multi-split systems (therefore, it provides either heating or cooling according to the selected mode), while the heat recovery VRF system that provides both heating and cooling simultaneously, is the 3-pipe VRF system [30].

Among more than certified 3000 split reversible systems (≤ 12 kW) according to Eurovent certification, the SEER varies between 2.71 and 10.6 in some systems [31]. The EER has also a wide range between 2.11 and 6.45 [24].

Split systems (mono-split and multi-split) can also be divided into two main types.

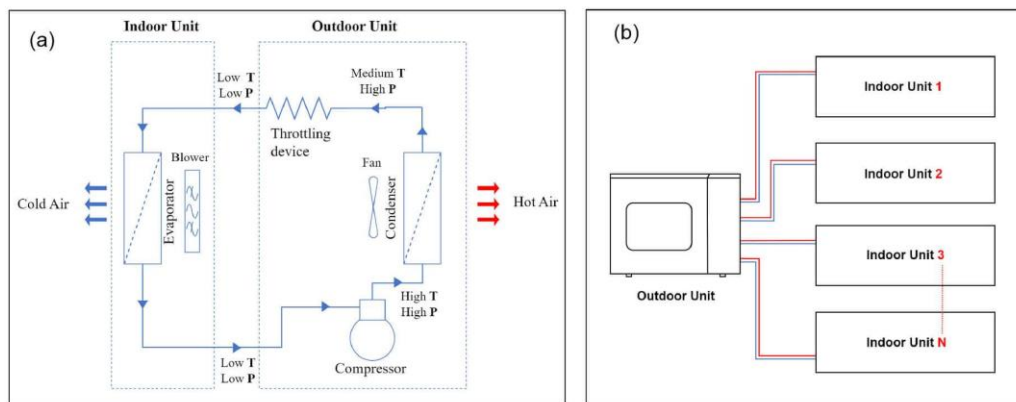

Fig. 4. Split Systems air conditioner (a) Mono-split system schematic diagram (b) Configuration of a multi-split system.

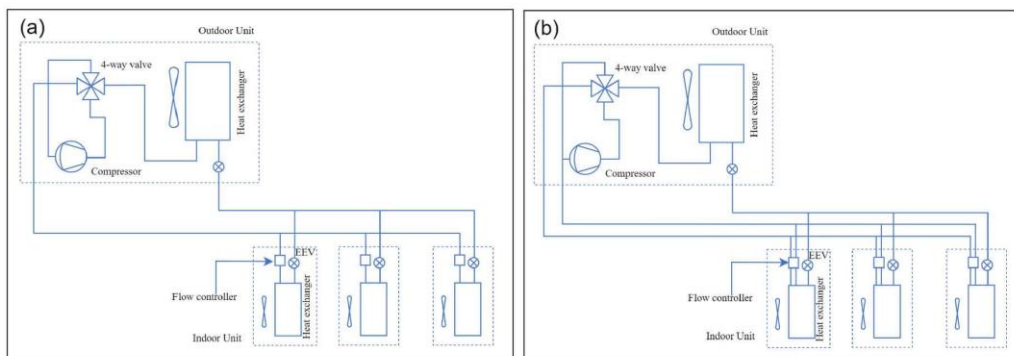

Fig. 5. VRF systems schematic diagram (a) two-pipe VRF system (b) three-pipe VRF system.

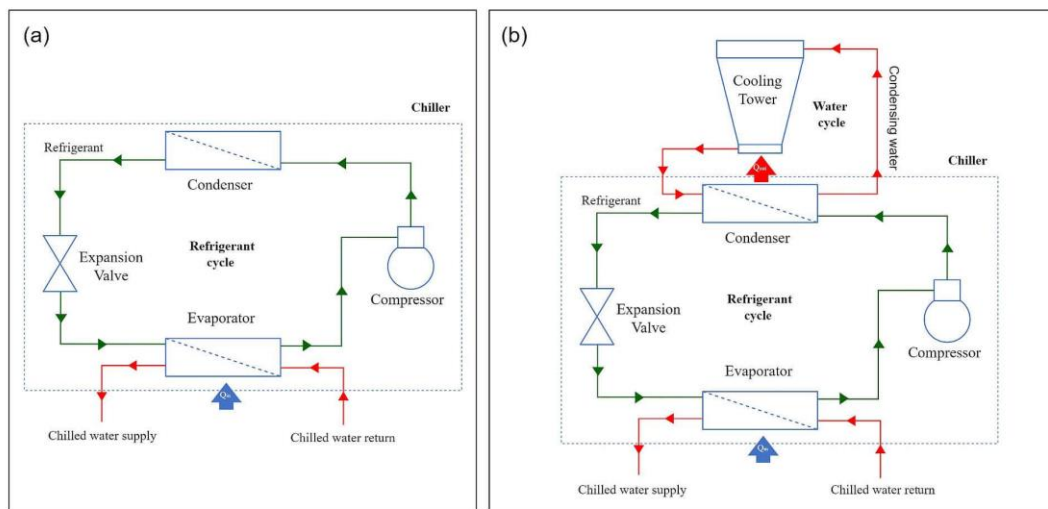

Fig. 6. AC systems producing cold water (chillers) (a) air-cooled chiller schematic diagram (b) water-cooled chiller schematic diagram.

- Ducted systems: in ducted split systems, the evaporator is located in a central location to provide cooling through a system of ducts in different building types [29].
- Ductless systems: ductless split systems provide space conditioning by distributing low-pressure refrigerant to one or more evaporators (typically up to four) located in conditioned spaces through a network of insulated refrigerant lines [29]. Ductless systems do not require any ductwork and could be installed anywhere. These units work in the same way as the traditional (ducted systems), just without the air ducts. Ductless split systems are the primary systems in residential buildings because of their small size and energy savings potential as they prevent duct air leakage from causing losses of conditioned energy. The performance of the ductless system depends on the appropriate placement of the indoor units. To moderately distribute the conditioned air around the room, the evaporator should be placed properly. Improper placement can result in ineffective space conditioning. Ductless multi-split systems allow for an energy consumption reduction compared to ducted systems. Multi-evaporator systems' zone cooling control allows for even more energy savings. Overall, the HVAC energy consumption is approximately reduced by 20% using a ductless AC system that operates at the same efficiency as a ducted split system [29].

Split systems are mainly powered by electricity, not gas, hence, they are not very flexible to different energy sources and usually rely on the electricity grid. However, they can be powered by other electricity sources such as PV panels or gensets (typically as a backup system as explained hereunder). Ductless split units are ideal cooling systems that can work with PV panels and they are widely used [32]. These systems have previously been developed as solar-powered air conditioner that operates using photovoltaic (PV) panels and commercial power supplies [32]. The most important finding was that by reducing the building cooling load, the size of the PV system required could be drastically decreased; by minimizing the cooling load by over 75%, the required PV array size was reduced by a factor of four [33].

In addition to that, split systems could be integrated with ice thermal energy storage (ITES) enabling the system to provide cooling without being connected to the grid for specific hours during the day. Ahmad et al. [34] showed that TES allows the split units to shift peak load and work during power blackouts for long periods, but the system is not commercialized yet and has a drawback of the large space needed to house the storage tank.

Extreme weather conditions can affect the cooling capacity of the system and its performance. Wang et al. [35] studied the impact of the outdoor air temperature on the COP of the split system, They showed that the COP decreases from 3.1 to 2.65 with the increase of the outdoor

temperature by 15 K from 30 °C to 45 °C. Hajidavalloo and Eghtedari [36] showed that an evaporative-cooled condenser could be used to maintain the cooling capacity of the split system at high temperatures. Abdelaziz et al. [37] assessed the COP for different refrigerants at high and extreme ambient temperatures for mini-split systems. The study showed that R-290 produced a COP 8% higher than the baseline with R-22 under extreme test conditions.

Since split systems rely on electricity, they are vulnerable to power outages on their own. Therefore, split systems alone are not extremely resilient to heatwaves and power outages. To increase this robustness as previously mentioned, integration with renewable energies such as solar-powered systems, integration with thermal storage such as ITES or cold-water tanks, integration with electrochemical batteries, or integration with backup gensets is required for providing enough backup power for full operation during a blackout.

Overall, split systems have a wide range of systems and capacities that are available to cool all types of buildings (residential and commercial) with an advantage to ductless systems over ducted systems, which shows TRL 9 for split systems.

c VRF Systems

VRF systems operate on the direct expansion principle that uses one compressor-heat exchanger (outdoor unit) and possible numerous heat exchangers (indoor units) controlled by controllable expansion valves to provide cooling (evaporator mode) and heating (condenser mode). The mass flow rate is controlled by the electronic expansion valve (EEV). In reaction to zone thermal measurements, this allows the VRF to be changed. Since the cycle in VRF systems is reversible so they can operate as reversible heat pumps, and the cycle can provide heating and/or cooling [38].

VRF systems are generally characterized by a higher cooling capacity than traditional split systems with cooling capacities mainly over 12 kW and can reach more than 60 kW [39]. VRF systems with a Eurovent Certified Performance have EERs varying around 3–4 [40]. There exist two types of VRF systems as shown in see Fig. 5.

- 2-pipe system: with a 2-pipe system, the whole system is either cooling or heating. The schematic of the 2-pipe system is shown in Fig. 5 (a).
- 3-pipe system: with a 3-pipe system, there can be both heating and cooling in different zones as shown in Fig. 5 (b). Generally, the 3-pipe system is the most popular because it gives greater control. It is also better if some rooms constantly require cooling while other areas may vary between heating and cooling requirements depending on the weather. VRF systems can transfer “heat” and “cold” according to the local need with very low energy consumption.

There are various working modes for VRF systems to provide only heating, only cooling, or heating and cooling simultaneously. In the first working mode (cooling mode only), all the indoor units work in cooling mode only while in the second working mode (heating mode only), all the indoor units work in heating mode. In addition to that in some cases for the 3-pipe VRF system, there is a heat recovery mode with cooling demand equal, higher, or lower than the heating demand, in this case, some indoor units work in heating mode while the others work in cooling mode depending on the demand.

Compared to conventional air-conditioning systems, these systems can control room-to-room temperature [41], without the use of air and water distribution circuits. A 3-pipe VRF system may deliver both cooling and heating simultaneously. However, VRFs have several drawbacks compared to air and water distribution systems. They can have much longer refrigerant pipes, hence a higher refrigerant charge and higher refrigerant pressure drop along the pipes and they also have a more complex control system [42].

4.1.1.2. Packaged units. Packaged air conditioners are also known as unitary systems. The evaporator, condenser and compressor are contained in a single box assembled at the factory site, which ensures the high quality of the packaged unit. Moreover, refrigerant charging is also done at the factory, avoiding potential issues linked to piping, evacuation, refrigerant charging, and leak testing onsite. The unit can also be shipped very easily to the site. Overall, the resulting benefit of packaging is cost reduction [43]. Packaged ACs can have various sizes, ranging from single-room units that can fit through a window to large rooftop units that can cool an entire building [6].

Similar to split systems, packaged unit systems can be reversible but cannot be used to recover both heat and cold.

Faramarzi et al. [44] evaluated the performance of packaged rooftop air-conditioning units at high ambient temperatures. They used six units coming from three different manufacturers. The standard units had a SEER of around 2.9 and an EER of around 2.5 while the SEER and EER of high-efficiency units were around 3.7 and 3.2 respectively.

Packaged AC systems can be integrated with thermal energy storage (TES) systems. TES systems can shift electric demand to off-peak hours and come with energy savings. TES also offers the opportunity to improve renewable energy systems integration. The integration could be measured with source energy reduction, fossil fuel consumption reduction, emissions reduction, and cost-effectiveness [45]. Regarding resilience to heatwaves, packaged AC systems are similar to split AC systems.

Packaged units are widely available on the market with a large range of systems and capacities to cool all types of buildings. Although they are more popular in the US than in Europe where packaged systems represent only 5% of the AC market share [39]. Overall Packaged systems have a TRL 9.

According to IEA [6], the main packaged ACs are divided into four main types.

a Window units

Window units can fit into a standard window frame due to their compact size and are sometimes called “through-the-wall” units. Window air conditioners are usually used for small air-conditioning capacities of up to 17 kW [46].

b Terminal units

Packaged terminal ACs are characterized by a large unit under a window that has a grilled opening that passes through the wall connecting the condenser and the evaporator [47].

c Portable units

Portable units are designed to be easily carried inside a building, with a tube to remove the unit’s heated air to the exterior [6,47].

d Rooftop units

Rooftop units, or outdoor packaged units, are larger systems that use ducts to deliver cold air into the building. Those units are commonly used in places like restaurants, homes, small halls, etc. They have higher cooling capacities than window units, up to 50 kW [46].

4.1.2. Producing cold water (chillers)

Chillers are large ACs that produce and distribute chilled water through a cooling network, made up of pipes and heat exchangers, to terminal units and cooling coils in air handling units that cool the indoor air. The main advantage of chillers is that they are very flexible regarding integration with secondary systems. They can easily be coupled with a thermal storage system (generally ice or chilled water) to shift the energy usage of the HVAC system from on-peak to off-peak periods [5]. Depending on the requirement of the terminal unit they

can also provide water at a higher or lower temperature. Low-temperature systems such as cooling coils require water around 7 °C while high-temperature systems such as radiant ceilings use water at 18 °C [48]. If connected to an ice storage system, the temperature of chilled water is typically around −5 °C during charging (an aqueous solution of glycol, also called brine, must be used). Similarly, as air-conditioning systems, chillers are electricity-driven, they are not very flexible to energy sources, but they can be partly or entirely powered by PV panels or other renewable energy sources.

Electricity-driven water chillers are vulnerable to power outages. As already mentioned, their robustness can be increased by integration with renewable energies or TES to provide enough backup power for full operation during a blackout. They could also be backed up by some gas-driven or diesel-driven gensets, in case the system cannot be stopped.

Chillers have a wide range of systems and capacities that are available to cool all types of buildings (residential and commercial), which gives them TRL 9.

There exist several types of water chiller systems that vary depending on the way the heat harvested in the building is evacuated. The heat evacuation is done through the condenser, which can be either air-cooled, water-cooled or evaporative-cooled. The main characteristics, advantages and drawbacks of those types of systems are described hereunder, as well as their energy performance.

4.1.2.1. Air cooled. In air-cooled chillers, one or more fans are used to cool the condenser coils as the heat generated by the refrigerant is rejected directly to the outside air. The air-cooled condensers use ambient air to absorb the sensible and latent heat energy dissipated by the refrigerant during the process of condensation. Since convective heat transfer coefficients are lower with air than with water, the air-cooled condensers are larger and mostly less efficient compared to water-cooled condensers in average operating conditions. The air-cooled chiller schematic is shown in Fig. 6 (a).

This system is more often installed in smaller chiller plants, generally below 700 kW, because space, water treatment, additional maintenance cost and initial cost associated with the cooling tower, and condenser water pump outweigh the energy benefit. The EER of typical air-cooled systems varies between 2.8 and 3.1 [49]. This efficiency is strongly linked to the outdoor temperature and the part-load ratio of the chiller. The energy efficiency decreases at higher ambient temperatures and sometimes at part load.

Compared to water-cooled condensers, it operates at a higher condensing temperature; hence the performance of the compressor of the refrigeration system is 15–20% lower. The condensing pressure can be decreased by increasing the fan speed of the condenser, hence decreasing the energy consumption of the compressor. However, it simultaneously increases the consumption of the fan and a trade-off has to be found.

Another drawback related to the higher condensing temperature is that air-cooled chillers are generally less resilient to heatwaves than water-cooled chillers. Using the outdoor air as a cooling medium means that the system performance is strongly dependent on the outdoor conditions.

4.1.2.2. Water cooled. In water-cooled chillers, heat is rejected to water, which is pumped to a dry-cooler or a wet cooling tower and circulated.

It is proven that water-cooled chillers are more energy-efficient compared to air-cooled chillers. Water-cooled condensers are smaller than air-cooled to provide the same cooling effect and they are also more efficient. Generally, they can operate at lower condensing pressure, since the theoretical water temperature limit is the wet bulb of the outdoor air. However, it could become untrue in case of large pinch points between the heat exchangers.

Another advantage of water-cooled chillers is that they can be

bypassed to perform free chilling. The cold water that is produced to cool the condenser of the chiller can be directly or indirectly (by heat exchanger decoupling) used in the terminal units [50]. Generally, water-cooled chillers have higher capital costs than air-cooled chillers.

The EER of water-cooled chillers is generally between 4.9 and 7.8 [49]. As for air-cooled chillers, the chiller energy efficiency drops when operating at part loads and more significantly at a very low part load below 30%, but it depends on the load control mechanism based on the type of the compressor, in addition to that, the efficiency also decreases at higher condenser water temperatures. The water-cooled chiller schematic is shown in Fig. 6 (b).

a Dry cooler

Due to several reasons, such as environmental regulations or water consumption restrictions, air-cooled condensers, and especially natural draft dry cooling towers, are becoming a more favourable choice for power plants even though they show reduced efficiency at high ambient air temperatures [51,52]. During hot days, it is possible to improve the efficiency of dry cooling towers by using techniques such as water spraying [53,54].

b Wet cooling tower

Cooling towers rely on water evaporation. As such, circulating water can potentially be cooled down to the outdoor air wet-bulb temperature. Compared to dry cooling towers, wet cooling towers are more effective and have a substantially smaller surface area [55]. However, the water consumption of wet cooling towers is larger due to evaporation, drift and draining losses [56]. There is approximately 1% evaporation from the total water flow for each 7 K temperature change in the exhaust water temperature of the cooling tower [57].

Cooling towers can be either natural or mechanical drafts, meaning that the airflow through the cooling tower can be induced either by natural means or with fans [58]. Less space is required for mechanical draft cooling towers than for natural draft ones but the fans require electrical energy, which comes with higher energy consumption (fan power is approximately 1.8% and the pump power 0.2% of the cooling capacity) [59] and higher operating costs [60].

The Performance of wet cooling towers can be further enhanced by pre-cooling the air entering the tower. Pre-cooling of the air can be done through an “indirect evaporative cooler” (IEC), which consists of a water-to-air heat exchanger. Part of the cold water produced by the cooling tower is diverted and used in the IEC to pre-cool the outside air entering the tower. In such a configuration, the temperature limit of the circulating water becomes the dew point of the outdoor air, rather than the wet bulb temperature [61].

c Geothermal borehole

The temperature of the earth remains relatively constant at depth, being warmer than the air temperature in winter and colder in summer. Geothermal boreholes allow rejecting heat in the ground to provide a lower temperature heat sink than outdoor air [5].

Borehole thermal energy storage (BTES) systems can also be used for seasonal TES by transferring heat or cold to the ground. Heat and cold can be stored in the ground over either short-term or long-term periods at a rather low cost. When the ground temperature is higher than the temperature at which chilled water should be provided to the terminal units, a chiller must be used to provide chilled water to the conditioned space at the desired temperature. If the temperature of the ground is low enough, it is possible to perform passive cooling (called “geocooling”), which can be the case if a high-temperature emitter is used, such as radiant panels or chilled beams. Available low ground temperatures will result from the history of heat extraction during the heating season. In geocooling mode, the cooling system consumes low amounts of energy

[62], associated with water-circulating pumps, leading to typical SEER values of 12 or more.

BTES is mainly used for combined heating and cooling, typically in well-insulated office buildings which have cooling requirements in summer due to high internal heat gains. The heat is then delivered to the BTES for seasonal storage. To avoid temperature drifts in the ground, heating and cooling loads should be balanced over the year [63].

d Aquifer thermal energy storage (ATES)

ATES is, on the contrary, an open-loop cooling solution that depends on the existence of an aquifer. It consists of at least two separate wells, one for the extraction of groundwater, and another for the reinjection [64].

During winter, cold can be stored in the aquifer, for example with a heat pump that extracts heat from the aquifer to cover the heating needs in the building. In summer, the stored cold can be used for cooling purposes. In static aquifers, thermal energy is stored seasonally. In dynamic aquifers, however, there is a flow of underground water that ensures a constant temperature of the water but prevents seasonal storage. The main advantage of this technique is that during the cooling season, it is sometimes possible to perform passive cooling by taking advantage of the sufficiently cold ground water temperature. In this case, the chillers are unnecessary, resulting in large energy savings. In most cases, the use of chillers is significantly reduced, which leads to major savings on electricity [65].

4.1.2.3. Evaporative cooled. Hybrid evaporative air-cooled condensers are a combination of a cooling tower and an air-cooled refrigerant condenser that takes the profit of adiabatic cooling. The hot refrigerant gas passes through a "tube to plate" design evaporative condenser and water cascades over its surface. Air is drawn through the condenser and some of the water evaporates causing heat transfer. In comparison to an air-cooled system, the evaporative condenser results in a lower condensing temperature. As a result, it is considerably more efficient than air-cooled condensers.

Compared to water-cooled condensers, this system eliminates cooling towers and condenser water pumps, saving initial and operating costs for additional auxiliaries.

Hajidavallo and Eghtedari [36] experimentally showed that an evaporative cooler coupled with an air-cooled condenser can reduce the power consumption of the air-conditioner by up to 20% and increase the system EER by 50%. They also showed that evaporative-cooled chillers are less sensitive to outdoor air conditions than dray air-cooled chillers.

Youbi-Idrissi et al. [66] modelled a sprayed air-cooled condenser coupled to a refrigeration system. They showed that compared to a dry-cooled air condenser, the EER and calorific capacity of the system increased by 55 and 13% respectively.

Yu and Chan [67] investigated the usage of mist pre-cooling to improve the EER of air-cooled chillers. They estimated that the annual energy usage could be decreased by up to 18%.

4.2. Thermal energy-driven AC units

The different types of thermal energy-driven systems are shown in the second group of Fig. 2. There are different cooling techniques driven by low-temperature heat sources, including absorption, adsorption, desiccant, and ejector cooling systems. Absorption is the most extensively utilized of these methods, accounting for 59% of installed thermal-energy-driven systems in Europe, compared to 11% for adsorption and 23% for desiccant cooling [68].

The electrical energy input of thermal energy-driven cooling systems often is negligibly small. Therefore, the electrical COP (COP_{elec}) can be used to distinguish it from the thermal COP (COP_{th}). COP_{elec} is defined as the amount of heat extracted by the evaporator divided by the amount

of electricity consumed as shown in equation (2) [69]. COP_{th} is defined as the amount of heat extracted by the evaporator divided by the amount of required heat by the system as shown in equation (3) [69].

$$COP_{elec} = \frac{\dot{Q}_{ev}}{\dot{W}_{elec}} \quad (2)$$

$$COP_{th} = \frac{\dot{Q}_{ev}}{\dot{Q}_{gen}} \quad (3)$$

As explained previously in Fig. 3 for the integration between the different cooling systems for the electricity-driven systems category. Fig. 7 also shows the integration between the primary (thermal energy-driven systems), secondary systems as well as renewable energy sources. The thermal energy-driven cooling systems are represented by sorption cooling systems, ejector cooling systems, and desiccant cooling systems (see Fig. 8, Figs. 9 and 10 for the detailed schematics of thermal energy-driven systems). There is also a connection between the thermal panel and biomass supply as energy sources for thermal energy-driven systems.

4.2.1. Sorption chiller

Sorption cooling systems are thermal energy-driven AC units as they use heat to produce cooling based on the solid and liquid sorption process. They could be classified based on the sorption mechanism into absorption and adsorption cooling systems. Absorption and adsorption cooling systems are similar to the traditional VC refrigeration systems, with the primary distinction being that heat rather than mechanical work drives the cycle [19].

The sorption cooling system has four main components: condenser, evaporator, generator and absorber components [70]. To extract vapour refrigerant from the high-pressure sorbent, heat is provided to the generator (high-temperature heat source). This heat is the energy input provided to the machine. The condenser condenses the vapour refrigerant, rejecting heat to the ambient (medium temperature heat sink). After the condenser, to reduce the pressure of the liquid refrigerant, the latter flows through an expansion valve to the evaporator where the refrigerant evaporates, producing a cooling effect (low-temperature heat source) [70]. Finally, the vaporized low-pressure refrigerant is absorbed by the sorbent, rejecting heat to the ambient (medium temperature heat sink). The schematic diagram of the sorption cooling systems is shown in Fig. 8. Due to the significant environmental characteristics, sorption cooling systems, especially adsorption chillers, are becoming more and more popular [71].

Sorption cooling systems can work as heat pumps since they could absorb heat at low temperature and pump it to a heat sink at medium temperatures [72]. In addition to that, they can offer heat recovery and be used for both heating and cooling purposes simultaneously [73].

There are two types of sorption cooling systems and both systems have similar components.

4.2.1.1. Absorption chiller. Absorption chillers use lithium Bromide (LiBr) or water as the absorbent fluid and water or ammonia (NH_3) as the refrigerant. The absorption chiller has a higher COP value than the adsorption chiller [71]. In the absorption chiller, a "thermal compressor" is used, rather than the mechanical compressor used in VC refrigeration systems as shown in Fig. 8 (a) [74].

4.2.1.2. Adsorption chiller. Adsorption chillers use silica gel, activated carbon or zeolites as the adsorbents and water as the refrigerant. Compared to absorption systems, adsorption systems are less sensitive to the temperatures of the heating source and the cooling water. The schematic of the adsorption chiller is shown in Fig. 8 (b).

Kuczyńska & Szaflik [71] analysed the COP of the absorption and adsorption cooling systems, the study showed that the COP varies with the temperatures of the driving source and cooling water. Absorption

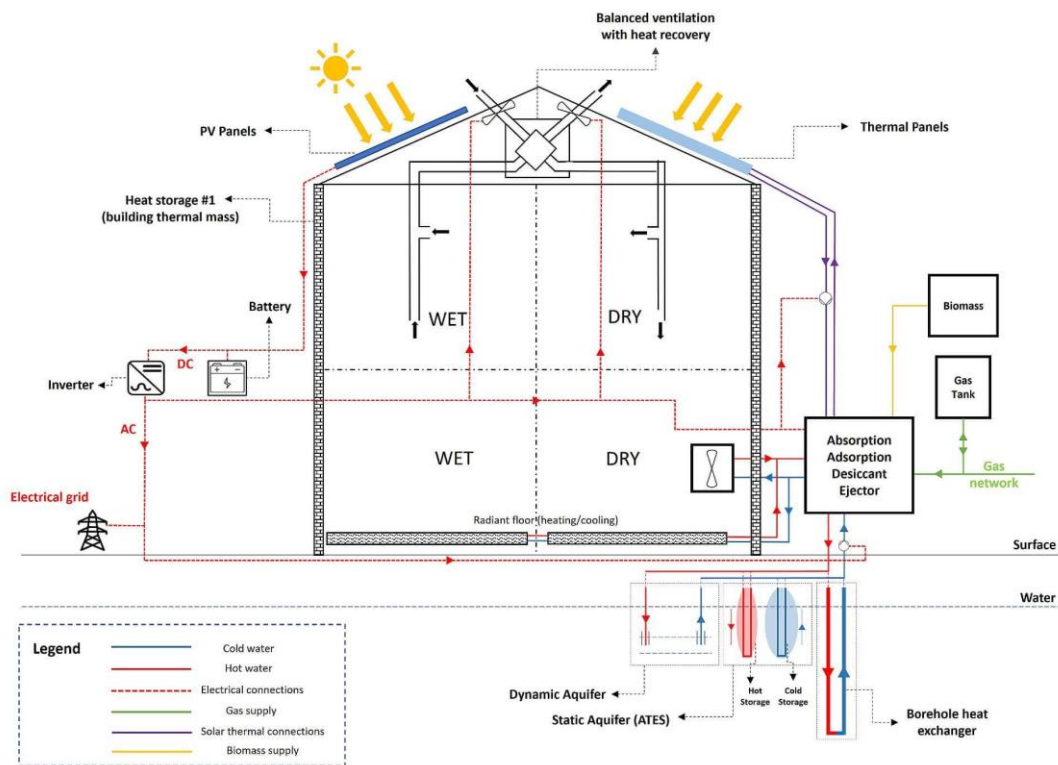

Fig. 7. Integrated heat-driven cooling systems (primary systems) with secondary systems and renewable energy sources (this figure gives an overview of the common integration, but it is not generic).

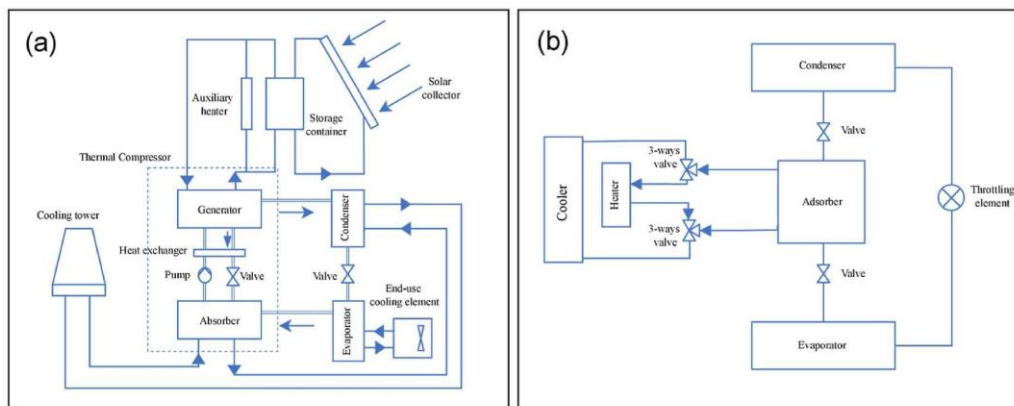

Fig. 8. Conventional solar sorption cooling systems schematic diagram (a) absorption chiller (b) adsorption chiller.

chillers reach higher COP values than adsorption chillers. The COP of the absorption chiller varies between 0.7 and 1.2 depending on the cycle configuration (single or double effect chiller) [75], while the COP for the adsorption chiller varies between 0.4 and 0.6 [71]. Pilatowsky et al. [72] discussed the various capacities of the different commercial systems of different manufacturers. Absorption and adsorption chillers are available in different capacities starting from 4.5 kW up to 30 MW depending on the manufacturer characteristics for the different systems [69,72].

Sorption cooling systems are energy source flexible systems as they could be driven by various energy sources, including solar energy. Low-

grade heat sources, such as waste heat, can also be used to power the sorption cooling systems [73,76]. Wang et al. [77] studied the LiBr-H₂O absorption cooling system's thermal performance using a Parabolic-trough collector. The study analysed how the steam flow rate affects the variations in the cooling capacity and COP. When the load factor changes from 20% to 100%, the COP increases from 0.89 to 1.32, which is the same for the absorption chiller driven by exhaust gas.

Heatwaves could decrease the cooling capacity and the efficiency of sorption cooling systems, Kim et al. [78] showed that the air-cooled half effect LiBr-water absorption chiller's cooling capacity in

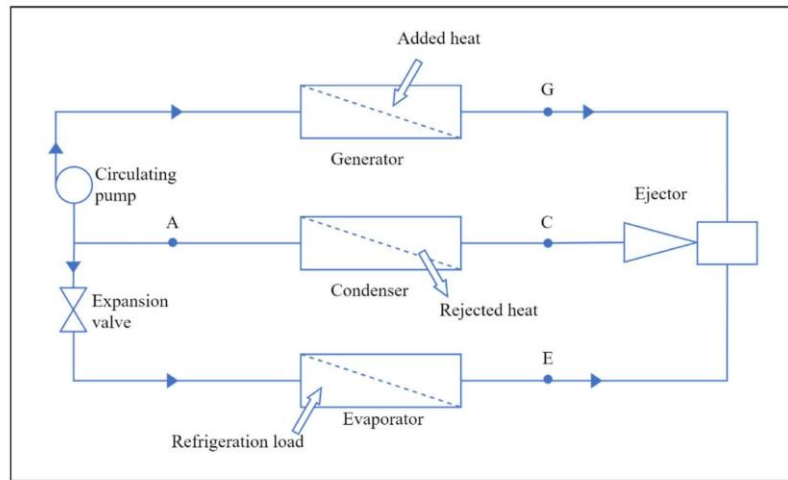

Fig. 9. Ejector cooling system Schematic Diagram.

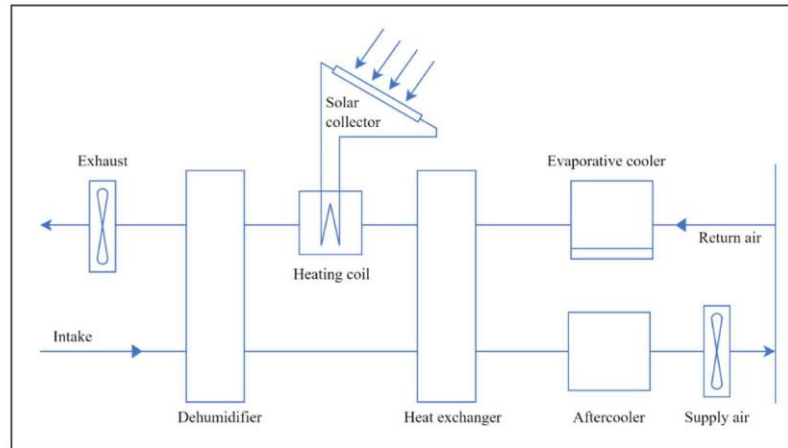

Fig. 10. Desiccant cooling system schematic diagram.

high-temperature conditions is 4.8 kW at 50 °C ambient temperature which is 62.5% lower than the cooling capacity at 35 °C ambient temperature (in case of the direct air-cooled chiller), while the cooling capacity for the indirect chiller at 50 °C ambient temperature is 3.2 kW (64.4% lower than the cooling capacity at 35 °C ambient). The cooling water distribution system of the sorption cooling systems, as well as a number of components inside the system, cannot be operated without an electrical power source, as a result, the system has medium resilience in the event of a power outage [11]. Resilience could be improved by connecting the sorption cooling system with solar systems like the assisted solar-absorption cooling systems where the electricity is provided by solar energy as electricity consumption (in kW_e per kW_{th} of cooling capacity) is much lower than for a conventional VC chiller. The sorption systems could also integrate local electricity production like the conventional compression refrigeration systems to operate during power outages [11].

In the past, there have been major manufacturers offering sorption cooling systems mainly for high capacities for commercial buildings and industrial applications. Currently, many companies developed chillers of medium and small capacities, therefore sorption cooling systems can be categorized in TRL of 3–9 [72,79].

4.2.2. Ejector cooling systems

The schematic diagram of the ejector cooling system is shown in Fig. 9. The cycle consists of an evaporator, a generator, an ejector, a condenser, an expansion valve and a circulation pump. The generator uses low-grade heat energy for vaporization, then, the high-pressure vapour (primary flow), enters the nozzle of the ejector and entrains low-pressure vapour from the evaporator (secondary flow). Both flows are mixed and undergo pressure increase in the ejector diffuser. They are then fed into the condenser. At the condenser outlet, the liquid is divided into two flows: the primary flow and the secondary flow. The secondary flow goes through the expansion device to the evaporator producing the refrigerating effect, while the primary flow is pumped back to the generator which completes the cycle [80,81]. The ejector can be used as a component of a refrigeration system, where it fulfils the role of a compressor [81].

The main advantage of the ejector is that it has no rotating component for compression or any other part that could require maintenance or lubrication. However, there are losses resulting from the direct interaction of two fluids moving at various velocities [81].

Those systems can be driven by low-grade thermal energy and enable the reduction of mechanical work requirements since the work of the pump can be neglected compared to the generator heat input [80,82].

The heat rejected at the condenser can be recovered to perform simultaneous heating and cooling, given that heat should be delivered at a lower temperature range (medium-temperature heat sink) than the generator heat (high-temperature heat source).

Ejector refrigeration systems are characterized by relatively low COP. Chen et al. [82] reported EERs ranging from 0.03 to 0.48 for cooling capacities up to 5 kW. Besagni et al. [83] presented a comprehensive literature review on ejector refrigeration systems. They provided a deep analysis of existing ejector technologies and their influence on ejector performance. Over more than 30 studies on ejector refrigeration systems, it appears that the EER varies within the range of 0.02–0.85.

The generator of the refrigeration cycle can be fed by various heat sources. Ejector refrigeration systems can be coupled with solar heating. The main advantage of solar energy is the temporal coincidence between heat input and cooling load. However, the solar collector should preferably be combined with TES due to the intermittent feature of solar energy [82]. Most of the studies concluded that the efficiency of an ejector system would be enhanced in a region with sufficient solar radiation but where a low condenser temperature could be maintained. The overall COP of the solar ejector refrigeration cycle can be expressed as equation (4) [80].

$$COP_{overall} = \eta_{solar\ panel} COP_{ejector\ chiller} \quad (4)$$

Therefore, the solar collector determines the solar-powered system's performance and cooling capability. Advanced refrigeration systems can be developed by completely removing the mechanical pump to realize heat-driven refrigeration systems [84]. Nguyen et al. [85] studied the possibility to use gravitational force to transfer the refrigerant from the condenser to the generator. Shen et al. [86] proposed replacing the mechanical pump with a gas-liquid ejector. Removing completely the mechanical pump would also ensure the resilience of the system as it would not be affected by power outages. Regarding the resilience to heatwaves, the system is dependent on the variability of the conditions at the condenser. The condenser temperature should be kept low enough to ensure system performance.

Due to their rather low EER, ejector refrigeration cycles are not competitive on the market yet due to high costs compared to absorption chillers. Ejector refrigeration systems may become a competitive technology only with higher EERs, which would lead to a reduction of heat exchanger size, hence decreased costs. The main advantages of this refrigeration system are robust operation, low cost and environmental safety [87]. So far, the TRL of ejector systems is 3 [88].

4.2.3. Desiccant systems

Desiccant cooling systems are heat-driven systems that can be used alternatively to conventional VC and sorption cooling systems. They can handle sensible and latent heat loads independently. A desiccant is a substance, either solid or liquid, which absorbs water molecules from warm humid air. The desiccant is later regenerated by heating so that it releases the absorbed moisture [89].

The underlying principle of desiccant cooling systems is to handle latent and sensible loads separately for more efficiency. The latent load of the process air (i.e., moisture) is removed in a dehumidifier that contains a desiccant material. Then, the sensible load can be handled by heat exchangers, evaporative coolers or cooling coils, in which the temperature of the dried process air is decreased to the desired comfort conditions [90]. For the system to work continuously, the desiccant should be regenerated using a heat supply. The regeneration process only requires low-grade heat at about 60–95 °C. Therefore, waste heat from traditional fossil-fuel systems and renewable energies like solar and geothermal heat are potential energy sources for regeneration. However, the desiccant system can also be coupled with an auxiliary heat source such as electricity or a gas heater if the continuous operation of the system is to be ensured [91]. The schematic diagram of the

desiccant system is shown in Fig. 10. If necessary, the air is further cooled in an evaporative air cooler (aftercooler), before being directed into the room.

The system is simple and generally has a satisfactory thermal coefficient of performance. Sahlot & Riffat [92] showed that liquid desiccant systems and solar-assisted desiccant cooling systems have EERs in the range of 0.47–1.38 in different regions [93–96]. Liquid desiccant systems can be used in conjunction with direct or indirect evaporative cooling systems or conventional VC systems since they are suited for latent heat extraction but not sensible heat [97]. Liquid desiccant systems can also be coupled with VC systems, offering the possibility to control temperature and humidity independently. Peña et al. [98] showed that such a system can reach an EER of 4.6. A novel design of a hybrid system of VC system and liquid desiccant system was proposed by She et al. [99]. In this system, the desiccant solution is regenerated using the condensing heat of the VC system. Generally, hybrid VC refrigeration systems show significantly higher EER than conventional VC refrigeration systems. The COP could be increased by up to 18%. Romero-Lara et al. [100] established a comparison between three air-cooling systems in which it appears that desiccant cooling systems consume from three to fifteen times less energy than a conventional VC system depending on the climate zone. Regarding environmental impact, they concluded that desiccant systems could be an alternative to traditional VC systems to reduce CO₂ emissions by 68–78% in the warmest zones.

Desiccant cooling systems are very flexible to energy sources. Since only low-temperature heat is required, the desiccant system can be coupled with a solar system or a geothermal system or by recycling the waste heat from another process. The heat production system can be combined with thermal storage to adapt to the building's needs without requiring the use of a gas heater or electricity [101].

They are not very robust to climate change since their efficiency strongly depends on outdoor air conditions. Moreover, the system requires electricity to drive the fans and pumps, meaning that it is not resilient in case of a power outage. Resilience could be improved by connecting the desiccant cooling system to a microgrid in which electricity is produced by solar panels.

Desiccator wheels are mainly used in non-residential applications, also they can also be used in residential buildings. However, the existing desiccant systems are generally simple with basic equipment and more advanced systems are not widely implemented yet [63]. Desiccant cooling technology could be categorized in TRL level of 3–4 [102].

a Solid desiccant system

In solid-assisted desiccant systems, solid desiccant materials are used to remove the air moisture content in the air through the adsorption process. The advantage of solid desiccant systems over liquid ones is the simpler handling of desiccant materials. Solid desiccants are also compact, less subject to corrosion and carryover [102]. However, solid desiccant materials generally have a higher regeneration temperature than liquid desiccants. Research is carried out to lower the regeneration temperature requirement [103].

b Liquid desiccant system

Liquid desiccants have several advantages over solid desiccants. Liquid desiccants are generally associated with lower-pressure drops, which makes them suitable to use with low-temperature regeneration [104]. The liquid desiccant can also be stored when a heat source is not available for regeneration. A liquid desiccant system combined with a VC system can reduce power consumption by 25% and condensation and evaporation areas by 34%, compared with a VC system alone [89].

5. Comparison between different active cooling systems

Table 2
Qualitative comparison between active cooling systems based on the assessment criteria.

Performance measures		AC Systems																															
		Electricity- Driven AC units (VC)													Thermal Energy-Driven AC Units																		
		Producing cold air									Producing chilled water (Chillers)				Sorpton Chiller			Ejector				Desiccant Systems											
		Split systems			Packaged Units			Air-cooled chillers			Water-cooled chillers				Evaporative cooled chillers	Adsorption Chiller	Absorption Chiller	Liquid Desiccant		Solid Desiccant													
Mono-split systems	Ductless systems	Ducted systems	Multi-split systems	Ductless systems	Ducted systems	VRF	3-pipe system	2-pipe system	Window Unit	Portable Unit	Rooftop Unit	Dry cooler	Wet cooling tower	Geothermal borehole	ATES	Large	Medium	Small	Large	Medium	Small	Large	Medium	Small	Large	Medium	Small	Large	Medium	Small			
Technical details	REV ¹	✓	✓	✓	✓	✓	✓	✓	✓	✓	✓	✓	✓	✓	✓	✓	✓	✓	✓	✓	✓	✓	✓	✓	✓	✓	✓	✓	✓	✓	✓	✓	
	REC ²	✓	✓	✓	✓	✓	✓	✓	✓	✓	✓	✓	✓	✓	✓	✓	✓	✓	✓	✓	✓	✓	✓	✓	✓	✓	✓	✓	✓	✓	✓	✓	
	PAS ³	✓	✓	✓	✓	✓	✓	✓	✓	✓	✓	✓	✓	✓	✓	✓	✓	✓	✓	✓	✓	✓	✓	✓	✓	✓	✓	✓	✓	✓	✓	✓	
System capacity range		Large	Large	Large	Large	Large	Large	Large	Low	Medium	Large	Large	Large	Large	Large	Large	Large	Large	Low	Medium	Large	Large	Large	Large	Large	Large	Large	Large	Large	Large	Large	Large	
Assessment Criteria																																	
Energy performance	System Efficiency	High	High	High	High	High	High	High	High	High	High	High	High	High	High	High	High	High	High	High	High	High	High	High	High	High	High	High	High	High	High	High	
Flexibility of the system	Energy source	High	High	High	High	High	High	High	High	High	High	High	High	High	High	High	High	High	High	High	High	High	High	High	High	High	High	High	High	High	High	High	
	Flexibility integration with secondary systems	Medium	Medium	Medium	Medium	Medium	Medium	Medium	Medium	Medium	Medium	Medium	Medium	Medium	Medium	Medium	Medium	Medium	Medium	Medium	Medium	Medium	Medium	Medium	Medium	Medium	Medium	Medium	Medium	Medium	Medium	Medium	
Climate resilience	Heatwaves	High	High	High	High	High	High	High	High	High	High	High	High	High	High	High	High	High	High	High	High	High	High	High	High	High	High	High	High	High	High	High	High
	Power outages	Low	Low	Low	Low	Low	Low	Low	Low	Low	Low	Low	Low	Low	Low	Low	Low	Low	Low	Low	Low	Low	Low	Low	Low	Low	Low	Low	Low	Low	Low	Low	Low
Other	Building type	All types	All types	All types	All types	All types	Larger buildings	Larger buildings	Residential	All types	Large buildings	All types	Large office buildings	All types	Large office buildings	All types	All types	All types	All types	All types	All types	All types	All types	All types	All types	All types	All types	All types	All types	All types	All types	All types	
	TTL	9	9	9	9	9	9	9	9	9	9	9	9	9	9	9	9	9	9	9	9	9	9	9	9	9	9	9	9	9	9	9	9

¹REV: Possibility to reverse the machine to work as a heat pump.

²REC: Possibility to recover heat at condenser (simultaneous heating and cooling).

³PAS: Possibility to make passive cooling.

6. Discussion

6.1. Findings and recommendations

According to the sixth assessment report of the Intergovernmental Panel on Climate Change (IPCC) [105], recurring heatwaves are becoming increasingly frequent. At the same time, buildings should be equipped with resilient cooling technologies to tackle the upcoming heatwaves. In this paper, ACs are classified into two main categories (electricity-driven and thermal energy-driven) cooling systems, with an overall assessment of 20 cooling systems as shown in Fig. 2. Electricity-driven systems are classified into systems producing cold air (split systems and packaged units) and systems producing cold water (air-cooled, water-cooled, and evaporative-cooled) chillers. Thermal energy-driven systems are classified into sorption systems, ejector cooling systems and desiccant systems. As shown in Fig. 1, cooling systems are qualitatively assessed through five assessment criteria (energy performance, flexibility to energy source and secondary systems, climate resilience to heatwaves and power outages, as well as building typology, and TRL). Furthermore, the prospect of reversing the machine to operate as a heat pump, recovering heat at the condenser, and operating in passive cooling mode is also studied.

Table 2 summarizes the results, it can be found that most electricity-driven systems can reverse the machine and work as a heat pump to work in heating mode except for the dry cooler and wet cooling tower. While only adsorption and absorption systems from thermal energy-driven systems can be reversed. Most of the systems cannot recover heat at the condenser except for 3-pipe VRF systems, water-cooled chillers, absorption systems, adsorption systems, and ejector cooling systems. Furthermore, air-cooled chillers and water-cooled chillers are the only systems that can work in passive cooling mode. The results also have shown that most of the systems are available in low, medium, and large capacities except for window units and ejector cooling systems that have low capacities, and portable units that have medium capacities. The efficiency for most of the systems is high as mostly all the conventional VC systems are available in the market with high efficiency, as well as; desiccant cooling systems [106,107], while sorption chiller and ejector cooling systems have lower efficiency levels compared to conventional VC systems.

Electricity-driven systems lack high flexibility with different energy sources. Therefore, they have either low or medium grades as shown in Table 2, based on the system flexibility to be driven by PV systems and renewable energy sources. On one hand, thermal energy-driven systems are energy source flexible systems and can be driven by various thermal energy sources as shown for sorption chillers, ejector cooling systems and desiccant systems. On the other hand, not all electricity-driven systems are highly integrated with secondary systems, only chillers are very flexible regarding integration with secondary systems (e.g., FCU and radiant panels). For thermal energy-driven systems, several applications show high flexibility with integration between ejector cooling systems, desiccant systems, and secondary systems which is not the case for sorption cooling systems.

Climate resilience to heatwaves is assessed according to the system's integration with renewable energy sources (specifically PV systems with batteries as well as biomass), and secondary systems. The results show that split systems and chillers are highly resilient to heatwaves, while the other electricity-driven systems are not very robust against heatwaves. In addition, air-cooled chillers and dry coolers are more sensitive to the outdoor temperature, therefore, they are less resilient to heatwaves than water-cooled chillers. The efficiency and capacity of thermal energy-driven systems are highly dependent on the outdoor temperature more than VC systems. Therefore, they are not strongly resilient to heatwaves, while for sorption systems, a previous study has shown that using a spray-evaporative heat exchanger can reduce the effect of the outdoor temperature on the sorption system capacity [108].

Electricity-driven systems are vulnerable to power outages due to

their dependency on electricity; therefore, they show low resilience to power outages. However, water-cooled chillers can work in passive mode (free chilling/geocooling). Therefore, they are more resilient to power outages than other electricity-driven systems. Sorption systems and desiccant systems have higher resilience grades to power outages compared to electricity-driven systems; due to the small electrical input to run the systems, while ejector cooling systems show high resilient to power outages as an advanced system could be operated without a mechanical pump [84].

Table 2 also shows the building type for the different cooling systems, as well as; their TRL. Most of the systems can be used in all building types except VRF systems, rooftop units, wet cooling towers and ATEs that are used in larger buildings, and window units that can be used in residential buildings only. All the electricity-driven systems are widely available and have a TRL of 9. Thermal energy-driven systems have a lower TRL between 3 and 4 and it could reach 9 in absorption and adsorption systems.

The list below is given as a summary of the main findings and recommendations.

1. Electricity-driven cooling systems are generally more mature technologies than thermal energy-driven cooling systems and they have higher efficiencies. They can also easily be coupled with renewable energy sources such as PV panels. Most electricity-driven systems also exist in reversible modes, such as they can provide cooling in summer and heating in winter.
2. Under some conditions, systems producing chilled water can be used to perform free chilling, leading to a considerable amount of energy saving. Such operating mode largely decreases electricity consumption making it more resilient to power outages.
3. Cooling systems coupled with mechanical ventilation systems grant improving both indoor air quality and energy savings. Generally, they are better suited for newly constructed residential buildings.
4. Thermal energy-driven AC units should be preferentially used in buildings in which some processes induce waste heat. They can also easily be coupled with renewable energy sources, e.g., solar thermal collectors or biomass combustion.

6.2. Strengths and limitations

Through a qualitative approach, this study evaluates the performance of several ACs based on a multi-criteria assessment. This section highlights the strength and limitations that were encountered by using a qualitative approach.

The original strengths of this study are fourfold. First, the performances of the ACs take into account their flexibility to integrate with renewable energy sources and secondary systems. The integration between the different systems is provided in original schematics in this study. Second, the study assesses the possibility of the cooling systems operating, in reverse mode, as a heat pump, the possibility to recover heat at the condenser (simultaneous heating and cooling), and the possibility to operate in passive cooling mode. Third, the study has been conducted on a wide range of technologies, applied to an extended range of cooling capacities and building types. Lastly, this study can be considered a part of the assessment of the different electricity-driven and thermal energy-driven cooling systems; which gives an overview of the most common types on the market.

However, the study has some limitations. First, the amount of literature discussing the resilience of ACs to heatwaves or power outages is rather limited. Generally, research is more focused on studying the performance of ACs under normal operating conditions. However, this uniquely utilises the collection of a large database to evaluate the systems' performances. For each system, the range of EER or COP that is given is resulting from a comparison of more than 30 systems.

The second limitation lies in the comparison between the performances of the different systems. All the systems have not necessarily

been tested using the same boundary conditions or in the same climate, they can also have different capacities for several building types and have different operating conditions. All those parameters make the direct comparison between the systems more complex. Finally, the parameters that have been chosen to compare the ACs are oriented toward climate change mitigation, some other parameters could also have been taken into account to characterize performance measurement that could have advantaged some other systems. In addition, some of the criteria chosen can sometimes be subjective regarding the evaluation (low, moderate or high) and influenced by the comparison with the other systems.

6.3. Future directions

Based on the critical review of the prior studies, a concrete comparison of different cooling systems based on multiple assessment criteria under the same boundary conditions remains challenging. The future directions should be able to consider both challenges and opportunities related to building site and location. For example, it could be an opportunity for one site to provide a water source for heat pumps, while another site has a main gas supply. Another direction should be to the probabilistic changes that are likely to occur in the future with the decision-making process in the different countries, for example, decarbonization of the electrical supply and the energy transitions.

7. Conclusion

This paper provides a qualitative assessment review to classify and assess ACs based on multi-assessment criteria. The study classified the cooling systems based on the energy source into electricity-driven cooling systems and thermal energy-driven cooling systems. The assessment criteria discussed for each cooling technology are the energy performance of the system, the flexibility of the system to energy sources and secondary systems, climate resilience to heatwaves and power outages, and the last parameter is related to the building type and TRL.

The results show that thermal energy-driven systems still lack the technological maturity of electricity-driven systems and are not ready to compete in the market now. Most typical VC systems are available in the market with high efficiency, as well as desiccant cooling systems. While sorption systems and ejector cooling systems have lower efficiency than conventional VC systems. Instead, thermal energy-driven systems are more flexible to be driven by different energy sources, and due to their low electrical input, they are more resilient to power outages. The study also found that only air-cooled and water-cooled chillers are capable of passive cooling operation. Additionally, dry coolers and air-cooled chillers are less resistant to heatwaves than other chillers due to their high sensitivity to outdoor temperatures. The strengths and limitations of the study are concluded in section 6.2 which shows that the paper's strengths rely on discussing the integration with renewable energies and secondary systems including original schematics showing the integration, investigating the reversibility, recovery, and passivity of each system and finally the assessment and comparison for more than 20 cooling systems. However, the study has some limitations due to the fact that limited data sources discuss the resilience of cooling systems to heatwaves and power outages. In addition, the boundary conditions used to discuss each system are not the same in this review, which requires future directions to take into account a quantitative assessment of the same boundary conditions to compare the different systems.

Declaration of competing interest

The authors declare that they have no known competing financial interests or personal relationships that could have appeared to influence the work reported in this paper.

Data availability

No data was used for the research described in the article.

Acknowledgment

This research was partially funded by the Walloon Region under the call 'Actions de Recherche Concertées 2019 (ARC)' (funding number: ARC 19/23-05) and the project OCCuPANT, on the Impacts Of Climate Change on the indoor environmental and energy PerformAnce of buildinGs in Belgium during summer. The authors would like to gratefully acknowledge the Walloon Region and Liege University for funding. This study is a part of the International Energy Agency (IEA) EBC Annex 80 – "Resilient cooling of buildings" project activities to define resilient cooling in residential buildings.

References

- [1] Climate change 2021: the physical science basis. Contribution of working group I to the sixth assessment report of the intergovernmental panel on climate change. Cambridge University Press; 2021. https://report.ipcc.ch/ar6/wg1/IPCC_AR6_WGI_FullReport.pdf.
- [2] Eyring V, Bony S, Meehl GA, Senior CA, Stevens B, Stouffer RJ, Taylor KE. Overview of the coupled model intercomparison project phase 6 (CMIP6) experimental design and organization. *Geosci Model Dev (GMD)* 2016;9:1937. <https://doi.org/10.5194/gmd-9-1937-2016>. –1958.
- [3] Okpalike C, Okeke FO, Ezema EC, Oforji PI, Igwe AE. Effects of renovation on ventilation and energy saving in residential building. *Civil Engineering Journal* 2022;7:124–34. <https://doi.org/10.28991/CEJ-SP2021-07-09>.
- [4] Elnagar E, Köhler B. Reduction of the energy demand with passive approaches in multifamily nearly zero-energy buildings under different climate conditions. *Front Energy Res* 2020;8:224. <https://doi.org/10.3389/fenrg.2020.545272>.
- [5] Vakiloroyaya V, Samali B, Fakhar A, Pishghadam K. A review of different strategies for HVAC energy saving. *Energy Convers Manag* 2014;77:738–54. <https://doi.org/10.1016/j.enconman.2013.10.023>.
- [6] IEA- International Energy Agency. The Future of Cooling- Opportunities for energy efficient air conditioning. 2018. <https://www.iea.org/reports/the-future-of-cooling>.
- [7] Kalkan N, Young EA, Celiktas A. Solar thermal air conditioning technology reducing the footprint of solar thermal air conditioning. *Renew Sustain Energy Rev* 2012;16:6352–83. <https://doi.org/10.1016/j.rser.2012.07.014>.
- [8] Labban O, Chen T, Ghoniem AF, Lienhard JH, Norford LK. Next-generation HVAC: prospects for and limitations of desiccant and membrane-based dehumidification and cooling. *Appl Energy* 2017;200:330–46. <https://doi.org/10.1016/j.apenergy.2017.05.051>.
- [9] Gado MG, Ookawara S, Nada S, El-Sharkawy II. Hybrid sorption-vapor compression cooling systems: a comprehensive overview. *Renew Sustain Energy Rev* 2021;143:110912. <https://doi.org/10.1016/j.rser.2021.110912>.
- [10] Best R, Rivera W. A review of thermal cooling systems. *Appl Therm Eng* 2015;75:1162–75. <https://doi.org/10.1016/j.applthermaleng.2014.08.018>.
- [11] Zhang C, Kazanci OB, Levinson R, Heiselberg P, Olesen BW, Chiesa G, Sodagar B, Ai Z, Selkowitz S, Zinzi M, Mahdavi A, Teufel H, Kolokotroni M, Salvati A, Bozonnet E, Chtioui F, Salagnac P, Rahif R, Attia S, Lemort V, Elnagar E, Breesch H, Sengupta A, Wang LL, Qi D, Stern P, Yoon N, Bogatu D-I, Rupp RF, Arghand T, Javed S, Akander J, Hayati A, Cehlin M, Sayadi S, Forghani S, Zhang H, Arens E, Zhang G. Resilient cooling strategies – a critical review and qualitative assessment. *Energy Build* 2021;251:111312. <https://doi.org/10.1016/j.enbuild.2021.111312>.
- [12] Ding G. Recent developments in simulation techniques for vapour-compression refrigeration systems. *Int J Refrig* 2007;30:1119–33. <https://doi.org/10.1016/j.ijrefrig.2007.02.001>.
- [13] Barbosa JR, Ribeiro GB, de Oliveira PA. A state-of-the-art review of compact vapor compression refrigeration systems and their applications. *Heat Tran Eng* 2012;33:356–74. <https://doi.org/10.1080/01457632.2012.613275>.
- [14] Eicker U, Pietruschka D, Haag M, Schmitt A. Systematic design and analysis of solar thermal cooling systems in different climates. *Renew Energy* 2015;80:827–36. <https://doi.org/10.1016/j.renene.2015.02.019>.
- [15] Allouhi A, Kouskou T, Jamil A, Bruel P, Mourad Y, Zeraouli Y. Solar driven cooling systems: an updated review. *Renew Sustain Energy Rev* 2015;44:159–81. <https://doi.org/10.1016/j.rser.2014.12.014>.
- [16] Eicker U, Pietruschka D, Schmitt A, Haag M. Comparison of photovoltaic and solar thermal cooling systems for office buildings in different climates. *Sol Energy* 2015;118:243–55. <https://doi.org/10.1016/j.solener.2015.05.018>.
- [17] Pezzutto S, Quaglini G, Riviere P, Kranzl L, Novelli A, Zambito A, Wilczynski E. Screening of cooling technologies in Europe: alternatives to vapour compression and possible market developments. *Sustainability* 2022;14:2971. <https://doi.org/10.3390/su14052971>.
- [18] Pezzutto S, Fazeli R, De Felice M, Sparber W. Future development of the air-conditioning market in Europe: an outlook until 2020: future development of the AC market in Europe. *WIREs Energy Environ* 2016;5:649–69. <https://doi.org/10.1002/wene.210>.

- [19] Steven Brown J, Domanski PA. Review of alternative cooling technologies. *Appl Therm Eng* 2014;64:252–62. <https://doi.org/10.1016/j.applthermaleng.2013.12.014>.
- [20] Hughes BR, Chaudhry HN, Ghani SA. A review of sustainable cooling technologies in buildings. *Renew Sustain Energy Rev* 2011;15:3112–20. <https://doi.org/10.1016/j.rser.2011.03.032>.
- [21] Oropeza-Perez I, Østergaard PA. Active and passive cooling methods for dwellings: a review. *Renew Sustain Energy Rev* 2018;82:531–44. <https://doi.org/10.1016/j.rser.2017.09.059>.
- [22] Kojok F, Fardoun F, Younes R, Outbib R. Hybrid cooling systems: a review and an optimized selection scheme. *Renew Sustain Energy Rev* 2016;65:57–80. <https://doi.org/10.1016/j.rser.2016.06.092>.
- [23] Bataine K, Taamneh Y. Review and recent improvements of solar sorption cooling systems. *Energy Build* 2016;128:22–37. <https://doi.org/10.1016/j.enbuild.2016.06.075>.
- [24] European Union, Commission Delegated Regulation (EU). No 626/2011 of 4 May 2011 supplementing Directive 2010/30/EU of the European Parliament and of the Council with regard to energy labelling of air conditioners. 2011. http://data.europa.eu/eli/reg_del/2011/626/oj.
- [25] Attia S, Levinson R, Ndong E, Holzer P, Berk Kazanci O, Homaei S, Zhang C, Olesen BW, Qi D, Hamdy M, Heiselberg P. Resilient cooling of buildings to protect against heat waves and power outages: key concepts and definition. *Energy Build* 2021;239:110869. <https://doi.org/10.1016/j.enbuild.2021.110869>.
- [26] World Meteorological Organization. <https://public.wmo.int/en>. [Accessed 17 May 2022].
- [27] U.S. Department of Energy. Technology readiness assessment Guide — DOE directives, guidance, and delegations. 2011. <https://www.directives.doe.gov/directives-documents/400-series/0413.3-EGuide-04a>. [Accessed 23 August 2021].
- [28] European Commission, Directorate-General for Energy, Pezzutto S, Novelli A, Zambito A, Quaglini G, Miraglio P, Belleri A, Bottecchia L, Gantioler S, Moser D, Riviere P, Etienne A, Stabat P, Berthou T, Kranzl L, Mascherbauer P, Fallahnejad M, Viegand J, Jensen C, Hummel M, Müller A. Cooling technologies overview and market shares. Part 1 of the study “Renewable cooling under the revised Renewable Energy Directive ENER/C1/2018-493. Publications Office of the European Union; 2022. <https://doi.org/10.2833/799633>.
- [29] Roth K, Westphalen D, Brodrick J. Ductless split systems, emerging technologies. 2006.
- [30] Bertagnolio S, Stabat P, Caciolo M, Corgier D. IEA-ECBCS annex 48 - review of heat recovery and heat pumping solutions. 2011. https://www.iea-ecbc.org/Data/publications/EBC_Annex_48_Final_Report_R2.pdf.
- [31] Eurovent Certita Certification SAS. TECHNICAL certification rules of the eurovent certified performance mark, eurovent certita certification sas. Paris: FRANCE; 2021. <https://www.eurovent-certification.com/media/images/af0/164/af0164aac35ccae5faadeb6d70abb56325107358.pdf>.
- [32] Takeoka A, Fukuda Y, Suzuki M, Hasunuma M, Sakoguchi E, Tokizaki H, Kouzuma S, Waki M, Ohnishi M, Nakano S, Kuwano Y. Solar-powered air conditioner. *Prog Photovoltaics Res Appl* 1993;1:47–54. <https://doi.org/10.1002/pip.4670010107>.
- [33] Parker DS, Dunlop JP, Center FSE. Solar photovoltaic air conditioning of residential buildings. In: Proceedings of the 1994 summer study on energy efficiency in buildings; 1994. p. 10. <https://stars.library.ucf.edu/fsec/822>.
- [34] Ahmad J, Najam Ul Islam M, Sabir J. Performance evaluation and design considerations for a split air-conditioner with built-in thermal energy storage. *Build Serv Eng Technol* 2019;40:560–75. <https://doi.org/10.1177/0143624418818228>.
- [35] Wang J, Zhang Q, Yu Y. An advanced control of hybrid cooling technology for telecommunication base stations. *Energy Build* 2016;133:172–84. <https://doi.org/10.1016/j.enbuild.2016.08.090>.
- [36] Hajidavalloo E, Eghtedari H. Performance improvement of air-cooled refrigeration system by using evaporatively cooled air condenser. *Int J Refrig* 2010;33:982–8. <https://doi.org/10.1016/j.jirefrig.2010.02.001>.
- [37] Abdelaziz O, Shrestha SS, Munk JD, Linkous RL, Goetzler W, Guernsey M, Kassuga T. Alternative refrigerant evaluation for high-ambient-temperature environments: R-22 and R-410a alternatives for mini-split air conditioners, oak ridge national laboratory (ORNL). Building technologies research and integration center. BTRIC; 2015. <https://doi.org/10.2172/1223676>.
- [38] Hernandez AC, Fumo N. A review of variable refrigerant flow HVAC system components for residential application. *Int J Refrig* 2020;110:47–57. <https://doi.org/10.1016/j.jirefrig.2019.11.005>.
- [39] Adnot J, Rivière P, Marchio D, Holmstrom M, Naeslund J, Saba J, Becirspahic S, Lopes C, Blanco I, Pérez-Lombard L, Ortiz J, Papakonstantinou K, Doukas P, Joppolo C, Casale C, Benke G, Giraud D, Houdant N, Colomines F, Hitchin R. Energy efficiency and certification of central air conditioners. 2003.
- [40] Courtney S. REHVA journal 02/2014 - performance of variable refrigerant flow (VRF) systems. 2014. <https://www.rehva.eu/rehva-journal/chapter/performance-of-variable-refrigerant-flow-vrf-systems>. [Accessed 17 May 2022].
- [41] Qian M, Yan D, Hong T, Liu H. Operation and performance of VRF systems: mining a large-scale dataset. *Energy Build* 2021;230:110519. <https://doi.org/10.1016/j.enbuild.2020.110519>.
- [42] Xia J, Winandy E, Georges B, Lebrun J. Testing methodology for VRF systems. In: International refrigeration and air conditioning conference; 2002. <https://docs.lib.purdue.edu/iracc/542>.
- [43] Hundt GF, Trott AR, Welch TC. Chapter 13 - packaged units. In: *Refrigeration and air conditioning*. fourth ed. Butterworth-Heinemann; 2008. p. 168–76.
- [44] Faramarzi R, Coburn B, Sarhadian R, Mitchell S, Pierce R. Performance evaluation of rooftop air conditioning units at high ambient temperatures. 2004. <https://www.semanticscholar.org/paper/Performance-Evaluation-of-Rooftop-Air-Conditioning-Faramarzi-Coburn/b3f097d0114255bd386ee6a4fd0de1f3a3cd5fc>. [Accessed 9 May 2022].
- [45] Kung F, Deru M, Bonnema E. Evaluation framework and analyses for thermal energy storage integrated with packaged air conditioning. 2013. <https://doi.org/10.2172/1107465>.
- [46] Ananthanarayanan PN. Basic refrigeration and air conditioning. 1997. May 17, 2022. <https://www.bookdepository.com/Basic-Refrigeration-Air-Conditioning-P-N-Anathanarayanan/9780074620083>.
- [47] Vuarnoz D, Niederhäuser E-L, Torregrossa D, Gabioud D. On the necessity to integrate power flexibility in cooling systems. *J Phys: Conf. Ser.* 2019;1346:012009. <https://doi.org/10.1088/1742-6596/1346/1/012009>.
- [48] Rhee KN, Olesen BW, Kim KW. Ten questions about radiant heating and cooling systems. *Build Environ* 2017;112:367–81. <https://doi.org/10.1016/j.buildenv.2016.11.030>.
- [49] Chang CK, Fui SK, Bin NW, Azizan MH. In: Comparison of air-cooled chiller, water-cooled chiller and hybrid evaporative air-cooled chiller in Malaysia - a review. Cumberland, United States: International Journal of Arts & Sciences, International Journal of Arts and Sciences LLC; 2013. p. 337–55. May 17, 2022. <https://www.proquest.com/docview/1419026997/abstract/EADBA6BB32C147B8PQ/1>.
- [50] Wallonie energie SPW. Le Réactif n° 32 - juin 2002 : votre machine frigorifique fonctionne en hiver. Adoptez le free-chilling, n.d. <https://energie.wallonie.be/se/vlet/Repository/reactif-n-32.pdf?IDR=477>. [Accessed 5 January 2023].
- [51] Ashwood A, Bharathan D. Hybrid cooling systems for low-temperature geothermal power production. 2011. <https://doi.org/10.2172/1009690>.
- [52] Conradie AE, Kröger DG. Performance evaluation of dry-cooling systems for power plant applications. *Appl Therm Eng* 1996;16:219–32. [https://doi.org/10.1016/1359-4311\(95\)00068-2](https://doi.org/10.1016/1359-4311(95)00068-2).
- [53] Boulay RB, Cerha MJ, Massoudi M. Dry and hybrid condenser cooling design to maximize operating income. In: ASME 2005 power conference. Chicago, Illinois, USA: ASME; 2005. p. 167–75. <https://doi.org/10.1115/PWR2005-50225>.
- [54] Kröger DG. Air-cooled heat exchangers and cooling towers. 2002. <http://eoliss.net/Sample-Chapters/C08/E3-10-03-06.pdf>.
- [55] Jensen J-P, Conrad B, Schuetz U, Ullrich FR, Wanning A. Hybrid dry coolers in cooling systems of high energy physics accelerators. In: Proceedings of EPAC. Switzerland: Lucerne; 2004. <https://accelconf.web.cern.ch/e04/PAPERS/WEP LT065.PDF>.
- [56] Asvapoositkul W, Kuansathan M. Comparative evaluation of hybrid (dry/wet) cooling tower performance. *Appl Therm Eng* 2014;71:83–93. <https://doi.org/10.1016/j.applthermaleng.2014.06.023>.
- [57] Leeper SA. Wet cooling towers: rule-of-thumb design and simulation. 1981. <https://doi.org/10.2172/5281927>.
- [58] Sun J, Feng X, Wang Y. Cooling-water system optimisation with a novel two-step sequential method. *Appl Therm Eng* 2015;89:1006–13. <https://doi.org/10.1016/j.applthermaleng.2015.01.012>.
- [59] Bertagnolio S. Evidence-based model calibration for efficient building energy services. *ULiège - Université de Liège*; 2012. <https://orbi.uliege.be/handle/2268/125650>. [Accessed 22 December 2022].
- [60] Pontes RFF, Yamauchi WM, Silva EKG. Analysis of the effect of seasonal climate changes on cooling tower efficiency, and strategies for reducing cooling tower power consumption. *Appl Therm Eng* 2019;161:114148. <https://doi.org/10.1016/j.applthermaleng.2019.114148>.
- [61] Jiang Y, Xie X. Theoretical and testing performance of an innovative indirect evaporative chiller. *Sol Energy* 2010;84:2041–55. <https://doi.org/10.1016/j.solener.2010.09.012>.
- [62] Gehlin S. Borehole thermal energy storage. In: *Advances in ground-source heat pump systems*. Elsevier; 2016. p. 295–327. <https://doi.org/10.1016/B978-0-08-100311-4.00011-X>.
- [63] Reuss M. The use of borehole thermal energy storage systems. In: *Advances in thermal energy storage systems*. Elsevier; 2021. p. 139–71. <https://doi.org/10.1016/B978-0-12-819885-8.00006-1>.
- [64] Diersch H-JG, Bauer D. Analysis, modeling, and simulation of underground thermal energy storage systems. In: *Advances in thermal energy storage systems*. Elsevier; 2021. p. 173–203. <https://doi.org/10.1016/B978-0-12-819885-8.00007-3>.
- [65] Nordell B, Snijders A, Stiles L. The use of aquifers as thermal energy storage (TES) systems. In: *Advances in thermal energy storage systems*. Elsevier; 2015. p. 87–115. <https://doi.org/10.1533/9781782420965.1.87>.
- [66] Youbi-Idrissi M, Macchi-Tejeda H, Fourmaison L, Guilpart J. Numerical model of sprayed air cooled condenser coupled to refrigerating system. *Energy Convers Manag* 2007;48:1943. <https://doi.org/10.1016/j.enconman.2007.01.025>. –1951.
- [67] Yu FW, Chan KT. Improved energy performance of air-cooled chiller system with mist pre-cooling. *Appl Therm Eng* 2011;31:537–44. <https://doi.org/10.1016/j.applthermaleng.2010.10.012>.
- [68] Henning H-M. Solar assisted air conditioning of buildings – an overview. *Appl Therm Eng* 2007;27:1734–49. <https://doi.org/10.1016/j.applthermaleng.2006.07.021>.
- [69] Kuehn A, Ziegler F, Dawoud B, Schossig P, Wien J, Critoph R. Thermally driven heat pumps for heating and cooling. 2013. <https://d-nb.info/1066160627/34>.
- [70] Román JC, Domínguez RJR, Martínez AR, Parra PS. Thermal analysis of an absorption and adsorption cooling chillers using a modulating tempering valve. *IntechOpen*; 2019. <https://doi.org/10.5772/intechopen.84737>.

- [71] Kuczyńska A, Szaflik W. Adsorption and adsorption chillers applied to air conditioning systems. *Arch Therm* 2010;31:77–94. <https://doi.org/10.2478/v10173-010-0010-0>.
- [72] Pilatowsky I, Romero RJ, Isaza CA, Gamboa SA, Sebastian PJ, Rivera W. Cogeneration fuel cell-sorption air conditioning systems. London: Springer London; 2011. <https://doi.org/10.1007/978-1-84996-028-1>.
- [73] Nikbakhti R, Wang X, Hussein AK, Iranmanesh A. Adsorption cooling systems – review of various techniques for energy performance enhancement. *Alex Eng J* 2020;59:707–38. <https://doi.org/10.1016/j.aej.2020.01.036>.
- [74] Almasri RA, Abu-Hamdeh NH, Esmail KK, Suyambazhahan S. Thermal solar sorption cooling systems - a review of principle, technology, and applications. *Alex Eng J* 2022;61:367–402. <https://doi.org/10.1016/j.aej.2021.06.005>.
- [75] Herold KE, Radermacher R, Klein SA. Adsorption chillers and heat pumps. 0 ed. CRC Press; 2016. <https://doi.org/10.1201/b19625>.
- [76] Wolak E. The cooling effect by adsorption-desorption cycles. *E3S Web Conf*. 2017;14:01052. <https://doi.org/10.1051/e3sconf/20171401052>.
- [77] Wang J, Yan R, Wang Z, Zhang X, Shi G. Thermal performance analysis of an adsorption cooling system based on parabolic trough solar collectors. *Energies* 2018;11:2679. <https://doi.org/10.3390/en11102679>.
- [78] Kim DS, Infante Ferreira CA. Air-cooled LiBr-water absorption chillers for solar air conditioning in extremely hot weathers. *Energy Convers Manag* 2009;50:1018–25. <https://doi.org/10.1016/j.enconman.2008.12.021>.
- [79] Stryi-Hipp G, Dias P, Ivancic A, Mugnier D, Weiss W. Solar heating and cooling technology roadmap. 2014. <https://doi.org/10.13140/2.1.3594.9764>.
- [80] Chen J, Havtun H, Palm B. Investigation of ejectors in refrigeration system: optimum performance evaluation and ejector area ratios perspectives. *Appl Therm Eng* 2014;64:182–91. <https://doi.org/10.1016/j.applthermaleng.2013.12.034>.
- [81] Grazzini G, Milazzo A, Mazzelli F. Ejectors for efficient refrigeration. Cham: Springer International Publishing; 2018. <https://doi.org/10.1007/978-3-319-75244-0>.
- [82] Chen X, Omer S, Worall M, Riffat S. Recent developments in ejector refrigeration technologies. *Renew Sustain Energy Rev* 2013;19:629–51. <https://doi.org/10.1016/j.rser.2012.11.028>.
- [83] Besagni G, Mereu R, Inzoli F. Ejector refrigeration: a comprehensive review. *Renew Sustain Energy Rev* 2016;53:373–407. <https://doi.org/10.1016/j.rser.2015.08.059>.
- [84] Chen J, Jarall S, Havtun H, Palm B. A review on versatile ejector applications in refrigeration systems. *Renew Sustain Energy Rev* 2015;49:67–90. <https://doi.org/10.1016/j.rser.2015.04.073>.
- [85] Nguyen VM, Riffat SB, Doherty PS. Development of a solar-powered passive ejector cooling system. *Appl Therm Eng* 2001;21:157–68. [https://doi.org/10.1016/S1359-4311\(00\)00032-6](https://doi.org/10.1016/S1359-4311(00)00032-6).
- [86] Shen S, Qu X, Zhang B, Riffat S, Gillott M. Study of a gas-liquid ejector and its application to a solar-powered bi-ejector refrigeration system. *Appl Therm Eng* 2005;25:2891–902. <https://doi.org/10.1016/j.applthermaleng.2005.02.012>.
- [87] Milazzo A, Mazzelli F. Future perspectives in ejector refrigeration. *Appl Therm Eng* 2017;121:344–50. <https://doi.org/10.1016/j.applthermaleng.2017.04.088>.
- [88] VHK, ARMINES, Viegand, Maagøe ApS (VM). Wuppertal Institute for climate, environment and energy GmbH, technology roadmap in preparatory/review study on commission regulation (EC) No. 643/2009 with regard to ecodesign requirements for household refrigeration appliances and commission delegated regulation (EU) No. 1060/2010 with regard to energy labelling. <http://www.ecodesign-fridges.eu/>; 2016.
- [89] Srivastav A. Performances studies for desiccant cooling system. In: *International research journal of engineering and technology. IRJET*; 2016. p. 405–8. <https://www.irjet.net/archives/V3/i4/IRJET-V3I480.pdf>.
- [90] Pesaran AA, Penney TR, Czanderna AW. Desiccant cooling: state-of-the-art assessment. National Renewable Energy Laboratory (U.S.); 1992. <https://digital.library.unt.edu/ark:/67531/metadc1187824/>. [Accessed 8 December 2022].
- [91] Ge TS, Xu JC. Review of solar-powered desiccant cooling systems. In: *Advances in solar heating and cooling*. Elsevier; 2016. p. 329–79. <https://doi.org/10.1016/B978-0-08-100301-5.00013-8>.
- [92] Sahlot M, Riffat SB. Desiccant cooling systems: a review. *Int J Low Carbon Technol* 2016. <https://doi.org/10.1093/ijlct/ctv032>.
- [93] Banyyounes AM, Liu G, Rasul MG, Khan MMK. Analysis of solar desiccant cooling system for an institutional building in subtropical Queensland, Australia. In: *Renewable and sustainable energy reviews*. Elsevier; 2012. p. 6423–31. <https://ideas.repec.org/a/eee/rensus/v16y2012i8p6423-6431.html>. [Accessed 9 December 2022].
- [94] Fong KF, Chow TT, Lin Z, Chan LS. Simulation-optimization of solar-assisted desiccant cooling system for subtropical Hong Kong. *Appl Therm Eng* 2010;30:220–8. <https://doi.org/10.1016/j.applthermaleng.2009.08.008>.
- [95] Gommed K, Grossman G. Experimental investigation of a liquid desiccant system for solar cooling and dehumidification. *Sol Energy* 2007;81:131–8. <https://doi.org/10.1016/j.solener.2006.05.006>.
- [96] Crofoot L, Harrison S. Performance evaluation of a liquid desiccant solar air conditioning system. *Energy Proc* 2012;30:542–50. <https://doi.org/10.1016/j.egypro.2012.11.064>.
- [97] Henning H-M, Erpenbeck T, Hindenburg C, Santamaria IS. The potential of solar energy use in desiccant cooling cycles. *Int J Refrig* 2001;24:220–9. [https://doi.org/10.1016/S0140-7007\(00\)0024-4](https://doi.org/10.1016/S0140-7007(00)0024-4).
- [98] Peña X, Alonso L, Diaz de Mendibil A, Prieto J, Gommed K. Hybrid liquid desiccant system design and operation under high latent load conditions in Taiwan. *Int J Refrig* 2019;105:41–9. <https://doi.org/10.1016/j.ijrefrig.2018.11.011>.
- [99] She X, Yin Y, Zhang X. Thermodynamic analysis of a novel energy-efficient refrigeration system subcooled by liquid desiccant dehumidification and evaporation. *Energy Convers Manag* 2014;78:286–96. <https://doi.org/10.1016/j.enconman.2013.10.057>.
- [100] Romero-Lara MJ, Comino F, Ruiz de Adana M. Seasonal analysis comparison of three air-cooling systems in terms of thermal comfort, air quality and energy consumption for school buildings in mediterranean climates. *Energies* 2021;14:4436. <https://doi.org/10.3390/en14154436>.
- [101] Kessling W, Laevemann E, Kapfhammer C. Energy storage for desiccant cooling systems component development. *Sol Energy* 1998;64:209–21. [https://doi.org/10.1016/S0038-092X\(98\)00081-4](https://doi.org/10.1016/S0038-092X(98)00081-4).
- [102] Daou K, Wang R, Xia Z. Desiccant cooling air conditioning: a review. *Renew Sustain Energy Rev* 2006;10:55–77. <https://doi.org/10.1016/j.rser.2004.09.010>.
- [103] Murya R, Shrivastav N, Shrivastava V. Performance and analysis of an evaporative cooling system: a review. In: *International journal of scientific & engineering research*; 2014. <https://www.ijser.org/researchpaper/Performance-and-Analysis-of-an-Evaporative-cooling-System-A-Review.pdf>.
- [104] Sarbu I, Sebarchievici C. Solar thermal-driven cooling systems. In: *Solar heating and cooling systems*. Elsevier; 2017. p. 241–313. <https://doi.org/10.1016/B978-0-12-811662-3.00007-4>.
- [105] Seneviratne S, Zhang X, Adnan M, Badi W. Weather and climate extreme events in a changing climate. In: *Climate change 2021: the physical science basis. Contribution of working group I to the sixth assessment report of the intergovernmental panel on climate change*; 2021. <https://www.ipcc.ch/report/ar6/wg1/chapter/chapter-11/>. [Accessed 19 December 2022].
- [106] Goetzler W, Corporate BTO, Shandross RA, Young JV, Petrichenko O, Ringo DFP, McClive S. Energy savings potential and RD&D opportunities for commercial building HVAC systems. 2017. <https://www.energy.gov/sites/prod/files/2017/12/f46/bto-DOE-Comm-HVAC-Report-12-21-17.pdf>.
- [107] Goetzler W, Zogg R, Young J, Johnson C. Alternatives to vapor-compression HVAC technology. *ASHRAE J* 2014;12–23. <https://ifair.org/en/fridoc/alternatives-to-vapor-compression-hvac-technology-138055>.
- [108] Grzebielec A, Laskowski R, Ruciński A. Influence of outside temperature on the operation of the adsorption chiller. In: *Proceedings of 10th international conference "environmental engineering," VGTU technika*. Lithuania: Vilnius Gediminas Technical University; 2017. <https://doi.org/10.3846/enviro.2017.255>.

Appendix C

Chapter 03: *Historical and future weather data for dynamic building simulations in Belgium using the regional climate model MAR: typical and extreme meteorological year and heatwaves.*



Historical and future weather data for dynamic building simulations in Belgium using the regional climate model MAR: typical and extreme meteorological year and heatwaves

Sébastien Doutreloup¹, Xavier Fettweis¹, Ramin Rahif², Essam Elnagar³, Mohsen S. Pourkiaei⁴, Deepak Amaripadath², and Shady Attia²

¹Laboratory of Climatology and Topoclimatology, Department de Geography, UR SPHERES, University of Liège, Liège 4000, Belgium

²Sustainable Building Design Lab, Dept. UEE, Faculty of Applied Sciences, University of Liège, Liège 4000, Belgium

³Thermodynamics Laboratory, Aerospace and Mechanical Engineering Department, Faculty of Applied Sciences, University of Liège, Liège 4000, Belgium

⁴Atmospheres and Monitoring lab (SAM), UR SPHERES, University of Liège, Arlon Campus Environment, Avenue de Longwy 185 6700 Arlon, Belgium

Correspondence: Sébastien Doutreloup (s.doutreloup@uliege.be)

Received: 9 November 2021 – Discussion started: 15 February 2022

Revised: 1 June 2022 – Accepted: 5 June 2022 – Published: 6 July 2022

Abstract. Increasing temperatures due to global warming will influence building, heating, and cooling practices. Therefore, this data set aims to provide formatted and adapted meteorological data for specific users who work in building design, architecture, building energy management systems, modelling renewable energy conversion systems, or others interested in this kind of projected weather data. These meteorological data are produced from the regional climate model MAR (Modèle Atmosphérique Régional in French) simulations. This regional model, adapted and validated over Belgium, is forced firstly, by the ERA5 reanalysis, which represents the closest climate to reality and secondly, by three Earth system models (ESMs) from the Sixth Coupled Model Intercomparison Project database, namely, BCC-CSM2-MR, MPI-ESM.1.2, and MIROC6. The main advantage of using the MAR model is that the generated weather data have a high resolution (hourly data and 5 km) and are spatially and temporally homogeneous. The generated weather data follow two protocols. On the one hand, the Typical Meteorological Year (TMY) and eXtreme Meteorological Year (XMY) files are generated largely inspired by the method proposed by the standard ISO15927-4, allowing the reconstruction of typical and extreme years, while keeping a plausible variability of the meteorological data. On the other hand, the heatwave event (HWE) meteorological data are generated according to a method used to detect the heatwave events and to classify them according to three criteria of the heatwave (the most intense, the longest duration, and the highest temperature). All generated weather data are freely available on the open online repository Zenodo (<https://doi.org/10.5281/zenodo.5606983>, Doutreloup and Fettweis, 2021) and these data are produced within the framework of the research project OCCuPANt (<https://www.occupant.uliege.be/> (last access: 24 June 2022) – ULiège).

1 Introduction

On a global scale, the warmest (SSP5-8.5) scenario from the IPCC last assessment report (IPCC, 2021) suggests a temperature increase of $+5^{\circ}\text{C}$ by 2100. However, the regions of the world will not warm up at the same speed or intensity. Some regions, such as the poles, will warm faster and to higher levels than equatorial regions (Lee et al., 2021). Over the temperate regions, such as western Europe, the temperature is expected to increase between $+1$ and $+5^{\circ}\text{C}$ in 2100, depending on the climate models and greenhouse gas emission scenarios used (Termonia et al., 2018; RMI, 2020; IPCC, 2021).

Moreover, IPCC (2021) affirm that extreme events will become more probable and more intense. In particular, the maximum temperature is expected to increase faster (sometimes up to twice) than the mean temperature (Seneviratne et al., 2021). Over western-central Europe, maximum temperatures are projected to increase up to $+7^{\circ}\text{C}$ for a global increase of $+5^{\circ}\text{C}$ (Seneviratne et al., 2021).

More concretely, in the summer, hot extremes (including heatwaves) are already increasing and will continue to strengthen with global warming, both in intensity and frequency (Suarez-Gutierrez et al., 2020; Seneviratne et al., 2021; Dunn et al., 2020). The consequences of these heatwaves will affect human health (Fouillet et al., 2006), agriculture, the comfort and health of life inside buildings (Bruffaerts et al., 2018; Sherwood and Huber, 2010; Buysse et al., 2010), and the energy demand, especially for cooling systems (Larsen et al., 2020). This is what motivated some previous studies in Belgium to represent the energy needs for heating and cooling under average and extreme weather conditions (Ramon et al., 2019).

Energy efficiency and living comfort are precisely what motivates the ULiège OCCuPANT project (Impacts Of Climate Change on the indoor environmental and energy Performance of buildINgs in Belgium during summer, <https://www.occupant.uliege.be/>, last access: 24 June 2022), in which climate data are involved. The OCCuPANT project aims to evaluate the energy performance and vulnerability of building inhabitants in the context of climate change. Acquiring reliable current and future climate data is vital in any study related to climate change and defines its quality (Pérez-Andreu and al., 2018).

The purpose of this data set is to propose meteorological data coming from a fine-resolution regional climate model over Belgium and neighbouring regions. These data will then be used to anticipate future climate changes, which will influence both the production of heating and cooling demands as well as the electrical grids on larger scales. These changes will require innovations in building design and systems, which will necessarily take time. Thus, the more they are anticipated, the better we will find solutions. The use of a regional model allows the building of spatially and temporally continuous and homogeneous past and future meteorological data, according to different warming scenarios for some Belgian cities.

This regional model is fed by the ERA-5 reanalysis model (Hersbach et al., 2020) to simulate the past climate (1980–2020), and also by three different Earth system models (ESMs) from the Sixth Coupled Model Intercomparison Project (CMIP6) database (Wu et al., 2019; Tatebe et al., 2019; Gutjahr et al., 2019) to obtain different future projections and associated uncertainties for the same scenario SSP5-8.5.

The future climate data are very useful to predict the variations in heating and cooling demands in buildings. The characterisation of a minimum outdoor temperature under future scenarios is necessary to estimate the heating and cooling season needs. This can result in rethinking building designs and making them resilient against the impact of climate change. For instance, in the heating-dominated region of Belgium, the concept of building design focuses more on heat retention to decrease heating energy use during the winter. However, warming weather conditions in the last decades meant that this design concept caused significant overheating problems during the summer. Therefore, it is necessary to predict the future performance of buildings and adapt them to the variations in outdoor weather conditions. Designing cooling systems that can last for 100 years is challenging. However, it is possible to increase the preparedness of buildings for climate change through passive design strategies, the use of active heating/cooling systems, or both. Both active and passive solutions may need regular replacements over the building's lifespan.

For each city, considered period, model, and scenario, two synthetic files (in CSV format) are generated, largely inspired by the method in ISO-15927-4. These are a Typical Meteorological Year (TMY) file and an eXtreme Meteorological Year (XMY) file. In addition to these synthetic files, files focused on heatwaves are also generated, namely, a file for the most intense heatwave event, one for the warmest heatwave, one for the longest heatwave, and one containing all the heatwaves detected within a specific period. These files are described in detail in the Methodology section.

2 Methodology

2.1 MAR model and area of interest

The regional climate model used in this study is the Modèle Atmosphérique Régional model (hereafter MAR) in its version 3.11.4 (Kittel, 2021). The main role of MAR is to down-scale a global model or reanalysis to get weather outputs at a finer spatial and temporal resolution (Fig. 1). As shown in Fig. 1, MAR is a 3-dimensional atmospheric model coupled to a 1-dimensional transfer scheme between the surface, vegetation, and atmosphere (Ridder and Gallée, 1998). The MAR model also includes an urban island module, which modifies the city grid points to simulate an urban heat island through a modification of the surface albedo (fixed to

0.1) and an absence of vegetation, which influence the thermal and humidity exchanges between soil and atmosphere. Initially, the MAR model was developed for both Greenland (Fettweis et al., 2013) and Antarctica ice sheets (Agosta et al., 2019; Kittel et al., 2021). However, it has recently been successfully adapted to temperate regions such as Belgium (Fettweis et al., 2017; Doutreloup et al., 2019; Wyard et al., 2021). In the framework of this study, MAR is initially forced every 6 h at its lateral boundaries (temperature, wind, and specific humidity) by the reanalysis ERA5 (hereafter called MAR-ERA5), which is available at a horizontal resolution of ~ 31 km (Hersbach et al., 2020). Different kinds of observations (in situ weather observations, radar data, satellites, etc.) are 6-hourly assimilated into ERA5 to be closest to the observed climate. In this way, the simulations of MAR-ERA5 can be considered as the closest simulation to the current observed climate.

Then, the MAR model has been forced every 6 h by three ESMs from the CMIP6 database (Eyring et al., 2016). These ESMs do not contain any observational data and represent only an evolution of the average and interannual variability of the climatic parameters over long periods. These models contain two characteristic periods: one in the past from 1980 to 2014 (hereafter called the “historical” scenario) and another in the future from 2015 to 2100 according to different SSP scenarios (SSP5-8.5, SSP3-7.0, and SSP2-4.5). The selection and description of each of these ESMs and a comparison with MAR-ERA5 over the historical period are presented in the next section.

The atmospheric variables used to force MAR every 6 h at each vertical level are temperature, surface pressure, wind, specific humidity, and the sea surface temperature over the North Sea from both ERA5 reanalysis (from 1980 to 2020) and the three ESMs (from 1980 to 2100). The spatial resolution of MAR is 5 km over an integration domain (120×90 grid cells) centred over Belgium, as shown in Fig. 2, to build hourly outputs.

The choice of 12 cities is motivated, on the one hand, by the size of the cities which must be sufficient to show a temperature increase compared to the neighbouring countryside and, on the other hand, to best represent the climate spatial variability observed in Belgium. For example, the city of Oostende is strongly influenced by the thermal inertia of the sea, while the city of Arlon has a more continental climate.

2.2 Forcing models and MAR simulations

2.2.1 Choice of representative Earth system models

The Sixth Coupled Model Intercomparison Project (CMIP6; Eyring et al., 2016) database contains about 30 ESMs from many scientific institutes around the world. For practical reasons, we cannot regionalise all these ESMs. Thus, we had to select a few representative ESMs for our region of interest, western Europe.

Our choice was based on two criteria. The first criterion is that the ESM should represent (with the lowest possible bias) the main atmospheric circulation in the free atmosphere over western Europe by evaluating the geopotential height at 500 hPa and the temperature at 700 hPa during summer and winter, with respect to ERA5 over 1980–2014 based on the skill score method developed by Connolley and Bracegirdle (2007). After selecting the ESMs that meet this first criterion, the second criterion is to choose three ESMs representing the CMIP6 models spread in 2100 for the same scenario (SSP5-8.5 here). Namely, we keep only three ESMs (see Table A1): BCC-CSM2-MR (Wu et al., 2019), MPI-ESM1.2 (Gutjahr et al., 2019), and MIROC6 (Tatebe et al., 2019). The ESM BCC-CSM2-MR simulates warming close to the ensemble mean of the 30 ESMs for the 2100 horizon using the SSP5-8.5 scenario, the ESM MIROC6 simulates larger warming than the ensemble mean, and the ESM MPI-ESM1.2 simulates lower warming than the ensemble mean by 2100. The use of these three models allows us to obtain a first approximation of the uncertainty from ESMs without having to downscale all 30 available models of CMIP6.

2.2.2 Future socio-economic scenarios

Shared Socio-economic Pathways (SSPs; Riahi et al., 2017) are scenarios of global socio-economic evolution projected to 2100. These SSPs are used to develop greenhouse gas (GHG) emission scenarios associated with different climate policies and are used to force each future ESM. There are three main scenarios, namely SSP2-4.5 (intermediate GHGs), SSP3-7.0 (high GHGs) and SSP5-8.5 (very high GHGs), causing global warming for 2100 to increase respectively. For more details about these scenarios, we refer to Riahi et al. (2017). Finally, it should be noted that the historical scenario mentioned in Sect. 2.1 is forced by the greenhouse gas concentrations observed over the period of 1980–2014.

For the same practical reasons that led us to choose only three ESMs out of the 30 available models, we cannot afford to calculate every SSP scenario of each ESM. However, as the ESMs cannot represent general circulation changes (Eyring et al., 2021), the use of one scenario or another will not cause more blocking anticyclones leading to more persistent heatwaves, for example. Thus, whichever scenario is used will only reflect temperature changes in relation to its GHG concentrations. Hence, only the SSP5-8.5 scenario has been calculated and the other scenarios (SSP3-7.0 and SSP2-4.5) are derived from the MAR simulations forced by the ESMs using the SSP5-8.5 scenario, since the warming rates from lower scenarios are included in the scenario SSP5-8.5, but for a different earlier time period. Thus, for each scenario (SSP3-7.0 and SSP2-4.5), the equivalent warming period in the SSP5-8.5 scenario has been found according to these three steps:

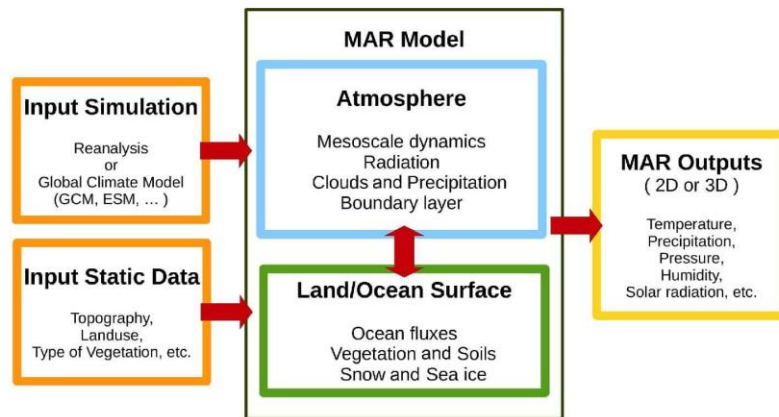

Figure 1. Workflow of the MAR model. The MAR model (black box) needs to be forced by a reanalysis model or global model (upper orange box) and by static data (lower orange box). The result of the MAR simulation gives meteorological variables in two or three dimensions (yellow box).

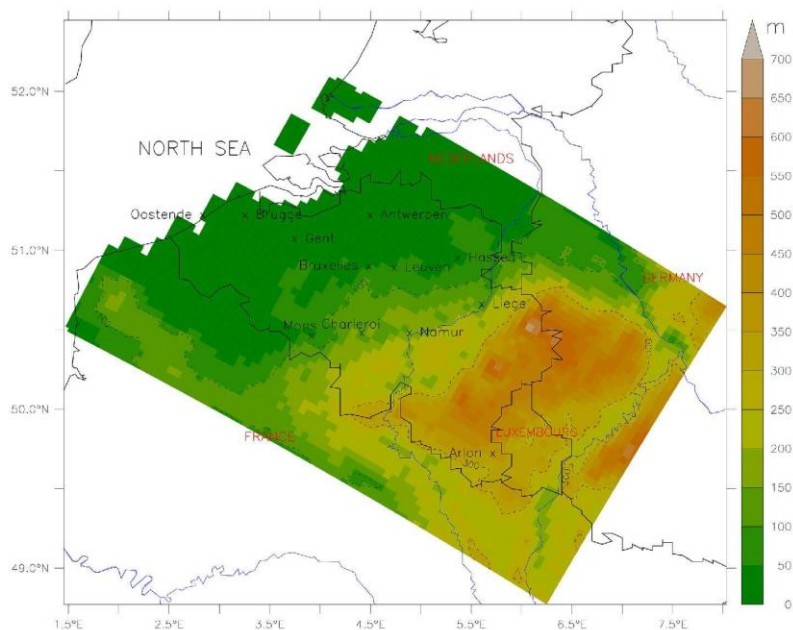

Figure 2. Model topography (colour background and dashed black line, both in metres above sea level), localisation of cities (black letters) used in this dataset for Belgium, and localisation of neighbouring countries (in red letters).

1. The raw 2 m annual mean temperature of each ESM and each scenario has been aggregated over Belgium to the horizon 2100.
2. For each ESM, the equivalent 20-year period from the SSP5-8.5 scenario has been chosen as the period with the closest mean and the closest interannual variability of the 2 m annual temperature, compared to the future 20-year period (i.e. 2021–2040, 2041–2060, ...) from the two other scenarios (SSP3-7.5 and SSP2-4.5).
3. Once the equivalent warming period has been identified, the data of this period are extracted out of the SSP5-8.5-forced MAR simulations for both SSP3-7.5 and SSP2-4.5 scenarios.

For example, the data of MAR-MPI for SSP3-7.0 over 2081–2100 are the outputs of MAR-MPI using SSP5-8.5 over the period 2066–2085.

This method is open to discussion for several reasons. Firstly, the climate does not react in a linear way to an increase of GHG flowing through the different SSP scenarios. Moreover, with an equal warming rate, but different periods, the earth, atmosphere and ocean systems will not have the same (spatial and temporal) responses due to their inertia. Despite these precautions, this methodology allows us, on the one hand, to derive a quick estimation without additional computer time. On the other hand, it remains valid as a first approximation, especially since the most interesting weather variable in this study is temperature, which is, by construction, the least sensitive to these issues.

2.2.3 Evaluation of the MAR simulations

To verify that these ESM-forced MAR simulations can be used to anticipate future periods, it is necessary to evaluate them over the overlapping period between the ERA5 reanalyses and the historical scenario (namely, 1980–2014). The aim is to determine if they can represent the average and climate variability over the Belgian territory for this period as observed (i.e. ERA5 in our case). So, we compare the three MAR simulations forced by the three ESMs with the MAR simulation forced by the ERA5 reanalyses. As the most important variable for this database is the temperature at 2 m above ground level (a.g.l.) and an important secondary variable is the incoming solar radiation, the mean and standard deviation of these data over the period 1980–2014 and over the Belgian territory are compared in Table 1 and Fig. 3. These values are compared on an annual scale and on a summer scale since the OCCuPANT project focuses on heat-waves.

The results of this comparison presented in Table 1 indicate that the incoming solar radiations and temperature at 2 m a.g.l. values proposed by the three MAR simulations forced by the ESMs are mostly close to the average simulated by MAR-ERA5, with (not statistically significant) biases between MAR forced by the ESMs and MAR-ERA5 lower than the standard deviation (i.e. the interannual variability) of MAR-ERA5. We can also note that the interannual variability of the MAR simulations forced by the ESMs is close to the interannual variability of the MAR-ERA5 simulation. We can then conclude that the MAR simulations forced by the ESMs can represent the mean climate simulated by MAR-ERA5 and its interannual variability with success, except MAR-MIR, which significantly overestimates temperature and solar radiation in summer. Knowing that MAR-MIR simulated the largest warming in 2100, this simulation needs to be considered as the extreme climate we could have.

2.3 Generating the Typical Meteorological Year and eXtreme Meteorological Year files

The Typical Meteorological Year (TMY) and the eXtreme Meteorological Year (XMY) are data sets that are widely used by building designers and others to model renewable energy conversion systems (Wilcox and Marion, 2008). The TMYs are the synthetic years (on an hourly basis) constructed by representative typical months (Barnaby and Crawley, 2011), which are selected by comparing the distribution of each month within the long-term (minimum of 10 years) distribution of that month for the available observations or modelled data (using Finkelstein–Schafer statistics (Finkelstein and Schafer, 1971)). The XMY is the extension of the TMY weather data and is formed by selecting the most deviating (i.e. extreme) months over a certain data set instead of typical months (Ferrari and Lee, 2008). There are many methods to reconstruct this kind of weather file (Ramon et al., 2019), but for this study, a protocol for the construction of these typical years has been developed based on the ISO15927-4 (European Standard, 2005) and is described briefly below.

The method consists of reconstituting each month of the typical (extreme) year with the most typical (extreme) month present in the considered period for a considered city. The comparison is essentially based on two variables, namely, temperature at 2 m a.g.l. and incoming solar radiation. The choice of these two climatic parameters is related to the fact that they both influence the comfort inside the buildings. Therefore, we generate files with the typical year according to the temperature at 2 m a.g.l. and a typical year according to the incoming solar radiation.

Here are the steps to find the most typical (extreme) month for each climatic parameter:

1. Converting an hourly file into a daily file: from all the hourly data from all the same calendar months available within the selected period, the daily mean of the climatic parameter is computed.
2. Selecting the typical (extreme) month: for each calendar month, the percentile 50 (95) of the climatic parameter is calculated over the studied period to find the month that is the closest to the 50 percentile (95) of this climatic parameter.
3. Extracting hourly data of this typical (extreme) month: finally, the hourly weather values of this typical (extreme) month are stored in the file of the typical (extreme) year.

The hourly weather variables available in the TMY and XMY files are described in Table 2.

Table 1. Comparison of MAR-ERA5 (i.e. MAR forced by the reanalysis ERA5) with MAR-BCC (i.e. MAR forced by BCC-CSM2-MR), MAR-MPI (i.e. MAR forced by MPI-ESM.1.2), and MAR-MIR (i.e. MAR forced by MIROC6) to mean temperature at 2 m above ground level and mean incoming solar radiation over Belgium’s territory during 1980–2014 (mean value \pm standard error).

1980–2014 over Belgian territory	Timescale	MAR-ERA5	MAR-BCC	MAR-MPI	MAR-MIR
Mean temperature at 2 m a.g.l. (in °C)	annual	10.1 \pm 6.2	10.3 \pm 6.0	10.1 \pm 6.4	10.4 \pm 7.2
	summer	17.7 \pm 1.3	17.6 \pm 1.7	18.6 \pm 1.2	19.9 \pm 1.1
Mean incoming solar radiation (in W m^{-2})	annual	119 \pm 78	122 \pm 79	116 \pm 83	134 \pm 85
	summer	213 \pm 20	221 \pm 20	224 \pm 22	239 \pm 25

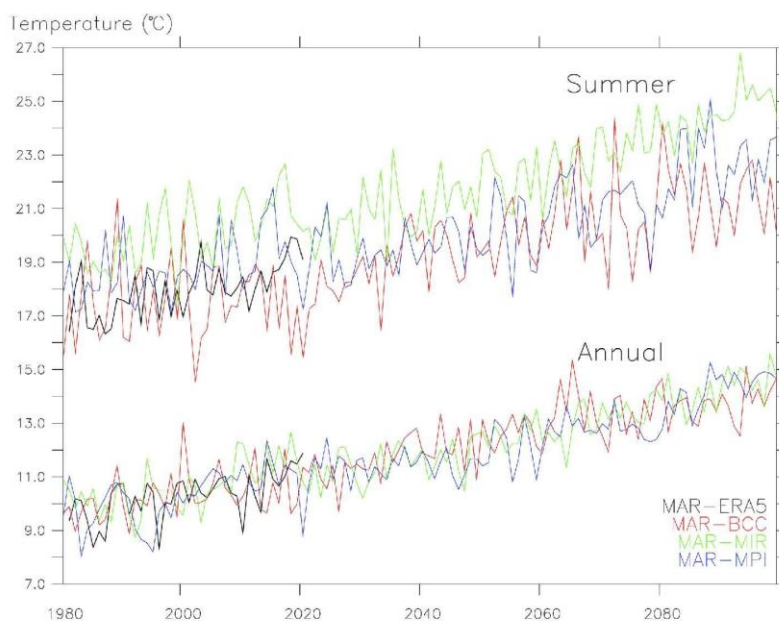

Figure 3. Annual mean temperature (in °C, lower lines) and annual summer temperature (in °C, upper lines) of MAR forced by ERA5 reanalysis (in black lines between 1980 and 2020), MAR-BCC (i.e. MAR forced by BCC-CSM2-MR in red lines), MAR-MPI (i.e. MAR forced by MPI-ESM.1.2 in blue lines), and MAR-MIR (i.e. MAR forced by MIROC6 in green lines) between 1980 and 2100 according to the scenario SSP5-8.5. The average is computed here over the whole integration domain, excluding the ocean.

2.4 Definition of a heatwave and generating heatwave event files

In Belgium, heatwaves are officially defined by two definitions: a retrospective one and a prospective one. The retrospective heatwave is defined as periods of at least five consecutive days with a maximum temperature higher than 25 °C, of which, at least 3 days within this period has a maximum temperature higher than 30 °C (RMI, 2020). The prospective heatwave is a period with a predicted minimum temperature of 18.2 °C or more and a maximum temperature of 29.6 °C or higher, both for three consecutive days (Brits et al., 2009).

However, these definitions are static and do not consider the local climate of each region. For example, in the highlands (with altitudes above 300 m in Fig. 2) where it is on av-

erage colder, these heatwave criteria are not necessarily met, even though this region also experiences a heatwave. Moreover, when comparing the different ESMs, this fixed heatwave definition criterion could induce artefacts, since each ESM has its own variability and biases over the current climate. For these reasons, we have used the statistical definition of a heatwave from Ouzeau et al. (2016), computed for each MAR pixel regardless of its basic climate and each ESM independently of its own internal variability.

The calculation method, according to Ouzeau et al. (2016), is as follows and it is illustrated in Fig. 4:

- For the period 1980–2014 (which corresponds to the “historical” scenario in the ESMs), for each pixel and each MAR simulation, we calculate three thresholds de-

Table 2. Name, level, and units of all weather variables used in the produced weather files.

Weather variable name	Level	Units
Dry bulb temperature	2 m a.g.l.	°C
Relative humidity	2 m a.g.l.	%
Global horizontal radiation	Ground (horizontal surface)	W m^{-2}
Diffuse solar radiation	Ground (horizontal surface)	W m^{-2}
Direct normal radiation	Ground (horizontal surface)	W m^{-2}
Wind speed	10 m a.g.l.	m s^{-1}
Wind direction	10 m a.g.l.	north degrees
Dew point temperature	2 m a.g.l.	°C
Atmospheric pressure	ground	Pa
Cloudiness	All troposphere	tenths
Sky temperature	All troposphere	K (according to Duffie and Beckman, 2013)
Specific humidity	2 m a.g.l.	kg kg^{-1}
Precipitation	Ground	mm

fined by three percentiles of the daily mean temperature: $S_{int} = 95$ th percentile, $S_{deb} = 97.5$ th percentile, and $S_{pic} = 99.5$ th percentile.

- A heatwave is detected when the daily mean temperature reaches S_{pic} . The duration of this event is the number of days between the first day when the daily mean temperature is equal to or greater than S_{deb} , and either when the daily mean temperature falls below S_{int} or when the daily mean temperature falls below S_{deb} for at least three consecutive days.
- In this data set, we add a condition compared to Ouzeau et al. (2016), which is that the minimum duration of the heatwave must be at least five consecutive days, otherwise the heatwave event is not considered as such.

Once the heatwave events (called HWE hereafter) are detected, we can characterise them according to three criteria:

1. the duration, which is the number of consecutive days of the HWE;
2. the maximal daily mean temperature reached during the HWE;
3. the global intensity, which is calculated by the cumulative difference between the temperature and the S_{deb} threshold during the HWE, divided by the difference between S_{pic} and S_{deb} .

The hourly data provided in each HWE file are the same as for the TMY and XMY files (see section above). For each period, each city, each scenario, and each forcing, four files are created:

- a file containing hourly weather data for the longest HWE;
- a file containing the hourly weather data of the HWE characterised by the highest daily average temperature;

- a file containing the hourly weather data of the HWE characterised by the highest intensity;

- a file that concatenates all the hourly weather data of all the HWEs present in a period, for each city, each scenario, and each MAR model.

Finally, the HWE files contain only the period corresponding to a heatwave event. However, depending on the purpose of the users, the effects of a heatwave can also be dependent on the period preceding and/or following it. Thus, a suggestion for users could be to combine HWE files with files of typical or extreme years in order to obtain simulations of a normal year with one or more heatwaves. We have not built these files so that users can decide whether to combine these files or not, and to prepare them according to their own constraints and interests.

3 The data set

3.1 Data availability

The data described in this article can be freely accessed on the Zenodo open-access repository: <https://doi.org/10.5281/zenodo.5606983> (Doutreloup and Fettweis, 2021). As the files are numerous, each zipped folder contains all the data for each city concerned with this data set.

3.2 Structure of each file

All files are in a CSV format and are comma-separated. The file names are formatted in such a way that they contain all the information about the origin of the file. Each file name is composed as follows:

- for TMY or XMY:
CityName_Type_Period_Scenario_MARmodel
_ClimaticParameter.csv;

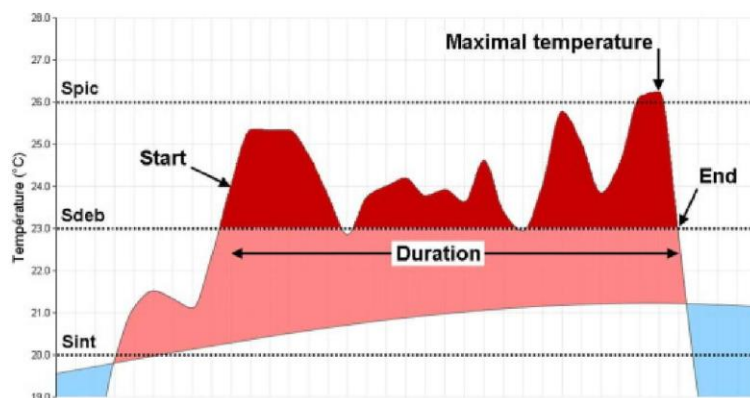

Figure 4. Figure and legend from Ouzeau et al. (2016): characterisation of a heatwave from a daily mean temperature indicator over France (example of a time series from 30 June to 5 August 1983). Duration (start and end), maximal temperature, and global intensity (red area of the plot). Temperatures above (below) the climatological line (1981–2010 reference period) are represented by the pink (blue) area. (For an interpretation of the references to colour in this figure legend, the reader is referred to Ouzeau et al., 2016).

- for heatwaves: CityName_Type_Period_Scenario_MARmodel.csv;

with

- city name: the name of the city considered in this file;
- type: the nature of this file, namely, TMY (typical meteorological year), XMY (extreme meteorological year), HWE-HI (most intense heatwave event), HWE-HT (warmest heatwave event), HWE-LD (longest heatwave event), and HWE-all (all heatwave events);
- period: the time period considered;
- scenario: the IPCC scenario of the ESM considered, namely, “hist”, “SSP5-8.5”, “SSP3-7.0”, and “SSP2-4.5” (note that for MAR-ERA5, the name of the scenario is set by default to “hist” even if the ERA5 forcing does not contain any scenario);
- MAR model: the version of MAR used, namely, MAR-ERA5, MAR-BCC, MAR-MPI or MAR-MIR.

For TMY and XMY files, the header is composed of the task number (which is a reference number for internal use in the OCCuPANT project), the name of the city, and the name of the different variables accompanied by their unit. For HWE files, the header is composed of the task number (same remark as above), the name of the city, the characterisation of the heatwave (longest, warmest, and most intense) accompanied by its period, and the name of the different variables accompanied by their unit. Then comes the weather data with the time variable in the first column. Weather data are in universal time and leap year mode for the MAR-ERA5 and in no-leap year mode for MAR-BCC, MAR-MPI, and MAR-MIR.

A short example of how to select the desired data and files, as well as an example of how to use them, is provided in Appendix A for Liège-City.

4 Conclusion

The goal of this data set is to provide formatted and adapted meteorological data for specific users who work in building designing, architecture, building energy management systems, modelling renewable energy conversion systems, or other people interested in this kind of data. These weather data are derived from the regional climate MAR model. This regional model, adapted and validated over Belgium, is forced by a reanalysis and three ESMs. On the one hand, MAR is forced by the ERA5 reanalysis to represent the closest climate to reality. On the other hand, MAR is forced by three ESMs from the CMIP6 database, namely, BCC-CSM2-MR, MPI-ESM.1.2, and MIROC6. The main advantage of using the MAR model is that the generated weather data at a high resolution are spatially and temporally homogeneous.

The generated weather data follow two protocols. Firstly, the TMY and XMY meteorological data are generated largely inspired by the method proposed by the standard ISO15927-4, allowing the reconstruction of typical and extreme years, while keeping the plausible variability of the meteorological data. Secondly, the meteorological data concerning heatwaves (HWE) are generated according to the method proposed by Ouzeau et al. (2016) to detect the heatwave events and classify them according to three criteria of the heatwave. The OCCuPANT project, in which this paper is included, aims to identify the highest temperature, the longest heatwave duration, and the most intense heatwave event. Finally, all generated weather data are open source and freely available on the open

repository Zenodo (<https://doi.org/10.5281/zenodo.5606983>, Doutreloup and Fettweis, 2021).

Appendix A: Example for Liège city

The Liège folder contains 596 files. This is a huge amount of files, so to find your way around, we suggest the following method for TMY and XMY files:

1. choose a typical or extreme year, i.e. select XMY for an extreme year;
2. choose the parameter that determines the typical or extreme year (TT for temperature and SWD for incoming solar radiation), i.e. if you want a year with extreme incoming solar radiation (i.e. sunshine), you should select SWDbased;
3. choose the reference period, i.e. 2085–2100 for the end of the century;
4. choose the socio-economic scenario, i.e. “ssp585” for a world that continues to use fossil fuels according to the SSP5-8.5 scenario;
5. choose one of the 3 MAR models, i.e. MAR-BCC for the MAR model forced by BCC-CSM2-MR;
6. finally, the choice is made for the file:
Liège-City_XMY2085-2100_ssp585_MAR-BCC_SWDbased.csv.

This file selection method is a proposal, but each user is free to develop their own method and, of course, the user can use several files to compare them. For example, if the user wants to compare typical and extreme temperatures for the end of the century and for the two selected parameters with MAR-BCC, the user gets Fig. A1. Figure A1 clearly shows that the extreme year temperature based on temperature is much higher than the typical year temperature. On the other hand, the extreme year temperature based on incoming solar radiation is much lower – especially in January – than the typical year temperature, because extreme radiation in winter usually means cold weather.

The method is almost identical for the heatwave files, except that there are no parameters to determine the typical and extreme years; instead, the user has to choose if they want to look at the longest, the most intense, the hottest, or all heatwaves present within the period. Therefore, if the user wants to compare the longest heatwave (HWE-LD) over the same period and for the same model and scenario as the example above, the user must choose the file: Liège-City_HWE-LD_2085-2100_ssp585_MAR-BCC.csv

Figure A2 compares the temperature evolution during the warmest heatwave, obtained from each of the MAR-BCC, MAR-MPI, and MAR-MIR simulations. The header of each file shows the warmest daily average temperature, namely, 37.2 °C for MAR-BCC, 35.3 °C for MAR-MPI, and 37.8 °C for MAR-MIR. However, it can be seen in Fig. A2 that the hourly temperatures obviously rise much higher than these daily average values and, in this case, rise to ~44 °C for MAR-BCC and MAR-MIR, and ~42 °C for MAR-MPI.

Table A1. Full name, abbreviation name, lead institution, and references of the Earth system model (ESM) used in this study.

Full name of the ESM	Abbreviation name of the ESM	Lead institution	References
BCC-CSM2-MR	BCC	Beijing Climate Centre	Wu et al. (2019)
MPI-ESM1-2-HR	MPI	Max Planck Institute	Gutjahr et al. (2019)
MIROC6	MIR	Japanese modelling community	Tatebe et al. (2019)

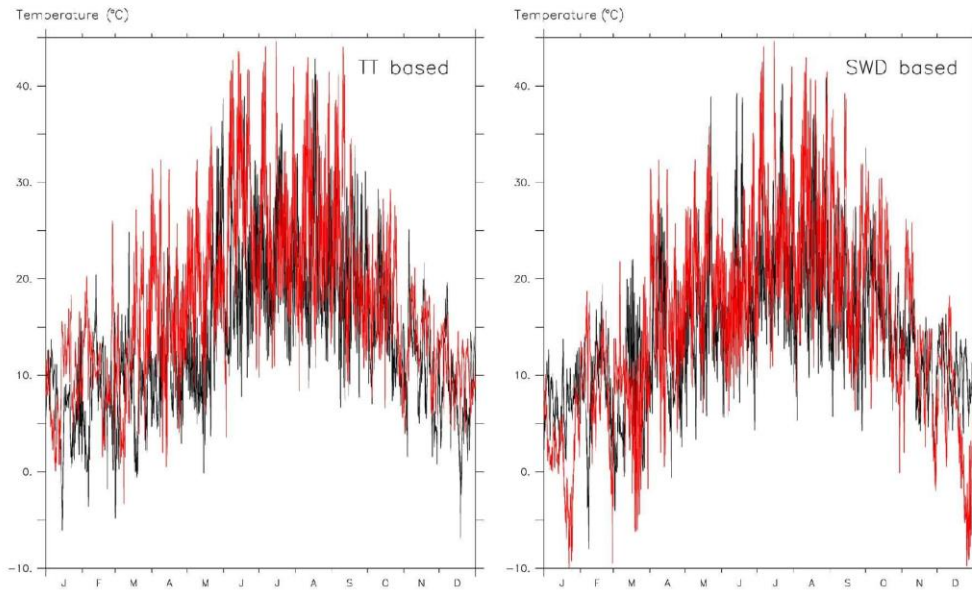

Figure A1. Typical (black) and extreme (red) temperature for Liège city, simulated by MAR forced by BCC-CSM2-MR, with the scenario SSP5-8.5 for the period 2085–2100. The typical/extreme months are based on temperature (left) and incoming solar radiation (right). These data are extracted from these files: Liège-City_TMY2085-2100_ssp585_MAR-BCC_TTbased.csv, Liège-City_XMY2085-2100_ssp585_MAR-BCC_TTbased.csv, Liège-City_TMY2085-2100_ssp585_MAR-BCC_SWDbased.csv, and Liège-City_XMY2085-2100_ssp585_MAR-BCC_SWDbased.csv.

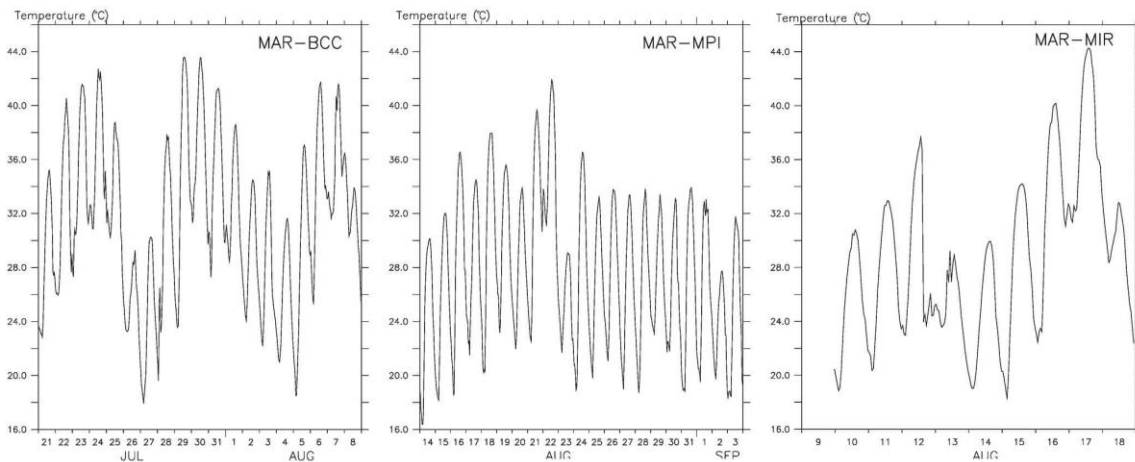

Figure A2. Temperature during warmest heatwave events for Liège city simulated by MAR-BCC (i.e. MAR forced by BCC-CSM2-MR), MAR-MPI (i.e. MAR forced by MPI-ESM1.2), and MAR-MIR (i.e. MAR forced by MIROC6), with the scenario SSP5-8.5 for the period 2085–2100. These data are, respectively, extracted from these files: Liège-City_HWE-HT_2085-2100_ssp585_MAR-BCC.csv, Liège-City_HWE-HT_2085-2100_ssp585_MAR-MPI.csv, and Liège-City_HWE-HT_2085-2100_ssp585_MAR-MIR.csv.

Author contributions. SD, XF, RR, EE, MSP, DA and SA participated in the conceptualisation of this paper. SD and XF designed the experiments and methodology, and SD carried them out. SD prepared and created figures and data. XF oversaw the research. SD wrote the initial manuscript and SD, XF, RR, EE, MSP, DA and SA participated in the revisions. SA leads the project administration.

Competing interests. The contact author has declared that neither they nor their co-authors have any competing interests.

Disclaimer. Publisher's note: Copernicus Publications remains neutral with regard to jurisdictional claims in published maps and institutional affiliations.

Acknowledgements. The authors would like to gratefully acknowledge the Walloon Region and Liège University for the funding. Computational resources have been provided by the Consortium des Équipements de Calcul Intensif (CÉCI), funded by the Fonds de la Recherche Scientifique de Belgique (F.R.S.-FNRS), under grant no. 2.5020.11 and by the Walloon Region.

Financial support. This research was partially funded by the Walloon Region, under the call "Actions de Recherche Concertées 2019 (ARC)" and the project OCCuPANT, on the Impacts Of Climate Change on the indoor environmental and energy Performance of buildings in Belgium during summer.

Review statement. This paper was edited by David Carlson and reviewed by two anonymous referees.

References

- Agosta, C., Amory, C., Kittel, C., Orsi, A., Favier, V., Gallée, H., van den Broeke, M. R., Lenaerts, J. T. M., van Wessem, J. M., van de Berg, W. J., and Fettweis, X.: Estimation of the Antarctic surface mass balance using the regional climate model MAR (1979–2015) and identification of dominant processes, *The Cryosphere*, 13, 281–296, <https://doi.org/10.5194/tc-13-281-2019>, 2019.
- Barnaby, C. S. and Crawley, U. B.: Weather data for building performance simulation, in: *Building Performance Simulation for Design and Operation*, edited by: Hensen J. L. M. and Lamberts R., Routledge, London, <https://doi.org/10.4324/9780203891612>, 2011.
- Bruffaerts, N., De Smedt, T., Delcloo, A., Simons, K., Hoebeke, L., Verstraeten, C., Van Nieuwenhuysse, A., Packeu, A., and Hendrickx, M.: Comparative long-term trend analysis of daily weather conditions with daily pollen concentrations in Brussels, Belgium, *Int. J. Biometeorol.*, 62, 483–491, <https://doi.org/10.1007/s00484-017-1457-3>, 2018.
- Buysse, D. J., Cheng, Y., Germain, A., Moul, D. E., Franzen, P. L., Fletcher, M., and Monk, T. H.: Night-to-night sleep variability in older adults with and without chronic insomnia, *Sleep Med.*, 11, 56–64, <https://doi.org/10.1016/j.sleep.2009.02.010>, 2010.
- Connolley, W. M. and Bracegirdle, T. J.: An Antarctic assessment of IPCC AR4 coupled models, *Geophys. Res. Lett.*, 34, L22505, <https://doi.org/10.1029/2007GL031648>, 2007.
- Doutreloup, S. and Fettweis X.: Typical & Extreme Meteorological Year and Heatwaves for Dynamic Building Simulations in Belgium based on MAR model Simulations (version 1.0.0), Zenodo [data set], <https://doi.org/10.5281/zenodo.5606983>, 2021.
- Doutreloup, S., Wyard, C., Amory, C., Kittel, C., Ericum, M., and Fettweis, X.: Sensitivity to Convective Schemes on Precipitation Simulated by the Regional Climate Model MAR over Belgium (1987–2017), *Atmosphere*, 10, 34, <https://doi.org/10.3390/atmos10010034>, 2019.
- Duffie, J. A. and Beckman, W. A.: *Solar Engineering of Thermal Processes*, 4th edn., John Wiley & Sons, Inc., Hoboken, New Jersey, ISBN 978-0-470-87366-3, 2013.
- Dunn, R. J. H., Alexander, L. V., Donat, M. G., Zhang, X., Bador, M., Herold, N., Lippmann, T., Allan, R., Aguilar, E., Barry, A. A., Brunet, M., Caesar, J., Chagnaud, G., Cheng, V., Cinco, T., Durre, I., Guzman, R. de, Htay, T. M., Ibadullah, W. M. W., Ibrahim, M. K. I. B., Khoshkam, M., Kruger, A., Kubota, H., Leng, T. W., Lim, G., Li-Sha, L., Marengo, J., Mbatha, S., McGree, S., Menne, M., Skansi, M. de los M., Ngwenya, S., Nkrumah, F., Oonariya, C., Pabon-Caicedo, J. D., Panthou, G., Pham, C., Rahimzadeh, F., Ramos, A., Salgado, E., Salinger, J., Sané, Y., Sopaheluwakan, A., Srivastava, A., Sun, Y., Timal, B., Trachow, N., Trewin, B., Schrier, G. van der, Vazquez-Aguirre, J., Vasquez, R., Villarroel, C., Vincent, L., Vischel, T., Vose, R., and Yussuf, M. N. B. H.: Development of an Updated Global Land In Situ-Based Data Set of Temperature and Precipitation Extremes: HadEX3, *J. Geophys. Res.-Atmos.*, 125, e2019JD032263, <https://doi.org/10.1029/2019JD032263>, 2020.
- European Standard: EN ISO 15927-4:2005 Hygrothermal performance of buildings – calculation and presentation of climatic data – Part 4: Hourly data for assessing the annual energy use for heating and cooling (ISO 15927-4:2005), 2005.
- Eyring, V., Bony, S., Meehl, G. A., Senior, C. A., Stevens, B., Stouffer, R. J., and Taylor, K. E.: Overview of the Coupled Model Intercomparison Project Phase 6 (CMIP6) experimental design and organization, *Geosci. Model Dev.*, 9, 1937–1958, <https://doi.org/10.5194/gmd-9-1937-2016>, 2016.
- Eyring, V., Gillett, N. P., Achuta Rao, K. M., Barimalala, R., Barreiro Parrillo, M., Bellouin, N., Cassou, C., Durack, P. J., Kosaka, Y., McGregor, S., Min, S., Morgenstern, O., and Sun, Y.: Human Influence on the Climate System, in: *Climate Change 2021: The Physical Science Basis. Contribution of Working Group I to the Sixth Assessment Report of the Intergovernmental Panel on Climate Change*, edited by: Masson-Delmotte, V., Zhai, P., Pirani, A., Connors, S. L., Péan, C., Berger, S., Caud, N., Chen, Y., Goldfarb, L., Gomis, M. I., Huang, M., Leitzell, K., Lonnoy, E., Matthews, J. B. R., Maycock, T. K., Waterfield, T., Yelekçi, O., Yu, R., and Zhou, B., Cambridge University Press, Cambridge, United Kingdom and New York, NY, USA, 423–552, https://www.ipcc.ch/report/ar6/wg1/downloads/report/IPCC_AR6_WGI_Chapter03.pdf (last access: 28 June 2022), 2021.
- Ferrari, D. and Lee, T.: Beyond TMY: Climate data for specific applications, in: *Proceedings 3rd International Solar Energy Society conference – Asia Pacific region (ISES-AP-08)*, Sydney, 25–28 November 2008, <http://exemplary.com>.

- au/download/FerrariLeeBeyondTMYpaperWC0093.pdf (last access: 24 June 2022), 2008.
- Fettweis, X., Franco, B., Tedesco, M., van Angelen, J. H., Lenaerts, J. T. M., van den Broeke, M. R., and Gallée, H.: Estimating the Greenland ice sheet surface mass balance contribution to future sea level rise using the regional atmospheric climate model MAR, *The Cryosphere*, 7, 469–489, <https://doi.org/10.5194/tc-7-469-2013>, 2013.
- Fettweis X., Wyard C., Doutreloup S., and Belleflamme A.: Noël 2010 en Belgique: neige en Flandre et pluie en Haute-Ardenne, *Bull. Société Géographique Liège*, 68, 97–107, 2017.
- Finkelstein, J. M. and Schafer, R. E.: Improved goodness-of-fit tests, *Biometrika*, 58, 641–645, <https://doi.org/10.1093/biomet/58.3.641>, 1971.
- Fouillet, A., Rey, G., Laurent, F., Pavillon, G., Bellec, S., Guihenneuc-Jouyau, C., Clavel, J., Jouglé, E., and Hémon, D.: Excess mortality related to the August 2003 heat wave in France, *Int. Arch. Occup. Environ. Health*, 80, 16–24, <https://doi.org/10.1007/s00420-006-0089-4>, 2006.
- Gutjahr, O., Putrasahan, D., Lohmann, K., Jungclauss, J. H., von Storch, J.-S., Brüggemann, N., Haak, H., and Stössel, A.: Max Planck Institute Earth System Model (MPI-ESM1.2) for the High-Resolution Model Intercomparison Project (HighResMIP), *Geosci. Model Dev.*, 12, 3241–3281, <https://doi.org/10.5194/gmd-12-3241-2019>, 2019.
- Hersbach, H., Bell, B., Berrisford, P., Hirahara, S., Horányi, A., Muñoz-Sabater, J., Nicolas, J., Peubey, C., Radu, R., Schepers, D., Simmons, A., Soci, C., Abdalla, S., Abellan, X., Balsamo, G., Bechtold, P., Biavati, G., Bidlot, J., Bonavita, M., Chiara, G. D., Dahlgren, P., Dee, D., Diamantakis, M., Dragani, R., Fleming, J., Forbes, R., Fuentes, M., Geer, A., Haimberger, L., Healy, S., Hogan, R. J., Hólm, E., Janisková, M., Keeley, S., Laloyaux, P., Lopez, P., Lupu, C., Radnoti, G., Rosnay, P. de Rozum, I., Vamborg, F., Villaume, S., and Thépaut, J.-N.: The ERA5 global reanalysis, *Q. J. Roy. Meteor. Soc.*, 146, 1999–2049, <https://doi.org/10.1002/qj.3803>, 2020.
- IPCC: Summary for Policymakers, in: *Climate Change 2021: The Physical Science Basis. Contribution of Working Group I to the Sixth Assessment Report of the Intergovernmental Panel on Climate Change*, edited by: Masson-Delmotte, V., Zhai, P., Pirani, A., Connors, S. L., Péan, C., Berger, S., Caud, N., Chen, Y., Goldfarb, L., Gomis, M. I., Huang, M., Leitzell, K., Lonnoy, E., Matthews, J. B. R., Maycock, T. K., Waterfield, T., Yelekçi, O., Yu, R., and Zhou, B., Cambridge University Press, Cambridge, United Kingdom and New York, NY, USA, 3–32, https://www.ipcc.ch/report/ar6/wg1/downloads/report/IPCC_AR6_WGI_SPM.pdf (last access: 28 June 2022), 2021.
- Kittel, C.: Present and future sensitivity of the Antarctic surface mass balance to oceanic and atmospheric forcings: insights with the regional climate model MAR, PhD Thesis, Université de Liège, Liège, Belgique, Liège, <https://hdl.handle.net/2268/258491> (last access: 24 June 2022), 2021.
- Kittel, C., Amory, C., Agosta, C., Jourdain, N. C., Hofer, S., Delhasse, A., Doutreloup, S., Huot, P.-V., Lang, C., Fichet, T., and Fettweis, X.: Diverging future surface mass balance between the Antarctic ice shelves and grounded ice sheet, *The Cryosphere*, 15, 1215–1236, <https://doi.org/10.5194/tc-15-1215-2021>, 2021.
- Larsen, M. A. D., Petrović, S., Radoszynski, A. M., McKenna, R., and Balyk, O.: Climate change impacts on trends and extremes in future heating and cooling demands over Europe, *Energy Build.*, 226, 110397, <https://doi.org/10.1016/j.enbuild.2020.110397>, 2020.
- Lee, J. Y., Marotzke, J., Bala, G., Cao, L., Corti, S., Dunne, J. P., Engelbrecht, F., Fischer, E., Fyfe, J. C., Jones, C., Maycock, A., Mutemi, J., Ndiaye, O., Panickal, S., and Zhou, T.: *Future Global Climate: Scenario-Based Projections and Near-Term Information*, Camb. Univ. Press, Climate Change 2021: The Physical Science Basis. Contribution of Working Group I to the Sixth Assessment Report of the Intergovernmental Panel on Climate Change, edited by: Masson-Delmotte, V., Zhai, P., Pirani, A., Connors, S. L., Péan, C., Berger, S., Caud, N., Chen, Y., Goldfarb, L., Gomis, M. I., Huang, M., Leitzell, K., Lonnoy, E., Matthews, J. B. R., Maycock, T. K., Waterfield, T., Yelekçi, O., Yu, R., and Zhou, B., Cambridge University Press, Cambridge, United Kingdom and New York, NY, USA, 553–672, https://www.ipcc.ch/report/ar6/wg1/downloads/report/IPCC_AR6_WGI_Chapter04.pdf (last access: 28 June 2022), 2021.
- Ouzeau, G., Soubeyroux, J.-M., Schneider, M., Vautard, R., and Planton, S.: Heat waves analysis over France in present and future climate: Application of a new method on the EURO-CORDEX ensemble, *Clim. Serv.*, 4, 1–12, <https://doi.org/10.1016/j.cliser.2016.09.002>, 2016.
- Pérez-Andreu V., Aparicio-Fernández C., Martínez-Iberón A., and Vivancos J.-L.: Impact of climate change on heating and cooling energy demand in a residential building in a Mediterranean climate, *Energy*, 165, 63–74, <https://doi.org/10.1016/j.energy.2018.09.015>, 2018.
- Ramon, D., Allacker, K., van Lipzig, N. P. M., De Troyer, F., and Wouters, H.: Future Weather Data for Dynamic Building Energy Simulations: Overview of Available Data and Presentation of Newly Derived Data for Belgium, in: *Energy Sustainability in Built and Urban Environments*, 1st edn., edited by: Motoasca, E., Agarwal, A. K., and Breesch, H., Springer, Singapore, 111–138, ISBN 978-981-13-3283-8, https://doi.org/10.1007/978-981-13-3284-5_6, 2019.
- Riahi, K., van Vuuren, D. P., Kriegler, E., Edmonds, J., O'Neill, B. C., Fujimori, S., Bauer, N., Calvin, K., Dellink, R., Fricko, O., Lutz, W., Popp, A., Cuervo, J. C., Kc, S., Leimbach, M., Jiang, L., Kram, T., Rao, S., Emmerling, J., Ebi, K., Hasegawa, T., Havlik, P., Humpenöder, F., Da Silva, L. A., Smith, S., Stehfest, E., Bosetti, V., Eom, J., Gernaat, D., Masui, T., Rogelj, J., Strefler, J., Drouet, L., Krey, V., Luderer, G., Harmsen, M., Takahashi, K., Baumstark, L., Doelman, J. C., Kainuma, M., Klimont, Z., Marangoni, G., Lotze-Campen, H., Obersteiner, M., Tabeau, A., and Tavoni, M.: The Shared Socioeconomic Pathways and their energy, land use, and greenhouse gas emissions implications: An overview, *Global Environ. Chang.*, 42, 153–168, <https://doi.org/10.1016/j.gloenvcha.2016.05.009>, 2017.
- Ridder, K. D. and Gallée, H.: Land Surface-Induced Regional Climate Change in Southern Israel, *J. Appl. Meteorol. Climatol.*, 37, 1470–1485, [https://doi.org/10.1175/1520-0450\(1998\)037<1470:LSIRCC>2.0.CO;2](https://doi.org/10.1175/1520-0450(1998)037<1470:LSIRCC>2.0.CO;2), 1998.
- RMI: Rapport climatique 2020 de l'information aux services climatiques, edited by: Gellens, D., Royal Meteorological Institute of Belgium, Brussels, ISSN 2033-8562, <https://www.meteo>.

- be/resources/misc/climate_report/RapportClimatique-2020.pdf (last access: 24 June 2022), 2020.
- Seneviratne, S. I., Zhang, X., Adnan, M., Badi, W., Dereczynski, C., Di Luca, A., Ghosh, S., Iskandar, I., Kossin, J., Lewis, S., Otto, F., Pinto, I., Satoh, M., Vicente-Serrano, S. M., Wehner, M., and Zhou, B.: Weather and Climate Extreme Events in a Changing Climate, in: *Climate Change 2021: The Physical Science Basis. Contribution of Working Group I to the Sixth Assessment Report of the Intergovernmental Panel on Climate Change*, edited by: Masson-Delmotte, V., Zhai, P., Pirani, A., Connors, S. L., Péan, C., Berger, S., Caud, N., Chen, Y., Goldfarb, L., Gomis, M. I., Huang, M., Leitzell, K., Lonnoy, E., Matthews, J. B. R., Maycock, T. K., Waterfield, T., Yelekçi, O., Yu, R., and Zhou, B., Cambridge University Press, Cambridge, United Kingdom and New York, NY, USA, pp. 1513–1766, https://www.ipcc.ch/report/ar6/wg1/downloads/report/IPCC_AR6_WGI_Chapter11.pdf (last access: 28 June 2022), 2021.
- Sherwood, S. C. and Huber, M.: An adaptability limit to climate change due to heat stress, *P. Natl. Acad. Sci. USA*, 107, 9552–9555, <https://doi.org/10.1073/pnas.0913352107>, 2010.
- Suarez-Gutierrez, L., Müller, W. A., Li, C., and Marotzke, J.: Hotspots of extreme heat under global warming, *Clim. Dynam.*, 55, 429–447, <https://doi.org/10.1007/s00382-020-05263-w>, 2020.
- Tatebe, H., Ogura, T., Nitta, T., Komuro, Y., Ogochi, K., Takemura, T., Sudo, K., Sekiguchi, M., Abe, M., Saito, F., Chikira, M., Watanabe, S., Mori, M., Hirota, N., Kawatani, Y., Mochizuki, T., Yoshimura, K., Takata, K., O'ishi, R., Yamazaki, D., Suzuki, T., Kurogi, M., Kataoka, T., Watanabe, M., and Kimoto, M.: Description and basic evaluation of simulated mean state, internal variability, and climate sensitivity in MIROC6, *Geosci. Model Dev.*, 12, 2727–2765, <https://doi.org/10.5194/gmd-12-2727-2019>, 2019.
- Termonia, P., Van Schaeuybroeck, B., De Cruz, L., De Troch, R., Caluwaerts, S., Giot, O., Hamdi, R., Vannitsem, S., Duchêne, F., Willems, P., Tabari, H., Van Uytven, E., Hosseinzadehtalaei, P., Van Lipzig, N., Wouters, H., Vanden Broucke, S., van Ypersele, J.-P., Marbaix, P., Villanueva-Birriel, C., Fettweis, X., Wyard, C., Scholzen, C., Doutreloup, S., De Ridder, K., Gobin, A., Lauwaet, D., Stavrakou, T., Bauwens, M., Müller, J.-F., Luyten, P., Ponsar, S., Van den Eynde, D., and Pottiaux, E.: The CORDEX.be initiative as a foundation for climate services in Belgium, *Clim. Serv.*, 11, 49–61, <https://doi.org/10.1016/j.cliser.2018.05.001>, 2018.
- Brits E., Boone I., Verhagen B., Dispas M., Vanoyen H., Van der Stede Y., and Van Nieuwenhuysse A.: Climate change and health: set-up of monitoring of potential effects of climate change on human health and on the health of animals in Belgium. Unit environment and health, Brussels, Belgium, https://www.belspo.be/belspo/organisation/publ/pub_ostc/agora/ragij146_en.pdf (last access: 28 June 2022), 2009.
- Wilcox, S. and Marion, W.: Users Manual for TMY3 Data Sets, Technical report NREL/TP-581-43156, Task No. PVA7.6101, <https://www.nrel.gov/docs/fy08osti/43156.pdf>, 2008.
- Wu, T., Lu, Y., Fang, Y., Xin, X., Li, L., Li, W., Jie, W., Zhang, J., Liu, Y., Zhang, L., Zhang, F., Zhang, Y., Wu, F., Li, J., Chu, M., Wang, Z., Shi, X., Liu, X., Wei, M., Huang, A., Zhang, Y., and Liu, X.: The Beijing Climate Center Climate System Model (BCC-CSM): the main progress from CMIP5 to CMIP6, *Geosci. Model Dev.*, 12, 1573–1600, <https://doi.org/10.5194/gmd-12-1573-2019>, 2019.
- Wyard, C., Scholzen, C., Doutreloup, S., Hallot, É., and Fettweis, X.: Future evolution of the hydroclimatic conditions favouring floods in the south-east of Belgium by 2100 using a regional climate model, *Int. J. Climatol.*, 41, 647–662, <https://doi.org/10.1002/joc.6642>, 2021.

Appendix D

Chapter 04: *Framework to assess climate change impact on heating and cooling energy demands in building stock: A case study of Belgium in 2050 and 2100.*

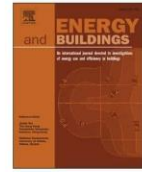

Framework to assess climate change impact on heating and cooling energy demands in building stock: A case study of Belgium in 2050 and 2100

Essam Elnagar^{a,*}, Samuel Gendebien^a, Emeline Georges^b, Umberto Berardi^c, Sébastien Doutreloup^d, Vincent Lemort^a

^a Thermodynamics Laboratory, Aerospace and Mechanical Engineering Department, Faculty of Applied Sciences, University of Liège, Belgium

^b Alumna of Thermodynamics Laboratory, Aerospace and Mechanical Engineering Department, Faculty of Applied Sciences, University of Liège, Belgium

^c Department of Architectural Science, Toronto Metropolitan University, Toronto, Canada

^d Laboratory of Climatology and Topoclimatology, Department of Geography, UR SPHERES, University of Liège, Belgium

ARTICLE INFO

Keywords:

Climate change
Heating energy demand
Cooling energy demand
Building stock
Renovation strategies

ABSTRACT

Climate change has a broad impact on different aspects of energy use in buildings. This study explores potential changes in future heating and cooling energy demands. Increasing comfort expectations resulting from events like the extraordinary summer heatwaves in Europe are accelerating this trend to develop future scenarios for a better understanding of the relationship between future climate changes and the cooling need. This study used future weather data to estimate the heating and cooling energy demands in the Belgian building stock by 2050 and 2100 under base and business-as-usual scenarios using a dynamic building simulation model. The study showed that heating energy demand in the base scenario is expected to decrease by 8% to 13% in the 2050s and 13% to 22% in the 2090s compared to the 2010s. Additionally, the cooling energy demand is expected to increase by 39% to 65% in the 2050s and by 61% to 123% in the 2090s compared to the 2010s. Retrofit strategies applied to different building types contribute to lower the increase in cooling energy demand in the business-as-usual scenario compared to the base scenario. The cooling energy demand for an average building in the business-as-usual scenario is expected to increase with a range of 25% to 71% in the 2050s compared to 45% to 92% in the base scenario and 77% to 154% in the 2090s compared to 72% to 198% in the base scenario compared to the 2010s. The findings of the study provide insights to mitigate the impacts of climate change on heating and cooling energy demands.

1. Introduction

In recent years, there has been a growing emphasis on the issue of global warming and climate change. The sixth assessment report by the Intergovernmental Panel on Climate Change (IPCC) highlights that the 21st century will witness a surpassing of the 1.5 °C and 2 °C global warming thresholds. According to the report, the average global surface air temperature is projected to rise by 1 to 5.7 °C between 2081 and 2100 compared to the period between 1850 and 1900, depending on the various CO₂ emission scenarios [1,2]. The energy demand for HVAC systems increases significantly as a result of this temperature rise. Warmer temperatures increase the demand for air conditioning [3], while more frequent heat waves increase the demand for cooling. On the other hand, declining temperature levels, particularly in winter, reduce the demand for heating. Over the coming years, changes in CO₂

emissions are anticipated to have an impact on humidity, wind patterns, and solar radiation [4–6].

Various emissions scenarios have been defined to evaluate potential future climate changes and assess their possible impacts [7,8]. The calculation of these emissions scenarios involves the utilization of diverse models that encompass societal development, taking into account economic factors and technological advancements. Five narrative scenarios, along with a set of radiative forcing levels, have been established. Each scenario encompasses distinct groups that represent alternative energy technology advancements, thereby influencing carbon emissions [8]. Each of these scenarios is fed into Earth System Models (ESMs) to provide climate projections [9]. The set of these ESMs is listed in the CMIP6 (Sixth Coupled Model Intercomparison Project) database [2].

The disadvantage of the models proposed by the CMIP6 is that global models have a coarse spatiotemporal resolution (~100 km and ~6 h).

* Corresponding author.

E-mail address: essam.elnagar@uliege.be (E. Elnagar).

<https://doi.org/10.1016/j.enbuild.2023.113547>

Received 18 May 2023; Received in revised form 16 August 2023; Accepted 12 September 2023

Available online 14 September 2023

0378-7788/© 2023 Elsevier B.V. All rights reserved.

Abbreviations		Nomenclature	
ASHRAE	American Society of Heating, Refrigerating and Air-Conditioning Engineers	1/H	Thermal resistance [1/(W/K)]
ACH	Air Change Per Hour	A	Effective surface area of occupants [m ²]
BAU	Business-as-usual	C _m	Thermal capacity [J/K]
CO ₂	Carbon dioxide	H _{tr,em}	External part of the heat transfer coefficient for non-window opaque elements [W/K]
CMIP6	Sixth Coupled Model Intercomparison Project	H _{tr,is}	Heat transfer coefficient by thermal transmission due to thermal conductance [W/K]
DHW	Domestic Hot Water	H _{tr,ms}	Internal part of the heat transfer coefficient for non-window opaque elements [W/K]
ESM	Earth System Models	H _{tr,op}	Heat transfer coefficient by transmission through opaque components [W/K]
EPB	Energy Performance of Buildings	H _{tr,w}	Heat transfer coefficient by thermal transmission through windows [W/K]
EU	European Union	H _{ve}	Heat transfer due to ventilation [W/K]
ERA5	Fifth-Generation European Reanalysis	Φ	Heat flux [W]
GWh	Gigawatt-hour	Φ _{HC,nd}	Heating or cooling need [W]
GHG	Greenhouse Gas	Φ _{H,max}	Maximum available heating power [W]
HVAC	Heating, Ventilation, and Air Conditioning	Φ _{int}	Heat flow rate due to internal heat source [W]
IPCC	Intergovernmental Panel on Climate Change	Φ _{sol}	Heat flow rate due to solar heat source [W]
ISO	International Organization for Standardization	Φ _{C,max}	Maximum available cooling power [W]
km	Kilometre	θ _{air}	Air temperature node [°C]
kW	Kilowatt	θ _{int,set,H}	Heating setpoint temperature [°C]
kWh	Kilowatt-hour	θ _{int,set,C}	Cooling setpoint temperature [°C]
MWh	Megawatt-hour	θ _s	Surface temperature node [°C]
MAR	Modèle Atmosphérique Régional	θ _m	Mass temperature node [°C]
NG	Natural Gas	θ _{sup}	Supply air temperature [°C]
RCP	Representative Concentration Pathways	θ	Temperature node [°C]
SLPs	Synthetic Load Profiles	m _{occ}	Number of occupants per household [-]
SSP	Shared Socioeconomic Pathways	met _{occ}	Metabolic rate coefficient [-]
SuFiQuaD	Sustainability, Financial and Quality evaluation of Dwelling types		
TABULA	Typology Approach for Building Stock Energy Assessment		
TMY	Typical Meteorological Year		
US	United States		

The use of regional models fed from these global models has the advantage of refining their spatial and temporal resolutions over a specified region.

The impact of climate change on energy demand has become a major concern in recent years, particularly for the building sector. Within the European Union (EU), buildings contribute to 40% of our overall energy consumption and 36% of greenhouse gas emissions. Interestingly, in the majority of European countries, the energy demand for heating purposes significantly surpasses the energy consumed for space cooling [10]. Several studies have been conducted around the world to study the impact of climate change on various building types. However, this impact will vary in the different climate regions, as indicated in Table 1 [11–16]. Wang and Chen [11] focused on their study on assessing how climate change would affect the heating and cooling consumption in residential and commercial buildings across all seven climate zones in the US. The results revealed that by the year 2080, there would be a notable decrease in heating energy demand, ranging from 30% to 65%. On the other hand, cooling energy demand would experience a significant increase of 50% to 150%. Furthermore, the study identified that in certain cities, natural ventilation would no longer be a feasible option by the 2080s, indicating a need for alternative cooling strategies. In a study conducted by Frank [12] in Switzerland, the focus was on studying climate change's influence on heating and cooling energy demands in both residential and office buildings. The study used four different climate scenarios. The results showed residential buildings would experience a decrease in heating energy demand ranging from 33% to 44%. In contrast, office buildings would see a larger decrease in heating energy demand, ranging from 36% to 58%. However, it was observed that the cooling energy demand in both residential and office buildings would increase significantly, with a range of 223% to 1050%. In the Mediterranean climate, Pérez-Andreu et al. [13] assessed the impact of

climate change on heating and cooling energy demands in a residential building. The study analysed eight different models for a house by applying different active and passive measures. The models of the study showed different results in each scenario with the proposed measures to meet or reduce the total cooling energy demand based on the proposed cooling measures.

Berardi and Jafarpur [14] assessed the potential effects of climate change on a set of 16 ASHRAE prototype buildings located in Toronto. The results indicate that by 2070, the heating energy demand for buildings will experience a reduction ranging from 18% to 33%. Conversely, the cooling energy demand is expected to witness an increase ranging from 15% to 126%. Another study conducted by Invidiata and Ghisi [15] assessed the future energy consumption for different buildings in three cities in Brazil for the years 2020, 2050, and 2080. The findings revealed that there will be an increase in the annual energy demand by 112–185% in 2080 across all three cities. However, in the coldest city, the study indicated a significant decrease in the annual heating energy demand by 94%. Additionally, the study explored various passive strategies aimed at mitigating the future annual cooling energy demand, potentially leading to a reduction of up to 50% in both the future cooling energy demands.

While there have been numerous studies examining the impact of climate change on energy demand at the building scale, only a limited number of studies have focused on the building stock scale, particularly with regard to a multi-zone approach at the stock level. Another study by Nik and Kalagasidis [16] assessed the energy performance of the building stock in Sweden by a sample of 153 existing and statistically selected buildings where each building is represented as one thermal zone in the period 1961–2100. The aforementioned study takes into account four factors of uncertainty in climate: global climate models, regional climate models, emissions scenarios, and initial conditions. The

Table 1

Summary of previous literature on climate change impacts on building heating and cooling energy demands. This table is based on a review of published studies, but it is not comprehensive.

Study	Country	Methodology	Simulation tool	Building type	Building approach	Conclusion
Wang & Chen [11]	US	Assuming a 2.7–7 °C temperature increase for the different simulated scenarios with weather projections from 1964 to 2080.	EnergyPlus	Residential and commercial	Typical	Heating energy demand is projected to decrease by 30–65%, and cooling energy demand is projected to increase by 50–150%. The effect of natural ventilation is dramatically reduced, and the average peak energy demand for cooling increases by up to 120%, expecting more significant peaks for punctual heat waves not modelled in the study.
Frank [12]	Switzerland	Assuming a 0.7–4.4 °C temperature increase for the different simulated scenarios for the period 2050–2100.	HELIOS	Residential and commercial	Typical	Heating energy demand is expected to decrease by 33–58%, and the cooling energy demand is expected to increase by up to 1050%.
Pérez-Andreu et al. [13]	Mediterranean climate	Assuming a 1–5.6 °C temperature increase for the different simulated scenarios for temperature projections for 2050 and 2100	TRNSYS	Residential	Typical	Heating energy demand can decrease by up to 90% with the combined effect of climate change, passive measures such as insulation and ventilation with heat recovery. Cooling energy demand increased in future scenarios. To reduce the cooling energy demand in one model, the effectiveness of passive measures such as natural ventilation and the use of shading can deteriorate with climate change but can yet help reduce the cooling energy demand by up to 50%.
Berardi & Jafarpur [14]	Canada	Assuming a 3.7–4.5 °C temperature increase for the different simulated weather scenarios for 2041–2070	OpenStudio	Residential, offices and commercial	Representative	Heating energy demand is expected to decrease by 18%–33%, and cooling energy demand is expected to increase by 15–126%.
Invidiata & Ghisi [15]	Brazil	Assuming a mean temperature increase of 3.6–5.1 °C for the 2020–2080 period.	EnergyPlus	Residential	Typical	Heating energy demand is expected to decrease by 94%. Cooling energy demand is expected to increase, and buildings, therefore, have to be designed to reduce the associated energy consumption. Using passive strategies helps to reduce the increase by up to 50%.
Nik & Kalagasidis [16]	Sweden	Assuming a mean temperature increase of 2.5–4 °C for the period 1961–2100	Dynamic single-zone energy balance equations in Simulink	National building stock	Typical	Heating energy demand is expected to decrease by 30%. The cooling energy demand is expected to increase but will remain rather low and can be mostly met by natural cooling.

results showed that the heating energy demand during 2081–2100 will decrease by around 25–30% compared to 2011, while the increase in the cooling energy demand can be covered by natural ventilation. Furthermore, Attia and Gobin [17] conducted an assessment of the influence of climate change on thermal comfort in a nearly zero-energy building located in Belgium using three representative concentration pathways (RCP). The results showed that in both static and adaptive thermal comfort models in 2050 and 2100 scenarios, the number of overheating hours exceeded the allowable upper thresholds for discomfort hours in residential buildings.

The present paper aims to propose a framework to assess the impact of climate change on daily, monthly and annual heating and cooling energy demands using a multi-zone approach applied to the building stock in Belgium, using the MAR regional atmospheric model that shows a high spatial resolution (5 km) [18]. This MAR model has been validated over the Belgium territory. This study utilizes multiple weather datasets, including one generated by a reanalysis model covering the historical period (2000–2020) and three generated by Earth System Models (ESM) encompassing the historical (1980–2014) and future periods (2015–2100) under various future scenarios. These datasets are used to generate diverse future projections and assess associated uncertainties for different SSP scenarios, namely SSP5-85, SSP3-70, and SSP2-45. The paper also develops the tree structure model that represents the residential building stock in Belgium initiated by Gendebien et al. [19], considering the updated measures to meet the renovation targets in Belgium by 2050. The final building stock is divided into 752

cases representing 4,675,433 buildings in the base scenario in 2012 which increases by 0.348% in 2050 to reach 6,152,311 dwellings in the business-as-usual (BAU) scenario by considering annual rates for demolition, construction and renovation.

The findings in this study address an increasing need among researchers and policymakers to look into how evolving weather patterns in the future will affect energy demand, particularly for cooling.

The paper is structured as follows. Section 2 presents the methodology of the study. The conceptual framework is presented in section 2.1. The building stock tree structure is presented in section 2.3, the base scenario in (section 2.3.1) and the BAU scenario – up to 2050 in (section 2.3.2). Climate data is provided in section 2.4. The thermal model used to calculate the heating and cooling demands is presented in section 2.5. The results for the evolution of climate and the evolution of heating and cooling energy demands are shown in section 3, while section 4 discusses the key findings of the paper, strengths, and limitations and suggests the potential future research of the ongoing study. Section 5 concludes the paper.

2. Methodology

2.1. Conceptual framework

The conceptual framework used in this study is structured into four parts that guide the calculation and analysis of heating and cooling energy demands in the building stock, as shown in Fig. 1. This

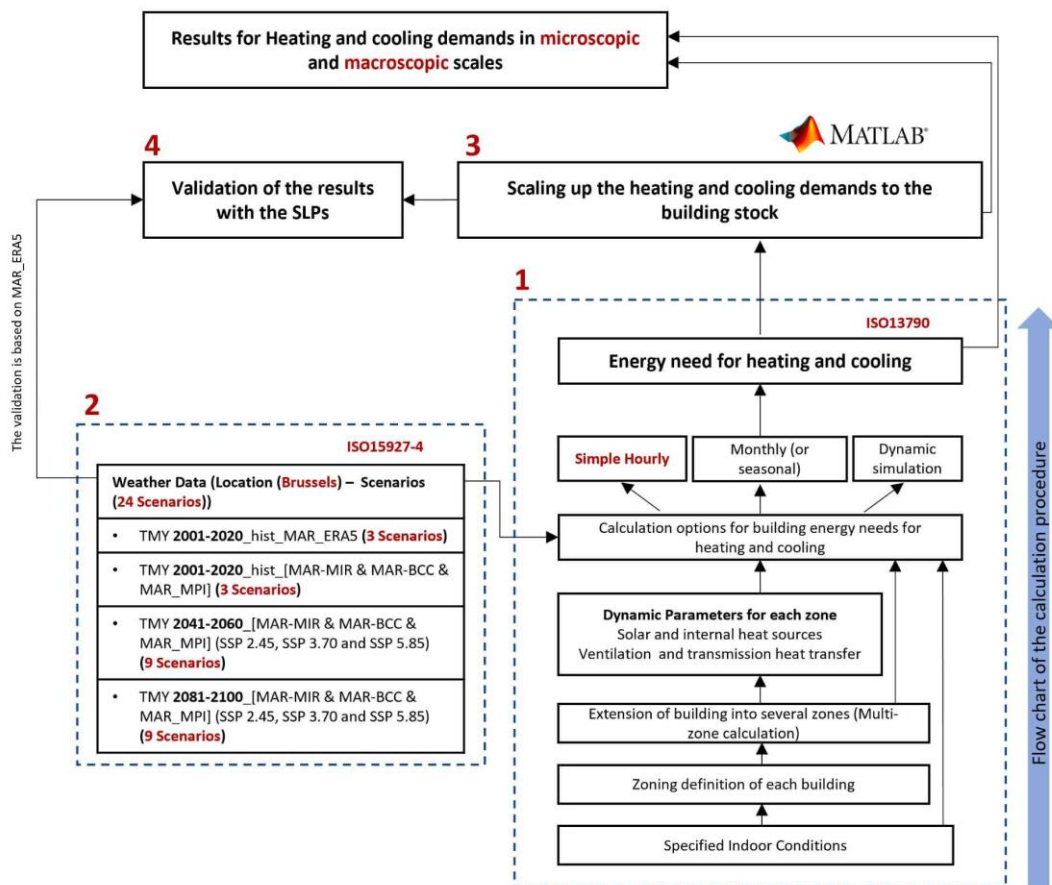

Fig. 1. Conceptual framework of the study.

framework offers a comprehensive and systematic approach to estimating the energy demand for the heating and cooling of buildings.

1. The first part, which is based on ISO 13790:2007, outlines the procedures involved in computing the energy requirements for heating and cooling. This section highlights the crucial steps that must be considered, such as defining the indoor conditions, zoning of each building, and the extension of the building into several zones (if the multi-zone approach is used). Additionally, it includes the dynamic parameters for each zone and the calculation options for building energy needs, whether it's simple hourly, monthly (or seasonal), or dynamic simulation. This study uses a simple hourly method which is a simplified dynamic simulation model with the same level of transparency and robustness as shown in [section 2.5.1.1](#).
2. The second section specifies the weather data that is used in the calculations (based on ISO15927-4). In this study, the weather data for Brussels in the mid-term and long-term future scenarios through different emission scenarios are used, as explained in [section 2.4](#).
3. The third section scales the heating and cooling needs from a single building to the building stock, utilizing the building stock model represented in the study (see [section 2.3](#)).
4. Finally, the fourth part focuses on validating the data obtained from the previous three sections. It involves comparing the results with real data and verifying the model's accuracy.

In addition to assessing the impact of climate change on heating and cooling energy demands on a macroscopic approach for the building stock, the study also included an assessment of the potential impact of climate change on heating and cooling energy demands at the building scale. Additionally, the study evaluated the impact of climate change on different archetypes of buildings, taking into account their insulation characteristics and other relevant factors using a microscopic approach.

To enhance the robustness and credibility of our framework, step 2 of the framework considers the uncertainty of climate by conducting three MAR simulations: medium, hottest, and coldest. These simulations encompass a range of climatic conditions to account for the inherent variability and uncertainty in climate projections. It is important to note that the MAR model used in this study has been thoroughly validated over the Belgium territory, as explained in [section 2.4](#). Additionally, the study assesses associated uncertainties for different SSP scenarios. These scenarios represent different future SSPs that are commonly used in climate change research. The SSP5-85 scenario represents a high greenhouse gas emissions pathway, SSP3-70 represents a moderate emissions pathway, and SSP2-45 represents a low emissions pathway.

Furthermore, in step 3, when scaling up the results to the building stock, the study acknowledges the existence of uncertainties related to the renovation scenarios applied in Belgium. The uncertainty of the building stock is primarily influenced by the choice of renovation scenarios. These scenarios represent a range of possible outcomes, encompassing both optimistic and low renovation rates. [Section 3.2.3](#) addresses this uncertainty by performing uncertainty analysis through eight different renovation scenarios for the Belgian building stock.

2.2. Top-down and bottom-up approaches

There are two approaches to describe the building stock model: top-down and bottom-up [20,21]. The top-down approach, in most cases, is utilized to study the connections between the energy end economic sectors [22], while there is no consideration given to end-use or

potential improvements at the building stock level to assess the impact of various changes on energy performance [19,22]. The bottom-up approach starts with disaggregated buildings or building components and works its way up to the building stock level [21]. Therefore, it requires a large database of actual data to represent the building stock components [23]. As a result of the bottom-up approach, a very accurate building stock model with a high level of detail is produced [24]. The bottom-up approach is quite helpful for determining the energy consumption of existing building stocks, according to Reiter & Marique [22].

Worldwide, several studies were conducted using the bottom-up approach. In the US, Huang and Brodrick [25] used a bottom-up engineering approach to estimate the aggregate building energy end-use for commercial and residential buildings. Another study by Langevin et al. [26] discussed that all newly constructed buildings, as well as various existing building stock energy use intensities, are estimated using bottom-up appliance distribution models. Additionally, Ghedmasi et al. [27] used the bottom-up approach for modelling and predicting energy usage in Algerian residential buildings until 2040.

In Belgium, top-down and bottom-up approaches have been used in different steps of the same assessment. In addition to the necessary attributes from cadastral data, Nishimwe and Reiter [28] used the outputs of the top-down approach as the input data for the bottom-up approach. The mapping of heating consumption and heating energy demand on different scales in Wallonia utilized the outputs of the bottom-up approach. In another study, Reynders et al. [29] developed a reduced-order bottom-up dynamic model of the building stock to assess the potential for demand-side management through the structural storage capacity of buildings in Belgium.

The approach used in this paper adopted a bottom-up methodology to characterize the residential building stock in Belgium. As a first step, a dynamic multi-zone model was implemented to calculate heating and cooling energy demands. Secondly, a tree structure characterizing the residential building stock typology was developed, as shown in detail in [Section 2.3](#). Following that, energy load profiles were created and calibrated to the Belgian context using stochastic probability curves. Lastly, the evolution of the building stock till 2050 following the new development trends was created to investigate the penetration of new technologies in the market while taking into consideration the renovation of the old buildings and also the newly constructed buildings.

2.3. Building stock structure

As part of this study, a tree structure model representing the residential building stock in Belgium has been developed within the framework. This tree structure can also be used as a tool to evaluate the impact of various penetration scenarios of HVAC technologies on electricity and gas load profiles at a national scale [30] and the annual consumption of the building stock [31]. Protopapadaki et al. [32] compared the aforementioned residential building stock with the TAB-ULA one [33] to identify their differences and investigate how variations in the representation of building stock can influence the outcome of bottom-up modelling.

The architecture of the used tree structure is shown in [Fig. 2](#). The entire housing stock is represented in two scenarios (base and BAU), as explained in [section 2.3.1](#) and [section 2.3.2](#), respectively.

Based on this building stock tree structure, the distribution of average U-values for walls and windows are shown in [Fig. 3](#), along with their respective proportions within the building stock.

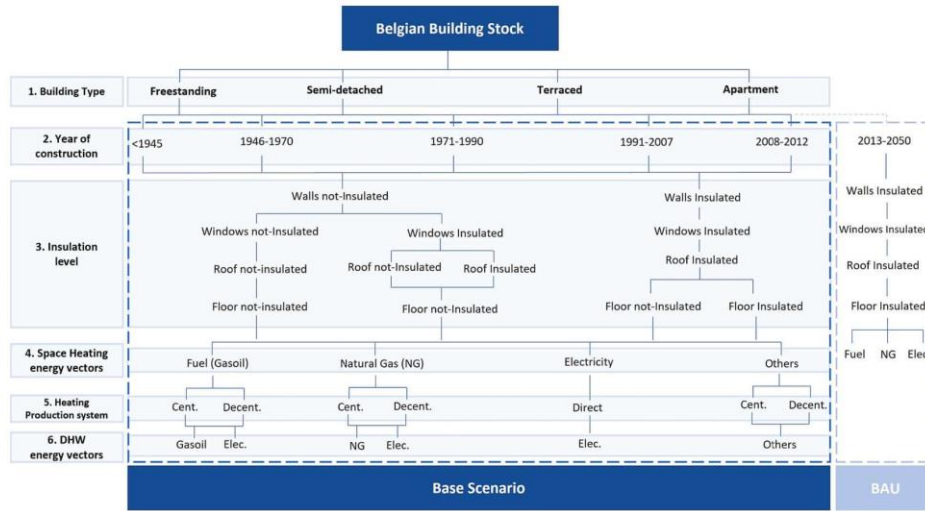

Fig. 2. Belgian residential building stock tree structure.

In this study, a “hybrid approach” is used, which combines elements of both the representative and typical approaches. There is a distinction between the two approaches used in the building stock typology: the “representative approach” and the “typical approach”, as explained by Cyx et al. [33].

- The representative approach entails modelling a set of fictional buildings with average characteristics (U values, average efficiencies and different energy vectors) that represent the entire building stock. The parameters of these fictional buildings are adjusted to align with the energy consumption of the overall building stock, as recorded in energy balances.
- The typical approach, on the other hand, involves extending the characteristics of a typical building to a set of buildings that closely resemble existing buildings and their components [33–35]. These typical buildings are selected based on their representativeness in relation to the building stock, and actual buildings and their characteristics serve as the basis for this process. This approach provides a more detailed and specific picture of the building stock and allows for the examination of the impact of various energy-saving measures on specific individual dwelling types.

In the present work, the hybrid approach combines the strengths of each approach which allows for a balance between the general overview provided by the representative approach and the detailed information provided by the typical approach. The use of a hybrid approach provides

a comprehensive understanding of the building stock and its energy consumption patterns, taking into account both average values and specific individual dwelling types. The hybrid approach addresses a weakness of the typical approach, which only investigates one case for a type of building. The hybrid approach overcomes this limitation by considering a set of several U values for different buildings, depending on the insulation level, for each type of building. Additionally, the hybrid approach has been validated for the Walloon housing stock, confirming its reliability for annual energy use [36].

The creation of the largest building stock tree structure involves considering all possible cases based on available statistics, leading to a significant number of investigated cases and the reliance on numerous assumptions, which takes more than two days to simulate all the cases for only one year. Due to this fact, simplifications need to be introduced.

After several simplifications, the tree structure is developed using a number of references. A set of 4 building types (freestanding, semi-detached, terraced and apartments) in four construction periods (pre-1945, 1946–1970, 1971–1990 and 1991–2007) taken from the work of Allacker [37] have been selected to represent the different building types for each age class. The existing plans are used to determine the geometry of the buildings. From the SuFiQuaD project [38], the share of each type of building in the overall stock was taken and updated using available information from the Belgian National Institute of Statistics [39]. The study by Kints provides information on the ratio of insulated to uninsulated building materials (walls, windows, roofs, and floors) according to the types and ages of buildings [40]. The TABULA study

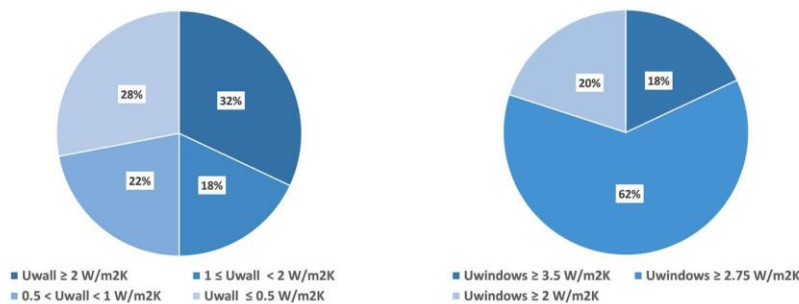

Fig. 3. U-values repartition for walls and windows.

provides information on the composition of uninsulated elements [33]. With the use of a weighted average of values provided by Kints et al. [40], the insulation levels for levels of walls, roofs, and floors were calculated. Additionally, the TABULA framework considered five construction periods by adding an additional period (2008–2011).

The methodology developed to create the tree structure is described in detail in the paper of Gendebien et al. [19]. In order to reflect the various typologies and age classes, the geometrical qualities of 16 typical buildings have been expanded to a set of buildings. The 16 typical buildings are represented by four types of buildings (freestanding, semi-detached, terraced and apartments) and five construction periods in the base scenario (pre-1945, 1946–1970, 1971–1990, 1991–2007 and 2008–2012) as shown in Fig. 2, while considering the same building geometry reference in the two construction periods (1991–2007 and 2008–2012). Within the same construction period and associated building geometry, the tree structure model further distinguishes various scenarios based on factors such as insulation level, the type of energy source used for space heating and domestic hot water (DHW), and the choice between centralized heating production systems (such as boilers) and decentralized heating production system (such as electric resistive heaters and gas convectors). The efficiency of heating production systems depends on whether both space heating and DHW are produced using the same energy source. In centralized systems, where space heating and DHW use the same energy source, their production efficiencies are set to the same value, with the boiler efficiency being influenced by the construction year. However, if DHW is produced using a different energy source, which is electricity, the production efficiency is set to 100%, taking losses into account in the tank model. In decentralized systems, where DHW is produced using a different energy source than space heating (excluding electricity), the efficiency is fixed at 0.9, regardless of the building's age.

The final structure of the building stock tree is determined by considering six parameters:

1. Building type: it categorizes buildings into freestanding, semi-detached, terraced, and apartments.
2. Year of construction: buildings are classified based on the periods they were constructed, including pre-1945, 1946–1970, 1971–1990, 1991–2007, 2008–2012, and 2013–2050 (for the BAU scenario).
3. Insulation level: this parameter describes the insulation level of the building envelope for walls, windows, roofs, and floors.

4. Space heating energy vectors: these indicate the energy sources used for space heating, such as fuel, natural gas (NG), electricity, and other alternatives such as coal or wood.
5. Heating production system: this parameter differentiates between centralized and decentralized heating systems.
6. DHW energy vectors: these represent the energy sources utilized for DHW, including fuel, NG, electricity, and other alternatives like coal or wood.

2.3.1. Base scenario

The base scenario is divided into 752 cases representing 4,675,433 buildings. There have been 202 cases studied in each of freestanding, semi-detached, and terraced homes and 146 cases in apartments. Fig. 4 (a) shows the distribution of Belgian dwelling types across five different construction periods in the base case, while Fig. 4 (b) presents the percentage of dwellings driven by different energy sources utilized for space heating. The majority of buildings are fulfilled by NG, accounting for 50.14% and fuel boilers for 40.02%. Meanwhile, electricity and other energy sources have a relatively smaller distribution, representing 5.76% and 4.08%, respectively. The building stock base scenario does not currently incorporate active cooling systems.

The base scenario discussed here is concerned with studying the evolution of heating and cooling energy demands with climate change but without the implementation of any demolition or renovation strategies. This scenario aims to assess the current building stock and understand how it will perform under changing climatic conditions without any interventions to improve energy efficiency.

2.3.2. Business-as-usual scenario (up to 2050)

The BAU scenario consists in updating the building stock up to 2050. The tree structure representing the building stock in 2012 was turned into an evolutionary tree structure, allowing for simulations of potential changes in the building stock over time. This involved considering annual rates of demolition, construction, deep retrofit, and shallow retrofit. The tree structure is initially updated to incorporate the newly constructed and demolished buildings from 2013 to 2050. In line with the long-term renovation strategies of Brussels, Wallonia, and Flanders in Belgium, the average annual rates of construction and demolition are set at 0.9% [39,42–44] and 0.075% [45], respectively. The total number of buildings for the year 2050 can be deduced from Eq. (1) [19]:

$$N_{2050} = N_{2012}(1 + (x_{con} - x_{dem}))^t \quad (1)$$

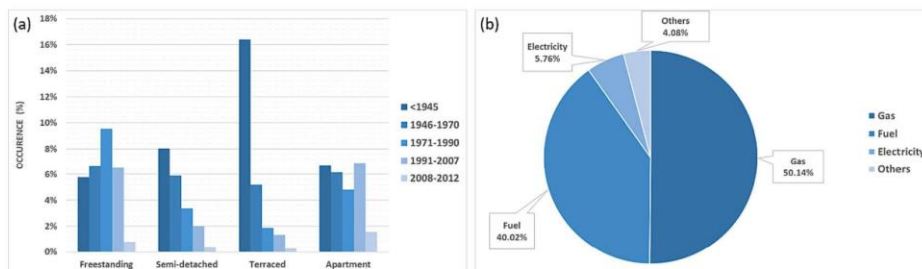

Fig. 4. Base scenario (a) distribution of the Belgian dwelling types by the five construction periods (b) percentage of dwellings driven by different energy sources for space heating [41].

With:

- N_{2012} : total number of buildings in 2012;
- N_{2050} : the total number of buildings in 2050;
- X_{con} : annual construction rate;
- X_{dem} : annual demolition rate;
- t : number of years considered (i.e. $t = 38$ years).

In the study, two renovation strategies have been considered - deep renovation and shallow renovation.

- Deep renovation refers to implementing extensive insulation measures across all components of a building, encompassing walls, windows, roofs, and floors. This strategy aims to improve the overall energy efficiency of the building, reducing heat loss and improving indoor comfort.
- On the other hand, shallow renovation is a more limited renovation strategy that focuses on the insulation of roofs and windows according to the Energy Performance of Buildings (EPB) Directive 2010 [46]. This strategy is intended to reduce heat loss through the roof and windows, which are typically the main sources of heat loss in a building. Shallow renovation can be considered a cost-effective alternative to deep renovation, particularly for buildings that are already well-insulated.

It has been assumed that priority was given first to the oldest non-insulated buildings (deep renovation) and, in the second time to the partially insulated buildings (shallow renovation).

Additionally, due to the uncertain renovation rates in the future, uncertainty analysis is carried out for various renovations. The renovation and demolition strategies can vary greatly depending on factors such as government regulations, consumer behaviour, and the availability of funding. As a result, it can be difficult to predict the exact renovation rate that will be achieved in the future. The study conducts an uncertainty analysis to assess the impact of the uncertain range of renovation rates on heating and cooling energy demands through eight renovation scenarios, as shown in Table 2. The table shows different scenarios with different rates of demolition, shallow renovation, and deep renovation. The total renovation rate represents the sum of the shallow and deep renovation rates.

Scenario 1 is the reference scenario, where all types of renovation are

considered, and the rates are set at 0.075% for demolition, 0.8% for shallow renovation, and 0.5% for deep renovation, resulting in a total renovation rate of 1.3%. The renovation rate in the reference scenario is calculated based on the average number of retrofit grants awarded in the last 20 years in the Brussels region and then extended to the national building stock in Belgium [39,47]. However, to cover the uncertain range of renovation rates, other scenarios (scenario 2 to scenario 8) are used. These scenarios vary in the rates of renovation, ranging from very pessimistic scenarios with a 0% renovation rate to very optimistic scenarios where all building stocks are renovated with the maximum renovation rate. The purpose of these varied scenarios is to explore a wide range of possibilities and assess the impact of different renovation rates on the overall outcomes. Scenario 2 in the table shows the case where no buildings are renovated, but the demolition rate remains at 0.075%. This is essentially a BAU scenario, where no effort is made to reduce the energy demand of buildings through renovation. Scenario 3, on the other hand, assumes a higher demolition rate of 0.22% but also no renovation. This scenario implies a higher rate of demolishing older buildings and replacing them with new buildings that may have better energy efficiency, but still, no effort is made to retrofit or improve the energy efficiency of existing buildings. Scenario 4 has a moderate total renovation rate and a balanced distribution of shallow and deep renovation. Scenario 5 has a high deep renovation rate and no shallow renovation. Scenario 6 has a high shallow renovation rate and no deep renovation. Scenario 7 has a high total renovation rate and a relatively balanced distribution of shallow and deep renovation. Scenario 8 has the highest deep renovation rate and no shallow renovation. Scenario 8 has the highest shallow renovation rate and no deep renovation. The main difference between these scenarios is the allocation of renovation types and rates, which leads to different levels of energy demand and greenhouse gas emissions. The common factor in all scenarios is the implementation of renovation strategies to reduce energy demand and greenhouse gas emissions from buildings.

The expected distribution of dwellings in 2050 is shown in Fig. 5 (a). The number of dwellings for the reference year 2012 was 4,675,433 and reaches 6,152,311 dwellings in 2050. Fig. 5 (b) shows the percentage of dwellings driven by different energy sources used for space heating. The electricity share is 18.20% compared to 5.76% in the base scenario. This increase is attributed to various policies and regulations aimed at

Table 2
Different renovation scenarios for the Belgian Building stock.

Scenarios	Demolition rate [%]	Shallow renovation rate [%]	Deep renovation rate [%]	Total renovation rate [%]
Scenario 1 (reference)	0.075	0.8	0.5	1.3
Scenario 2	0.075	0	0	0
Scenario 3	0.22	0	0	0
Scenario 4	0.075	0.4	0.25	0.65
Scenario 5	0.075	0	1.3	1.3
Scenario 6	0.075	1.3	0	1.3
Scenario 7	0.075	0.95	0.85	1.8
Scenario 8	0.075	1.95	0	1.95

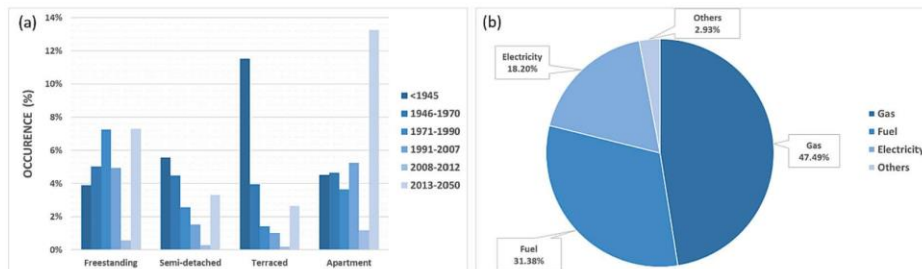

Fig. 5. BAU scenario (a) distribution of the Belgian dwelling types by the six construction periods (b) percentage of dwellings driven by different energy sources for space heating [41].

promoting the use of electricity and banning the use of oil boilers for newly constructed buildings and NG connections for large apartments as well. Even in the BAU scenario, the electricity share refers to the buildings that are driven by electric resistive heating systems for space heating, while heat pump systems and their impact on the final energy consumption in the Belgian residential building stock were studied by Elnagar et al. [41] in a different study as part of the framework of this study. Additionally, the share of NG and fuel is also reduced compared to the base scenario in 2012.

The BAU scenario takes into account the potential reduction of total demand due to retrofit strategies. By comparing the results of the BAU and Base scenarios, the effectiveness of retrofitting can be assessed in terms of reducing the total demand and mitigating the impact of climate change on buildings in the future since both the base scenario and the BAU scenario consider the impact of climate change on the heating and cooling energy demands of the building stock.

Table A.1 and Table A.2 in Appendix A show more details and the parameters used for modelling to obtain a more detailed understanding of the building stock. It is also recommended to read the study and the model description by Gendebien et al. [19].

2.4. Climate data

The regional climate model used in this study is the “Modèle Atmosphérique Régional” model (hereafter called “MAR”) in version 3.11.4 [18]. MAR aims to downscale a global model or reanalysis with a resolution of ~ 100 km/6_h and ~ 30 km/3h, respectively, to get weather outputs at a finer spatial and temporal resolution, typically 5 km/1_h. For more information about the MAR model, the reader is invited to check Doutreloup et al. (2022) [18]. This model has been validated over the Belgium territory by several studies [48–51]. For this study, the spatial resolution of MAR is 5 km over an integration domain (120×90 grid cells) centred over Belgium, as shown in Fig. 6.

This MAR model, like any regional climate model, must be forced at its boundaries by a global model (i.e. ESM), whether a reanalysis model. Firstly, the MAR model is forced by ERA5 (called hereafter MAR-ERA5 [52]) in order to have past simulation (1980–2020). As the ERA5 reanalysis model is forced by different kinds of observations, MAR-ERA5 can be considered the simulation closest to the observed climate.

Secondly, the MAR model is forced by three Earth System Models

(ESM) coming from the Sixth Coupled Model Intercomparison Project (CMIP6 [2]). The choice is based on two criteria: ESM should represent (with the lowest possible bias) the main atmospheric circulation in the free atmosphere over Western Europe with respect to ERA5 over 1980–2014, and the three choosing ESMs must represent the CMIP6 models spread in 2100 for the same scenario (SSP5-8.5 in this study) [18]. For this study, the ESMs: BCC-CSM2-MR (MAR-BCC) [53], MPI-ESM.1.2 (MAR-MPI) [54] and MIROC6 (MAR-MIR) are selected [55].

These ESMs are not forced by observation and represent only the mean evolution of climate according to different kinds of carbon emissions and thus according to different kinds of socio-economical scenarios called Shared Socioeconomic Pathways (hereafter called SSPs [8]). Except for MAR-MIR, which noticeably overestimates summertime temperatures and solar radiation, MAR simulations successfully capture the current climate and its interannual variability. The ensemble mean of all MAR simulations is MAR-BCC, and MAR-MPI can be thought of as the MAR simulation that is the coldest. As a first step, MAR is forced by the ESM according to their historical scenario (1980–2014) to obtain a possible comparison with MAR-ERA5. In a second step, MAR is forced by the ESM according to their most warming scenario, namely the SSP5-8.5 scenario, in order to obtain the future climate evolution (2015–2100).

The specificity of these simulations is that to save computation time, the SSP5-8.5 scenario is used to reconstruct the SSP3-7.0 and SSP2-4.5 scenarios, as explained by Doutreloup et al. [18]. Indeed, the climate evolution included in SSP5-8.5 also contains the climate evolution of SSP3-7.0 and SSP2-4.5 but in different periods since the ESMs do not simulate general atmospheric circulation changes [57]).

The Typical Meteorological Year (TMY) reconstructed for this study are datasets that are widely used by building designers and others for modelling renewable energy conversion systems [58]. The TMY files are the synthetic years (on an hourly basis) constructed by representative typical months [59], which are selected by comparing the distribution of each month within the long-term (minimum ten years) distribution of that month for the available modelled data (using Finkelstein-Schafer statistics [60]). Many methods exist to reconstruct this kind of weather file [61], but for this study, a protocol for the construction of these typical years has been developed based on ISO15927-4 [62] and is described in Doutreloup et al. [18].

To enhance the study’s findings’ reliability within uncertain climate conditions, a key step was considered in relation to the weather data

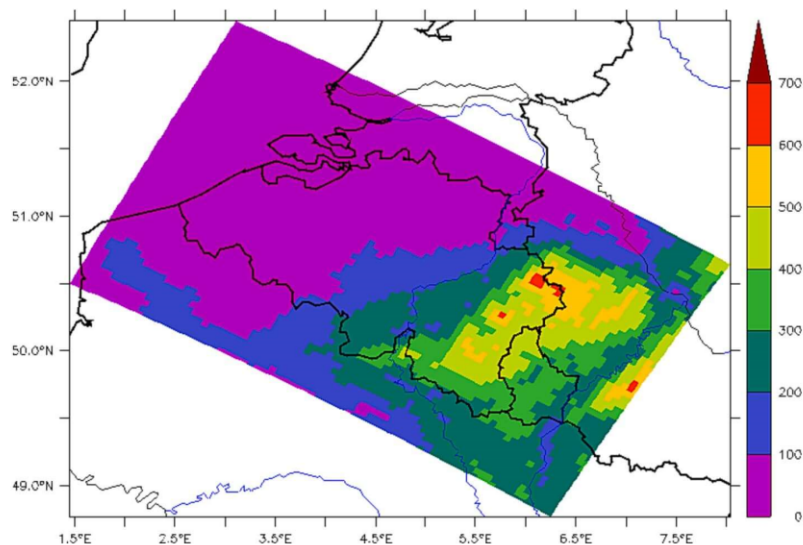

Fig. 6. Topography (in meters above sea level) of the MAR domain representing Belgian territory [56].

within the framework of the study. In addressing the inherent uncertainty of global climate models, three ESMs have been used to obtain an initial approximation of the range of possible outcomes. This approach helps to provide a broader picture of the possible range of future climate scenarios without having to downscale all 30 available models of the CMIP6.

2.5. Energy demand for heating and cooling

2.5.1. Building thermal model

According to ASHRAE [63], there are two types of building modeling methods: forward and data-driven. This study uses a forward method for building energy use with a physical description of various parameters (e.g., building geometry, location, characteristics, and operating schedules). The forward model is more suited for improvements due to its higher level of detail.

This study uses a dynamic multi-zone model which takes into account the interaction between the different zones of the buildings, whether they are humid or dry. In addition to that, setting different set-point temperatures in the different zones allows an accurate calculation of the indoor heating and cooling energy demands.

2.5.1.1. Zone thermal model. The simplified building model of a zone is based on the simple hourly time step method described in ISO 13790:2007 [64]. The method is based on the thermal-electrical analogy between the analysed thermal zone and the equivalent 5R-1C (5 resistances and 1 capacity) network, as shown in Fig. 7 [65]. The model uses an hourly time step and allows a high flexibility level of detail accuracy while still being relatively straightforward to implement. However, it can also be computationally intensive, requiring a large number of calculations to be performed for each hour of the simulation. The simple hourly method calculates the energy demand of a building by using a series of hourly calculations to simulate the heat transfer through the building envelope and the thermal storage of the building structure.

This allows for a detailed simulation of the heating and cooling energy demands of a building over time, taking into account factors such as the temperature and weather conditions outside the building and the insulation properties of the building envelope.

It is acknowledged that ISO 13790:2007, which utilizes the 5R1C method, has been replaced by ISO 52016-1, which introduces a more comprehensive model with several resistances and capacitances for each building element. However, it is important to note that the use of ISO 13790:2007 in our work was not without consideration. ISO 13790:2007, with its simple hourly method (5R1C method), has been widely used and validated in previous studies. Numerous studies demonstrated the reliability and practicality of the 5R1C method in estimating heating and cooling energy demands in buildings [66–68]. Additionally, ISO 13790:2007 is more simple and requires less computational time compared to the new ISO 52016-1, especially while dealing with a building stock model with numerous cases [69].

The thermal-electrical network is characterized by temperature nodes (θ), thermal resistances ($1/H$), heat fluxes (Φ) and a capacity (C_m).

The calculation approach is based on heat transfer simplifications between the internal and external environment. Solar and internal heat gains are distributed over different nodes, as shown in Fig. 7: the internal air node θ_{air} , the surface node θ_s and the mass node θ_m . The five resistances in the 5R1C network allow describing the heat transfers coefficients (expressed in Watts per Kelvin) as follows:

- Heat transfers due to ventilation H_{ve} , which is connected to the air temperature node θ_{air} and the supply air temperature θ_{sup} (R1).
- Heat transfer by thermal transmission $H_{tr, is}$ due to thermal conductance (between air temperature node θ_{air} and the surface temperature node θ_s) (R2).
- Heat transfer by thermal transmission through windows $H_{tr, w}$ (R3).
- Heat transfer by transmission through opaque components $H_{tr, op}$, which is divided into $H_{tr, em}$ and $H_{tr, ms}$ (R4 and R5) [66].

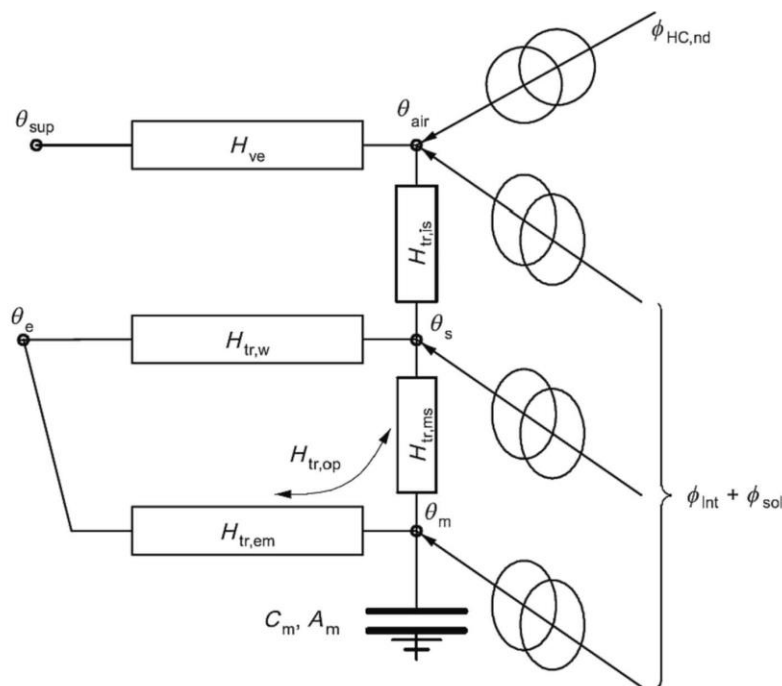

Fig. 7. The equivalent 5R-1C network based on the simple hourly method of EN ISO 13790:2007 [64].

- o $H_{tr,em}$ represents the external part of the heat transfer coefficient by the transmission for the non-window part of opaque elements.
- o $H_{tr,ms}$ represents the internal part of the heat transfer coefficient by the transmission for the non-window part of opaque elements.

The thermal mass is represented by a single thermal capacity C_m . The 5R-1C network also includes the heat flow rate due to internal heat source Φ_{int} and heat flow rate due to solar heat source Φ_{sol} split over the three temperature nodes.

Overall, the five resistances in the 5R1C model represent thermal resistance due to the building's envelope, and they are tuned based on the building's geometry and construction properties. While the capacitance represents the thermal mass of the building, and it is tuned based on the building's construction materials and volume.

2.5.1.2. Extension to several zones. In the current study, a multi-zone approach is adopted to analyse the heating and cooling energy demands in buildings. The multi-zone calculation is carried out without thermal coupling between zones, i.e. no heat transfer by thermal transmission or ventilation between zones is considered. The multi-zone approach has also been used in previous studies in Belgium and worldwide [19,30,70]. There are a total of five zones that have been defined in all buildings for this purpose, which are:

- 1- Living area: this zone includes the living room and kitchen.
- 2- Sleeping area: this zone encompasses the bedrooms.
- 3- Bathroom: this zone is dedicated to the bathroom.
- 4- Circulation zone: this zone is used for circulation purposes and includes the hallways and staircases.
- 5- Unconditioned zone: this zone encompasses all other areas in the building that are not conditioned for heating or cooling, such as attics, garages, or storage spaces.

The heating and cooling loads for the first four zones (living area, sleeping area, bathroom, and circulation zone) are determined through the RC network described in the previous section. The total energy demand for heating and cooling is the sum of the energy demand calculated for the individual zones, as explained in detail in ISO 13790:2007 [64]. This approach allows for a detailed analysis of the energy requirements in each of these zones, enabling the identification of areas where energy-saving measures can be implemented effectively.

2.6. Calculation of the internal temperature required for heating and cooling needs

In this section, the process for calculating the internal temperature and required heating or cooling power for a given hour in a building zone is described based on ISO 13790:2007 [64]. To calculate the internal temperature for any amount of heating or cooling need $\Phi_{HC,nd}$ for each hour, the RC network enables the determination of the internal temperature as a linear function of $\Phi_{HC,nd}$. Fig. 8 shows the heating setpoint temperature $\theta_{int,set,H}$, cooling setpoint temperature $\theta_{int,set,C}$ and the maximum available heating and cooling power, which can change hourly. Five potential cases can occur based on this calculation.

- Insufficient heating power: building needs heating but not enough power. The heating need, in this case, will be limited to the maximum power provided ($\Phi_{H,max}$), and the internal temperature will be lower than the heating setpoint.
- Sufficient heating power: building needs heating, and there is enough power, the temperature reaches the heating setpoint. In this case, the calculated heating need is less than the maximum power.
- Free-floating conditions: building neither needs heating nor cooling.
- Sufficient cooling power: building needs cooling, and there is enough power, the temperature reaches the cooling setpoint. In this case, the calculated cooling need is less than the maximum power.

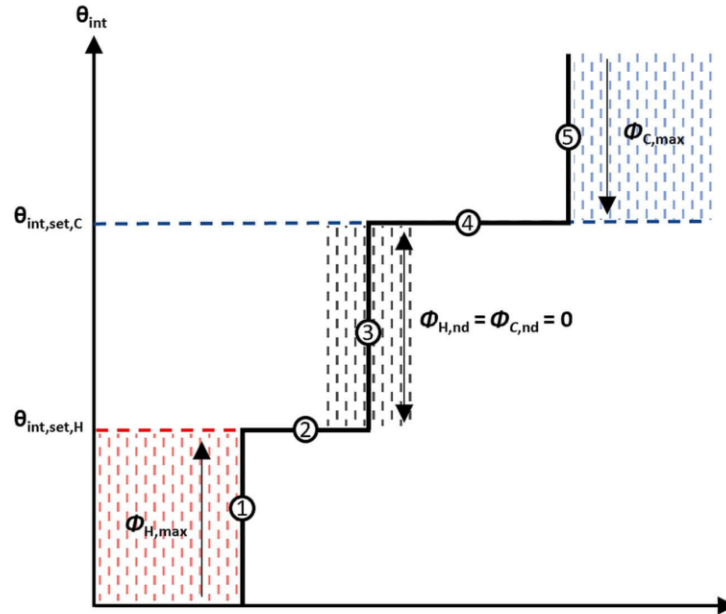

Fig. 8. Calculation of internal temperature and required heating or cooling needs.

- Insufficient cooling power: building needs cooling but not enough power ($\Phi_{C,max}$). The Cooling need, in this case, will be limited to the maximum power provided, and the internal temperature will be higher than the cooling setpoint.

2.7. Internal gains and indoor air temperature set points schedule

In addition to the external climate conditions, internal gains are also a crucial factor in determining the heating and cooling loads of buildings. Internal gains are generated from a range of sources, including occupancy, lighting, and the use of appliances. In the present study, internal gains are considered in the building energy simulation model to more accurately capture the overall heating and cooling energy demands of the building [71,72].

One of the primary sources of internal gains is occupancy. In Belgium, households have an average of 2.3 occupants per household [73], and this is used in the simulations to estimate the heat generated by the occupants through their activities, such as body heat and respiration. The total metabolic rate at rest conditions (100 Watts). The perspiration losses in rest conditions are 40 Watts. Sensible gains represent the amount of heat that is transferred to the body through convection and radiation, and they are calculated as the difference between the total metabolic rate and the perspiration losses. The energy need for latent heating and cooling loads is not included in this calculation.

Another significant source of internal gains is lighting, which is accounted for in the simulations by estimating the number of light fixtures and their wattage. Finally, the use of appliances such as refrigerators, TVs, computers, and other household equipment is also taken into account in the simulations to estimate the heat generated by these devices.

The temperature control of a zone involves a set of parameters that determine the comfort level of the occupants. The heating and cooling schedules are designed based on set point temperatures, morning and evening starting times, and durations. The set points are fixed values that dictate the desired temperature in the zone, while the starting times and durations are determined based on Gaussian probabilities characterized by averages and standard deviations, as shown in Fig. B1. These parameters differ for weekdays and weekends to reflect the occupants' different activities and preferences. Moreover, the ISO 17772-1 standard specifies the minimum set point temperature for heating in winter and the maximum set point for cooling in summer, which are 20 and 26 °C, respectively [74].

2.8. Ventilation and infiltration

In the framework of this study, natural ventilation is carried out by infiltrations in buildings which are not perfectly tight. This is the case for most existing dwellings in the building stock. To assess the air change rate per hour for infiltration (ACH) associated with natural ventilation, ASHRAE proposed a simplified method that considers the airtightness level of the building, the site location (suburb, city centre, countryside), wind speed, and building height [75]. The ACH under a pressure difference of 2 Pa pressure difference can be calculated using equation (2):

$$ACH_{2Pa} = K_1 + K_2 * |T_{out} - T_{in}| + K_3 * V_{wind} \quad (2)$$

$$V_{wind} = a + V_{wind,0} * h^b \quad (3)$$

Where T_{out} is the outdoor temperature, T_{in} is the indoor temperature, V_{wind} is the wind speed and K_1 , K_2 and K_3 are given coefficients depending on the level of airtightness (tight, medium and high) as shown in equation (2). Additionally, The wind speed is provided in the weather conditions hourly data but has to be corrected to include the influence of the surrounding environment as follows h is the average building height and a and b are coefficients depending on the site location (suburb, city centre, countryside) as shown in equation (3).

2.9. Model validation

The validation process of the building stock model has been thoroughly undertaken to ensure the accuracy and reliability of its outputs. As pointed out by Ballarini et al. [68], several studies have investigated the reliability of the simple hourly method proposed in ISO 13790:2007 [64]. The results obtained for the estimation of the annual energy demand for heating and cooling with this method were compared with either result of detailed simulation tools such as EnergyPlus [66,76] or real data sets [77]. In all cases, good agreements were found in the results.

In addition, for this study, model validation for the heating energy demand was performed by comparing the model results to a historical data set. The historical data set is based on the "Synthetic Load Profiles (SLPs) in Belgium, which are designed to represent the aggregated consumption of an average dwelling based on a statistical selection of 2500 residential dwellings. These profiles provide data on electricity consumption at a 1/4 hourly resolution and gas consumption at an hourly resolution.

To ensure the accuracy of the model results, firstly, the annual gas consumption profiles in 2019 are shown in Fig. 9 (a), providing a macroscopic view of energy consumption trends over time. Secondly, the focus zooms in to capture the essence of daily consumption patterns, achieved by analysing gas load profiles for an average day, as shown in Fig. 9 (b). The profile is obtained by dividing the actual demand by the total annual demand. Thirdly, the validation is extended to encompass multiple days, where gas load profiles for consecutive days are evaluated, as shown in Fig. 9 (c). This comprehensive validation strategy shows the robustness of the model under varying temporal and usage contexts.

Finally, between the years 2017, 2018, and 2019, the annual consumption per average dwelling, as indicated by the SLPs, ranged from 23.5 to 24.6 MWh, as shown in Fig. 9 (d). The tree-structure building model of this study predicted gas consumption with a relatively small mismatch error of only 4-6% in the three years, which thereby confirmed the conclusions reached by the above-mentioned studies and the previous validation of the model by Georges et al. [30]. In particular, the conversion of heating energy demand to final heating energy consumption is a focal point of the model validation, which includes the heating production systems efficiency, an essential component in reflecting the actual energy consumed by various heating systems. As shown in Table B.1 in Appendix B, this efficiency factor takes into account the efficiency of heating production systems based on the type of energy vector used in SH and DHW and the construction year of the building. Additionally, the percentage and number of dwellings relying on different energy sources for SH and DHW, as shown in Fig. 4, have been integrated into the conversion process.

However, an important practical consideration emerges when validating cooling energy consumption. Given Belgium's temperate climate, active cooling systems are infrequently integrated within the existing building stock, and no data set is available to validate the model at the building stock level further than already achieved by the other studies. As a result, the validation of cooling energy consumption is not a primary focus of this study.

3. Results

3.1. Evolution of climate

The average monthly outdoor temperatures for Brussels for current and future TMYs from MAR forced by BCC-CSM2-MR (MAR-BCC), MPI-ESM1.2 (MAR-MPI) and MIROC6 (MAR-MIR) are shown in Fig. 10, Fig. 11, and Fig. 12, respectively. The TMY for historical scenarios (2001-2020) is used as a reference TMY (the 2010s). The results for MAR-BCC simulation show that the average monthly temperature is expected to increase between 0.5 and 2.7 °C in 2050s_SSP5-8.5

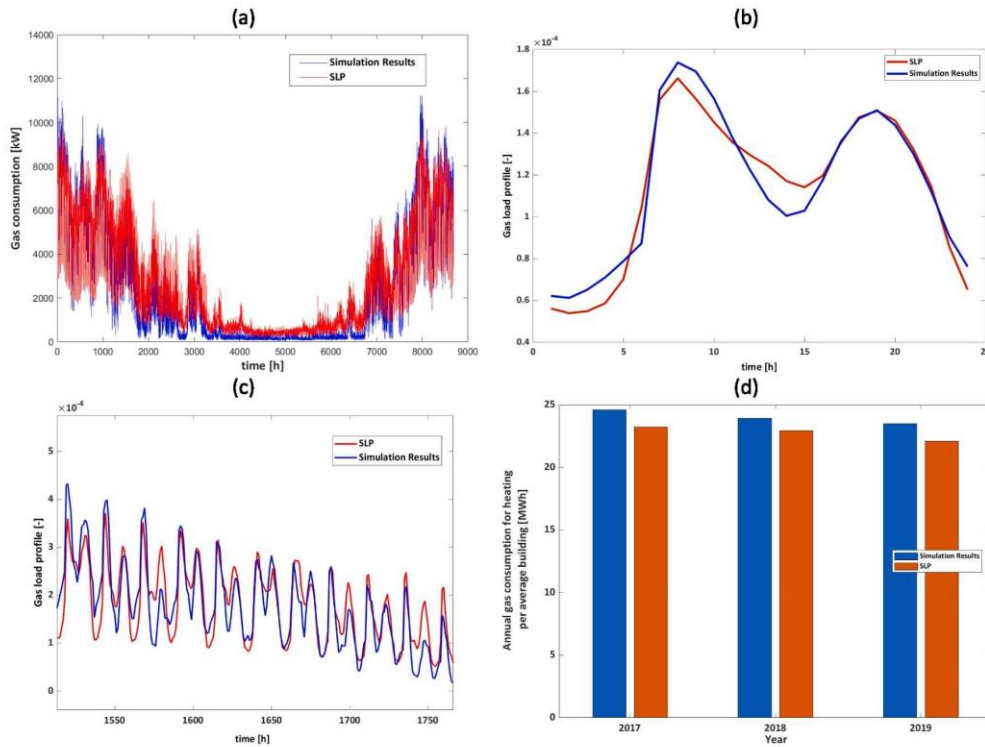

Fig. 9. Model validation by comparing the simulation results and Synthetic Load profiles (SLP) results (a) yearly gas consumption profiles, (b) gas load profiles for an average day [the profile is obtained by dividing the actual demand by the total annual demand], (c) gas load profiles for several consecutive days, (d) average gas consumption per an average building.

compared to 2010s and between 1.1 and 4.1 °C in 2090s_SSP5-8.5 compared to 2010s as shown in Fig. 10. Overall, in the MAR-BCC simulation, the temperature is expected to increase over the years in the different SSP scenarios except in September 2050s in SSP2-4.5, in which the temperature is expected to decrease by 0.24 °C.

In the second MAR simulation (MAR-MPI), which is considered the coldest MAR simulation, as shown in Fig. 11, the temperature is expected to decrease in winter, mainly in December and January, between 1.9 and 2 °C and to increase between 0.9 and 1.4 °C by 2050s in the

summer compared to 2010s. Additionally, the temperature is expected to decrease in winter by 2090s between 0.6 and 2 °C in SSP3-7.0 and SSP2-4.5, respectively, while the temperature is expected to increase in the winter of the SSP5-8.5 scenario in 2090s by 0.6 °C compared to 2010s. In the summer of 2090s, the temperature is expected to increase by 1.3 °C, 2.8 °C and 3.9 °C in SSP2-4.5, SSP3-7.0 and SSP5-8.5, respectively, compared to the 2010s.

The third MAR simulation (MAR-MIR) overestimates summertime temperatures and solar radiation. The results indicate that the average

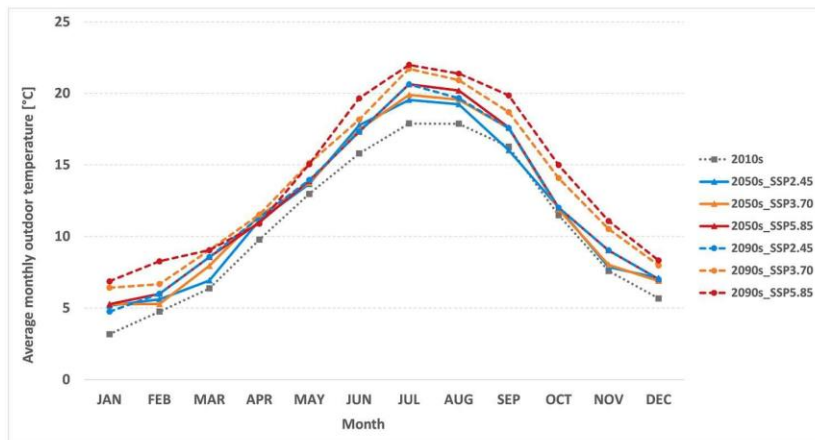

Fig. 10. Average monthly outdoor temperature in Brussels based on MAR forced by BCC-CSM2-MR ESM.

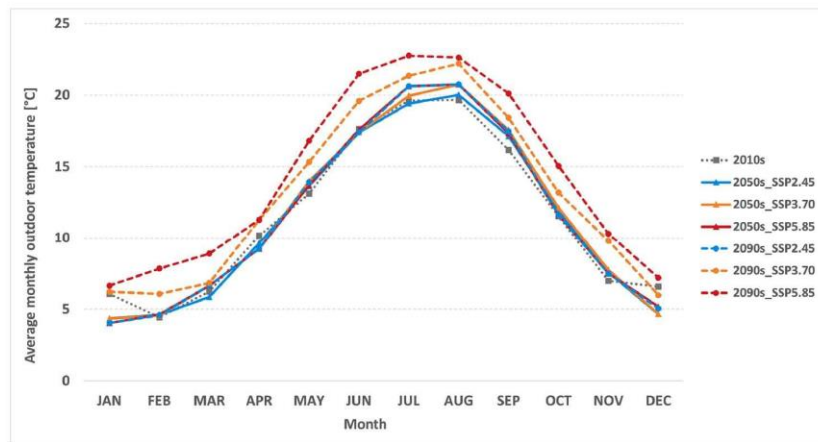

Fig. 11. Average monthly outdoor temperature in Brussels based on MAR forced by MPI-ESM1.2.

monthly temperatures exhibit fluctuations under different scenarios, as shown in Fig. 12. The findings reveal that, particularly in the SSP5-8.5 scenario, there could be a substantial increase in temperature of approximately 9 °C by the 2090s compared to the 2010s.

After assessing the three MAR-ESMs, it was determined that the differences in temperature change were not significant. Therefore, to reduce the computational time required for the simulations and to study the different SSP scenarios as they provide a range of possible futures for different socioeconomic conditions and their impact on climate change. It was decided to use MAR-BCC as the representative scenario for the energy simulations to calculate the future heating and cooling energy demands, as shown in section 3.2.

3.2. Evolution of heating and cooling energy demands

3.2.1. Base scenario

The share of heating and cooling energy demands over the total demand in the base scenario is shown in Fig. 13. The results of the study indicate that there is a notable shift in the demand for heating and cooling in the building stock over time. In particular, the results show that the cooling energy demand share is expected to increase from 6% in the 2010s scenario to 12% in the 2050s and to 16% in the 2090s. Meanwhile, the share of heating energy demand is anticipated to

decrease from 94% in the 2010s scenario to 88% in the 2050s and 84% in the 2090s.

Fig. 14 shows the expected change in the heating and cooling energy demands in the different weather scenarios. Specifically, in the 2050s, the results show that the heating energy demand is expected to decrease by 8%, 11% and 13% in SSP2-4.5, SSP3-7.0, and SSP5-8.5, respectively, compared to the 2010s. In contrast, the cooling energy demand is anticipated to increase substantially, with a 39% increase in SSP2-4.5, a 59% increase in SSP3-7.0, and a 65% increase in SSP5-8.5 compared to the 2010s. Additionally, the heating energy demand in the 2090s is expected to decrease by 13%, 20% and 22% in SSP2-4.5, SSP3-7.0, and SSP5-8.5, respectively, compared to 2010s, while the cooling energy demand is expected to increase by 61% in SSP2-4.5, 88% in SSP3-7.0 and a significant increase by 123% in SSP5-8.5 compared to the 2010s.

These results also showed that the impact of climate change on energy demand varies significantly depending on the type of building. Fig. 15 illustrates the expected change in heating and cooling energy demands for four different building types: freestanding, semi-detached, terraced, and apartment buildings. The results show that the decrease in heating energy demand is expected to be between 13% and 14% by the 2050s and between 22% and 23% by 2090s for all building types compared to the 2010s scenario. However, the increase in cooling energy demand varies for different building types. For freestanding houses,

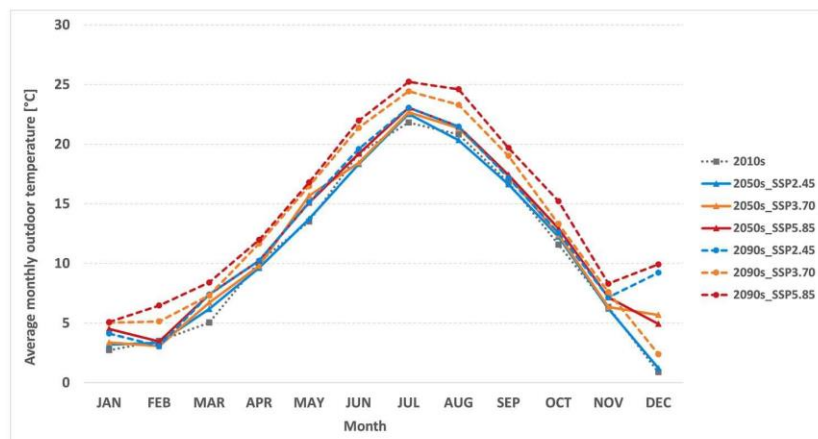

Fig. 12. Average monthly outdoor temperature in Brussels based on MAR forced by MIROC6 ESM.

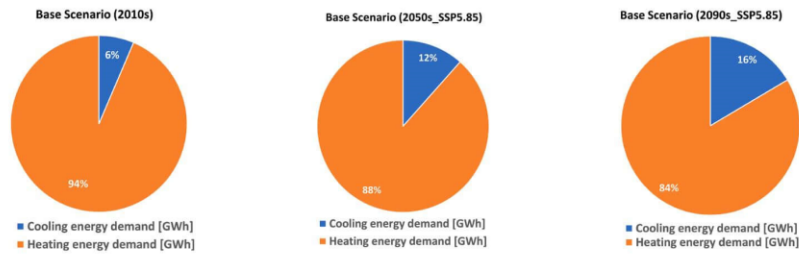

Fig. 13. Share of heating and cooling energy demands in the base scenario.

the cooling energy demand is expected to increase by 70% in the 2050s and 140% by the 2090s compared to the 2010s. For semi-detached houses, the cooling energy demand is expected to increase by 92% in the 2050s and 198% in the 2090s compared to the 2010s. In terraced buildings, the cooling energy demand is anticipated to increase by 77% in the 2050s and 151% in the 2090s compared to the 2010s. Interestingly, the increase in cooling energy demand for apartment buildings is expected to be the lowest among the four types, with an increase of 45% in the 2050s and 72% in the 2090s compared to the 2010s.

3.2.2. BAU scenario

The BAU scenario is based on current trends in the country and takes into account average demolition and construction rates of 0.075% and 0.9% per year, respectively. This means that 0.075% of the building stock is demolished and replaced by new constructions each year, while 0.9% of the building stock is added through new constructions. The

scenario also includes average retrofit scenarios as a baseline, as shown in Table 2, with a 0.8% per year shallow renovation rate and a 0.5% per year deep renovation rate. It should be mentioned that the BAU scenario also considers a wide range of renovation rates for both shallow and deep renovation due to the uncertain rates in the country.

As explained in the base scenario, the study found that there will be a significant change in the requirement for heating and cooling in the building stock over time. This pattern is also observed in the BAU scenario, which is demonstrated in Fig. 16. The BAU scenario considers the effects of demolition, construction, and renovation rates, and the outcomes indicate that by the 2050s, the proportion of heating energy demand will decrease to 14%, while the proportion of cooling energy demand will increase to 86%. This represents a slight variation from the base scenario, which predicts heating and cooling energy demand proportions of 12% and 88%, respectively. Furthermore, by the 2090s, the cooling energy demand is expected to reach 19%, while the heating

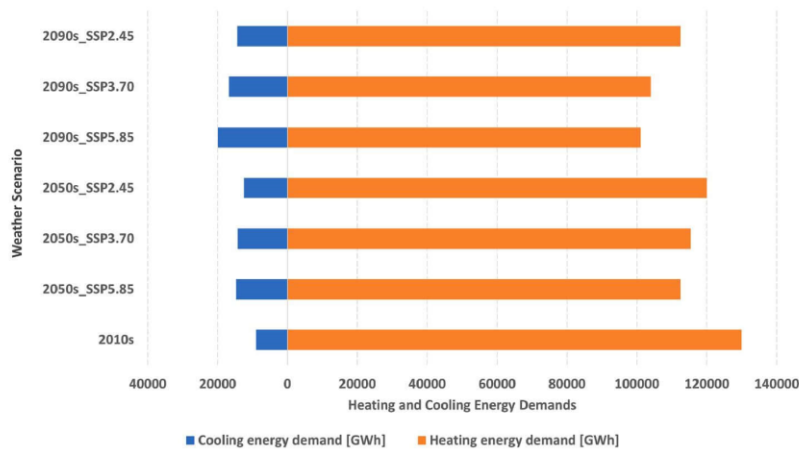

Fig. 14. Heating and cooling energy demands in the Base scenario [Comparison between the 2010s, 2050s for SSP2-4.5, SSP3-7.0 and SSP5-8.5 and 2090s for SSP2-4.5, SSP3-7.0 and SSP5-8.5].



Fig. 15. Heating and cooling energy demands per average building type in the base scenario.

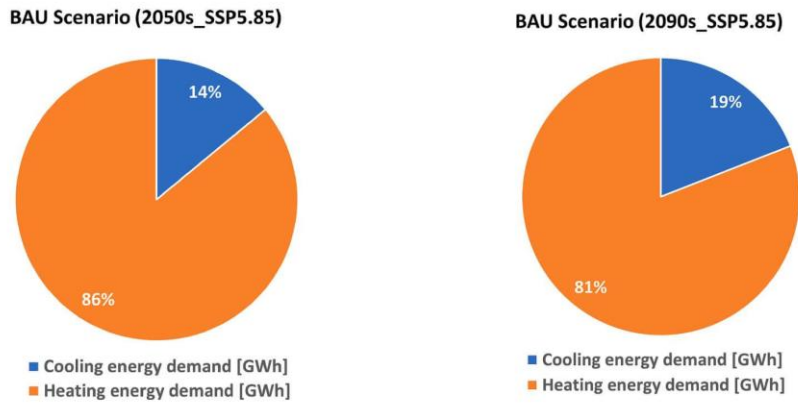

Fig. 16. Share of heating and cooling energy demands in the BAU scenario.

energy demand will decrease to 81%. This is also slightly different from the base scenario’s forecast, which predicts a proportion of 16% for heating and cooling energy demand, respectively.

The results of the BAU scenario for SSP5-8.5 reveal a significant increase in the demand for cooling in the building stock, while the heating energy demand decreases over time, as shown in Fig. 17. By the 2050s, the heating energy demand is expected to decrease by 12% compared to the base scenario in the 2010s, while the cooling energy demand is expected to increase by 109%. This trend continues into the 2090s, and the heating energy demand is projected to decrease by 21%, while the cooling energy demand is expected to increase by 170% compared to the base scenario in the 2010s.

The study also presents results on the building scale regarding the heating and cooling energy demand per average building. Fig. 18 compares the heating and cooling energy demand for an average building for different building types in the base scenario and BAU scenario in SSP5-8.5. The results indicate that in the BAU scenario, the cooling energy demand for an average building is expected to increase between 25% and 71% in the 2050s and by 77% and 154% in the 2090s compared to the base scenario in the 2010s. This decrease is attributed to the retrofit strategies applied to different building types. Moreover, the results show that in the BAU scenario, the heating energy demand for an average building is expected to decrease by 15% to 42% in the 2050s and by 24% to 48% in the 2090s compared to the base scenario in the 2010s.

3.2.3. Uncertainty analysis for renovation strategies

Additionally, uncertainty analysis for the renovation strategies is also assessed in this study. The analysis takes into consideration various scenarios, including slow, moderate, and fast renovation rates, and the results are used to determine the most likely outcome and the potential impact on the overall demand for heating and cooling. This information can be used to inform decision-makers and help them make informed decisions about energy-efficiency initiatives and policies. As explained in Table 2, scenario 1 is considered the reference scenario, and the other scenarios show the different renovation rates for the uncertain range of renovation strategies. The heating energy demand and cooling energy demand in the different renovation strategies for the whole building stock in the 2050s and 2090s are shown in Fig. 19 and Fig. 20, respectively.

The results of the renovation strategies for the 2090s are also shown in the figures above, where the change in heating and cooling energy demands compared to scenario 1 are listed. Notably, the change in demand by the 2090s follows the same trend as in the 2050s for the different renovation strategies, with changes in heating and cooling demands. Scenarios 2 and 3 both show an increase in cooling energy demand between 9% and 10%, while the heating energy demand increases by 27% and 25%, respectively. Similarly, scenarios 4 and 6 showed a slight increase in cooling energy demand (3% and 5%, respectively), while heating energy demand increases by 12% and 22%, respectively. Scenario 5 and scenario 7 show a 2% decrease in cooling energy demand, while heating energy demand decreases by 11%.

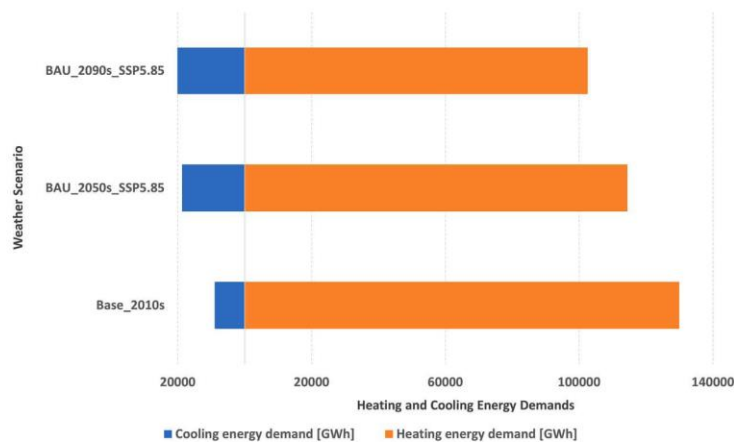

Fig. 17. Heating and cooling energy demands in the BAU scenario [Comparison between the 2010s, 2050s for SSP5-8.5 and 2090s for SSP5-8.5].

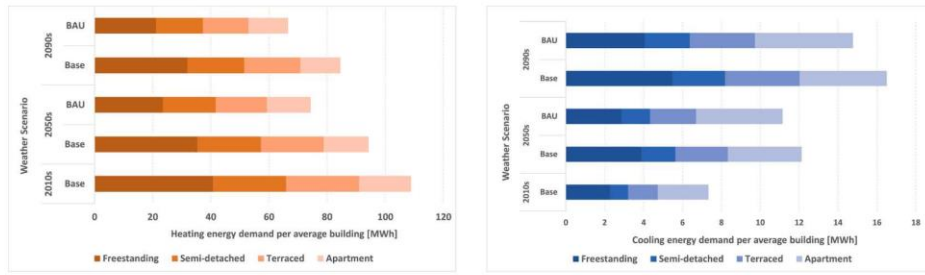

Fig. 18. Heating and cooling energy demands per an average building type [comparison between the Base and BAU scenarios].

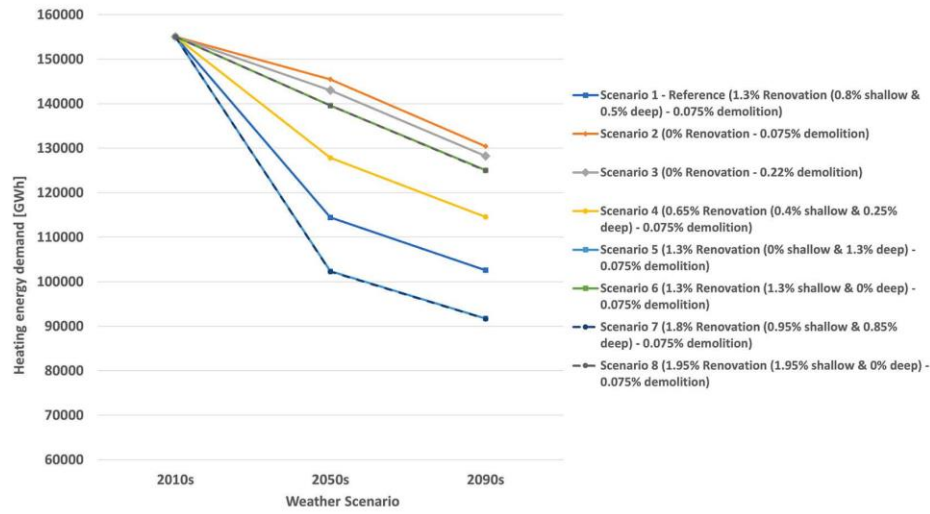

Fig. 19. Heating energy demand in the different renovation scenarios for the whole building stock.

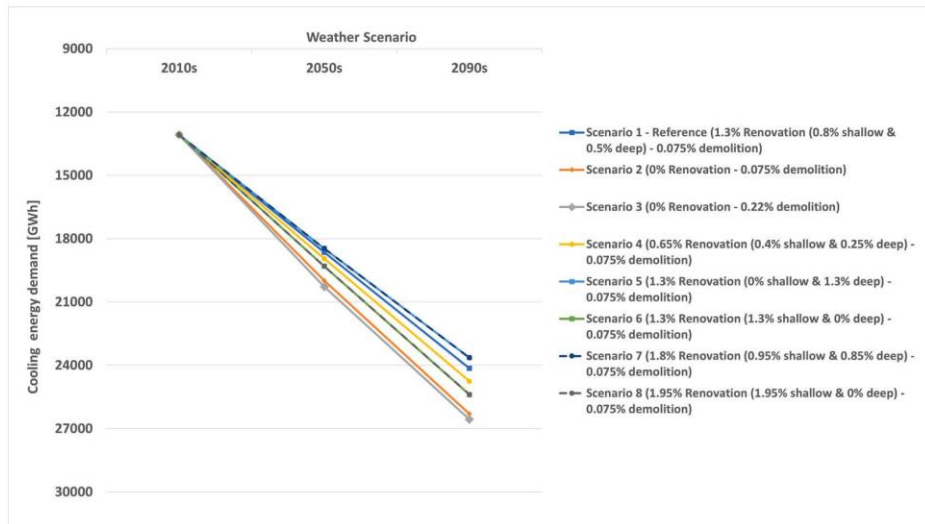

Fig. 20. Cooling energy demand in the different renovation scenarios for the whole building stock.

Finally, scenario 8 shows an increase in cooling energy demand by 5%, while heating energy demand increases by 22%.

Comparing the BAU base scenario with the BAU deep renovation and

shallow renovation strategies shows significant variations in heating and cooling energy demands, as shown in Fig. 21. Notably, the BAU base scenario has a 0.8% per year shallow renovation rate and a 0.5% per

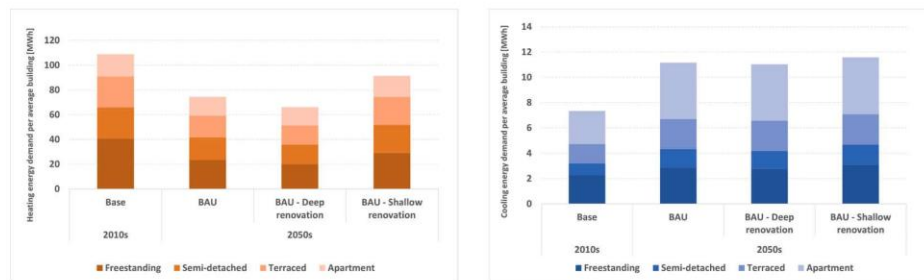

Fig. 21. Average heating and cooling energy demands in deep and shallow renovation scenarios.

year deep renovation rate, the deep renovation strategy characterized by the highest deep renovation rate of 1.3% per year (scenario 5). Conversely, the shallow renovation approach features the highest shallow renovation rate of 1.95% per year (scenario 8). These findings emphasize the influence of the renovation rate on the effectiveness of each strategy in achieving energy efficiency gains. In the BAU deep renovation scenario, all building types exhibit substantial reductions in heating energy demand. Freestanding buildings show a remarkable decrease of approximately 15%, indicating the efficacy of comprehensive retrofitting measures. Semi-detached and terraced buildings also benefit from notable reductions of around 12% and 11%, respectively. Apartments display a more moderate reduction of about 2%. In the BAU shallow renovation scenario, heating energy demand tends to increase in comparison to the BAU baseline. Freestanding, semi-detached, and terraced buildings experience rises of approximately 24%, 25%, and 28%, respectively. Apartments also show an increase of about 13%.

The BAU deep renovation demonstrates a positive impact on cooling energy demand, with freestanding and semi-detached buildings experiencing reductions of approximately 3% and 4%, respectively. In contrast, terraced buildings display a marginal increase of about 1%, while apartments show a minimal increase of around 0.1%. On the other side, the BAU shallow renovation strategy shows different patterns, leading to varying degrees of increase in cooling energy demand. Freestanding buildings demonstrate a noticeable rise of approximately 8%, while semi-detached buildings experience an increment of about 9%. Terraced buildings exhibit a modest increase of approximately 1%, and apartments show a small increase of around 0.72%.

4. Discussion

4.1. Findings and recommendations

The IPCC predicts that global temperatures will increase by 1.5 °C above pre-industrial levels by mid-century if greenhouse gas emissions are not rapidly reduced. If emissions continue to rise at their current rate, the global temperature could rise in the range of 1–5.7 °C by the end of the century, depending on the SSP scenario, with significant impacts on the environment, human health, and socio-economic systems. This study analysed the average monthly outdoor temperatures in Brussels using three different MAR simulations. The results showed that the temperature is expected to increase between 0.5 and 4.1 °C in the future compared to the 2010s, with the highest increase in the SSP5-8.5 scenarios.

This study considers three MAR simulations to analyse the impact of climate change on energy demand in Brussels. These simulations, namely MAR-BCC, MAR-MPI, and MAR-MIR, are based on different Earth System Models and are used to generate future climate scenarios for the 21st century. The MAR-ESM BCC-CSM2-MR, one of the 30 ESMs used in climate research, simulates warming that is close to the ensemble mean for the year 2100 using the SSP5-8.5 scenario. The SSP5-8.5 scenario represents a future where greenhouse gas emissions

continue to rise, leading to high levels of warming and significant climate change impacts. In contrast, the MAR-ESM MIROC6 simulates larger warming than the ensemble means for the same scenario and time horizon. This suggests that MIROC6 may be more sensitive to changes in greenhouse gas concentrations and feedback mechanisms than other models in the ensemble. The MIROC6 model's projections indicate that the impacts of climate change could be more severe than anticipated by the ensemble mean. On the other hand, the MAR-ESM MPI-ESM.1.2 simulates lower warming than the ensemble means by the year 2100. This indicates that the MPI-ESM.1.2 model may be less sensitive to changes in greenhouse gas concentrations and feedback mechanisms than the other models in the ensemble. This highlights the inherent uncertainty in climate modelling and the need for a range of models to provide a more comprehensive picture of potential future climate scenarios. Overall, the differences in the warming projections between these three ESMs illustrate the range of potential outcomes that could occur by the year 2100, highlighting the importance of continued research and action to mitigate the impacts of climate change.

The study assessed the shift in the demand for heating and cooling in the building stock over time. The changes in weather conditions are more conducive to modifications of cooling energy demand than heating energy demand. This shift in the demand for heating and cooling has significant implications for energy demand patterns and resource use, highlighting the need for effective policy interventions to promote sustainable energy use and mitigate the impact of climate change. The results of the base scenario indicate that the share of cooling energy demand over the total demand is anticipated to increase from 6% in the 2010s scenario to 12% in the 2050s and to 16% in the 2090s, while the share of the heating energy demand over total demand is expected to decrease from 94% in the 2010s scenario to 88% in the 2050s and 84% in the 2090s. The study also showed that heating energy demand is expected to decrease by 8% to 13% in the 2050s and 13% to 22% in the 2090s, while cooling energy demand is expected to increase by 39% to 65% in the 2050s and 61% to 123% in the 2090s, depending on the scenario.

Furthermore, the study found that, in the base scenario, without the implementation of any demolition or renovation strategies, the impact of climate change on energy demand varies depending on building types. The increase in the cooling energy demand for semi-detached houses and terraced houses is expected to be bigger than freestanding houses since they share common walls and are not properly insulated, which can increase heat transfer between the houses. Additionally, they have fewer walls exposed to the outside which can trap heat inside and hence require more cooling to maintain comfortable indoor temperatures. This means that if one house is cooled, it will also affect the temperature of the adjacent house, increasing the overall cooling energy demand. In contrast, freestanding houses do not share common walls, which means that they are less affected by heat transfer from neighbouring houses and have more space between the walls and the surrounding environment, allowing for more natural ventilation. Moreover, apartments tend to have shared walls and are often located in multi-

story buildings, which means they have less exposed surface area, which also helps to regulate temperatures and reduce the cooling energy demand. The insulation and characteristics of the buildings are key factors in determining their heating and cooling energy demands. Buildings with higher insulation and more efficient characteristics generally have lower demands compared to those with lower insulation and less efficient characteristics.

Additionally, in this study, the BAU scenario considers current trends in the country, with average demolition and construction rates of 0.075% and 0.9% per year, respectively and an average renovation rate of 1.3% per year. By the 2050s, the share of heating energy demand will decrease to 14%, while the share of cooling energy demand will increase to 86%. By the 2090s, the share of cooling energy demand is expected to reach 19%, while the share of heating energy demand will decrease to 81%. In the BAU scenario for SSP5-8.5, cooling energy demand is projected to increase by 109% in the 2050s and 170% in the 2090s, while heating energy demand is expected to decrease by 12% and 21% in the 2050s and the 2090s, respectively, compared to the base scenario in the 2010s. The total demand is expected to decrease by 4% in the 2050s and decrease by 9% in the 2090s compared to the base scenario in the 2010s.

Retrofit strategies applied to different building types in the BAU scenario contribute to lowering the increase in the cooling energy demand in the 2050s and the 2090s compared to the base scenario. The cooling energy demand in the BAU scenario is expected to increase with a range of 25% to 71% in the 2050s compared to 45% to 92% in the base scenario and 77% to 154% in the 2090s compared to 72% to 198% in the base scenario compared to the 2010s. In contrast, the heating energy demand for an average building is expected to decrease more substantially than in the base scenario, with a range of 15% to 42% in the 2050s and 24% to 48% in the 2090s compared to the base scenario in the 2010s.

Overall, the BAU scenario, with its retrofit strategies and climate change projections, demonstrates the complex and dynamic nature of the building stock and the importance of considering long-term planning and strategies to achieve sustainable energy use. The results of the renovation scenarios on a macroscopic scale for the whole building stock show that the increase or decrease in the renovation rates has a significant impact on the heating, cooling and total demand in buildings. As shown in Table 2, scenarios without renovation or when the renovation rate decreases lead to a slight increase in cooling energy demand and a moderate or significant increase in heating and total demand. This can be attributed to the fact that when buildings are not renovated, they have poor insulation and are unable to retain heat in cold weather, leading to an increase in heating energy demand. Conversely, in warm weather, buildings without proper insulation have difficulty keeping cool air inside, leading to an increase in cooling energy demand. On the other hand, when the renovation rate increases, the heating and total demands significantly decrease while the cooling energy demand slightly decreases or increases according to the indoor and outdoor conditions and the building type and characteristics. This is due to the fact that an increase in renovation and insulation of the buildings helps to reduce heat loss during cold weather and keep the building cooler during warm weather. However, in cases where the indoor temperature is higher than the outdoor temperature, such as during hot summer days, the increase in renovation and insulation of the buildings can lead to an increase in the cooling loads due to the trapped heat inside the building. In highly-insulated buildings, the exchange of heat between the indoor and outdoor environments will be reduced. This can result in the accumulation of heat generated from various sources inside the building, such as appliances, lighting, and human activity [78,79].

On a microscopic level, it is noteworthy that apartment buildings have the highest increase in cooling energy demand compared to other building types due to their high insulation, which makes it more difficult to extract the solar gains and the internal gains out of the building. In contrast, after applying renovation to the building stock in the BAU scenario, freestanding houses have the lowest increase in cooling energy

demand and the highest decrease in heating energy demand.

Additionally, the comprehensive retrofitting measures of the deep renovation scenario outperform the more modest changes in the shallow renovation strategy, leading to notably higher energy efficiency gains. These findings underscore the significance of prioritizing comprehensive retrofitting approaches to effectively address heating and cooling energy demands and contribute to sustainable energy consumption practices.

When comparing these results with studies conducted in different countries, it becomes evident that variations exist across different climate regions. For instance, studies conducted in the United States, Brazil, and Mediterranean climate regions indicate a higher decrease in heating energy demand compared to Belgium, suggesting potential differences in climate sensitivity and energy efficiency measures. In contrast, studies conducted in Canada and the United States show a similar average increase in cooling demand as observed in Belgium, implying shared challenges in addressing rising temperatures. Notably, a study conducted in Switzerland stands out, revealing a much more significant increase in cooling demand compared to Belgium. Lastly, another study has been conducted in Belgium by Elnagar et al. [80] aligns with the aforementioned trends, reporting similar results for a multi-zone apartment building. The study found that by the end of the century, there was a projected increase in cooling energy end-use by 187% and a decrease in heating energy end-use by 40%.

The list below is given as a summary of the main findings and recommendations.

- It is recommended to use different climate models and four different SSP scenarios to provide a range of future climate scenarios.
- The results showed that the increase in cooling energy demand is expected to be higher than the decrease in heating energy demand due to climate change.
- It is also recommended to assess various renovation strategies for the building stock, as the study found that the insulation and characteristics of the buildings are key factors in determining their heating and cooling energy demands.
- The study highlights the importance of effective policy interventions to promote sustainable energy use and mitigate the impact of climate change.

4.2. Strengths and limitations

This study provides a framework to assess climate change impact on heating and cooling energy demands in residential building stock by 2050 and 2100 with a case study applied to Belgium. This section emphasizes the strength and limitations that were encountered in the study.

The first strength of the paper relies on the use of the multi-zone dynamic approach, which allows for a more accurate and detailed description of each building in the building stock, including the accurate calculation of indoor conditions and heating and cooling energy demands [81,82]. This level of detail is important for accurately assessing energy use and potential savings in the building stock and can help inform policy decisions and building retrofit strategies. Another strength of the paper is that it provides a framework for calculating the heating and cooling energy demands in the future under different climate change scenarios. This approach allows for both microscopic and macroscopic results for individual buildings and the building stock as a whole. This allows for the identification of specific buildings that may require more attention or intervention based on their unique characteristics and heating and cooling energy demands. It also provides a more comprehensive view of the entire building stock and how it may be impacted by climate change, allowing for more informed decision-making and policy development. The third strength of the paper is related to the accuracy and reliability of the weather data used in the simulations. The study used the MAR model, which is known for its high spatial resolution of approximately 5 km since it allows for more

accurate and detailed modelling of weather patterns and their impacts, such as the effects of climate change on building design and energy management systems [83]. Additionally, having high-resolution data can help bridge the gap between regional and global climate models, which often have significant differences in their predictions. This model also takes into account mesoscale phenomena, which are atmospheric processes that occur at regional scales (i.e. urban heat island), and it has been specifically tuned for the studied region of Belgium. As a result, the weather data used in this study is considered to be highly valid and representative of the climate in Belgium. Finally, the paper also demonstrates a significant strength by evaluating the effects of various renovation strategies on the heating and cooling energy demands of the building stock. This approach assists in identifying the degree of uncertainty related to the renovation rates and their effects on the energy demand of the building stock. By using different renovation scenarios, the research provides a broader understanding of the potential strategies that could be used to enhance the energy efficiency of the building stock.

However, the study has some limitations. First, the limited number of representative building types may not be sufficient to characterize the diversity of the building stock in different regions of Belgium, which highlights the need for more detailed and comprehensive data on the Belgian building stock to improve the accuracy and reliability of the findings. The second limitation of the study is related to not taking into account the active air conditioning system in the residential building stock. As in temperate climate regions like Belgium, the use of active air conditioning systems in residential buildings is not very common or necessary in the past years. The third limitation is the premise that the weather data for the entire building stock is representative of the Brussels weather pattern, as it assumes that it represents the average weather of Belgium. This assumption may be subject to limitations since the weather patterns may exhibit slight variations from one city to another. Lastly, it is acknowledged that this study utilizes ISO 13790:2007, which utilizes the 5R1C method, which has been replaced by ISO 52016-1. The new ISO standard introduces a more detailed and comprehensive model with several resistances and capacitances for each building element. However, it is worth noting that our research on the building stock modelling was initiated before the introduction of the new ISO standard, and this study built upon ISO 13790:2007 model to calculate the heating and cooling demands for buildings.

4.3. Implication on Practice and future research

The findings of this study have significant implications for both practice and future research. The study highlights the importance of taking several actions to mitigate the impacts of climate change, including retrofit strategies and the use of energy-efficient HVAC systems. Therefore, there is a need for effective policy interventions to promote sustainable energy use and mitigate the impact of climate change on the mandatory energy performance standards for residential buildings, which would require all new buildings to meet minimum energy efficiency standards. It could also apply to existing buildings during major renovations or refurbishments.

The study primarily focuses on the impact of climate change on future heating and cooling demands in buildings. Furthermore, it is important to note that another study utilizing a similar framework proposed by Elnagar et al. [41] specifically focused on the impact of climate change on future heating energy consumption using electric and gas heat pumps. This complementary study enhances our understanding of the implications of climate change on energy consumption and reinforces the importance of considering various energy carriers and sources in future energy scenarios. Additionally, this study is part of an ongoing project that aims to comprehensively analyse the impact of climate change on building energy demands. In the next phase, the research will explore different mitigation strategies, including the assessment of cooling energy consumption and the potential of active and passive cooling systems. By studying both heating and cooling

demands, a comprehensive understanding of the future energy requirements can be achieved, facilitating the identification of effective strategies for energy-efficient building design and operation in the face of climate change.

The study shows that the impact of climate change on energy demand varies depending on building types, highlighting the importance of considering building characteristics in energy demand and policy interventions. Buildings with higher insulation and more efficient characteristics, such as energy-efficient HVAC systems and the use of sustainable building materials, generally have lower heating and cooling energy demands compared to those with lower insulation and less efficient characteristics. Thus, policymakers should focus on promoting sustainable building practices and retrofitting existing buildings to be more energy-efficient through the introduction of subsidies or tax incentives to encourage homeowners to retrofit their properties to make them more energy-efficient. Moreover, the study highlights the inherent uncertainty in climate modelling and the need for a range of models to provide a more comprehensive picture of potential future climate scenarios. Future research should continue to focus on improving climate models to reduce uncertainty and provide more accurate predictions [84,85]. Additionally, there is a need for more research on the impact of climate change on energy demand in different regions and building types to inform effective policy interventions. Finally, the following future research ideas are recommended. First, to develop decision-making frameworks and tools that account for uncertainties related to climate change, energy consumption, and GHG emissions and provide guidance to policymakers and building owners on the selection of appropriate air conditioning systems and adaptation strategies. Second, future research to assess the impact of climate change on thermal comfort in the different building types is also recommended. Third, future research is needed to conduct a comparative analysis of the performance of different air-conditioning systems in different climate zones, considering both energy efficiency and GHG emissions.

5. Conclusion

Climate change has drawn great attention in recent years because of its large impact on many aspects of building energy use. The methodology adopted in this study involved using future climate data to assess the heating and cooling energy demands in the Belgian building stock by 2050 and 2100. A dynamic building simulation model was used to focus on the future evolution in base and BAU scenarios. The findings revealed a projected decrease in heating energy demand in the base scenario, ranging from 8% to 13% in the 2050s and 13% to 22% in the 2090s. The study also found that the various retrofit strategies in the BAU scenario contribute to lessening the increase in cooling energy demand in the BAU scenario compared to the base scenario. The cooling energy demand in the BAU scenario is expected to increase with a range of 25% to 71% in the 2050s compared to 45% to 92% in the base scenario and 77% to 154% in the 2090s compared to 72% to 198% in the base scenario compared to the 2010s. The findings emphasize the need for proactive measures and effective strategies to mitigate the energy requirements for cooling in future scenarios.

Declaration of Competing Interest

The authors declare that they have no known competing financial interests or personal relationships that could have appeared to influence the work reported in this paper.

Data availability

Data will be made available on request.

Acknowledgement

This research was partially funded by the Walloon Region under the call 'Actions de Recherche Concertées 2019 (ARC)' (funding number: ARC 19/23-05) and the project OCCuPANt, on the Impacts Of Climate Change on the indoor environmental and energy PerformAnce of buildiNgs in Belgium during summer. The authors would like to gratefully acknowledge the Walloon Region and Liege University for funding. Computational resources have been provided by the Consortium des Équipements de Calcul Intensif (CÉCI), funded by the Fonds de la Recherche Scientifique de Belgique (F.R.S.-FNRS) under Grant No. 2.5020.11 and by the Walloon Region.

Appendix A

Table A1 summarizes the average coefficients of heat transmission (U-values) for the different building types and the different years of construction according to the insulation level. The source for the insulation values is according to, Tabula (value before renovation), LEHR (added insulation thickness for renovated elements of houses constructed before 1990), and EPB 2010 (for renovated elements of houses constructed after 1990) [33,46,86].

Table A2 summarizes the average elements of total thermal capacity (K-values) for the different building types and the different years of

Table A1
Average U-values for the different types of buildings and different years of construction.

Insulation	U _{wall} [W/m ² K]		U _{windows} [W/m ² K]		U _{roof} [W/m ² K]		U _{floor} [W/m ² K]		U _{door} [W/m ² K]	
	NI ¹	WI ²	NI	WI	NI	WI	NI	WI	Mean	
Year of construction	<1945	2.25	0.59	5	2.75	4.15	0.44	3.38	0.77	3.3
	1946–1970	1.56	0.53	5	2.75	3.33	0.43	3.38	0.77	3.3
	1971–1990	0.98	0.44	3.5	2.75	0.77	0.3	1.14	0.43	3.3
	1991–2007	0.49	0.4	3.5	2	0.43	0.3	0.73	0.4	3.3
	>2008	0.4		2		0.3		0.4		3.3

¹Not Insulated.

²With Insulation.

Table A2
Average K-values for the different types of buildings and different years of construction.

Insulation	K _{wall} [kJ/m ² K]		K _{roof} [kJ/m ² K]		K _{floor} [kJ/m ² K]		
	NI	WI	NI	WI	NI	WI	
Year of construction	<1945	453.6	472.1	30.9	43.8	235.2	236.4
	1946–1970	483.9	502.4	42.6	55.5	235.2	236.4
	1971–1990	349.2	412.7	44.7	57.5	347.5	348.7
	1991–2007	396.2	414.8	46.7	50.9	348.1	349.2
	>2008	397.3		50.3		0.3	

Table A3
Infiltration rate at 50 Pa per type of building and year of construction.

Infiltration rate at 50 Pa [m ³ /hm ²]		Initial walls				Insulated walls after retrofit
Building type	Year of construction	Freestanding	Semi-detached	Terraced	Apartment	All types
		<1945	18	18	14.9	14.9
1946–1970	17.1	16.3	14.1	14.1	6	
1971–2007	12	12	10	10	6	
2008–2012	6.1	6.3	6	6	6	
>2012	2.5					

construction according to the insulation level. The source for the insulation values is according to, Tabula (wall composition) and LEHR (added insulation thickness for renovated elements of houses constructed before 1990) [33,86].

Table A3 summarizes the infiltration rates at 50 Pa in m³/hm² for different building types based on construction years, including values for walls that have undergone external insulation retrofits, as provided by TABULA [33] and EPB 2010 [46].

Appendix B

Table B1 provides average heating production systems efficiencies, expressed based on lower heating values (LHV) for both centralized heating systems and decentralized heating systems. The table provides the efficiency for space heating (SH) and domestic hot water (DHW) based on the type of energy vector used in both and the construction year of the building.

Fig. B1 shows the heating schedules approach for the building zones. Set points are imposed to fixed values; (W = 21 °C, A = 20 °C, X = 16 °C, and B = 10 °C), whereas the starting times and durations are obtained based on Gaussian probabilities characterized by averages and standard deviations.

Table B1
Heating production systems efficiency based on the lower heating values (LHV).

	Construction year	Energy vector SH	Energy vector DHW	Efficiency SH [-]	Efficiency DHW [-]
Centralized heating systems	< 2007	Gas	Gas	0.85	0.85
		Fuel	Fuel	0.8	0.8
		Gas	Electricity	0.85	1
		Fuel	Electricity	0.8	1
		Other	Other	0.8	0.8
	> 2007	Gas	Gas	1	1
		Fuel	Fuel	0.97	0.97
		Gas	Electricity	1	1
		Fuel	Electricity	0.97	1
		Other	Other	0.97	0.97
Decentralized heating systems	/	Electricity	Electricity	1	0.9
		Other	Other	1	1

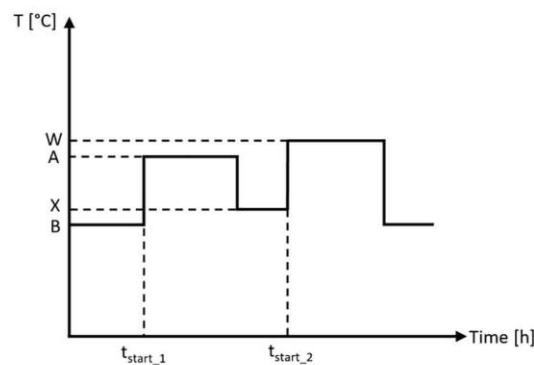

Fig. B1. Heating Schedules - statistical model parameters.

References

- [1] Climate Change 2021: The Physical Science Basis. Contribution of Working Group I to the Sixth Assessment Report of the Intergovernmental Panel on Climate Change. Cambridge University Press, 2021.
- [2] V. Eyring, S. Bony, G.A. Meehl, C.A. Senior, B. Stevens, R.J. Stouffer, K.E. Taylor, Overview of the Coupled Model Intercomparison Project Phase 6 (CMIP6) experimental design and organization, *Geosci. Model Dev.* 9 (5) (2016) 1937–1958.
- [3] E. Elnagar, A. Zeoli, R. Rahif, S. Attia, V. Lemort, A qualitative assessment of integrated active cooling systems: A review with a focus on system flexibility and climate resilience, *Renew. Sustain. Energy Rev.* 175 (2023), 113179, <https://doi.org/10.1016/j.rser.2023.113179>.
- [4] K. Ruosteenoja, P. Räisänen, Seasonal Changes in Solar Radiation and Relative Humidity in Europe in Response to Global Warming, *J. Clim.* 26 (2013) 2467–2481, <https://doi.org/10.1175/JCLI-D-12-00007.1>.
- [5] T.R. Karl, J.M. Melillo, T.C. Peterson, Global climate change impacts in the United States, Cambridge University Press, 2009.
- [6] C. Wyard, S. Doutreloup, A. Belleflamme, M. Wild, X. Fettweis, Global Radiative Flux and Cloudiness Variability for the Period 1959–2010 in Belgium: A Comparison between Reanalyses and the Regional Climate Model MAR, *Atmos.* 9 (2018) 262, <https://doi.org/10.3390/atmos9070262>.
- [7] N. Nakicenovic, J. Alcamo, G. Davis, B. de Vries, J. Fenhann, S. Gaffin, et al., Special Report on Emissions Scenarios. A Special Report of Working Group III of the Intergovernmental Panel on Climate Change, Cambridge University Press, Cambridge, UK and New York, NY, USA, 2000.
- [8] K. Riahi, D.P. van Vuuren, E. Kriegler, J. Edmonds, B.C. O'Neill, S. Fujimori, N. Bauer, K. Calvin, R. Dellink, O. Fricko, W. Lutz, A. Popp, J.C. Cuaresma, S. Ke, M. Leimbach, L. Jiang, T. Kram, S. Rao, J. Emmerling, K. Ebi, T. Hasegawa, P. Havlik, F. Humpenöder, L.A. Da Silva, S. Smith, E. Stehfest, V. Bosetti, J. Eom, D. Gernaat, T. Masui, J. Rogelj, J. Streffer, L. Drouet, V. Krey, G. Luderer, M. Harmsen, K. Takahashi, L. Baumstark, J.C. Doelman, M. Kainuma, Z. Klimont, G. Marangoni, H. Lotze-Campen, M. Obersteiner, A. Tabeau, M. Tavoni, The Shared Socioeconomic Pathways and their energy, land use, and greenhouse gas emissions implications: An overview, *Glob. Environ. Chang.* 42 (2017) 153–168.
- [9] al J, Paasche Ø. IPCC [Intergovernmental Panel on Climate Change]. Climate Change 2007: The Physical Science Basis. Contribution of Working Group I to the Fourth Assessment Report of the IPCC. Cambridge, United Kingdom Cambridge University Press. vol. 499–587, 2007, p. 434–97.
- [10] D. Ürges-Vorsatz, L.F. Cabeza, S. Serrano, C. Barreneche, K. Petrichenko, Heating and cooling energy trends and drivers in buildings, *Renew. Sustain. Energy Rev.* 41 (2015) 85–98, <https://doi.org/10.1016/j.rser.2014.08.039>.
- [11] H. Wang, Q. Chen, Impact of climate change heating and cooling energy use in buildings in the United States, *Energy Buildings* 82 (2014) 428–436, <https://doi.org/10.1016/j.enbuild.2014.07.034>.
- [12] T.h. Frank, Climate change impacts on building heating and cooling energy demand in Switzerland, *Energy Buildings* 37 (2005) 1175–1185, <https://doi.org/10.1016/j.enbuild.2005.06.019>.
- [13] V. Pérez-Andreu, C. Aparicio-Fernández, A. Martínez-Iberón, J.-L. Vivanco, Impact of climate change on heating and cooling energy demand in a residential building in a Mediterranean climate, *Energy* 165 (2018) 63–74, <https://doi.org/10.1016/j.energy.2018.09.015>.
- [14] U. Berardi, P. Jafarpur, Assessing the impact of climate change on building heating and cooling energy demand in Canada, *Renew. Sustain. Energy Rev.* 121 (2020), 109681, <https://doi.org/10.1016/j.rser.2019.109681>.
- [15] A. Invidiata, E. Ghisi, Impact of climate change on heating and cooling energy demand in houses in Brazil, *Energy Buildings* 130 (2016) 20–32, <https://doi.org/10.1016/j.enbuild.2016.07.067>.
- [16] V.M. Nik, K.A. Sasic, Impact study of the climate change on the energy performance of the building stock in Stockholm considering four climate uncertainties, *Build. Environ.* 60 (2013) 291–304, <https://doi.org/10.1016/j.buildenv.2012.11.005>.
- [17] S. Attia, C. Gobin, Climate Change Effects on Belgian Households: A Case Study of a Nearly Zero Energy Building, *Energies* 13 (2020) 5357, <https://doi.org/10.3390/en13205357>.
- [18] S. Doutreloup, X. Fettweis, R. Rahif, E. Elnagar, M.S. Pourkiaei, D. Amaripadath, S. Attia, Historical and future weather data for dynamic building simulations in Belgium using the regional climate model MAR: typical and extreme meteorological year and heatwaves, *Earth Syst. Sci. Data* 14 (7) (2022) 3039–3051, <https://doi.org/10.5278/1JSEPM.2014.4.7>.
- [19] S. Gendebien, E. Georges, S. Bertagnolio, V. Lemort, Methodology to characterize a residential building stock using a bottom-up approach: a case study applied to Belgium, *Int. J. Sustain. Energy Plann. Manage.* (2015): 71, <https://doi.org/10.5278/1JSEPM.2014.4.7>.
- [20] A. Mastrucci, A. Marvuglia, U. Leopold, E. Benetto, Life Cycle Assessment of building stocks from urban to transnational scales: A review, *Renew. Sustain. Energy Rev.* 74 (2017) 316–332, <https://doi.org/10.1016/j.rser.2017.02.060>.
- [21] M. Kavgić, A. Mavrogianni, D. Mumovic, A. Summerfield, Z. Stevanovic, M. Djurovic-Petrovic, A review of bottom-up building stock models for energy consumption in the residential sector, *Build. Environ.* 45 (2010) 1683–1697, <https://doi.org/10.1016/j.buildenv.2010.01.021>.
- [22] S. Reiter, A.-F. Marique, Toward Low Energy Cities: A Case Study of the Urban Area of Liège, Belgium, *J. Ind. Ecol.* 16 (2012) 829–838, <https://doi.org/10.1111/j.1530-9290.2012.00533.x>.

- [23] L. Shorrock, J. Dunster, The physically-based model BREHOMES and its use in deriving scenarios for the energy use and carbon dioxide emissions of the UK housing stock, *Energy Policy* 25 (1997) 1027–1037, [https://doi.org/10.1016/S0301-4215\(97\)00130-4](https://doi.org/10.1016/S0301-4215(97)00130-4).
- [24] E. Verellen, K. Allacker, Developing a Building Stock Model to Enable Clustered Renovation—The City of Leuven as Case Study, *Sustainability* 14 (2022) 5769, <https://doi.org/10.3390/su14105769>.
- [25] Y.J. Huang, J. Brodrick, A bottom-up engineering estimate of the aggregate heating and cooling loads of the entire U.S. building stock (2000).
- [26] J. Langevin, J.L. Reyna, S. Ebrahimigharehbaghi, N. Sandberg, P. Fennell, C. Nägeli, J. Laverge, M. Delghust, É. Mata, M. Van Hove, J. Webster, F. Federico, M. Jakob, C. Camarasa, Developing a common approach for classifying building stock energy models, *Renew. Sustain. Energy Rev.* 133 (2020) 110276.
- [27] R. Ghedamsi, N. Settou, A. Gouareh, A. Khamouli, N. Saifi, B. Reclouli, B. Dokkar, Modeling and forecasting energy consumption for residential buildings in Algeria using bottom-up approach, *Energy. Buildings* 121 (2016) 309–317.
- [28] A.M.R. Nishimwe, S. Reiter, Building heat consumption and heat demand assessment, characterization, and mapping on a regional scale: A case study of the Walloon building stock in Belgium, *Renew. Sustain. Energy Rev.* 135 (2021), 110170, <https://doi.org/10.1016/j.rser.2020.110170>.
- [29] Reynders G, Diriken J, Saelens D. Bottom-up modeling of the Belgian residential building stock: influence of model complexity. Proceedings of the 9th International Conference on System Simulation in Buildings - SSB2014, 2014.
- [30] Georges E, Gendebien S, Dechesne B, Bertagnolio S, Lemort V. Impact of the integration of various heating technologies on the energy load profiles of the Belgian residential building stock. Proceedings of IRES 2013 conference, 2013.
- [31] Georges E, Gendebien S, Bertagnolio S, Lemort V. Modeling and simulation of the domestic energy use in Belgium following a bottom-up approach. Proceedings of the CLIMA 2013 11th REHVA World Congress & 8th International Conference on IAQVEC, 2013.
- [32] Protapapadaki C, Reynders G, Saelens D. Bottom-up modelling of the Belgian residential building stock: impact of building stock descriptions. Proceedings of the 9th International Conference on System Simulation in Buildings-SSB2014, Belgium; 2014.
- [33] Cyx W, Renders N, Van Holm M, Verbeke S. IEE TABULA-typology approach for building stock energy assessment. Mol, Belgium 2011.
- [34] Vanneste D, Thomas I, Goossens L. Enquête socio-économique 2001 - Monographie «Le logement en Belgique». SPF Economie, Direction générale Statistique et Information Economique (DGSIE), Politique scientifique fédérale; 2007.
- [35] H. Hens, G. Verbeeck, B. Verdonck, Impact of energy efficiency measures on the CO₂ emissions in the residential sector, a large scale analysis, *Energy. Buildings* 33 (2001) 275–281, [https://doi.org/10.1016/S0378-7788\(00\)00092-X](https://doi.org/10.1016/S0378-7788(00)00092-X).
- [36] Gendebien S. Economic and environmental impacts of several retrofit options for residential buildings 2011.
- [37] Allacker K. Sustainable Building: The Development of an Evaluation Method (Duurzaam bouwen: ontwikkeling van een evaluatiemethode op gebouwniveau). 2010.
- [38] K. Allacker, F. De Troyer, D. Trigaux, T. Geerken, C. Spirinckx, W. Debacker, et al., Sustainability, Financial and Quality evaluation of Dwelling Types - SuFiQuAD - FINAL REPORT, Belgian Science Policy Belspo, Brussels, 2011.
- [39] EUROSTAT. Statistics Belgium. EUROPEAN STATISTICAL RECOVERY DASHBOARD 2011. <https://statbel.fgov.be/en>.
- [40] Kints C. La rénovation énergétique et durable des logements Wallons. Analyse du bâti existant et mise en évidence de typologies de logements prioritaires. Architecture & Climat, Louvain-La-Neuve: 2008.
- [41] Elnagar E, Davila C, Lemort V. Impact of integration of electric and gas heat pumps on the final energy consumption of Belgian residential building stock. CLIMA 2022 conference, 2022. <https://doi.org/10.34641/clima.2022.102>.
- [42] Van Hecke E, Jean-Marie H, Decroly J-M, Mérenne-Schoumaker B. Noyaux d'habitat et Régions urbaines dans une Belgique urbanisée 2009.
- [43] Department of Energy and Sustainable Buildings - Office for Sustainable Buildings. WALLOON LONG-TERM BUILDING RENOVATION STRATEGY. 2021.
- [44] Boermans T, Bettgenhäuser K, Offermann M, Schimschar S. Renovation tracks for Europe up to 2050. 2012.
- [45] R. Verhoeven, Pathways to World-Class energy efficiency in Belgium, McKinsey & Company-2009, Belgium, 2009.
- [46] European Union. Directive 2010/31/EU of the European Parliament and of the Council of 19 May 2010 on the energy performance of buildings. 2010.
- [47] Ibsa Perspective.brussels. Indicators - Neighborhood Monitoring n.d. <https://monitoringdesquartiers.brussels/indicateurs> (accessed July 7, 2023).
- [48] S. Doutreloup, C. Wyard, C. Amory, C. Kittel, M. Ercicum, X. Fettweis, Sensitivity to Convective Schemes on Precipitation Simulated by the Regional Climate Model MAR over Belgium (1987–2017), *Atmos.* 10 (2019) 34, <https://doi.org/10.3390/atmos10010034>.
- [49] C. Wyard, C. Scholzen, S. Doutreloup, É. Hallot, X. Fettweis, Future evolution of the hydroclimatic conditions favouring floods in the south-east of Belgium by 2100 using a regional climate model, *Int. J. Climatol.* 41 (2021) 647–662, <https://doi.org/10.1002/joc.6642>.
- [50] Fettweis X, Wyard C, Doutreloup S, Belleflamme A. Noël 2010 en Belgique : neige en Flandre et pluie en Haute-Ardenne. <https://popups.uliege.be/0770-7576.n.d>. <https://popups.uliege.be/0770-7576/index.php?id=4568&format=print> (accessed January 20, 2022).
- [51] Doutreloup S, Bois B, Pohl B, Zito S, Richard Y. Climatic comparison between Belgium, Champagne, Alsace, Jura and Bourgogne for wine production using the regional model MAR. *OENO One* 2022;56:1–17. <https://doi.org/10.20870/oeno-one.2022.56.3.5356>.
- [52] H. Hersbach, B. Bell, P. Berrisford, S. Hirahara, A. Horányi, J. Muñoz-Sabater, J. Nicolas, C. Peubey, R. Radu, D. Schepers, A. Simmons, C. Soci, S. Abdalla, X. Abellan, G. Balsamo, P. Bechtold, G. Biavati, J. Bidlot, M. Bonavita, G. De Chiara, P. Dahlgren, D. Dee, M. Diamantakis, R. Dragani, J. Flemming, R. Forbes, M. Fuentes, A. Geer, L. Haimberger, S. Healy, R.J. Hogan, E. Hölm, M. Janisková, S. Keeley, P. Lalouaux, P. Lopez, C. Lupu, G. Radnoti, P. de Rosnay, I. Rozum, F. Vamborg, S. Villaume, J.-N. Thépaut, The ERA5 global reanalysis, *QJR Meteorol. Soc* 146 (730) (2020) 1999–2049.
- [53] T. Wu, R. Yu, Y. Lu, W. Jie, Y. Fang, J. Zhang, et al., BCC-CSM2-HR: A High-Resolution Version of the Beijing Climate Center Climate System Model, *Clim. Earth Syst. Model.* (2020), <https://doi.org/10.5194/gmd-2020-284>.
- [54] O. Gutjahr, D. Putrasahan, K. Lohmann, J.H. Jungclaus, J.-S. von Storch, N. Brüggemann, H. Haak, A. Stössel, Max Planck Institute Earth System Model (MPI-ESM1.2) for the High-Resolution Model Intercomparison Project (HighResMIP), *Geosci. Model Dev.* 12 (7) (2019) 3241–3281.
- [55] H. Tatebe, T. Ogura, T. Nitta, Y. Komuro, K. Ogochi, T. Takemura, K. Sudo, M. Sekiguchi, M. Abe, F. Saito, M. Chikira, S. Watanabe, M. Mori, N. Hirota, Y. Kawatani, T. Mochizuki, K. Yoshimura, K. Takata, R. Oishi, D. Yamazaki, T. Suzuki, M. Kurogi, T. Kataoka, M. Watanabe, M. Kimoto, Description and basic evaluation of simulated mean state, internal variability, and climate sensitivity in MIROC6, *Geosci. Model Dev.* 12 (7) (2019) 2727–2765.
- [56] Elnagar E, Doutreloup S, Lemort V. Modeling the impact of Climate Change on Future Heating Demand in Different Types of Buildings in the Belgian residential building stock, 2021. <https://doi.org/10.26868/25222708.2021.30851>.
- [57] V. Eyring, N.P. Gillett, K. Achutarao, R. Barimalala, M. Barreiro Parrillo, N. Bellouin, et al., Human Influence on the Climate System. Climate Change 2021: the Physical Science Basis. Contribution of Working Group I to the Sixth Assessment Report of the Intergovernmental Panel on Climate Change, Cambridge University Press, 2021.
- [58] Wilcox S, Marion W. Users Manual for TMY3 Data Sets. National Renewable Energy Lab. (NREL), Golden, CO (United States); 2008. <https://doi.org/10.2172/928611>.
- [59] C.S. Barnaby, U.B. Crawley, Weather data for building performance simulation, Routledge, Building Performance Simulation for Design and Operation, 2011.
- [60] J.M. Finkelstein, R.E. Schafer, Improved goodness-of-fit tests, *Biometrika* 58 (1971) 641–645, <https://doi.org/10.1093/biomet/58.3.641>.
- [61] D. Ramon, K. Allacker, N.P.M. van Lipzig, F. De Troyer, H. Wouters, Future Weather Data for Dynamic Building Energy Simulations: Overview of Available Data and Presentation of Newly Derived Data for Belgium, in: E. Motaasca, A. K. Agarwal, H. Breesch (Eds.), Energy Sustainability in Built and Urban Environments, Springer Singapore, Singapore, 2019, pp. 111–138, https://doi.org/10.1007/978-981-13-3284-5_6.
- [62] International Organization for Standardization. European Standard: ISO 15927-4 Hygrothermal performance of buildings — calculation and presentation of climatic data — Part 4: Hourly data for assessing the annual energy use for heating and cooling. 2005.
- [63] Ashrae handbook: Fundamentals. Atlanta: Ashrae; 2013.
- [64] International Organization for Standardization. EN ISO 13790:2008 - Energy performance of buildings. Calculation of energy use for space heating and cooling: BSI British Standards; n.d. <https://doi.org/10.3403/30133624>.
- [65] R. Bruno, G. Pizzuti, N. Arcuri, The Prediction of Thermal Loads in Building by Means of the EN ISO 13790 Dynamic Model: A Comparison with TRNSYS, *Energy Procedia* 101 (2016) 192–199, <https://doi.org/10.1016/j.egypro.2016.11.025>.
- [66] P. Michalak, The simple hourly method of EN ISO 13790 standard in Matlab/Simulink: A comparative study for the climatic conditions of Poland, *Energy* 75 (2014) 568–578.
- [67] J. Vivian, A. Zarella, G. Emmi, M. De Carli, An evaluation of the suitability of lumped-capacitance models in calculating energy needs and thermal behaviour of buildings, *Energy. Buildings* 150 (2017) 447–465, <https://doi.org/10.1016/j.enbuild.2017.06.021>.
- [68] Ballarini I, Costantino A, Fabrizio E, Corrado V. The Dynamic Model of EN ISO 52016-1 for the Energy Assessment of Buildings Compared to Simplified and Detailed Simulation Methods, Rome, Italy: n.d., p. 3847–54. <https://doi.org/10.26868/25222708.2019.210431>.
- [69] van Dijk D. EN ISO 52016 1: The new International Standard to calculate building energy needs for heating and cooling, internal temperature and heating and cooling loads. Proceedings of the Building Simulation, 2019.
- [70] Y. Li, Z. O'Neill, L. Zhang, J. Chen, P. Im, J. DeGraw, Grey-box modeling and application for building energy simulations - A critical review, *Renew. Sustain. Energy Rev.* 146 (2021), 111174, <https://doi.org/10.1016/j.rser.2021.111174>.
- [71] D. Jenkins, Y. Liu, A.D. Peacock, Climatic and internal factors affecting future UK office heating and cooling energy consumptions, *Energy and Buildings* 40 (2008) 874–881, <https://doi.org/10.1016/j.enbuild.2007.06.006>.
- [72] D.P. Jenkins, The importance of office internal heat gains in reducing cooling loads in a changing climate, *International Journal of Low-Carbon Technologies* 4 (2009) 134–140, <https://doi.org/10.1093/ijlct/ctp019>.
- [73] Statistics Belgium. 2011 census - Average size of private households n.d. https://www.census2011.be/data/fresult/householdsize_fr.html (accessed February 15, 2023).
- [74] International Standard Organization. ISO 17772-1:2017 Energy performance of buildings — Indoor environmental quality — Part 1: Indoor environmental input parameters for the design and assessment of energy performance of buildings 2017.
- [75] American Society of Heating, Refrigerating and Air-Conditioning Engineers, Atlanta. ASHRAE Handbook—1981 Fundamentals - Chapter 22 Ventilation and Infiltration. Building Services Engineering Research and Technology 1981;2: 193–193.

- [76] M. Atamaca, E. Kalaycıoğlu, Z. Yilmaz, Evaluation of the Heating & Cooling Energy Demand of a Case Residential Building by Comparing The National Calculation Methodology of Turkey and EnergyPlus through Thermal Capacity Calculations. ICEBO - International Conference for Enhanced Building Operations, 2011.
- [77] A. Costantino, E. Fabrizio, A. Ghiggini, M. Bariani, Climate control in broiler houses: A thermal model for the calculation of the energy use and indoor environmental conditions, *Energ. Buildings* 169 (2018) 110–126, <https://doi.org/10.1016/j.enbuild.2018.03.056>.
- [78] P. Jafarpur, U. Berardi, Effects of climate changes on building energy demand and thermal comfort in Canadian office buildings adopting different temperature setpoints, *Journal of Building Engineering* 42 (2021), 102725, <https://doi.org/10.1016/j.jobe.2021.102725>.
- [79] E. Elnagar, B. Köhler, Reduction of the Energy Demand With Passive Approaches in Multifamily Nearly Zero-Energy Buildings Under Different Climate Conditions, *Front. Energy Res.* (2020) 8, <https://doi.org/10.3389/fenrg.2020.545272>.
- [80] Elnagar E, Lemort V. Cooling Concepts for Residential Buildings: A Comparison Under Climate Change Scenarios. International High Performance Buildings Conference, 2022.
- [81] G. Tan, L.R. Glicksman, Application of integrating multi-zone model with CFD simulation to natural ventilation prediction, *Energ. Buildings* 37 (2005) 1049–1057, <https://doi.org/10.1016/j.enbuild.2004.12.009>.
- [82] J. Koeln, B. Keating, A. Alleyne, C. Price, B.P. Rasmussen, Multi-zone Temperature Modeling and Control, in: J.T. Wen, S. Mishra (Eds.), *Intelligent Building Control Systems: A Survey of Modern Building Control and Sensing Strategies*, Springer International Publishing, Cham, 2018, pp. 139–166, https://doi.org/10.1007/978-3-319-68462-8_6.
- [83] D.N. Karger, D.R. Schmatz, G. Dettling, N.E. Zimmermann, High-resolution monthly precipitation and temperature time series from 2006 to 2100, *Sci. Data* 7 (2020) 248, <https://doi.org/10.1038/s41597-020-00587-y>.
- [84] M. Collins, K. Ashok, M. Barreiro, M.K. Roxy, S.M. Kang, T.L. Frölicher, G. Wang, R. G. Tedeschi, Editorial: New Techniques for Improving Climate Models, Predictions and Projections, *Front. Clim.* 3 (2021), 811205, <https://doi.org/10.3389/fclim.2021.811205>.
- [85] B.J. Soden, W.D. Collins, D.R. Feldman, Reducing uncertainties in climate models, *Science* 361 (2018) 326–327, <https://doi.org/10.1126/science.aau1864>.
- [86] Belgian Science Policy. PROJECT LEHR: LOW ENERGY HOUSING RETROFIT n.d. <http://www.lehr.be/> (accessed August 13, 2023).

Appendix E

Chapter 05: *Application of integrating resilient cooling technologies in building stock: Impact on thermal comfort, final energy consumption, and GHG emissions. (In Review)*

The manuscript will be updated online once Chapter 05 is published.

Appendix F

Chapter 06: *Impact of integration of electric and gas heat pumps on the final energy consumption of Belgian residential building stock.*

Impact of integration of electric and gas heat pumps on the final energy consumption of Belgian residential building stock

Essam Elnagar ^a, Camila Davila ^a, Vincent Lemort ^a

^a Thermodynamics Laboratory, Aerospace and Mechanical Engineering Department, Faculty of Applied Sciences, Université de Liège, Belgium, essam.elnagar@uliege.be

Abstract. The paper investigates the evolution of electricity-driven and gas-driven heat pumps technologies used for heating in the residential building stock in Belgium in the market. A base and predictive scenarios are considered. The base scenario includes the current share of the existing heat pumps in the Belgian market while the predictive scenario considers the increased share of the studied heating systems based on the evolution of the buildings envelope over the period 2020-2050. Two different types of heat pumps are considered, one driven by electricity which performance indicators are based on the literature, while experimental data is used for natural gas-driven heat pumps. The latter is modeled in an empirical way based on the system operating conditions and weather data. This paper presents the entire housing stock in Belgium which is divided in 752 cases. A tree structure model defining Belgian housing typology was created, characterizing Belgian residential building stock in terms of various parameters like building age, scale, level of insulation and energy vectors. A weighting factor to represent their occurrence in the existing Belgian building stock is associated to each building type. To study the impact on the load profile and the final energy consumption, the penetration of the selected heat pumps is calculated through the base and predictive scenarios. The penetration rates obtained of 67.6% and 42.7% for electricity and gas-driven HPs respectively, will allow to carry out some production planning for energy suppliers, manufacturers, and policymakers. Finally, the evolution of the sizing criteria in the future will have an impact on the penetration rates of the studied systems and must not be neglected.

Keywords. energy consumption, heating demand, heat pumps, residential buildings

DOI: <https://doi.org/10.34641/clima.2022.102>

1. Introduction

Buildings in the EU account for 40% of our energy consumption and 36% of our greenhouse gas emissions [1]. European countries are developing strategies to reduce energy consumption in buildings and the associated CO₂ emissions [2]. In long-term scenarios, energy use is very important to be taken into account, particularly in the residential sector, by looking at energy end uses, which gives a better understanding of the evolution of energy use and the possible impacts and adaptation of climate change on energy use. In most European countries, the amount of energy required for heating is greater by far than the energy used for space cooling [3]. Climate change has drawn great attention in recent years because of its large impact on many aspects of building energy use [4,5]. In Belgium, the residential energy needs for space heating and domestic hot water are mainly met by fuel oil, gas or electricity supplied by the grid. The present research aims at assessing the impact of contrasting penetration scenarios of technologies

such as heat pumps.

In Belgium, gas boilers have been for years the most common heating device used due to an extensive gas network available and the relatively low gas prices. Year after year, the European Energy Performance of Buildings Directive (EPBD) imposes more demanding targets, increasing heat pumps installations since it has become more and more difficult to achieve the requirements without using renewable technologies [6].

The benefits associated with these technologies are not only energetic but also environmental. A study by Famiglietti, et al. [7] shows that the impact over the entire life cycle of a Gas Absorption Heat Pump (GAHP) offers a lower environmental impact compared to a traditional boiler mainly because of the lower amount of natural gas (NG) needed in the use phase, representing an average reduction of 27% of CO₂ eq and a reduction of 25% of fossil resource consumption.

Even if the heat pump market share in Belgium remains low (around 10% in 2014), this group of

technologies has been growing steadily since 2013. Just in 2018, the market increased by almost 10% compared to 2017 [8], a trend that would continue in the coming years. Even though most of the statistics point to electric heat pumps, the high electricity prices are opening the market to alternative technologies such as thermally driven heat pumps, making them well suited not only for new buildings but also for the existing ones since they can heat water to high temperatures in a very efficient way offering substantial cost and energy savings thanks to the involved technologies [9].

The aim of this paper is to assess the impact of heat pumps evolution in different scenarios (Electricity-driven heat pumps) and (Gas-driven heat pumps) on the annual consumptions of the residential building stock as well as the impact on the CO₂ emissions. In addition to that, A business-as-Usual Scenario (BAU) is investigated up to the horizons 2030 and 2050 by considering the construction, demolition and renovation rates of the buildings. The Energy simulations are conducted with MATLAB.

2. Methodology

The methodology used in this paper is based on the modeling of the energy end-use consumptions. This study uses a forward method for building energy use with a physical description of various parameters (e.g., building geometry, location, characteristics and operating schedules). According to ASHRAE, the forward method is more suited for improvements due to its higher level of details, compared to the data-driven method [10].

This paper also used an updated model of the tree structure model representing the Belgian residential building stock developed by Gendebien et. al [11].

2.1 Building Stock (Base Scenario-up to 2012)

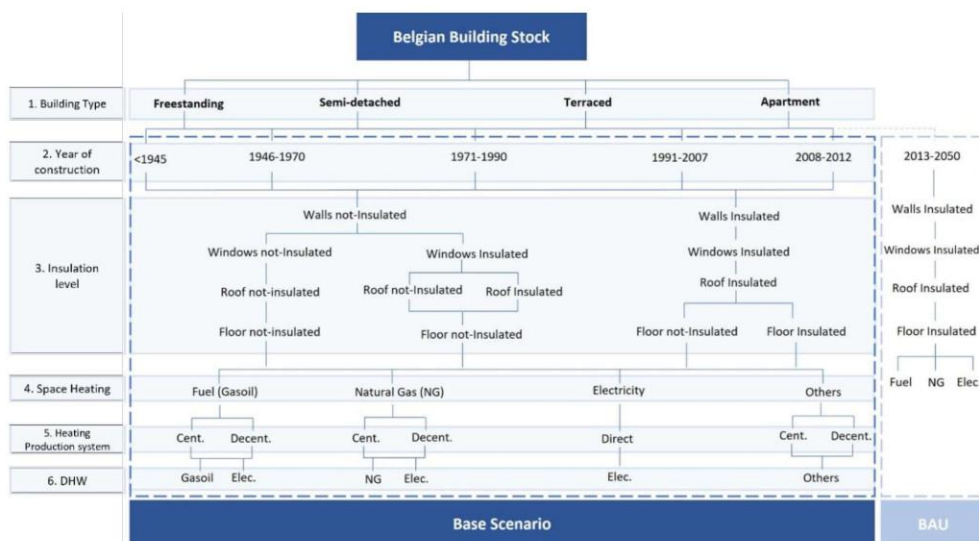

Fig. 1 - Belgian building stock tree structure

The Belgian building stock tree structure is based on a hybrid approach (mix between typical and representative approaches). In the typical approach, a set of typical buildings closely related to the existing buildings are chosen, while a set of fictional buildings based on average values are selected in the representative approach. As shown in Fig. 1, the final tree structure of the base scenario is based on different parameters:

1. Building type (freestanding, semi-detached, terraced and apartment).
2. Year of construction (<1945, 1946-1970, 1971-1990, 1991-2007 and 2008-2012)
3. Insulation level for the building envelope (wall, window, roof and floor).
4. Space heating "SH" (fuel oil, NG, electricity and others (coal, wood,...)).
5. Heating production system (centralized, decentralized).
6. Domestic Hot Water "DHW" (fuel oil, NG, electricity and others (coal, wood,...)).

The final tree structure presents 752 cases representing the whole Belgian building stock till 2012, each case is characterized by the aforementioned parameters.

The simplified building model of a zone is based on the simple hourly method described in ISO13790-2007 [12]. The method is based on the thermal-electrical analogy between the analyzed thermal zone and the equivalent 5R-1C (5 resistances and 1 capacity). The thermal-electrical network is characterized by temperature nodes (θ), thermal resistances ($1/H$), heat fluxes (Φ) and a capacity (C_m) [13]. The 5 resistances in the network are used to describe the heat transfers coefficients, while the thermal mass is represented by a single thermal capacity C_m .

Fig. 2 (a) shows the distribution of Belgian dwelling types for the base scenario, it can be seen that the freestanding houses have the highest share by 29.2%. Fig. 2 (b) also presents the energy mix of the different energy sources used for SH; the SH energy

needs are mainly met by NG and liquid fuels for boilers by 50.14% and 40.02% respectively, while the electricity and other energy sources represent the lowest distribution.

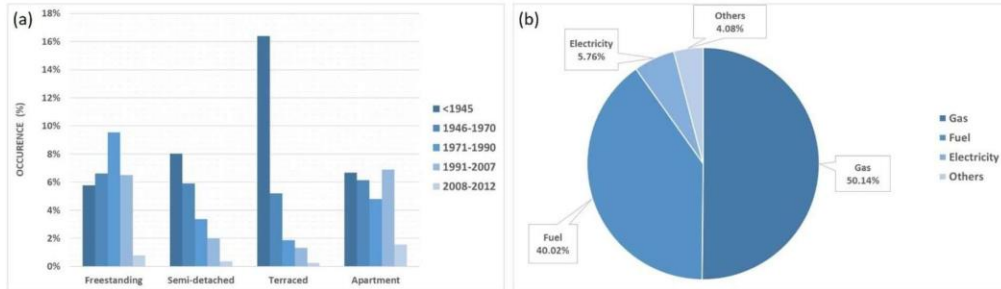

Fig. 2 - Base scenario (up to 2012) (a) Distribution of the Belgian dwelling types differentiating the five construction periods (b) Distribution of energy sources used for SH.

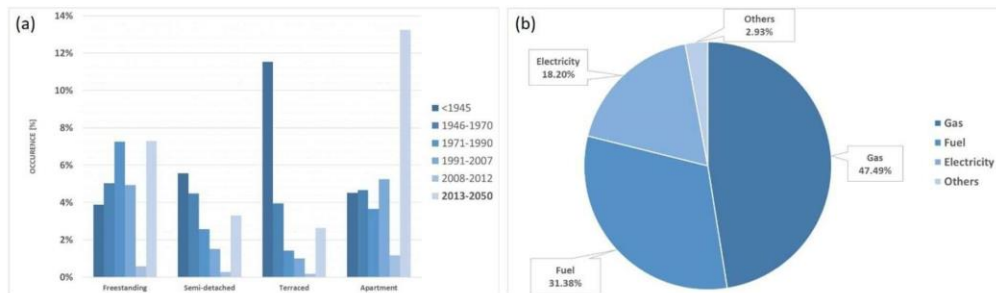

Fig. 3 - BAU scenario (up to 2050) (a) Distribution of the Belgian dwelling types differentiating the six construction periods (b) Distribution of energy sources used for SH.

2.2 Weather Data

The recent decades have seen a major concern about global warming and climate change. This study also aims to upscale the impact of climate change on future heating consumption and to evaluate the minimum indoor temperature used for sizing the heat pumps in Belgium.

The regional climate model used in this study is the “Modèle Atmosphérique Régional” model (hereafter called “MAR”) [14]. Since MAR is a regional model, it must be forced by a global model. Therefore, the atmospheric conditions from a general circulation model (GCM) must be directly forced to the boundaries of the MAR domain every 6 hours. MAR Model runs at 5 km spatial resolution over the Belgian territory as shown in Fig. 4. In this study MAR is forced by the global model BCC-CSM2-MR (called BCC hereafter) [15] with both scenarios historical (1960-2014) and ssp585 (2015-2100) from the CMIP6 project [16]. MAR-BCC is the ensemble mean of all the MAR simulations, compared to MAR-MPI (the coldest) and MAR-MIR (the warmest) [14]. In this study MAR-BCC model is used for the SSP585.

2.3 Future Scenarios

In the future scenarios, the tree structure is then extended for the period 2013–2050 as shown in Fig. 1. The new dwellings that are constructed in this

period are fully insulated. In addition to that, two scenarios are assessed to calculate the maximum penetration rate of electricity-driven and gas-driven heat pumps in the building stock and their impact on the overall building stock energy use.

The performance of electricity-driven heat pumps is based on the performance map provided by different manufacturers, while the gas-driven heat pump performance is based on laboratory tests.

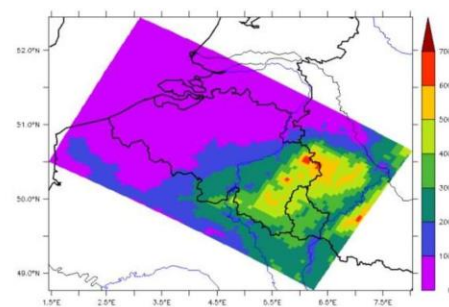

Fig. 4 - Topography (in meters above sea level) of the MAR domain representing Belgian territory [13].

- **Business-as-Usual (BAU-up to 2050)**

The BAU scenario is the first step to update the building stock for the new dwellings, insulation characteristics and the energy sources used for SH and DHW for the period 2013-2050. Based on the Long term renovation strategies of Wallonia and Flanders in Belgium, an average annual construction and demolition rates are set respectively to 0.8% and 0.075%. In addition to that, a total of 1.3% per year renovation rate is counted to renovate the different buildings. The priority was given first to the older non-insulated and after to the partially insulated buildings.

Fig. 3 (a) shows the expected distribution of the newly constructed dwellings between 2013-2050, the number of dwellings for the reference year 2012 was 4,675,433 buildings which increased by 0.348% in 2050 to reach 6,152,311 dwellings. Fig. 3 (b) represents the distribution of energy sources used for SH in 2050. It can be seen that the electricity share is 18.20% compared to 5.76% in the base scenario because of the policies and regulations to increase the share of electricity and to ban the use of oil boilers for the newly constructed buildings and NG connections for the large apartments as well [17]. The share of NG and fuel is also reduced compared to the base scenario in 2012.

- **Electricity-Driven Heat Pump Scenario**

The electricity-driven heat pump scenario is characterized by the maximum penetration rate of air-source heat pumps used for SH and DHW production. The heat pumps are modeled using polynomial laws to fit with the performance maps provided by the manufacturers for the different machines.

The model gives the heating capacity at full load and the COP at full load (COP_{FL}) as a function of two variables; the outside air temperature ($T_{air,out}$) and the temperature of the heating fluid at the outlet of the condenser (T_w).

This polynomial model gives accurate results when the working conditions are close to the full load conditions, in order to predict the performance of a heat pump better, a third order law has been chosen. The model has been calibrated with an air-to-water heat pump Viessmann Vitocal 300-A.

The energy input ratio at full load ($EIRFT$) is calculated as a function of ΔT as shown in equation (1) and the capacity at full load ($CAPFT$) is also calculated as a function of ΔT as shown in equation (3).

$$EIRFT = \frac{COP_n}{COP_{fl}} = C_0 + C_1 * \Delta T + C_2 * \Delta T^2 + C_3 * \Delta T^3 \quad (1)$$

$$\Delta T = \frac{T_{air,out}}{T_w} - \left(\frac{T_{air,out}}{T_w} \right)_n \quad (2)$$

$$CAPFT = \frac{\dot{Q}_{FL}}{\dot{Q}_n} = D_0 + D_1 * (T_{air,out} - T_{air,out,n}) + D_2 * (T_w - T_{w,n}) \quad (3)$$

At part load, the energy input ratio is also calculated ($EIRFPLR$) to give the performance at part load as shown in equation (4).

$$EIRFT = \frac{\dot{W}_{PL}}{\dot{W}_{FL}} = K_1 + (K_2 - K_1) * PLR + (1 - K_2) * PLR^2 \quad (4)$$

$$PLR = \frac{\dot{Q}_{PL}}{\dot{Q}_{FL}} \quad (5)$$

Where:

C0 = 1.01283
C1 = -9.6421
C2 = 65.2973
C3 = 359.06
D0 = 0.973861827
D1 = 0.025752873
D2 = -0.00340588
K1 = 0
K2 = -0.82

In this scenario, the priority of the production is given to the DHW as the backup is used for SH (if there is a backup system in the building) and for SH and DHW simultaneously if there is no backup system in the building.

Three different types of heat pumps were considered for the sizing depending on the overall U-value of the building as shown in Tab. 1, Low temperature heat pumps are selected when the average U-value is below 0.3 W/m²K which is related to the EPB legislation in Belgium, high-temperature HPs are selected for U-value higher than 0.8 W/m²K and medium temperature for U-value between 0.3 and 0.8 W/m²K.

Tab. 1 – Electricity-driven HP selection and sizing.

U-value [W/m ²]	HP Type	Heating power [kW] (\dot{Q}_in)
$U_{avg} < 0.3$	Low T HP (Air 7°C/ Water 35°C)	4.4 to 16
$0.3 < U_{avg} < 0.8$	Medium T HP (Air 7°C/ Water 45°C)	11 to 16
$U_{avg} > 0.8$	High T HP (Air 7°C/ Water 65°C)	11 to 16

The criteria for determining whether or not a heat pump may be placed in a given building is based on a stationary balance that takes into account the building SH and DHW loads, by considering a maximum rating power of 8.6 kW at -10°C, and 80% of the loads at these conditions. Currently, the minimum outdoor temperature used in sizing in the heating seasons -10°C according to the ecodesign requirements [18].

- **Gas-Driven Heat Pump Scenario**

In order to expand the energy sources used for the same technology, a gas-driven absorption heat pump (GAHP) is proposed as a second scenario. Designed for SH and DHW production for residential applications, the appliance has been tested and the results obtained are used to develop a model compatible with that of buildings. The GAHP has a nominal heating capacity of 18.9 kW and its main features are shown in Tab. 2.

Tab. 2 - Main characteristics of the selected GAHP.

Heating power	Air 7°C / Water 50°C 17.6 kW
	Air 7°C / Water 35°C 18.9 kW
GUE efficiency (relative to LCV)*	Air 7°C / Water 50°C 157%
	Air 7°C / Water 35°C 169%
Elec. Power absorption	0.35 kW
Heating capacity	11.4 kW (nominal, relative to LCV, 1013 mbar - 15°C)
	11.2 kW (real)

* Gas utilization efficiency; efficiency index of gas heat pumps, equal to the ratio between the thermal energy produced and the energy of fuel used (relative to low calorific value).

The system is based on the Water-Ammonia absorption cycle using outdoor air as the low-temperature heat source and NG combustion as high-temperature heat source; the delivered hot water is the medium-temperature heat sink. The working principle of the system is represented in the diagram shown in Fig. 5.

To reduce its pressure, the refrigerant leaving the COND is throttled by means of a restrictor valve and cooled down inside the Pipe-in-Pipe heat exchanger (PiPHx); then, by means of a second restrictor valve, is brought to the ideal pressure and temperature conditions before entering the Evaporator (EVAP) where the liquid refrigerant is evaporated by taking heat from the surrounding air. Then, the low-pressure vapor ammonia is overheated in the PiPHx before being sent to the Solution Cooled Absorber (SCA), where it meets the poor refrigerant solution coming from the GEN. The pressure of the incoming solution is reduced by a third restrictor valve.

Since the absorption process is an exothermic reaction, the solution is sent to the Water Cooled Absorber (WCA) where a considerable amount of thermal energy is transferred to the water of the heating circuit. Once the absorption is completed, the solution is pumped back to the GEN using a Solution Pump (SP).

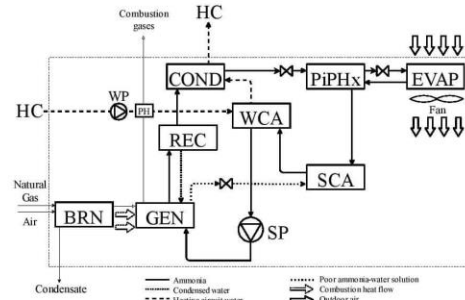

Fig. 5 - Gas absorption heat pump schematic.

The system is installed and tested in a climatic chamber to vary and control the temperature and humidity conditions. From the performance map and the tests conducted in the laboratory, a simple model based on an ordinary least squares linear regression is developed.

The model should give the Heating Capacity at full load ($\dot{Q}_{HC,FL}$) as a function of outdoor temperature (T_{out}), delivery water temperature ($T_{delivery}$) and specific humidity (ω), as shown in Equation (6). The COP at full load (COP_{FL}) depends on the same variables as shown in Equation (7).

$$\dot{Q}_{HC,FL} = f(T_{air,out}, T_w, W_{out}) \quad (6)$$

$$COP_{FL} = g(T_{air,out}, T_w, W_{out}) \quad (7)$$

The part load ratio (PLR) is the ratio of the heating capacity at part load ($\dot{Q}_{HC,PL}$) to the heating capacity at full load as expressed in Equation (8). This ratio is an input and must be a number between 0 and 1 since the heating capacity varies proportionally with the modulation of the system.

$$PLR = \frac{\dot{Q}_{HC,PL}}{\dot{Q}_{HC,FL}} \quad (8)$$

The same approach is used to model the inputs to the system, in this case, the gas heat input and electrical input (consumption of fans and electronics) are defined as \dot{Q}_{gas} and \dot{W}_{in} in Equations (9) and (10). The gas heat input varies according to the water delivery temperature and outdoor temperature, in addition to the modulation of the system; the electrical consumption depends on the modulation of the system thus it is modeled as a function of the part load ratio and represented as a linear proportion.

$$\dot{Q}_{gas} = h(T_{out}, T_{delivery}, PLR) \quad (9)$$

$$\dot{W}_{in} = i(PLR) \quad (10)$$

The obtained coefficients for the linear model are such that the residual sum of squares between the observed targets in the dataset and the targets predicted by the linear approximation is minimized. The results are shown in Equations (11), (12), (13) and (14). The R^2 of each formula is defined as $1 - (u/v)$, where u is the residual sum of squares and v is the total sum of squares; the best possible score for

R^2 is 1.

$$\dot{Q}_{HC,FL} = 0.0958 T_{out} - 0.1809 T_{delivery} + 146.192 \omega + 25.0752 \quad 0.89 \quad (11)$$

$$COP_{FL} = 0.0059 T_{out} - 0.0118 T_{delivery} + 15.1612 \omega + 1.6759 \quad 0.86 \quad (12)$$

$$\dot{Q}_{gas} = -0.00287 T_{out} - 0.0164 T_{delivery} + 11.9143 PLR + 2.9169 \quad 0.89 \quad (13)$$

$$\dot{W}_{in} = 0.2762 PLR + 0.0540 \quad 0.91 \quad (14)$$

The obtained formulas are evaluated for the experimental conditions from which the performance map is obtained. The results are within the order of magnitude and show the same trends and behavior observed during the experimental tests performed with small variations explained by the R^2 value of each formula.

In this scenario, the same criteria has been used to determine if a heat pump can be installed or not by considering a maximum rating power of 16.9 kW at -10°C, based on the manufacturer data. In addition to that the same sizing criteria is also used to size the GAHP according to the overall U-value of the building.

3. Results and Discussion

The results of the base scenario are shown in Fig. 6, comparing the total SH and DHW energy consumption in 3 different periods. It can be seen at Fig. 6 (a) that there is a slight change in the distribution of energy sources used for SH and DHW as there was no change in the building stock, while there is a significant decrease in the total SH and DHW consumption. In the base scenario with a reference year using TMY (2001-2020), the total SH and DHW consumption was 102184 GWh and it decreased to 81320 GWh and 77825 GWh in (2041-2060) and (2081-2100) respectively.

Fig. 6 (b) also shows the average consumption per dwelling in the 3 periods for the base scenario. It decreased from 21.86 MWh in (2001-2020) to 17.40 MWh in (2041-2060) and 16.65 MWh in (2081-2100). It can also be seen that the CO₂ emissions decreased for an average dwelling from 5.10 ton CO₂ to 3.88 ton CO₂. The emission factors for electricity, gas, fuel and others in Belgium are 0.160 kg/kWh, 0.202 kg/kWh, 0.267 kg/kWh and 0.342 respectively [19,20].

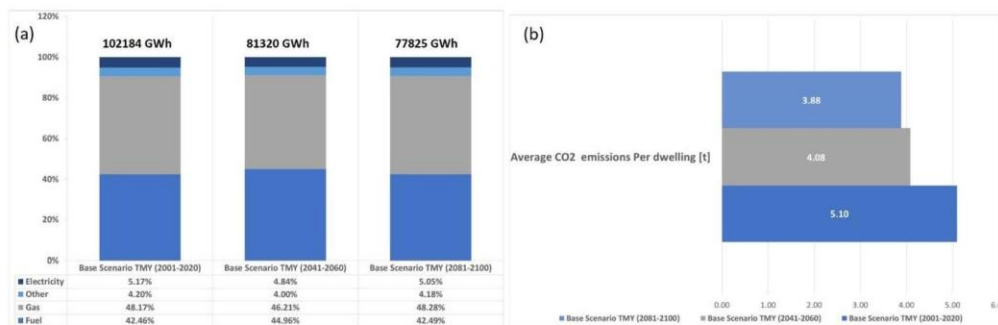

Fig. 6 - Comparison between the SH and DHW energy consumption in the Base Scenario in different years (a) Total SH and DHW energy consumption (b) average CO₂ emissions per dwelling.

For the BAU Scenario, the building stock has been updated as shown before in Fig. 3. The new distribution of the buildings has been used to simulate the electricity-driven heat pumps scenario and to calculate the maximum penetration rate of both heat pumps in the building stock and their impact on the overall building stock energy use.

Fig. 7 shows the maximum penetration rate of the electricity-driven heat pumps. Based on the criteria mentioned before, 67.6% is the maximum possible penetration rate of the electricity-driven HPs in 2050 Horizon. It can also be seen that in the electricity-driven HPs scenario, the NG and fuel share amongst the whole building stock decreased to 15.5% and 15% respectively compared to their share in the BAU scenario as shown in Fig. 3.

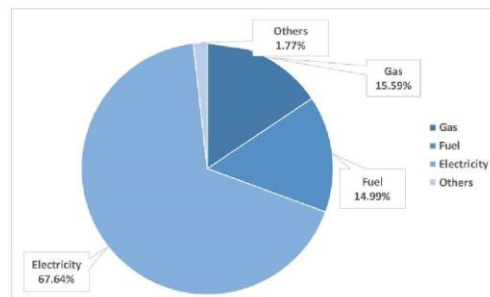

Fig. 7 - Electricity-driven HP scenario - distribution of energy sources used for SH.

The increase of the electricity share has also an impact on the total SH and DHW energy consumption of the building stock as shown in Fig. 8.

It can be seen that electricity represents 45.4% of the total SH and DHW energy consumption in the

electricity-driven HPs scenario compared to 13.64% in the BAU scenario.

The total SH and DHW energy consumption decreased by 3.23% in the electricity-driven HPs scenario compared to the BAU scenario and the consumption per average dwelling decreased from 15.6 MWh in the BAU scenario to 15.1 MWh in the electricity-driven HPs scenario.

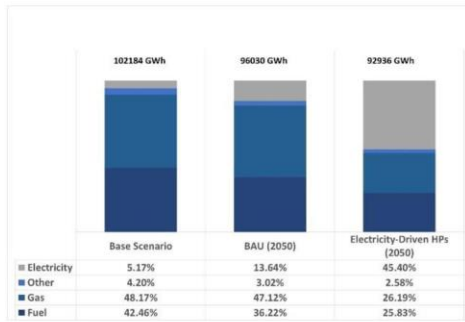

Fig. 8 - Comparison between the total heating energy consumption in the Base scenario, BAU scenario and electricity-driven HPs scenario.

For the gas-driven HPs scenario, based on the same criteria of installing a GAHP with a maximum power of 16.9 kW at -10°C. The maximum penetration rate of GAHP is 42.7% by 2050, compared to the distribution of NG source in BAU scenario in 2050 which is 47.5% as shown in Fig. 3(b). The share of the GAHP represents 89.92% of the total number of buildings that use NG for SH and DHW purposes as shown in Fig. 9.

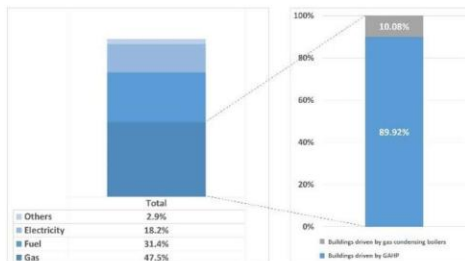

Fig. 9 - Gas-driven HP scenario - share of GAHP amongst the buildings that use NG for SH and DHW.

Fig. 10 compares between the total heating energy consumption in the gas-driven HP scenarios, BAU scenario as well as the base scenario. The total heating consumption for SH and DHW in the gas-driven HP scenario is 4.5% lower than the BAU scenario.

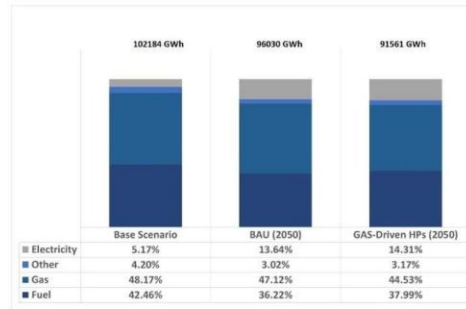

Fig. 10 - Comparison between the total heating energy consumption in the Base scenario, BAU scenario and gas-driven HPs scenario.

The results also show that the minimum outdoor temperature is increasing in the coming years. Compared to the reference year TMY(2001-2020), there are 26 hours when the Temperature is below -10°C, while in the period (2081-2100), the minimum outdoor temperature is -5°C for 3 hours. Based on those results, the minimum outdoor temperature used in the criteria to determine the maximum penetration rate of HPs is updated to -5°C. The change in the maximum penetration rate is not significant, it has been found that the electricity-driven heat pumps penetration rate increases from 67.6% to 68.9% and the gas-driven heat pumps penetration rate will increase from 42.7% to 43.5%.

4. Conclusion

In this paper, a bottom-up approach has been updated to describe the Belgian building stock with the base scenario and BAU scenario. The results show that, climate change has a significant impact on the energy use of buildings, by 2100 the SH and DHW energy consumption for the whole building stock decreased by 23.8%.

In the second step, the evolution of the building stock till 2050 has been updated while taking into consideration the construction, demolition and renovation rates in the BAU 2050 scenario. The distribution of energy sources used for SH and DHW has been changed compared to the base scenario.

The paper also investigates two different scenarios to calculate the maximum penetration rate of heat pump technologies used for SH and DHW in the residential buildings in Belgium. In the first scenario, the maximum penetration rate of electricity-driven HPs is 67.6%, while the maximum penetration rate of GAHP is 42.7%.

The evolution of temperatures in the coming years showed that increasing the minimum indoor temperature used in the sizing criteria for the HPs to -5°C instead of -10°C, will also have an impact on the maximum penetration rate of both HPs.

5. Acknowledgment

This research was partially funded by the Walloon Region under the call 'Actions de Recherche Concertées 2019 (ARC)' and the project OCCuPANT, on the Impacts Of Climate Change on the indoor environmental and energy PerformAnce of buildiNgs in Belgium during summer. The authors would like to gratefully acknowledge the Walloon Region and Liege University for funding.

6. References

- [1] European Commission. Directorate General for Energy. Good practice in energy efficiency :for a sustainable, safer and more competitive Europe. LU: Publications Office; 2017.
- [2] Nishimwe AMR, Reiter S. Building heat consumption and heat demand assessment, characterization, and mapping on a regional scale: A case study of the Walloon building stock in Belgium. *Renewable and Sustainable Energy Reviews* 2021;135:110170. <https://doi.org/10.1016/j.rser.2020.110170>.
- [3] Ürge-Vorsatz D, Cabeza LF, Serrano S, Barreneche C, Petrichenko K. Heating and cooling energy trends and drivers in buildings. *Renewable and Sustainable Energy Reviews* 2015;41:85–98. <https://doi.org/10.1016/j.rser.2014.08.039>.
- [4] Wang H, Chen Q. Impact of climate change heating and cooling energy use in buildings in the United States. *Energy and Buildings* 2014;82:428–36. <https://doi.org/10.1016/j.enbuild.2014.07.034>.
- [5] Radhi H. Evaluating the potential impact of global warming on the UAE residential buildings – A contribution to reduce the CO2 emissions. *Building and Environment* 2009;44:2451–62. <https://doi.org/10.1016/j.buildenv.2009.04.006>.
- [6] European heat pump association. *European Heat Pump Market and Statistics Report 2014*. 2014.
- [7] Famiglietti J, Toppi T, Pistocchini L, Scoccia R, Motta M. A comparative environmental life cycle assessment between a condensing boiler and a gas driven absorption heat pump. *Science of The Total Environment* 2021;762:144392. <https://doi.org/10.1016/j.scitotenv.2020.144392>.
- [8] Association of the European heating industry. *Heating Market Report 2020*. 2020.
- [9] Keinath CM, Garimella S. An energy and cost comparison of residential water heating technologies. *Energy* 2017;128:626–33. <https://doi.org/10.1016/j.energy.2017.03.055>.
- [10] Ashrae handbook: Fundamentals. Atlanta: Ashrae; 2013.
- [11] Gendebien S, Georges E, Bertagnolio S, Lemort V. Methodology to characterize a residential building stock using a bottom-up approach: a case study applied to Belgium. *International Journal of Sustainable Energy Planning and Management* 2015:71-88 Pages. <https://doi.org/10.5278/IJSEPM.2014.4.7>.
- [12] International Standard Organization. *Energy performance of buildings. Calculation of energy use for space heating and cooling*: BSI British Standards; 2007. <https://doi.org/10.3403/30133624>.
- [13] El Nagar E, Doutreloup S, Lemort V. *Modeling the Impact of Climate Change on the Future Heating Demand in Different Types of Buildings in the Belgian Residential Building Stock 2021*.
- [14] Sebastien D, Fettweis X, Rahif R, Elnagar E, S. Pourkiaei M, Amaripadath D, et al. *Historical and Future Weather Data for Dynamic Building Simulations in Belgium using the MAR model: Typical & Extreme Meteorological Year and Heatwaves 2022*.
- [15] Wu T, Yu R, Lu Y, Jie W, Fang Y, Zhang J, et al. *BCC-CSM2-HR: A High-Resolution Version of the Beijing Climate Center Climate System Model*. *Climate and Earth system modeling*; 2020. <https://doi.org/10.5194/gmd-2020-284>.
- [16] O'Neill BC, Tebaldi C, van Vuuren DP, Eyring V, Friedlingstein P, Hurtt G, et al. *The Scenario Model Intercomparison Project (ScenarioMIP) for CMIP6*. *Geosci Model Dev* 2016;9:3461–82. <https://doi.org/10.5194/gmd-9-3461-2016>.
- [17] Government of Flanders. *LONG-TERM STRATEGY FOR THE RENOVATION OF FLEMISH BUILDINGS*. n.d.
- [18] Commission Regulation (EU). *Commission Regulation (EU) No 206/2012 of 6 March 2012 implementing Directive 2009/125/EC of the European Parliament and of the Council with regard to ecodesign requirements for air conditioners and comfort fans* Text with EEA relevance. 2012.
- [19] International Energy Agency (IEA). *Data & Statistics*. IEA n.d. <https://www.iea.org/data-and-statistics/data-browser> (accessed March 31, 2022).
- [20] Koffi B, Cerutti A, Duerr M, Iancu A, Kona A, Janssens-Maenhout G. *Covenant of Mayors for Climate and Energy: Default emission factors for local emission inventories – Version 2017*. JRC Publications Repository 2017. <https://doi.org/10.2760/290197>.