



BULLETIN DE L'INSTITUT FRANÇAIS D'ARCHÉOLOGIE ORIENTALE

en ligne en ligne en ligne en ligne en ligne en ligne en ligne en ligne en ligne en ligne en ligne

BIFAO 114 (2014), p. 455-518

Nico Staring

The Tomb of Ptahmose, Mayor of Memphis Analysis of an Early 19th Dynasty
Funerary Monument at Saqqara

Conditions d'utilisation

L'utilisation du contenu de ce site est limitée à un usage personnel et non commercial. Toute autre utilisation du site et de son contenu est soumise à une autorisation préalable de l'éditeur (contact AT ifao.egnet.net). Le copyright est conservé par l'éditeur (Ifao).

Conditions of Use

You may use content in this website only for your personal, noncommercial use. Any further use of this website and its content is forbidden, unless you have obtained prior permission from the publisher (contact AT ifao.egnet.net). The copyright is retained by the publisher (Ifao).

Dernières publications

9782724707700	<i>La chapelle-reposoir de barque de Philippe Arrhidée</i>	Christophe Thiers, Charlie Labarta, Anaïs Tillier
9782724707618	<i>The Island City of Tinnis</i>	Alison L. Gascoigne
9782724707991	<i>BAEFE</i>	
9782724707830	<i>BIFAO 120</i>	
9782724707724	???????? ?????????? ?? ???	Laurent Coulon (éd.), Mélanie Cressent (éd.)
9782724707731	<i>French Archaeology in Egypt</i>	Laurent Coulon (éd.), Mélanie Cressent (éd.)
9782724707656	<i>Ports and Fortifications</i>	Stéphane Pradines (éd.)
9782724707755	<i>MIDEO 35</i>	Emmanuel Pisani (éd.), Dennis Halfit (éd.)

The Tomb of Ptahmose, Mayor of Memphis Analysis of an Early 19th Dynasty Funerary Monument at Saqqara

NICO STARING*

Introduction

In 2005 the Metropolitan Museum of Art, New York, acquired a photograph taken by French Egyptologist Théodule Devéria (fig. 1, 2).¹ The albumen silver print image measures 21,2 × 28,1 cm, irregularly trimmed, and was produced from a paper negative.² The photo is titled in the negative, near the bottom of the image: “T. Devéria phot. 1859. Sakkarah (Memphis). Tombeau de Ptah-mès”. This is the tomb of Ptahmose, the early 19th Dynasty Mayor of

* Macquarie University (Sydney, Australia), Faculty of Arts, Department of Ancient History. I would like to thank my doctoral thesis supervisors A/Prof. Boyo Ockinga and Dr. Susanne Binder for their notes, suggestions and commentary from an early stage of conducting this research. I would also like to thank Dr. Beatrix Gessler-Löhr, Prof. Dr. Maarten Raven and Dr. René van Walsem for their useful suggestions and comments on earlier drafts of this article, and the anonymous peer reviewer for valuable, critical remarks. Needless to say that the opinions expressed in this article as well as any mistakes rest solely with the author.

¹ MMA Annual Report 2005, p. 32: “Tomb of Ptahmose, Saqqara (Memphis)”,

accession number 2005.100.321. The albumen silver print was a gift to the museum from Joseph M. Cohen, who purchased it from the Gilman Paper Company Collection which, in turn, acquired the print from Serge Plantureux in Paris. The print initially formed part of the collection of French Egyptologist Eugène Grébaut (1846-1915; DAWSON, UPHILL, BIERBRIER 2012, p. 223). I thank Malcolm Daniel and Meredith Friedman of the Department of Photographs of The Metropolitan Museum of Art, New York, for allowing me to publish this photograph.

² The sheet measures 21,4 × 28,8 cm, irregularly trimmed. Paper photography was invented by the Englishman William Henry Fox Talbot (1800-1877)

and started to replace the daguerreotype in the early 1850s (DANIEL 2008). His calotype process allowed for the production of many prints from a single negative. Gustave Le Gray (1820-1884) from France later (1850) refined this technique by waxing the negatives prior to sensitisation, resulting in a crisper image (DANIEL 2004). He taught photography to the likes of Maxime Du Camp and John Beasley Greene, pioneer photographers in Egypt. Glass negatives were introduced in the early 1850s and were the norm by 1860. Paper negative photography continued to be used during the 1850s, especially for travel photography due to practical reasons (light weight).

BIFAO II4 - 2014

Memphis and Chief steward in the Temple of Ramesses II in the house of Ptah,³ rediscovered in 2010 by the archaeological mission of Cairo University led by Prof. Ola el-Aguizy.⁴ It is located in the New Kingdom necropolis due south of the Unas causeway, roughly halfway between the tombs of Nebnefer and Huynefer (ST 217) to the north, and the Overseer of the treasury Maya to the south. Devéria's photograph presents the only testimony of this part of the tomb of Ptahmose: the reliefs are no longer there. The superstructure was accessible as early as the 1820s when several architectural elements and statues were removed from the structure. These were subsequently distributed to different public and private collections around the world (see *infra*).

The Devéria photograph shows one doorway in the accessible superstructure. The walls are constructed of mudbrick while limestone revetment blocks bear relief decoration. This construction method is characteristic of late 18th Dynasty elite tomb architecture at Saqqara. The two doorjambs are inscribed with four columns of text carved in sunk relief. Rectangular panels are visible below. The panel on the left-hand doorjamb holds the key to identifying the correct tomb owner. It depicts Ptahmose seated in front of an offering table and the inscription contains a number of his titles and his name. Devéria also photographed this panel, which is now in the collection of the Egyptian Museum in Cairo (fig. 3b).⁵

The doorjamb and thickness on the right-hand side appear to have been previously damaged and subsequently repaired. The limestone blocks are crudely reassembled with mortar. In the process, parts of the text and decoration were damaged. The doorjamb thickness contains one column of text and the reveal preserves the representation of the tomb owner and, partly visible, his wife. In front of the tomb owner one can distinguish the lower section of a column of text. The upper course(s) of this wall, once bearing representations of the heads of the couple, are no longer preserved.

Judging from the style and particular details of this relief, one would be inclined to date this representation to the late 18th Dynasty. Such a date would accord well with the architecture. However, previous studies have firmly established Ptahmose in the first half of the reign of Ramesses II.⁶

In this article, the technical and iconographical aspects of this relief are studied and compared to other New Kingdom monuments. First, the circumstances surrounding the tomb's (previous) excavation(s) are discussed along with a biographical note on Th. Devéria. This is followed by an updated list of finds attributable to Ptahmose. Architecture and a detailed study of the texts

³ PM III², p. 713-715: "Chief steward in the Temple of Ramesses II in the house of Ptah, etc., D. 19, temp. Ramesses II or later" (with bibliographical references). For recent studies on Ptahmose, see BERLANDINI 1982, MÁLEK 1987, VAN DIJK 1989, FRANKE 1993, GRECO 2011b. For the name, see *PNI*, p. 140 [9].

⁴ ADLY, GRIMAL 2010, p. 82.

⁵ I thank Denise Faïfe of the musée d'Orsay (Service recherche, documentation) and Gaëlle Le Page of the Réunion des musées nationaux-Grand Palais (Agence photographique) for providing me with information on the photographic collection of Devéria held in the musée d'Orsay. I also thank Stéphane

Pasquali for bringing Devéria's photographic collection in the Musée d'Orsay to my attention. The panel was published previously by BERLANDINI 1982, pl. X.

⁶ See e.g. BERLANDINI 1982; Greco 2011b.

and iconography are the subject of the main part of this article. The present study is concluded with an outline of this official's career, a partial reconstruction of his funerary monument, and a reconsideration of his position in the early 19th Dynasty.

A Biographical Note on Théodule Devéria and the Tomb of Ptahmose until 1859

Charles Théodule Devéria (1831-1871)⁷ was introduced to Egyptology by Émile Prisse d'Avennes,⁸ a friend of the family, who upon his return from Egypt in 1843, ordered a portrait from Théodule's father, the painter and lithographer Achille Devéria.⁹ Th. Devéria's interest in ancient Egypt was nourished further after visiting the Egyptian collection of the museum in Leiden, 1846: "[...] nous avons vu à Leyde un magnifique musée égyptien et indien, qui contient des tombeaux tout entiers [...]]'ai été bien fâché de ne pas pouvoir rester quelque temps au musée égyptien pour y estamper ou y dessiner quelques-unes de ces belles choses [...]".¹⁰ Devéria practised copying Egyptian reliefs held in his father's collection¹¹ and studied Coptic under Charles Lenormant.¹² Upon recommendation of Emmanuel De Rougé,¹³ Devéria was appointed curator at the Egyptian department of the Louvre in 1855, at a time when the collections were being greatly enlarged by the work of Auguste Mariette (1821-1881) in Egypt. In 1858 Devéria travelled to Egypt to accompany Mariette on his excavations. He arrived on December 10th, 1858, and assisted Mariette—who in that year was appointed Director of Antiquities by Said Pasha—as a copyist until April 6th, 1859.¹⁴ Devéria started working at Saqqara, Gizeh and the museum of Bulaq a few days upon his arrival.¹⁵ Both men set sail for Luxor in early January 1859 and returned north in early March. At Saqqara, Devéria produced a fair number of photographs of finds uncovered by Mariette at the Serapeum a few years earlier.¹⁶

⁷ DAWSON, UPHILL, BIERBRIER 2012, p. 475-476.

⁸ DAWSON, UPHILL, BIERBRIER 2012, p. 445-446. For Prisse d'Avennes and the use of photography (by A. Jarrot) during his 1858-1860 expedition, see: BOOM 1994 and AUBENAS 2011.

⁹ A. Devéria 1844, lithograph in the musée d'Annecy (DEWACHTER 1984, fig. 1).

¹⁰ From: letter of Th. Devéria to his father, dated August 14th 1846. Leyde = Rijksmuseum van Oudheden, Leiden. Th. Devéria, aged fifteen, visited The Netherlands with his mother, Céleste Motte, daughter of the lithographic printer Charles Motte (G. DEVÉRIA 1896, IV). Both did not sign the guestbook, kept in the museum archives.

¹¹ DURAND 2013, p. 3.

¹² DAWSON, UPHILL, BIERBRIER 2012, p. 323.

¹³ Vicomte Emmanuel de Rougé (1811-1872): DAWSON, UPHILL, BIERBRIER 2012, p. 475-476.

¹⁴ In 1858-1860 Prisse d'Avennes travelled through Egypt copying the reliefs of a great number of monuments. On May 22nd 1860 Prisse and his team arrived at Saqqara, and stayed there with Mariette for a short while (DE FAMARS TESTAS 1988, p. 178). Although their stay in Egypt overlapped, Willem De Famars Testas, the draughtsman working for Prisse, makes no mention in his diary of meeting with Devéria.

¹⁵ G. DEVÉRIA 1896; ABOU-GHAZI 1897, p. 8; DURAND 2013. A portrait-

drawing of A. Mariette produced by Th. Devéria in 1859 in Ombos, is kept in the collection of the Museum of Fine Arts in Boston, (Acc. No. 1978.571: [http://www.mfa.org/collections/object/portrait-of-auguste-mariette-272653] accessed 18.06.2013). The drawing was probably part of the collection of the Italian Luigi Vassalli (1812-1887). Vassalli went to Egypt in 1841 to work there initially as a portrait painter and dealer. He became Mariette's assistant at several of his excavations, including at Saqqara (TIRADRITTI 1994) in the early 1860s and was appointed as curator and subsequently as director of the Bulaq Museum (1865-83). DAWSON, UPHILL, BIERBRIER 2012, p. 553-554.

¹⁶ DURAND 2013.

Devéria became acquainted with photography through his father in 1854.¹⁷ This explains his early practising of photography in field-archaeology.¹⁸ His optimism towards photography for the benefit of Egyptology is apparent from a passage in a letter addressed to the *Revue archéologique* in 1861, in which he responds to De Rougé who accused Mariette of having made errors in copying a text at Karnak: “Si, malgré cela, cette copie contient des fautes, ce qui n’est pas impossible, je puis contrôler au moyen de mes photographies et lever ainsi presque tous les doutes”.¹⁹ Due to his weak health, Déveria was not able to accompany Mariette the next year. That his presence was duly missed can be deduced from a letter written by M. de Nieuwerkerke addressed to De Rougé: “Vous savez que M. Mariette travaille maintenant très difficilement et qu’on ne peut en tirer la copie d’aucune inscription quand il n’a pas M. Déveria pour aide”.²⁰

Devéria eventually returned to Egypt again, but his weak health remained and he died at the age of forty. His private collection of photographs was donated by his mother to the Musées nationaux, after which they were transferred to the Department of Egyptian Antiquities of the musée du Louvre.²¹ In 1986 the collection of photographs was allocated to the musée d’Orsay in Paris. This collection contains a few more photographs of now-lost New Kingdom tombs at Saqqara, including an identical print of the doorway in the tomb of Ptahmose published here.²² Another substantial number of Devéria’s photographs are kept in the Bibliothèque nationale de France in Paris. That collection interestingly includes a print previously attributed to Arthur Rhoné. Jocelyne Berlandini published a copy of this print in 1982 (fig. 4).²³ It captures another relief in the tomb of Ptahmose, *in situ* but now lost. This print was included in a photographic album prepared by Rhoné in 1885.²⁴ The main scene presents the tomb owner and family members standing on a papyrus boat while fishing and fowling in the marshes. Ever since Berlandini’s publication, this wall has been referred to as the Mur Rhoné. Arthur

¹⁷ A. Devéria was appointed director of the department of engravings of the Bibliothèque nationale de France in 1849, where his son Théodule started work in 1851. For early photographs of father and son, see the family portrait album, prepared from 1853 until A. Déveria’s death in 1857: J. Paul Getty Museum, Los Angeles, 84.XM.485.29. The photographs were enhanced with ink, possibly in preparation for printing lithographs from them. (<http://www.getty.edu/art/gettyguide/artObjectDetails?artobj=46796> accessed 18.06.2013). A. Déveria was the brother of French Romantic painter Eugène Devéria. A portrait of Th. Déveria painted by his uncle is now in the musée du Louvre, RF 2648.

¹⁸ Karl Richard Lepsius already took with him photographic material during his grand expedition to Egypt 1842-1846. He was even personally instructed by British photographic pioneer Fox

Talbot to prepare photographic paper in order to produce calotypes (correspondence in the Fox Talbot Collection, acc. 26034 and doc. 4553, British Library, London). A friend of Devéria, the French-born American John Beasley Greene (1832-1856) is credited as being the first archaeologist to use photography for field-documentation: 1853 at Medinet Habu. He left his negatives to Devéria and these are now in the musée d’Orsay, Paris. The very first photograph taken in Egypt dates to November 7th 1839: a daguerreotype of the harim palace of Muhammed Ali in Ras el-Tin, Alexandria, taken by Frenchmen Frédéric Goupil-Fesquet (1817-1878) and Gaspard Pierre Gustave Joly de Lotbinière (1798-1865). The print is preserved only as a lithographic copy (cf. RAMMANT-PEETERS 1994, p. 6; JACOBSEN 2007).

¹⁹ The letter was never sent to the *Revue archéologique* and was posthumously published in Th. DEVÉRIA 1896. Cf. also BOOM 1994, p. 196.

²⁰ Paris, December 26th, 1861 (G. DEVÉRIA 1896, p. XXIII). De Nieuwerkerke was the ministre d’État responsible for the Musées nationaux.

²¹ Forty volumes of his notes and manuscripts, and sixteen boxes of slips are now kept in the musée du Louvre. Additional papers are held in the Collège de France (DAWSON, UPHILL, BIERBRIER 2012, p. 153).

²² Musée d’Orsay, inv. nr. PHO 1986 144 66; negative: PHO 1986 131 225.

²³ BERLANDINI 1982, p. 86-92, fig. 1, pl. VII.

²⁴ RHONÉ 1885, pl. 16.

Rhoné (1836-1910) was a French author and traveller with a profound interest in ancient Egypt. He travelled the country several times between 1865 and 1882.²⁵ On these visits he was accompanied by his friend A. Mariette, and later by Gaston Maspero (1846-1916), Mariette's successor as head of the Service des antiquités. Devéria met Rhoné in Paris and he may have also joined him on one of his journeys to Egypt. A Devéria photograph dated 1865 depicts a group portrait of "occidental men on a boat". Arthur Rhoné has been tentatively identified as one of the men portrayed.²⁶ The supposed date of 1885 for the Mur Rhoné photograph was erroneously taken as a *terminus post quem* for the eventual destruction of the funerary monument of Ptahmose.²⁷ While Rhoné indeed possessed an identical print, it was Th. Devéria who actually produced that photograph. More prints are held in the Bibliothèque nationale de France, the musée d'Orsay,²⁸ and the J. Paul Getty Institute.²⁹ The prints kept in Paris reveal a short hand-written description: "Sakkarah (Memphis). Tombeau de Ptah-mès. Th. Devéria phot. 1859". It is clear, therefore, that Devéria produced more photographs of what must have undoubtedly been an impressive tomb. As "Mur Rhoné" has become a well-established term in Egyptological literature, and to avoid any confusion, I will continue using the term (in quotation marks) to refer to this scene.

Devéria's brother Gabriel recollected how Devéria was present when Mariette discovered the so-called Saqqara king-list in December 1858: "[...] il assistait à Saqqarah aux fouilles qui aboutirent à la découverte d'une liste de cinquante-huit rois, comptés de Miébidos jusqu'à Ramsès II [...]".³⁰ Devéria produced squeezes of the reliefs,³¹ but no photographs of this find have yet been identified. More funerary monuments of New Kingdom date were excavated in the area south of the step-pyramid. The finds were summarily recorded by Mariette in his *Monuments divers* of 1872, and Devéria produced photographs of a selection of these.³² Since his photographs are signed 1859, they were probably taken when Mariette and Devéria returned from their trip to Upper Egypt in March of that year. In one such photograph Mariette can be observed seated against a *djed*-pillar in the tomb of Khay at Saqqara.³³

From the acquisition data available for objects from the tomb of Ptahmose (*infra*), one is able to highlight some moments in history when this tomb was still accessible. Perhaps the first European visitors arrived at Saqqara in the early 18th c. The (now lost) pyramidion of Tia,

²⁵ DAWSON, UPHILL, BIERBRIER 2012, p. 463-464; Rhoné 1877.

²⁶ Two others are tentatively identified as Henri Pereyre and M. Surell. The J. Paul Getty Museum, Los Angeles, 2009.85.1 (albumen silver print). I thank Ms. Karen Hellman of the J. Paul Getty Museum for sending me an inventory of Devéria material in the museum collection. See also: LAUER 1961, p. 43.

²⁷ GRECO 2011b, p. 196.

²⁸ Musée d'Orsay PHO 1986 144 65.

²⁹ J. Paul Getty Institute, Los Angeles, nr. 2009.85.14. This print is not signed by Devéria.

³⁰ G. DEVÉRIA 1896, p. XII. Relief Cairo CG 34516 (two-sided) from the tomb of the Overseer of works on all monuments of the king, Tjuneroy/Tjel (temp. Ramesses II). Published: MARIETTE 1872, p. 19, pl. 58. The limestone tomb-structure and a stela (probably Cairo JE 18924) of Tjuneroy were found by Luigi Vassalli, working for Mariette as "simple inspecteur" in 1861: MARIETTE 1872, p. 18-19, pl. 57b. Further references: PM III², p. 666-667, including statue Cairo CG 1105 and four canopic jars, Brooklyn Museum 48.30.1-4.

³¹ Devéria squeezes 6165, i.10 (CG 34516); 6170A, 6, 14 (JE 18924). The squeezes are kept at the musée du Louvre.

³² For photographs of the New Kingdom tomb of Khay, Overseer of the Treasury of the Temple of Usermaatre-setepenre (Ramesses II) in the house of Amun (PM III², p. 726; musée d'Orsay inv. nrs. 1986 144 60, MS 178 130 and 1986 144 63, MS 178 133), see: PASQUALI 2013, fig. 10-11. All New Kingdom tombs photographed in 1859 are now "lost".

³³ PASQUALI 2013, fig. 11.

brother-in-law of Ramesses II, was published by the Scottish traveller and author Alexander Gordon in 1737-1739.³⁴ The object left from Alexandria in 1722, becoming one of the earliest Egyptian antiquities to arrive in Great Britain. The statues of Inehyt (II.1-2, *infra*) were the first pieces from the tomb of Ptahmose to have travelled abroad. These most probably derived from the “excavations” of Giovanni d’Anastasi (1780-1860), Greek merchant and later consul-general in Egypt for Norway and Sweden (1820-1827), in the early 1820s,³⁵ as did the objects now in the Rijksmuseum van Oudheden in Leiden.³⁶ His former collection of objects from Saqqara indicates that his agents must have excavated a large number of New Kingdom tombs in the years 1823-1825.³⁷ The tomb of the Chief steward Amenhotep Huy (now lost) was excavated possibly in partnership with Giuseppe di Nizzoli (c.1792/4-1858), an Italian diplomat, chancellor at the Austrian consulate in Egypt (1818-1828) and collector of antiquities.³⁸ His wife Amalia Sola described the location of that tomb: “[...] at Saccarah, near Memphis, on the chain of hills which separates the left bank of the Nile from the sands of the deserts [...] not more than a quarter of an hour from the town of Memphis”.³⁹ Hayes⁴⁰ remarks that *Saccarah* refers not to the plateau stretching from Abusir to Dahshur as it is used nowadays, but to the nearby village. Nizzoli thus designates a specific area near the Apa Jeremias monastery, also known as the *Ras al-Gisr*.⁴¹ There, Quibell⁴² found a quartzite stela inscribed for Amenhotep Huy, which was still visible on the desert surface in 2003.⁴³ This location is in close proximity to the tomb of Ptahmose. Since the collections of the museum in Leiden and the Museo Egizio in Florence also share objects from the tomb of Ptahmose, it is not unlikely that both men cooperated in excavating that tomb as well.⁴⁴

Lepsius, who stayed at Saqqara for some time in 1843, does not mention the tomb of Ptahmose in his *Denkmäler*, nor did he record its location. The tombs of Iurokhy (LS 25), Iry (LS 26), Maya (LS 27), Raia (LS 28) and Hormin (LS 29) are indicated on his general map of

³⁴ See G.T. MARTIN 1991, p. 114-115, with fig. 76.

³⁵ D’Anastasi employed agents to buy antiquities from the inhabitants of Saqqara (DAWSON, UPHILL, BIERBRIER 2012, p. 19). According to Maarten Raven (personal communication), it is not clear whether d’Anastasi hired people to work on his behalf, or whether these agents were the same his contemporaries, such as Henry Salt (1780-1827: DAWSON, UPHILL, BIERBRIER 2012, p. 484-485) bought from.

³⁶ PM III², p. 714; DAWSON, UPHILL, BIERBRIER 2012, p. 19-20. For the early history of the Leiden collection, see: HALBERTSMA 2003. A second lot was sold to the British Museum in 1839, and a third was auctioned in Paris, 1857.

³⁷ HAYES 1938, p. 14.

³⁸ HAYES 1938, p. 12-16: both the museum in Leiden (ex-coll. d’Anastasi, sold to the Dutch government in 1828) and Florence (ex-coll. Di Nizzoli, sold to the Grand Duke Leopold II of Tuscany in 1824; in the collection of the Museo Archeologico at Florence since 1882) have objects from that tomb. For a list of monuments from the tomb of Amenhotep Huy, see: PM III², p. 702-703, 835, 836. Another share of Di Nizzoli’s collection was sold in 1831-1832 to the Bolognese art collector and painter Pelagio Palagi (1775-1860). A substantial part of that collection derived from the excavations conducted by Di Nizzoli and Sola at Saqqara, April-May 1825 (DARIS 2005, p. 57-74). This collection was merged with that of the Museum of the University of Bologna in 1881, and now forms the nucleus of the Egyptian department

of the Museo Civico Archeologico in Bologna (PICCHI 2011, p. 277-301). The first part of Di Nizzoli’s collection was sold to the Kunsthistorisches Museum Vienna, in 1821.

³⁹ NIZZOLI 1841, p. 371 (translation as quoted by HAYES 1938, p. 13). On Amalia Sola’s *Memorie*, see e.g. PERNIGOTTI 1991, p. 3-84; PERNIGOTTI 2013, p. 182-183; SPACKMAN 2005, p. 35-54; POPOFF 2009.

⁴⁰ HAYES 1938, p. 14.

⁴¹ Cf. QUIBELL 1908, p. 63.

⁴² QUIBELL 1912, pl. LXXXIV.

⁴³ GESSLER-LÖHR 2007a, p. 68 and n. 18 (observed in 1988 and reconfirmed by Maarten Raven in 2003).

⁴⁴ Or they could have exchanged finds from their respective “excavations” at Saqqara.

Saqqara.⁴⁵ If Lepsius had indeed visited the tomb of Ptahmose, he might have been able to make the connection with the pyramidion (III.6) he saw with Fernandez, and the “doorjambs” (I.9-10) he bought in Cairo for the Berlin Museum.⁴⁶

It is not until 1859 that the accessibility of the tomb is again confirmed by Devéria. His photograph shows that the tomb was preserved to a considerable height and that it still contained *in situ* reliefs. Mariette published the tomb quite summarily, giving only a transcription of the text on panel JE 4874 (I.2).⁴⁷ He also copied texts from a few other tombs that can with certainty be located in the same area: Horemheb, Iniua, Hormin and, years earlier, Mery-Neith.⁴⁸ A selection of objects from these tombs were sent to the Bulaq Museum, founded by Mariette in 1858 and opened in 1863. Statues CG 604 and 606 from the tomb of Khay were photographed *in situ* by Devéria in 1859, and, according to Borchardt (1925, p. 154-155, 155-156), were found in March of that year. The Ptahmose panels were probably removed at the same time. Mariette does not include them in his 1868 catalogue of the Bulaq Museum, although *a* (and probably the same) Ptahmose is mentioned: “À côté des tombeaux de Tounar-i, de Phtah-mès et d’autres fonctionnaires Memphites de la XIX^e dynastie, existent les ruines de l’édicule funéraire d’un autre personnage de rang plus élevé, nommé Hor-em-heb”.⁴⁹

Whatever happened to the tomb after 1859 is not known, and the same is true for its reliefs photographed by Devéria. That some tombs were accessible as late as the 1880s is confirmed by the find of newspaper fragments in the statue room of Horemheb’s tomb, years after Mariette

⁴⁵ LD Tafelwerke, I, pl. 33. At one point Lepsius’ expedition was attacked and robbed during the night by an armed gang that set fire to their camp (LEPSIUS 1853, p. 69-79). Schneider (2012, p. 25) argues that, under these circumstances, they may have left behind some antiquities they planned to send back to Berlin. During the excavation of the tomb of Iniua in 1993, a collection of fine reliefs were found as if they had been intentionally stored there, pending transportation. Two columns from that tomb did indeed make it to the Berlin Museum (nos. 1627-1628). However, *pace* Schneider, Lepsius worked at Saqqara several weeks instead of several days, and continued to work there after the incident (LEPSIUS 1853, p. 74-79).

⁴⁶ LD Text, I, p. 15 (pyramidion, present location unknown), p. 16 (two doorjambs, Berlin 1631-1632). It is noteworthy that on his map of Saqqara, Lepsius (LD Tafelwerke, I, pl. 33) indicates the location of LS 26 to the east of LS 27, while in the text (LD Text, I, 182) he describes its location as “somewhat north of tomb LS 27”. LS 26 is attested by the broken stela of Iry, the *ss m t hwt Wsr-mꜣ’-t-R’ stp[.n]-R’ m pr Imn*, “Scribe

in the temple of Ramesses II in the house of Amun” (*i.e.* Theban Ramesseum).

⁴⁷ MARIETTE 1872, p. 20, pl. 62d (prepared by Mariette 1870-1881, and posthumously published by G. MASPERO, 1889): “Les débris de ce personnage sont dispersés dans les différents musées : on en trouve à Florence, à Paris et à Londres, comme à Boulaq”. An undated photograph (probably late 1870s) produced by Félix Bonfils (1831-1885) and now in the collection of the Frank H. McClung Museum of the University of Tennessee (Bonfils photo no. 213; file no. egypt222; cat. no. 09/02/96) shows a plaster cast of panel JE 4875. The missing right-hand side is reconstructed and the photo has the caption: “Roi Aménophis – Égypte”. The photo is taken in the Egyptian Museum, at that time located at Bulaq (1858-1890; SALEH, SOUROUZIAN 1986, p. 10).

⁴⁸ Horemheb: MARIETTE 1872, p. 25-26, pl. 74, rediscovered by the EES-Leiden mission in 1975 (G.T. MARTIN 1989, p. 57-58, scenes [57] and [58], pl. 50, 56-57; entrance to statue room. These doorjambs were discovered *in situ*; Mariette made a sketch of one

doorjamb and simply duplicated it (G.T. MARTIN 1976, p. 11). De Rougé also copied these doorjambs: DE ROUGÉ 1877, pl. CVII-CVIII; HARI 1964, pl. XIV (“Caire”). No Devéria photographs of the tomb of Horemheb have yet been identified; Iniua: MARIETTE 1872, p. 18, pl. 57 [a] (stela Cairo JE 10079), see now: SCHNEIDER 2012, scene [7], p. 71-73, fig. III.23; Hormin: MARIETTE 1872, p. 20, pl. 60 (JE 8374), see also: PM III², p. 664-665; Mery-Neith: MARIETTE 1889, p. 449 (tomb H9; relief fragments found amidst the tombs located south of the great pyramid, Saqqara November 30th, 1850), rediscovered by the Leiden-mission in 2001; see now: RAVEN, VAN WALSEM 2014, scenes [21-22] and [83]. Note that the name of Mery-Neith in his tomb is written as Mer-Neith, Mery-Neith, Meryty-Neith, and Mer-Neithy, later changed to Mery-re—a change that was subsequently reversed (RAVEN *et al.* 2001-2, p. 79-82).

⁴⁹ MARIETTE 1868, p. 281: 905 à 908 (Horemheb). For *Tounar-i* (Tjuneroy), see: PM III², p. 666-667 (as Tenry); MARIETTE 1872, p. 19, pl. 57b, 58.

had been working there.⁵⁰ A scenario similar to that in the nearby tomb of Maya is possible. There, the south reveal of the doorway between the statue room and inner court contained relief decoration, which was copied by the Lepsius expedition in 1843.⁵¹ Only part of that scene was rediscovered in 1987-1988, smashed to pieces.⁵² It is also possible that the Ptahmose relief was removed from the wall after 1859, to form part of a (private) collection where it has since remained unnoticed.⁵³

The Saqqara Tomb of Ptahmose

Objects Attributed to his Tomb

In the course of the first half of the 19th c. a number of statues, reliefs and pillars from the Memphite tomb of Ptahmose entered European public and private collections. A fair number of publications have since been devoted to individual objects. Lists of his monuments were published by Porter and Moss (PM III p. 192-193; PM III², p. 713-715), and Kitchen (*KRI* III, p. 171-180; *KRI* VII, p. 112-113, 180). Berlandini (1982a), Málek (1987), Van Dijk (1989), Franke (1993) and Greco (2011), added and/or rejected further attributions. All *disiecta membra* identified to date are presented below as an updated list. For a more comprehensive description of the individual objects the reader is referred to the publications cited. Table 4 gives an overview of the titles of Ptahmose collected from these monuments.

● I. Reliefs

- I.1 Cairo, Egyptian Museum JE 4873, TN 14.6.24.28 (55 × 42 cm).
- I.2 Cairo, Egyptian Museum JE 4874, TN 14.6.24.27 (62 × 47 cm).
- I.3 Cairo, Egyptian Museum JE 4875, TN 14.6.24.30 (62 × 27 cm).⁵⁴

Three limestone panels with relief decoration and texts. All depict the tomb owner seated in front of an offering table. The panel visible on the right-hand doorjamb in the Devéria photograph is not in Cairo.

⁵⁰ Maarten Raven, personal communication. Note that no tomb of the New Kingdom in the area south of the Unas causeway is indicated by name on the map of De Morgan (1897). Only nameless structures of New Kingdom date are indicated.

⁵¹ LD III, pl. 240a.

⁵² LD III, pl. 240a; G.T. MARTIN 2012, scene [30], p. 30-31, pl. 24-25, 90 [1].

⁵³ I thank Geoffrey Martin for checking his records of photographs and line drawings of Saqqara New Kingdom material held in museum collections. Unfortunately none could be identified as the Devéria relief.

⁵⁴ MARIETTE 1872, pl. 62 [d]; BERLANDINI 1982, p. 94-97 (with further references); *KRI* III, p. 171-172.

Note that the sequential order of *Temporary Numbers* omits TN 14.6.24.29, a relief from the nearby tomb of Iniua: PM III², p. 707 (as Nia); SCHNEIDER 2012, p. 86 [19], fig. III.34, pl. IX. Also relief Cairo TN 25.6.24.6 of Ptahmose (see I.7, below) is followed by a block of Iniua, TN 24.6.24.7 (SCHNEIDER 2012, p. 90 [22a], fig. III.37), which suggests that Mariette simultaneously worked in the tombs of Ptahmose and Iniua. Preceding the Ptahmose panels in the *Journal d'Entrée* numbering is JE 4872

(TN 12.6.24.11), a block in raised relief depicting a group of dancing men, and women playing the tambourine: G.T. MARTIN 1995, p. 6 [3]; PM III², p. 754; MASPERO 1914, p. 155 [562]; WRZESZINSKI 1923, p. 419. Provenance: Saqqara, "temple de Kha'i" (after a subsidiary figure, the sS [n] Imn zai); 50 × 105 cm (h × w). According to SALEH, SOUROUZIAN 1986, Cat. 214, and SULLIVAN 2002, the relief was found reused in the Serapeum, 1859. See also: Devéria Squeezes, 6170A, 13, 13bis, 18.

- I.4 Florence, Museo Egizio 2557 (74 × 139 cm).⁵⁵
A limestone revetment block with relief decoration in two registers. Only the lower part of the upper register is preserved. The tomb owner and his wife (partly preserved) are each depicted seated (left side) with male and female offering bearers approaching them from the right. All texts are carved in sunk relief, except for the text identifying a daughter in the lower right corner of the lower register (Inehyt, raised relief).
- I.5 Leiden, Rijksmuseum van Oudheden AP 54 (128 × 100 × 20 cm).⁵⁶
This limestone relief contains the fragments of two registers. Van Dijk⁵⁷ demonstrated a join with relief Liebieghaus IN 1643 (see below, I.6), and pointed to a connection with Book of the Dead chapter 71 on account of the vignettes depicted on both blocks. The upper register is divided into three scenes: part of a scene that includes Inehyt standing, hands raised in adoration and standing behind Ptahmose; Ptahmose kneeling in adoration in front of a seated god Ra; and a Hathor cow in a bark. The lower register is also divided into three scenes: Ptahmose kneeling in adoration; Ptahmose standing in adoration before Ra; and the tomb owner and his wife seated on a chair. Five of their children are depicted sitting behind them, divided over two sub-registers.
- I.6 Frankfurt, Liebieghaus IN 1643 (103 × 67 × 5 cm).⁵⁸
The right-hand side of this block joins Leiden AP 54 (I.5), and Franke suggested that at the top it joins with Cairo TN 25.6.24.6 (I.7).⁵⁹ The block contains three scenes, two of which continue on Leiden AP 54. In the upper register Ptahmose (and Inehyt) are standing in front of a pile of offerings, adoring a god (probably Osiris). The lower-right scene depicts Ra-Horakhti opposite a kneeling representation of Ptahmose (on Leiden AP 54). On the left side Ptahmose stands in adoration, in front of an enshrined and standing figure (statue) of Osiris.
- I.7 Cairo, Egyptian Museum TN 25.6.24.6 (59 × 76 cm).⁶⁰
This fragment may join Liebieghaus IN 1643. Ptahmose is seated on the left (monkey underneath the chair), overseeing activities in three sub-registers: bringing and preparing of fish (upper registers), and bringing and administering birds (lower register). Due to their similar subject, it is possible that this fragment was located near the “Mur Rhoné” (I.11).⁶¹
- I.8 Nasher Museum of Art at Duke University, cat. no. 95 (44 × 33 × 8,9 cm).⁶²
Limestone relief fragment with the head of Ptahmose, five columns of text in raised relief and a single line of text in sunk relief.

⁵⁵ BEREND 1882, p. 62-63, pl. 8 (as D. 18); PM III², p. 714; *KRI* III, p. 172; GRECO 2011b, fig. 5.

⁵⁶ BOESER 1911, p. 8, no. 4e, pl. XXX; *KRI* III, p. 176-178; VAN DIJK 1989, p. 47-54; FRANKE 1993, p. 159-172, fig. 37,2; GRECO 2011b, fig. 2. The relief, together with the four pillars Leiden AP 51, arrived in Leiden in 1829 (ex-coll. d'Anastasi, 1828).

⁵⁷ VAN DIJK 1989, p. 47-54.

⁵⁸ MÁLEK 1987, p. 132; VAN DIJK 1989, p. 47-54; FRANKE 1993, p. 159-172; GRECO 2011b, p. 197-198, fig. 6-7.

⁵⁹ FRANKE 1993.

⁶⁰ BERLANDINI 1982, p. 97-98; FRANKE 1993, p. 171-172; GRECO 2011b, p. 198, fig. 6-7. For a similar scene from the tomb of the Chief steward of Memphis, Iniua, see: SCHNEIDER 2012, fig. III.38 [22b] (Cairo TN 3.7.24.13; north wall of sanctuary); and the Overseer of the treasury, Maya: G.T. MARTIN 2012, scene

[37] and [38], pl. 29 (Cairo JE 4327a-e; north wall of inner courtyard).

⁶¹ BERLANDINI 1982, p. 93.

⁶² CAPART 1940, p. 249-250; BORCHARDT 1931, pl. 2 [12]; BERLANDINI 1982, p. 97-98 (“Fragment de paroi Berlin n° inconnu”); *KRI* III, p. 180 (“Slab [in trade], Saqqara”). For the modern history of this relief and a reconsideration of text and image, see STARING 2014.

- I.9-10 Berlin, Ägyptisches Museum 1631 (150 × 49 cm) and 1632 (201 × 49 cm).⁶³
Bought by Lepsius in 1842 from the antiquities dealer Solomon Fernandez in Cairo and subsequently transferred to the Berlin Museum.⁶⁴ These “doorjambs” are said to have been found together with the pyramidion presented here as III.6.
- I.11 “Mur Rhoné” (± 161,7 × 74,8 × 13,1 cm) (fig. 4)
Five adjoining relief decorated limestone revetment blocks, photographed *in situ* by Devéria (1859); present location unknown.⁶⁵ For a discussion of these reliefs, see below.
- I.12 “Block from Giza” (dimensions unknown).⁶⁶
This block was found by Lepsius in 1842-1843, built into an “Arabic” tomb in Gizeh. Unfortunately, Lepsius gives only a transcription of one line of text. No additional information is provided. Málek was the first to attribute this block to the corpus of Ptahmose. The title attested on the block bears close resemblance to that preserved on statue BM 1119 (II.6) and on Devéria photograph I.17D.
- I.13-17 Devéria doorway
Doorjambs (front and thickness) and reveal photographed by Devéria *in situ*, 1859; now lost. See discussion below.
- I.18 *In situ* (left block: ± 70 × 169 cm)
At least two relief decorated limestone revetment blocks were found *in situ* during the recent excavation of the tomb by the Cairo University mission in 2010. The tomb has not been published yet, but the press release on the discovery included the photograph of two adjoining *in situ* relief decorated revetment blocks, positioned on an east wall.⁶⁷ Only the left block is fully visible. To the left side of that block is a doorway. The scene itself is bordered by a block frieze and to the left-hand side two columns (originally three) of text are visible, both ending with the tomb owner’s name. The wall contains an undecorated dado of approximately 30 cm, and the scene and dado are separated by three superimposed lines, coloured red and yellow. The main scene depicts at least three papyrus boats each containing three men holding sticks or paddles. This representation resembles Old Kingdom mastaba scenes of boatmen in a tilting match.⁶⁸

● II. Statues

- II.1 Walters Art Museum 22.106 (132 × 45,1 × 87,8 cm).⁶⁹
A seated statue of Inehyt, the Songstress of the Lady of the Sycamore, wife of Ptahmose.

⁶³ LD Text, I, p. 16; PM III², p. 714; KR/III, p. 180. Text of 1631: ROEDER 1924, II, p. 217.

⁶⁴ Jewish antiquities dealer in Cairo (fl. 1830-1860) who mainly traded in antiquities he had found at Saqqara. DAWSON, UPHILL, BIERBRIER 2012, p. 190.

⁶⁵ First published by BERLANDINI 1982, p. 86-92, fig. 1, pl. VII; also KRI VII, p. 112; HOFMANN 2004, p. 145 and fig. 168. The dimensions are calculated

with the aid of the mudbricks visible behind the limestone slabs. Mudbricks of this period at Saqqara have a length of approximately 33 cm (cf. RAVEN 2005, p. 11; outer courtyard of Raia, early D. 19). BERLANDINI 1982, p. 86, reconstructs 165 × 75 × 13 cm.

⁶⁶ LD Text, I, p. 126 [8]; MÁLEK 1981, p. 157, with n. 13; MÁLEK 1987, p. 133. In PM III², p. 310, the block is designated “probably Saite”.

⁶⁷ Press release: “Discovery of the tomb of Ptahmes”, accessed 11.04.2014, <http://www.drhawass.com/blog/press-release-discovery-tomb-ptahmes>.

⁶⁸ For a study of this subject in tombs of the Old to Middle Kingdom, see HERB 2001.

⁶⁹ STEINDORFF 1946, p. 40, pl. XXI [106], CXII [106]; STEINDORFF 1942, p. 11-13, fig. 1, 3, 5; KRI VII, p. 113; MÁLEK 1987, p. 119-120. STEINDORFF

II.2 Matsuoka Museum of Art, Tokyo, no. 568 (121,9 × 45,7 × 79,2 cm).⁷⁰

A seated statue of Inehyt, almost identical to Walters Art Museum 22.106.

II.3-4 Rijksmuseum van Oudheden, Leiden, AST 7 and AST 8 (138 × 55 × 99 cm; 142 × 47,5 × 90 cm).⁷¹

The museum in Leiden has two near-identical seated statues of Ptahmose. These no doubt formed pairs with the seated statues of his wife, Inehyt (nos. II.1 and II.2).⁷²

II.5 Cairo, Egyptian Museum JE 41532 (h. 40 cm).⁷³

Dyad fragment of Ptahmose and Inehyt, seated. Found by James Quibell during excavations in the ruins of the Apa Jeremias monastery at Saqqara.

(1942, p. 9-11) notes similarities with the statue of Meryt, wife of Maya: Leiden AST 2 (BOESER 1912, pl. V) and the double statue BM EA 36, recently identified as General Horemheb and his wife (VAN WALSEM, RAVEN 2011, p. 375-383). The statues' (II.1-2) earliest appearance can be traced back to the collection of Count Jules de Castellane. His collection, formed around 1825, was accommodated in the Château des Ayalades, Marseilles (WALDSTEIN 1926, p. 190-191). According to Steindorff (1942), the two statues may have been brought to France in 1820 by the Frenchman Saulnier (cf. DAWSON, UPHILL, BIERBRIER 2012, p. 487) as part of a large collection which he sold there. Alternatively, they may have been acquired in Egypt by Jean François Champollion, 1828-1829. He was on very good terms with d'Anastasi (STEINDORFF 1942, p. 11). While Steindorff revised this option in view of information provided to him by B.V. Bothmer—who proposes that the statues were taken to France by officers of the Napoleonic expedition (STEINDORFF 1947, p. 58)—the Champollion-d'Anastasi connection, I would say, remains likely. After all, numerous monuments from the tomb of Ptahmose were acquired by d'Anastasi. After Count Jules de Castellane died (1861), the Château des Ayalades and its contents passed to his eldest daughter, the Marquise d'Estournel (WALDSTEIN 1926, p. 190-191). When she eventually passed away, her relatives sold both the Château and its contents. The antiquities were bought by a number of local dealers. There is no complete record of where these all went to. In

1917 Jacques Seligman from Paris purchased the Baltimore statue from an unnamed Marseilles dealer (<http://art.thewalters.org/detail/22976/seated-statue-of-nehyt> accessed 21.03.2013). It subsequently changed ownership several times. From 1917-1921 it was in the possession of Henri Daguerre and Joseph Brummer. Brummer probably transported the statue to the United States, where it was eventually sold in 1922 to Samuel Untermeyer from New York. In 1925 it finally entered the private collection of Henry Walters from Baltimore and, by bequest, came to be part of the Walters Art Gallery (now: Museum) in 1931.

⁷⁰ STEINDORFF 1946, p. 11, 14, fig. 4, 6; CHRISTIE'S 1976, no. 117 with pl. 29; *KRI* III, p. 179; MÁLEK 1987, p. 119-120; WADA 1999. With the sale of the Castellane collection in 1917, the statues of Inehyt got separated. The current statue was acquired for the Reverend Theodore Pitcairn Collection in Bryn Athyn, Pennsylvania (PM III², p. 715; STEINDORFF 1942, p. 11), and later bought by Sejiro Matsuoka (Japan) for his private collection. In 1975 he founded the Matsuoka Museum of Art, which in 2000 moved to the present location at Shirokane, Tokyo. I am grateful to Mr. Osamu Matsuoka of the Matsuoka Museum of Art for providing me with information on this statue. According to Wada (1999), the statues of Inehyt were purchased by d'Anastasi in the early 1820s and then by Champollion in 1828-1829 in Egypt.

⁷¹ AST 7: BOESER 1911, p. 8-9, pl. 31; *KRI* III, p. 179, GRECO 2011b, fig. 3;

AST 8: BOESER 1911, p. 9, pl. 32; *KRI* III, p. 179; MÁLEK 1987, p. 118; GRECO 2011b, fig. 4.

⁷² The only parallel for a pair of life-sized seated private statues of a husband and wife from New Kingdom Saqqara is presented by the Overseer of the Treasury Maya (Leiden AST 1) and his wife Meryt (Leiden AST 2), both of which are actually over life-sized. For an overview of private funerary statuary from Saqqara, see MÁLEK 1987, p. 117-127. The number of six from the tomb of Ptahmose is surpassed only by Horemheb ("at least eight", MÁLEK 1987, p. 127; now also VAN WALSEM, RAVEN 2011, p. 375: "at least one triad, four dyads (recently identified: BM EA 36, ex-coll. d'Anastasi 1839), two standing statues, one of which must have had a pendant, a quartzite statue, a kneeling statue, and a statue of Mudnodjmet", *i.e.* at least 11 statues). There are various reasons to associate anonymous dyad Leiden AST 4 (BOESER 1912, p. 6 [14], pl. VIII; ex-coll. d'Anastasi 1828) and kneeling statue Leiden L.X.2 (BOESER 1912, p. 11 [25], pl. XII; SCHNEIDER 1996, 76; ex-coll. De Lescluze) with the Horemheb corpus as well (cf. VAN WALSEM, RAVEN 2011, p. 378-380). Only four statues are thus far known for Maya, see: G.T. MARTIN 2012, pl. 116-130. However, see G.T. MARTIN 2012, scene [43], pl. 32-33, for the dragging to the tomb of several statues represented in wall decoration. The naophorous and standing statues have not been found during excavation.

⁷³ QUIBELL 1912, p. 146, pl. LXXXVI [1, 2]; *KRI* III, p. 180; MÁLEK 1987, p. 119.

II.6 London, British Museum EA III9 (35,5 × 34,5 × 21 cm).⁷⁴

Naophorous, kneeling statue, fragment of lower part. Ptahmose holds a naos with the god Ptah. The statue was found by Petrie at Saqqara, 1881-1882.

● III. Architectural Elements

III.1-4 Leiden, Rijksmuseum van Oudheden AP 51a-d (215/230 × 37/40 cm).⁷⁵

Four *djed*-pillars. In his discussion on Memphite *djed*-pillars, Van Dijk, argued that Ptahmose's tomb must have contained at least six such pillars.⁷⁶ Three pillars (*b-d*) belong to the so-called "southern" type and one (*a*) to the "northern", assuming that the image of the adoring tomb owner faces the central east-west axis of the tomb.

III.5 Cairo, Egyptian Museum 40.000 (h. 225 cm).⁷⁷

Papyriform column found reused by Quibell in the monastery of Apa Jeremias. The column contains text on the abacus and has a panel showing the kneeling figure of Ptahmose, adoring, with seven columns of text.

III.6 Pyramidion (present location and dimensions unknown).

When Lepsius bought the two doorjambs (I.9-10) in 1842, he also noticed a pyramidion in the possession of Fernandez. Lepsius briefly described the object, indicating that it had the same provenance as the two doorjambs, and added a transcription of the text. He did not indicate whether or not he bought the object for the Berlin Museum, which added to later confusion.⁷⁸ The inscription (two titles) published by Lepsius is significant for dating Ptahmose, as it mentions Memphite temples of Seti I and Ramesses II.⁷⁹

● IV. *Stelae*

IV.1 "Stela from Kafr el-Haram" (present location and dimensions unknown).

In his notebook, Hans Ostenfeldt Lange (1863-1943)⁸⁰ notes to have seen a 19th Dynasty stela of the (←) , *Im.y-r pr wr n(.y) Pth Pth-ms*, "Chief steward of Ptah, Ptahmose", with a dealer in Kafr el-Haram, 1899.⁸¹ There can be little doubt that this is

⁷⁴ WALLIS BUDGE 1909, p. 127 [450], described the statue as that of a "royal scribe, chief steward of Ptah, and prefect of the House of the Ka of Ptah at Memphis", 18th Dynasty, provenance Memphis. HELCK (1958, p. 225, n. 14) included the statue in the corpus of monuments attributed to "our" Ptahmose. Later, MÁLEK (1987, p. 117-137) dedicated an article to this statue and thoroughly studied its texts, with special emphasis on the official's titles (for an earlier note on the statue, see MÁLEK 1981, p. 157). A photograph preserved in the Griffith Institute archives at Oxford, taken by Petrie in 1881-1882, shows the statue lying in the sand. A handwritten comment added by Petrie described it as a "shrine of Ptah dedicated by Ptah-mes an architect. Sakkarā"

(MÁLEK 1987, p. 127). Therefore, the statue must be regarded as a tomb-statue and not as a temple-statue. For a brief overview of naophorous tomb-statues from Saqqara, see MÁLEK 1987, p. 121-122, and VAN DIJK 1993, p. 113-132.

⁷⁵ BOESER 1911, p. 7-8, pl. 26-29; PM III², p. 714; *KRI* III, p. 173-176; VAN DIJK 1993, p. 151-152; GRECO 2011b, fig. 1. Ancient Egyptian graffiti are incised on the pillars' surfaces: STARING 2011, p. 152-154, fig. 7-8. Two of these graffiti find a direct parallel in the tomb of Horemheb, north jamb and north reveal of pylon entrance. Compare: STARING 2011, p. 152-153, fig. 6-7; RAVEN, VAN WALSEM 2011, fig. 1.8, Gr. 43, 42: a royal head with white crown and a cynocephalus, respectively.

⁷⁶ VAN DIJK 1993, p. 152.

⁷⁷ QUIBELL 1909, p. 15; BERLANDINI 1982, p. 99-101, pl. XII; *KRI* III, p. 179. PM III², p. 715 has: "probably not in Cairo Mus."; however, see: G. T. MARTIN 1995, p. 11, no. 39.

⁷⁸ *LD* Text, I, p. 15 [below]; *KRI* III, p. 179; RAMMANT-PEETERS 1983, p. 92 [Doc. 93].

⁷⁹ For a discussion on these titles, see *infra*.

⁸⁰ DAWSON, UPHILL, BIERBRIER 2012, p. 308.

⁸¹ H.O. Lange Notebook 1899/1900, p. 41. The Notebook is part of the Egyptological Archives, The Papyrus Carlsberg Collection of the University of Copenhagen. I owe this reference to Maarten Raven and thank Dr. Kim Ryholt for sending me a scan of the relevant page of the Notebook.

front of a seated Ptah; in the middle section both present a libation to the Apis bull; and in the lower section a male figure stands in front of an offering table with three seated females behind him.

While the stela itself does not mention any date, it has generally been used to position Ptahmose around year 30 of Ramesses II. Like the *shabti* (VII.2, below) found in the Serapeum, this stela identifies its dedicator as *sš nsu.t* and *imy-r pr*; similar to statues Leiden AST 7-8 (II.3-4). The orthography of the name “Inehyt” differs from the other monuments,⁹¹ reading $\left\{ \begin{array}{l} \text{𓆎} \\ \text{𓆏} \\ \text{𓆐} \\ \text{𓆑} \\ \text{𓆒} \end{array} \right\}$, *Īw-hb.t*, although the *b* could also be read as a very slender $\left\{ \begin{array}{l} \text{𓆎} \\ \text{𓆏} \end{array} \right\}$, *nht*, and the horizontal line above the seated woman determinative might represent the *n*, resulting in a more common variation for the name *Nh.t*.⁹² The names of the figures in the lower section of the stela (their children?) are not attested in any other document. The garment worn by Ptahmose resembles that worn by him on the pillars Leiden AP 51, but the execution is different.

VII.2 Paris, Louvre SH 213 (20,7 × 5,5 cm).⁹³

Shabti found in the Serapeum. Inscribed with the titles *sš nsu.t* and *imy-r pr*. Another 19th Dynasty Mayor, Amenhotep Huy, also dedicated a *shabti* in the Serapeum. He is identified as *ḥ3.ty-ᶜ n(.y) Mn-nfr*.⁹⁴ This raises the question why Ptahmose identified himself “only” as Steward. It is possible that he donated the *shabti* and stela (VII.2) at an early stage of his career. Similarly, he is titled Royal scribe and/or Steward on the statues (II.3-4), stela (IV.1) and sarcophagus fragment (V.1).

● Attribution Uncertain

- I. PM VIII/2, p. 582 lists the headless steatite statue of a *Mayor Ptahmosi*, of unknown provenance, temp. Ramesses II. The statuette, a kneeling and headless male figure presumably holding a naos in front of him, was auctioned at Christie’s London, 1992.⁹⁵ The statue measures 11,7 cm (h) and has one column of text inscribed on the dorsal pillar. According to the description provided in the sale catalogue it reads: “/// to the Ka of the Hereditary Count, Ptah-mose, true [of voice]”. The statue is now in a private collection and only one photograph, *en profil*, is available. The title Hereditary count should be understood as a translation for *ḥ3.ty-ᶜ*. The kneeling figure wears an ankle-length pleated garment identical to that of BM 1119 (II.6). The title, date, and garment all meet the criteria to include it in the current corpus. A detailed study of the object should eventually be decisive.

⁹¹ There are quite a number of variations for the spelling of this name, see ANDREWS 1978, p. 89; in the tomb of Nebsumenu (TT 183), no less than eight different spellings are recorded for his sister-in-law. According to Andrews, who lists a total of fifteen different spellings, these should all be considered variations of the name *Nhy.t*, or “Sycamore” (cf. *PN* I, p. 206 [26]). Therefore, a variant spelling of this name cannot solely be used to reject an identification. The name of Ptahmose

has likewise been written with three varying forms in the current corpus of monuments.

⁹² Cf. *KRI* II, p. 372-373. Compare: ANDREWS 1978, p. 89; see also: *PN* I, 206 [22], *Nh.t*, “die Sykomore”.

⁹³ MARIETTE 1857, pl. 13 (“Apis III”); BERLANDINI 1982, p. 101, pl. XIII; *KRI* II, p. 372; *KRI* VII, p. 113; AUBERT, AUBERT 1974, p. 86. South of Gizeh extrasepulchral *shabtis* have been found at different locations, including in the Serapeum. “Caveau no. 8” consisted

of two rooms, the second of which contained sarcophagi of the Apis bulls that died in years 16 and 30 of Ramesses II. The *shabti* inscribed for Ptahmose is described as found against the second sarcophagus (AUBERT 1974, p. 86; SCHNEIDER 1977, I, p. 279, 282). ⁹⁴ *KRI* II, p. 369; SCHNEIDER 1977, no. 3.2.1.53, pl. 103.

⁹⁵ CHRISTIE’S 1992, p. 71 [150]. I thank Victoria Hearn of Christie’s Antiquities Department, London, for sending me a digital copy of the catalogue.

2. Another unprovenanced, granite cubic statue (h: 31 cm) in the collection of the musée archéologique in Strasbourg, II. 987. O. 146 (M.A.D. LXXI.97), has a single vertical line of text on the front: *ḥꜣt.y-ꜥ Pth-ms(.w)*.⁹⁶ On stylistic grounds, however, Schulz dated the statue to Amenhotep II-Thutmose IV.⁹⁷
- Previously Attributed to Ptahmose, but Now Rejected
 1. The identification of the statue Leiden AST 23 was proposed by Schiaparelli, initially accepted in Leiden, but recently rejected on account of the titles.⁹⁸
 2. Relief Munich GL. 298 was listed by PM III, p. 193, but actually forms part of the Memphite tomb of the Chief goldsmith Amenemone.⁹⁹
 3. Cubic statue fragment Cairo CG 642 of Ptahmose. His titles, Royal scribe of the double treasury, Overseer of cattle of Amun, and Royal scribe [lacuna] of the Lord of the Two Lands, exclude an identification with the Mayor.¹⁰⁰

Devéria Doorway: Translation of Texts¹⁰¹

Doorway, North Reveal (I.13)



[1] // iw p r (?)^a [2] dd mdw h(z)^b iy.t(i) m htp r imnt.t hnm.t(w) m hw.t=k^d n.t nbh is.t=k n.t [3] d.t qrs.t(w)=k im m(-ht) iw nfr iw=k m hs.wt nsw.t r htp m 'nh-tz.wy^e.

[1] // ? [2] *Recitation: Ha! Welcome (in peace) to the west (i.e. necropolis), may you unite with your placel/house of eternity, your tomb of [3] everlastingness, may you be buried in it after an old age, you being in the royal favour to rest in Ankhtawy.*

⁹⁶ PM VIII/2, p. 619 (801-643-555): formerly in the P. Nelson collection and auctioned at Sotheby's in 1931.

⁹⁷ SCHULZ 1992, I, p. 511 [312], II, pl. 133[c]. It is not certain whether *ḥꜣt.y-ꜥ* should be understood as an honorific or rank title. Compare the early 18th Dynasty cubic statue of the Mayor of Memphis *Hw-m'cy*, who is identified as *ḥꜣt.y-ꜥ n(.y) Mn-nfr* (Paris, Louvre E 5336: SCHULZ 1992, I, p. 449 [267], II, pl. 118[a]).

⁹⁸ Ptahmose, God's Father of Ptah in the temple of Ptah: PM III², p. 728;

BOESER 1912, p. 10-11 [24]; SCHIAPARELLI 1887, p. 326; SCHNEIDER, RAVEN 1981, p. 99; GRECO 2011a; GRECO 2011b. See also: KRI III, p. 416-417; GESSLER-LÖHR 2012, p. 186, with n. 162.

⁹⁹ KEIMER 1929, p. 84, pl. II; OCKINGA 2004, scene [6A-B], pl. 12-13, 53, 60-61.

¹⁰⁰ BORCHARDT 1925, p. 188; PM III², p. 667; KRI III, p. 172-173; MÁLEK 1987, p. 132; HELCK 1958, p. 394 (as the father of the Overseer of the Double Granary, Ptahmose). Previous identification rejected by BOHLEKE 1991, p. 314-316. Bohleke likewise rejects Berlandini's

tentative suggestion (BERLANDINI 1982, p. 101 n. 2) that the shabtis of an Overseer of the double granary, Ptahmose (Cairo CG 46564) and Royal scribe and Overseer of the double granary, Ptahmose (Cairo CG 47181) can be related to the Mayor of Memphis.

¹⁰¹ The texts are numbered in continuation of the list of monuments attributed to Ptahmose (*supra*). For the proposed orientation of the doorway, see section "Location of the Devéria doorway", below.

Doorway, North Jamb, Thickness (I.14)



- [1] */// [ns/r] s[h]rr(f)^f m h_w.t-k₃-Pth sr hr^g[.y-tp m] šny.t^h w^c mn_h n ntr nfrⁱ sš nsw.t im.y-r pr wr m [pr Pth /// Pth-ms m₃^c-hrw nb im₃h].*

[1] */// [tongue/mouth] that appeases in Hutkaptah (i.e. Memphis), Nobleman, Chief [amongst] the courtiers, Unique and excellent one of the Perfect God (i.e. the king), Royal scribe, Chief steward in [the house of Pth /// Pthmose, true of voice, possessor of reverence].*

Doorway, North Jamb, East Side (I.15)

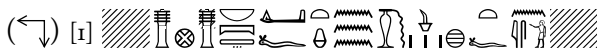

- [1] *[h_{tp} d_i nsw.t^k Wsir nb] Ddw^l nb p.t t₃^m d_iz^ft mw qb_h.w sntrⁿ hft n_is[=f rn=k^o /// n Wsir /// Pth-ms m₃^c-hrw nb im₃h].*

[1] *[An offering which the king gives to Osiris, Lord of] Busiris, Lord of heaven (and) earth, may he grant bread, water, libation and incense when he calls [your name /// for the Osiris /// Pthmose, true of voice, possessor of reverence].*

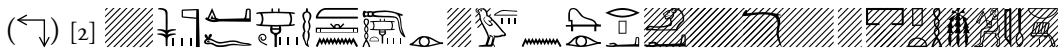

- [2] *[h_{tp} d_i nsw.t ///] nsw ntr.w^p d_iz^ft₃w ndm n m_hy.t iri ?^a n Wsir (i)r(.y-)p^c(.t) h₃.ty-^c im.y-r /// m pr Pth Pth-ms m₃^c-hrw nb im₃h.*

[2] *[An offering which the king gives to ///], king of the gods, may he grant a sweet breeze of the north wind made? for the Osiris, Noble and count, Steward /// in the house of [Pth, Pthmose, true of voice, possessor of reverence].*



- [3] *[h_{tp} d_i nsw.t /// d]s^fr^r d_iz^fh_{tp} b₃(=k) m is d.t sp sn.w n Wsir (i)r(.y-)p^c(.t) h₃.ty-^c sš nsw.t im.y-r m₃^c m pr-Pth Pth-ms m₃^c-hrw nb im₃h.*

[3] */// [An offering which the king gives to ///, ///] himself, may he grant that (your) ba will rest in (its) tomb forever and ever for the Osiris, Noble and count, Overseer of the troops in the house of Pth, Pthmose, true of voice, possessor of reverence.*

(↙) [4] 

[4] [h_{tp} d_i nsw.t Ws_{ir} /// h_kz] d.t^s d_i-f^c k p_{ri}(.t) m r-st_w h_{tp} m zbdw n Ws_{ir} (i)r(.y-p)^c(.t) h_z.ty-^c s^s nsw.t im.y-r šnw.ty n(.y) nb m_z^c.t^t Pth-ms m_z^c-hrw nb im_zh.

[4] [An offering which the king gives to Osiris /// ruler of] everlastingness, may he grant to enter and leave in Rosetau (and) to rest in Abydos for the Osiris, Noble and count, Royal scribe, Overseer of the granaries of the Lord of Truth (i.e. Ptah), Ptahmose, true of voice, possessor reverence.

Doorway, North Jamb, East Side, Panel (I.16)

(↙) [1] 

[1] /// [2] s^s nsw.t im.y-r pr [3] m [pr Pth] [4] [Pth-ms m_z^c-hrw].

[1] /// [2] Royal scribe, Steward [3] in the [house of Ptah] [4] [Ptahmose, true of voice].

Doorway, South Jamb, East Side (I.17)

(↘) [1] 

[1] [h_{tp} d_i nsw.t ///] iw_{nn}.t n(.y)t h_{sy}.w^a d_i-f^c z_h wsr m_z^c-hrw n Ws_{ir} (i)r(.y)-p^c(.t) h_z.ty-^c s^s nsw.t im.y-r pr n(.y) Pth Pth-ms m_z^c-hrw nb im_zh.

[1] [An offering which the king gives to ///] sanctuary/chapel of the praised/favourite/blessed one(s), may he grant a blessed state, power, and justification for the Osiris, the Noble and count, Royal scribe, Steward in the house of Ptah, Ptahmose, true of voice, possessor of reverence.

(↘) [2] 

[2] [h_{tp} d_i nsw.t ///] t_w.w hr nb^v d_i-f^c sm_w^w h.t m h_w.t skry^x n Ws_{ir} (i)r(.y)-p^c(.t) h_z.ty-^c im.y-r m_s^c m pr-Pth Pth-ms m_z^c-hrw nb im_zh.

[2] [An offering which the king gives to ///] lands(?) and all people, may he grant a partaking in the offerings in the Mansion of Sokar, for the Osiris, the Noble and count, Overseer of the troops in the house of Ptah, Ptahmose, true of voice, possessor of reverence.

(↘) [3] 

[3] [h_{tp} d_i nsw.t ///].t iw.ty rd_i hr-gs^y d_i-f^c ir(i) h_{pr}.w m Bnw^z n Ws_{ir} (i)r(.y)-p^c(.t) h_z.ty-^c im.y-r pr-h_d^{aa} n(.y) nb m_z^c.t Pth-ms m_z^c-hrw nb im_zh.

- g. Although this sign is damaged, it doubtlessly reads *hr*. Cf. AL-AYEDI 2006, p. 428 [I460]: *hry-tp sr.w*, “Chief nobleman”. Compare for a different spelling *KRI* III, p. 171,14 (JE 4873): *hry-tp wr m inb.w-hd*, “Great chief in Memphis”; cf. AL-AYEDI 2006, p. 425 [I447]: *hry-tp wr.w*, “Chief of chiefs”. The alternative reading of this sign as *tp* would allow for the reconstruction of the honorary title *sr tp.y m šny.t*, “First official among the courtiers” (cf. RAVEN 2005, p. 44 [70], pl. 74-75), or *sr tp.y m h3.t šny.t* (cf. *KRI* III, p. 94,6: *tp.y n.y [smr.w] m h3.t šny.t*); or Nobleman, head of the king’s courtiers, in parallel to e.g. relief Copenhagen, Ny Carlsberg Glyptotek ÆIN 714 of the General Amenemone: MARTIN 1987, pl. I [b]); and *sr tp.y m inb(.w)-hd*, statue of the Vizier Paser from the temple of Mentuhotep II at Luxor: Frankfurt, Liebieghaus 271a-d/Philadelphia, University Museum E.534; *KRI* III, p. 18,6-7; RAEDLER 2012, p. 122. According to Raedler, this epithet is only very rarely attested for members of the royal court.
For the terms *šn.wt* and *šny.t*, see RAEDLER 2006, p. 43; RAEDLER 2012, p. 124-129 (“Hofstaat / Hofleute”).
- h. The damaged area allows for the inclusion of another block of signs, enabling e.g. the reconstruction *sr hry-tp m šny.t nsw.t*, “Nobleman, greatest amongst the king’s courtiers”.
- i. Cf. TAYLOR 2001, p. 88 [799].
- j. It is difficult to ascertain the remaining length of this column. One could argue that it ran to approximately the same level as the baseline of the two standing figures on the adjacent reveal and that it concluded with *Pth-ms m3'-hrw nb im3h*. Such a reconstruction would allow for the inclusion of yet another title.
- k. The subject of the corresponding panel below, *i.e.* the tomb owner receiving offerings while seated at an offering table, justifies this reconstruction.
- l. Alternatively: *nsw Ddw*, “King of Busiris”, cf. Leiden AP 51b (BOESER 1911, pl. XXIX). *Ddw* could also be understood as part of an epithet of Wennefer, cf. ASSMANN 1991, p. 79 [Text 93], pl. 36: *Wnn-nfr hry-ib Ddw*, “Wennefer, who lives in Busiris”.
- m. This reading is not without difficulty. At first, one is inclined to read *nb t3.wy*. At closer inspection, the upper *t3*-sign appears to be more rectangular shaped than the lower sign. One may read: *nb pt t3* (cf. QUIBELL, HAYTER 1927, pl. 19: relief “A” from the tomb of Huy, as an epithet of Amun).
Alternatively, one could interpret the upper sign as *š*, reading *nb št3y* (*Wb* IV, p. 553), an abbreviation for commonly associated with Sokar (see below, x.).
- n. Cf. Ptahmose, Leiden AP 51b (BOESER 1911, pl. XXVI): Gardiner Sign-List W15 (*qbh*) is reversed.
- o. Cf. BARTA 1968, p. 132(c) [Bitte 212]: *di.f pri.t [hr] hrw hft nis šsp t mw t3w*, “Er möge das Hervorkommen auf die Stimme geben, wenn er ruft um Brot, Wasser und Luft zu empfangen”. The damaged area allows for a short continuation of this formula, before commencing with *n Wsir*. One might expect *nis=f* or perhaps even *nis=fm(=k)*. Another possibility is *nis m rn*, “(when) called by name” (HANNIG 2006, I, p. 1206 [= CT sp. 469, V398d]).

- p. *nsw ntr.w* is a common epithet for Amun-Re, but it is associated occasionally also with Ptah, cf. G.T. MARTIN 1985, p. 18 [xi], pl. 28 (pillar [D] from the tomb of the Chief guardian of the scribes of the Lord of the Two Lands, Amenmose): *nfr hr nsw ntr.w*, “[Ptah] beautiful of face, king of the gods”. On column Cairo 40.000 (III.5), the epithet is associated with Osiris-Wennefer (BERLANDINI 1982, p. 100-101 [c]). Which deity is addressed here is difficult to ascertain, since no trace remains of the preceding epithet. For more references, see LEITZ 2002, p. 333-336 (especially to Osiris).
- q. The reading of these signs is uncertain. The *w* could be understood as part of the name for the god Atum. Compare BARTA 1968, p. 215 [Bitte 79(a)]: (*di=sn*) *snsn=f t3w ndm n mh.yt pri m Itm.w*, “(Sie mögen geben), daß er den süßen Hauch des Nordwindes atme, der hervorkommt aus Atum”.
- r. The reading of the first sign is uncertain. It resembles —, enabling the following reconstructions:
 – *hpr ds=f*, “who came into being of himself”, epithet of Khepri (G.T. MARTIN 1989, p. 32 [9], pl. 23), Thoth (G.T. MARTIN 1989, p. 30 [7], pl. 21-22), or Atum-Horakhti (Leiden AP 54; KRI III, p. 177,6-7);
 – *wtt sw ms sw ds=f*, “who begot himself and gave birth to himself” (epithet of Re-Horakhti).
- s. Lacking indications for the first part of this epithet, alternative reconstructions with *d.t* are equally valid.
- t. See GOHARY 2009, p. 37: both Nebnefer and his son Mahu (tomb ST 218) were bearers of the same title.
- u. For *iwnn*, as a general term for “sacred place”, “shire”, “temple”, see: *Wb* I, p. 55 (“*Wohnung eines Gottes*”); SPENCER 1984, p. 99-103 (with references). The term is attested for the 18th and 19th Dynasty, and again for the Ptolemaic period. I have not been able to find a parallel for *iwnn.t n.t hsy.w*. J. Van Dijk (*personal communication*) points at the possibility that the “temple of the blessed” could be a reference to the statues of the deceased placed in temples or, as in the present context, tomb superstructures (cf. *Wb* III, p. 157, 1: *hst*, with determinative 𓆎), as “Bez. für die durch Stiftung ihrer Statue in den Tempel Ausgezeichneten”.
- v. Presumably this is an epithet of a deity mentioned in the offering formula; “god X who made the lands and all people” (suggestion B. Ockinga). It is not clear which deity is addressed here.
- w. Cf. BOESER 1911, pl. XXVIII, Leiden AP 51a.3: 𓆎 .
- x. See BROVARIKI 1984, col. 1064. For references to “Mansions of Sokar”, see e.g. HELCK 1960, p. 924 (I42) [II.a]: the *sm*-priest in the *hw.t-skr* Minmose (D. 19, temp. Ramesses II); PETRIE 1902, pl. 67 [4]: statue of Wennefer, *sem*-priest in the *hw.t-skr* (D. 19, temp. Seti I); and HAYES 1959, p. 158: on a statue of Thutmose date. According to PETRIE 1902, p. 46, the *hw.t-skr* was part of the temple of Seti I at Abydos, where, in Mariette’s *Salle T*, it is repeatedly mentioned on the temple walls. In the context of Saqqara, it is possible that the “Mansion of Sokar” can be identified with the *Shetayet*-shrine (see above, m.), the location of which is suggested in the area of Rosetau (EDWARDS 1986, p. 28-29). Rosetau, then, may refer to the vast desert stretching between Saqqara and Gizeh (ZIVIE-COCHE 1984,

col. 304-305). S.S. Abd el-Aal (2009, p. 5 and pl. 3b) suggested that this is the place where some New Kingdom chapels were dedicated during the New Kingdom (*i.e.* Kafr el-Gebel or Nazlet el-Batran, to the south of the Gizeh plateau). On the Kafr el-Gebel monument of his superior Tia, Iurudef is attested with his title *im.y-r k3.t n nb=f n r-st3.w*. That title does not recur in his funerary monument at Saqqara.

A related structure is the *pr-hnw*, from where the *Henu*-barque of Sokar was carried forth around the walls of Memphis during the annual Sokar-festival (KITCHEN 1977, p. 119-120), and the *hw.t-hnw* (e.g. BADAWI 1944, p. 193: mentioned on the sarcophagus of the Mayor Amenhotep Huy).

During the Ramesside period, various priests of the “Mansion of Sokar” in the “Mansion of Amenhotep III” (at Thebes) are known (GABALLA, KITCHEN 1969, p. 29; HELCK 1960, p. 101, no. 15a; KEES 1958, p. 142).



Pillar Leiden AP 51a of Ptahmose also contains a reference to a *hw.t Skry*: “Wennefer, Lord of the Sacred Territory. He who awakes safe, residing in the Mansion of Sokar”.

- y. I have found no parallel for this epithet. Similar, but of a later date, is *iw.ty-g3=f*, “Dessen Parteilichkeit es nicht gibt”, an epithet for Haroeris in the Graeco-Roman period: LEITZ 2002, p. 165.

For *rdi r-gs*, see: *Wb* II, p. 467: “parteiisch sein”.

- z. Compare Ptahmose pillar Leiden AP 51b.4 (BOESER 1911, pl. XXIX: ). The bird-sign has been variably read as *b'h* (abundance: “<Anubis> *di.f ir.t hpr.w b'h tp t3*”, “<Anubis> il donne de faire (ses) transformations, de bénéficier de l'abondance sur terre”: ZIVIE 2009, p. 63 [text 39], pl. 36); *ir.t hpr.w b'h tp t3*, “Gestaltungen anzunehmen, die die Erde erfüllen”: ASSMANN 1991, p. 79 [text 93], pl. 36; GESSLER-LÖHR 1997, p. 52, pl. 8 [I]: MMA 36.3.272, doorjamb of the Theban tomb of the Mayor of Memphis, Menkheper) or *Bnw* (“<Anubis> *ir(i).t hpr(.w) m Bnw*”, “<Anubis> transform into a Benu (Phoenix)”: VAN LEER 1938, p. 32, pl. XVII; 8***: APM 8852, Scribe Ta).

In the present context, with the presence of the preposition *m*, the second translation is preferred. For what may be the complete writing of this spell, compare the stela of the mid-18th Dynasty Overseer of cattle of Amun Hatiay from Saqqara: Florence 2593 (ex-coll. DI NIZZOLI 1824; BOSTICCO 1965, fig. 36): , *ir.t hpr(.w) m Bnw Šnty*, “to transform into a Benu and Shenti”, and the fragment of a jamb from Saqqara (G.T. MARTIN 1979, p. 44 [I36], pl. 39): [*ir(i).t hpr.w m*] *Bnw Šnty*. For *Šnty*, see *Wb* IV, p. 519: “als Vogel, in den sich die Seele des Toten verwandeln möchte” (BD 84). The transformation into a Benu refers to BD 83. The complete spell makes reference to BD chapters 83 and 84.

- aa. The “stroke” encompassed by the *pr*-sign is not convincingly long or short, and could be read as either  or as . The readings result in two rather different titles: Steward in the house of the Lord of Truth, or Overseer of the treasury of the Lord of Truth. The first option is attested on several objects of Ptahmose (*i.e.* I.17a, II.3, 5, II.3-4, VII.1-2), while the latter is not (nor is it known from other sources). However, the stroke appears to be too long not to resemble the *hd*-sign.

- bb. Cf. G.T. MARTIN 2001, p. 15 [Khay, 6] pl. 10.

As a final note on the text, one may refer to the “Ramesside orthography”.¹⁰² The squares of hieroglyphs on the doorjamb are crowded. This “aesthetic adjustment” in the spacing of signs, observable in the early 19th Dynasty, is well visible on the doorjamb. The texts on the doorjamb reveal, however, are neatly arranged according to the “ideal squares”.

Devéria’s Photograph of the Tomb of Ptahmose: Description of the Reliefs in the Doorway

Notes on the Architecture

The doorway in the tomb of Ptahmose was still in a reasonably good condition at the time of Devéria’s visit. The mudbrick walls with limestone revetment were standing to nearly their original height. Only the upper course of blocks is missing on the north reveal. The relief(s) on the south reveal must have been preserved to exactly the same height: part of the limestone revetment is visible behind the left-hand doorjamb. The walls’ measurements can be estimated using relief Cairo JE 4874, which measures 62 × 47 cm (h × w). This allows for a total visible height of 178 cm. An undecorated dado can be discerned, which indicates that the lower section of the walls is concealed by sand. The undecorated dado underneath a similar scene in the nearby tomb of Pay measures 26 cm,¹⁰³ which accords well with the undecorated dado visible in the photograph of the scene with boatmen in a tilting match (I.18).¹⁰⁴ Taking that measurement, the photograph of Devéria captured just about the total height of that wall. The width of the doorway, measured between the two reveals, can be reconstructed at approximately 162 cm.

The two photographs of the tomb taken by Devéria present important information on the architecture. Both indicate that the walls are constructed with a mudbrick core to which a limestone revetment is added. The construction method is an important chronological denominator when considering monumental New Kingdom tombs at Saqqara. The mudbrick core with limestone revetment is characteristic for tombs of the late 18th Dynasty. During the Ramesside period, walls are constructed exclusively of limestone blocks. Tombs that can be dated to the timeframe Ramesses I to Seti I have not been excavated yet.¹⁰⁵ It is to be expected that tomb construction did not change suddenly from one dynasty to the next. This is likely to have been a gradual process. The tomb of Ptahmose appears as a hybrid structure with “traditional” late 18th Dynasty architecture to which Ramesside novelties, such as the *djed*-pillars,

¹⁰² LOPRIENO 1995, p. 21-22. The altered disposition of signs starts already during the Amarna period: JUNGE 2001.

¹⁰³ RAVEN 2005, scene [7], p. 24, pl. 20-21: tomb of Pay, panel on the north jamb, east face of the east doorway to the inner courtyard.

¹⁰⁴ The photograph includes a measuring rod.

¹⁰⁵ HAYS 2011, p. 88. An exception is the mudbrick forecourt built by Raia (D. 19, early) against the tomb of his father, Pay (D. 18, late), which

he appropriated for his own use. The north-south oriented tomb of the Chief overseer of the royal harim Tjuroy called Ramessesnakht (ST 211) is dated to the period Seti I to Ramesses II, but has remained unpublished (see TAWFIK 1991a, p. 406, fig. 1; GOHARY 1991a; GOHARY 2011). The monuments from other “hidden” tombs dated to the reign of Seti I are: General Iurokhy/Urhiya (LS 25): LD Text, I, p. 182; RUFFLE, KITCHEN 1979; General Kasa: PM III², 745, BERLANDINI 1977, p. 38-

44; Overseer of the royal apartments of the harim at Memphis, Hormin (LS 29): PM III², p. 664-665; Head of goldworkers of the house of Seti I, Sayempetref: PM III², p. 716-717, Overseer of the army, Kasa: PM III², p. 745, Great scribe of the water in the temple of Seti I in the house of Amun, Amenmose: PM III², p. 773, and the Scribe of the offering table of the Lord of the Two Lands and Festival conductor of Osiris, Amenhotep Huy: HÖLZL 2007, p. 106-107; HOFMANN 2004, pl. XXVIII,⁷⁷

are added.¹⁰⁶ A study of the architecture and decoration of this tomb can shed more light on the overall development of funerary monuments at Saqqara during the New Kingdom.

Decoration: Technical Observations

The standing figures of Ptahmose and Inehyt, the block frieze bordering that scene, and the figures and texts on both panels are executed in raised relief. The inscriptions on the door-jams are incised, and the text column in front of the standing figure of Ptahmose is executed in a different manner. That text column is raised from the background of the image area,¹⁰⁷ and the individual signs appear to be executed in raised relief.¹⁰⁸ To find both text and image executed in raised relief is uncommon. Rare examples are found in the tombs of Maya and Mery-Neith.¹⁰⁹

Reliefs Florence 2557 (I.4), Leiden AP 54 (I.5), and Liebieghaus IN 1643 (I.6) have text columns carved like raised labels, hieroglyphs incised. Parallels can be found in the immedi-

(stelae Vienna ÄS 178, purchased by Burghart, 1821; Vienna ÄS 123); HÖLBL 1985, p. 18-23, pl. VIII (Museo Archeologico Nazionale di Napoli 1016).

106 Similarly, two additional tombs photographed by Devéria in 1859 (Khay and Ptahemwia), also date to the early reign of Ramesses II. Their superstructures are likewise constructed of mudbrick. Moreover, the tomb of Khay also contains *djed*-pillars. Their iconography closely resembles those from the tomb of Ptahmose. The tomb owner is depicted standing, hands raised in adoration (PASQUALI 2013, fig. 11). For other examples, see: Chief steward in Memphis, Netjerwymes/Nemtyemes (Bubastieion I.16, D. 19, temp. Ramesses II: ZIVIE 2003, fig. on p. 121), the General Iurokhy/Urhya (pillar Cairo JE 65061, tomb LS 25, D. 19, temp. Ramesses II, early: GAUTHIER 1935, pl. I); the Head of chamberlains of the Lord of the Two Lands, Iry-iry (*djed*-pillar fragment Copenhagen, Ny Carlsberg Glyptotek ÆIN 45 45, D. 19, temp. Ramesses II: KOEFOED-PETERSEN 1956, pl. XXX [77]); and Amenhotep/Pendua (Cairo TN 20.1.25.5, Ramesside: VAN DIJK 1986, No. 15, pl. 1 [2]).

107 Compare e.g. relief of Ipy: PASQUALI, GESSLER-LÖHR 2011, p. 290, fig. 1; references to other examples on p. 291 n. 53. The columns of text were incised directly on the surface and the background was lowered, which resulted in the text columns appearing as “irregularly shaped

labels”. See also HOFMANN 2004, p. 150, who indicates that this feature occurs already on Old Kingdom stelae and that its application in tomb decoration re-emerges at the beginning of the reign of Ramesses II.

108 This, however, is very difficult to ascertain.

109 Maya: entrance doorway, north reveal (G.T. MARTIN 2012, scene [3], pl. 79); Mery-Neith: north wall of court (RAVEN, VAN WALSEM 2014).

110 Mery-Ptah: GESSLER-LÖHR 2007b, fig. 1.7 (relief Karlsruhe, Badisches Landesmuseum H.1046); Maya: G.T. MARTIN 2012, scene [35], pl. 91; Horemheb: G.T. MARTIN 1989, scene [70], pl. 96; Ipy: PASQUALI, GESSLER-LÖHR 2011, fig. 1 (Chief steward Ipy, son of Chief steward Amenhotep Huy, temp. Amenhotep IV-Horemheb). For more references, see PASQUALI, GESSLER-LÖHR 2011, p. 290-291 n. 51-52. A further parallel of the late 18th to early 19th Dynasty, and of unknown provenance (but likely from Saqqara), is a relief from the tomb of the Overseer of scribes of the Lord of the Two Lands, Rama (Universität Leipzig, Inv.-Nr. 5069: ANONYMOUS 1981, p. 16-17, fig. 14; KRAUSPE 1987, p. 44-45, cover illustration). In the Amarna/post-Amarna period tomb of Mery-Neith, a text column was executed first in raised relief and was converted halfway its length to a raised label with text in sunk relief (north wall of courtyard: RAVEN *et al.* 2001-

2002, fig. 1; RAVEN, VAN WALSEM 2014, scene [30], p. 124 n. 110).

111 Cairo TN 19.6.24.15-17: QUIBELL 1912, pl. LXVIII[1]; PM III², p. 667-668. Examples from Thebes: Vizier Paser (TT 106, temp. Seti I-Ramesses II, early: HOFMANN 2004, fig. 32); High Priest of Amun Nebwenemef (TT 157, temp. Ramesses II, early: HOFMANN 2004, fig. 35-36, 46).

112 Examples include: Leiden AP 56 (V51) (rectangular naos stela, Overseer of cattle of Amun, Djehuty, D. 18, late, provenance unknown, ex-coll. d’Anastasi 1828: BOESER 1913, p. 11, pl. XXII [40]; AFFARA 2010); Louvre C149 [N298] (rectangular naos stela with pyramidion of the Stable master of the Lord of the Two Lands, Disuemib, D. 18, late, provenance unknown; ex-coll. Drovetti 1827: ÉTIENNE 2006, cat. 129); Berlin 2791 (Kamose, Abydos D. 19: MÜLLER 1991, p. 142-143 [86]); Museo Archeologico Nazionale di Napoli 1016 (round-topped stela of the Scribe of the altar of the Lord of the Two Lands Amenhotep Huy, D. 19, early, temp. Seti I: HÖLBL 1985, p. 18-23, pl. VIII; HOFMANN 2004, fig. 37); TNM: B13 (Teti pyramid north, Saqqara, D. 18, late: OCKINGA 2012, p. 385-388, fig. 5); SAK 2004-R 6 (niche shaped stela of Raia, D. 19, temp. Seti I: RAVEN 2005, scene [72], pl. 76-77: scene in raised relief; inscription on the raised labels in sunk relief).

ate post-Amarna tombs of Mery-Ptah, Maya, Horemheb, and Ipy.¹¹⁰ This feature is even less common for the 19th Dynasty. One example is presented by a relief block of the Steward of the Lord of the Two Lands, Horemheb.¹¹¹ Examples are also known for stelae¹¹² and statues.¹¹³

A relief fragment found near—but not necessarily belonging to—the tomb of the Chief goldsmith Amenemone (Teti pyramid cemetery) has a representation executed in raised relief *and* a raised label-shaped column with text in raised relief.¹¹⁴

Although this feature appears most often during the late 18th Dynasty, it cannot be used *per se* as a dating criterion.¹¹⁵ Van Dijk¹¹⁶ noted that the use of inscriptions carved in sunk relief on a raised panel is confined to high quality workmanship dating to the late 18th Dynasty until the earlier decades of the reign of Ramesses II. However, at least one 20th Dynasty example is known as well.¹¹⁷

Scene on Devéria Doorway Reveal: Iconography and Style

In the doorway, Ptahmose is depicted standing, facing left, his right foot positioned in front of his left (fig. 1-2). He holds a double staff (*mdw* and *w3s*) in his right hand and both a sceptre (*shm*) and long, folded napkin in his left.¹¹⁸ Inehyt is positioned standing behind her husband and she grasps him by the arm. In her left hand she holds a *menat*.¹¹⁹ The blocks that bore the reliefs depicting their heads are now missing. One can just recognize the lower portion of their wigs. The lower tip of the striated, duplex wig of Ptahmose is visible.¹²⁰ Inehyt probably wears a long, braided wig.¹²¹

¹¹³ MMA 15.2.1, dyad of the Chief scribe Iuny with his wife Renenutet, D. 19, temp. Seti I. The back of the statue features a stela, with the text incised on raised labels. The statue was found in or near the tomb-chapel of Iuny's father, the Chief physician Amenhotep, at Khashaba, Asyut, excavated by Ahmed Bey Kamal (1913-1914) on behalf of Sayyid Bey, local merchant and art collector (KAMAL 1916, p. 86-89 (no. 74); PM IV, p. 269; KRILL, 352-353; BERMAN 1999, p. 250-252; MMA online catalogue accessed 02.07.2013, www.metmuseum.org). The same raised labels are also present on a relief from the Asyut-tomb of Amenhotep (Deir Durunka). Now: Cleveland Museum 1963.100 and Archaeological Institute of the University of Zurich 1963/36 (formerly: Kunsthau Zürich, BERMAN 1999, fig. on p. 250-252, cat. no. 180); HOFMANN 2004, fig. 164. More blocks from the tomb are now in Berlin, 1/64, 2/64, 2/63, 3/63 (KARIG 1967, p. 75-76, fig. 805; KARIG 1969) and Toledo Museum of Art 62.24 (PECK 2011, p. 66-67, with fig. on p. 67).

¹¹⁴ OCKINGA 2004, pl. 36 (fragment TNE 94: F93). The tomb of the army scribe Huy is suggested as provenance (OCKINGA 2004, p. 109, n. 183; cf. QUIBELL, HAYTER 1927, pl. 19). For the tomb of Huy (D. 18, late, temp. Ay-Horemheb), see: WENIG 1974; OCKINGA 2012, p. 374-377 and fig. 1 on p. 373.

¹¹⁵ PASQUALI, GESSLER-LÖHR 2011, p. 291.

¹¹⁶ VAN DIJK 1989, p. 53.

¹¹⁷ Dra Abu el-Naga, tomb of Ramessesnakht, K93.II: POLZ 2007, fig. 332. The raised labels are also present on stela fragment Vienna ÄS 9226 (provenance unknown), which has been dated by HÜTTNER, SATZINGER 1999, p. 142-144, to the time of Amenhotep III. It might actually date to the late 18th Dynasty.

¹¹⁸ These are the symbols of authority, referring to his role in ruling bureaucracy. The same combination of symbols form the determinative of the word for "official" (*sr*, Gardiner A21): ROBINS 2008, p. 211.

¹¹⁹ STAEHELIN 1982, col. 52-53. Compare e.g. Meryt, assuming the same pose as Inehyt, standing behind her husband, Maya: LD III, pl. 240a; G.T. MARTIN 2012, scene [30], pl. 25. A relief block of unknown provenance (Hannover, Museum August Kestner 1935.200.182, probably Saqqara) depicts an anonymous man, arms raised in adoration. His wife stands behind him, right arm raised, holding a sistrum and *menat* in her left hand (G.T. MARTIN 1987, p. 36 [88], pl. 34, 53). For a similar composition at Thebes, see TT 41: Amenemope and Nodjmet (temp. Horemheb-Seti I, ASSMANN 1991, scene [40], pl. XXXVb, 29).

¹²⁰ Compare Maya: G.T. MARTIN 2012, scene [1-2], pl. 8, 78; scene [30], pl. 24, 90; General Amenemone, Hannover, Museum August Kestner 1935.200.186: DJUŽEVA 2000, p. 97 [Dok. 17]; DRENKHahn 1989, fig. 33.

¹²¹ Compare e.g. to Meryt in the tomb of Maya: G.T. MARTIN 2012 scene [30], pl. 25.

The scene in the doorway of Ptahmose and Inehyt contains some features for which only few parallels can be found in the tombs of other New Kingdom officials buried in the Memphite necropolis.

1. Naturalistic Representation of Two Feet

Human figures in Egyptian art are commonly represented with two similar feet, as if both are viewed from the inside. A differentiation between far and near foot is exceptional, and is more commonly used for royals than for private people.¹²² Both Ptahmose (wearing sandals) and his wife (barefoot) are provided with two different views of their feet. Only a limited number of similar representations can be identified at Saqqara.¹²³

Two parallels are presented by the *djed*-pillars of Ptahmose (Leiden AP 51a, d). Note that the two other pillars present him with two identical feet.

In the cemetery south of the Unas causeway, a further three parallels can be identified.¹²⁴ In the tomb of the Director of the harim, Pay, no less than three scenes depict the deceased with a naturalistic presentation of his feet. In two scenes, Pay is seated on a chair while his feet are positioned side by side and therefore only the near foot is visible.¹²⁵ The third scene bears more resemblance to that of Ptahmose.¹²⁶

In the Teti pyramid cemetery, “two feet” are attested only in the tomb of the Chief goldsmith Amenemone.¹²⁷ It should be added that he is depicted exclusively barefoot.

The depiction of two different feet in Theban private tombs of the New Kingdom is similarly uncommon, although examples are more numerous compared to Saqqara.¹²⁸ At Saqqara this

¹²² See RUSSMANN 1980. Russmann concludes that the differentiation between near and far foot started during the reign of Thutmose IV (first in paint, later in relief), initially only to represent female servants and female members of the family. Its exclusive use for members of the royal family during the Amarna period continued into the reign of Tutankhamun. However, RAVEN (2005, p. 54-55) noted that private individuals could be represented accordingly prior to the reign of Ay, as did Pay, a contemporary of Tutankhamun, in his tomb at Saqqara.

¹²³ Only feet depicted in a side-view, positioned flat on the surface, are taken into consideration. This excludes representations of the underside of a foot (e.g. Paatenemheb, Leiden AMT 1-32: BOESER 1911, pl. III; Mery-Neith: RAVEN, Van WALSEM 2014, scene [30], kneeling female figure, north wall of court, east end; Horemheb: G.T. MARTIN 1989, scene [110b], pl. 130, kneeling tomb owner, fragment; G.T. MARTIN 1989, scene [113], pl. 135, kneeling female figure,

south thickness of doorway to central chapel), and the representation of toes for kneeling figures (e.g. ZIVIE 2009, pl. 26-27).

¹²⁴ This number excludes relief fragment SAK 2009-R13 (unpublished), found by the Leiden-expedition in (but not necessarily belonging to) the Ramesside chapel of the *w' b n(.t) h: t n(.y) Pth*, “*wab*-priest of the front of Pth”, called Khay II (nr. 2009/6), located immediately due south of the first court of the tomb of Horemheb. The relief contains the near foot of a seated male (?) figure and two smaller feet (non distinct) approaching the seated figure. I thank Maarten Raven for information on its provenance and Peter Jan Bomhof for a photograph. For a preliminary report on the excavation of the 2009 season, see: RAVEN *et al.* 2010, p. 5-24 (Khay II: p. 6-9).

¹²⁵ 1) RAVEN 2005, scene [25], p. 30, pl. 36-37, west wall of inner court, between central and south chapel. Only the lower part of the scene is preserved; 2) RAVEN 2005, scene [50], p. 36, pl. 54-55,

antechapel, north wall. Again, only the lower part of the wall is preserved. In scene [25] Pay wears sandals, in scene [50] he does not.

¹²⁶ RAVEN 2005, p. 35-36 [49], pl. 50-51, antechapel, north screen wall, east face. ¹²⁷ 1) OCKINGA 2004, scene [10], pl. 18, 65 (Cairo TN 29.6.24.8), south chapel: tomb owner and wife standing, only lower part preserved; 2) OCKINGA 2004, scene [11], pl. 19, 66 (Cairo TN 27.6.24.2), south chapel: tomb owner sitting on a chair and a woman sitting on a pillow, besides the chair; 3) OCKINGA 2004, scene [12], pl. 20 (Cairo TN 17.6.25.1), portico, only tomb owner depicted; 4) OCKINGA 2004, scene [14], pl. 23, portico, tomb owner sitting on a chair, approached by offering bearers.

¹²⁸ These tombs include, but are not necessarily limited to: TT 31, Khons (temp. Ramesses II: DAVIES 1948, pl. XI; figure of the owner); TT 41, Amenemope (temp. Horemheb-Seti I: ASSMANN 1991, pl. 13 [4], 25 [34], 26 [35-6], 27 [37], 60 [141]; HOFMANN 2004, pl. III, 8; all figures of the owner); TT 51, Userhat

stylistic feature appears to be temporally constrained to the timeframe Tutankhamun-Seti I. At Thebes, this feature is chronologically more diffused. The earliest example can be dated to the reign of Amenhotep III (TT 8, TT 69), and the latest to the 20th Dynasty (TT 341). Nearly all examples are painted. Only TT 41 of Amenemope (temp. Horemheb-Seti I) is executed in relief.

The Memphite tombs of Horemheb and Maia also include royal figures with naturalistically represented feet. In her tomb near the Bubastieion (I.20), the child Tutankhamun sits on Maia's lap.¹²⁹ His feet are positioned side by side and therefore only the near foot is completely visible. The area containing Maia's feet is damaged. In the tomb of the General Horemheb, Tutankhamun and Ankhnesenamun feature in two scenes. On each occasion they are represented with two different feet, wearing sandals.¹³⁰ Horemheb also features in these scenes, but his feet are depicted in the traditional manner.

Name	Tomb	Title	Feet		Sandals		Date
			♂	♀	♂	♀	
<i>Īmn-m-īnt</i>	Teti Pyr. (Loret no. 2)	<i>hr.y nbw.w n(.w) nb t3.wy</i>	√	√	?	?	D. 18 (Tut)
<i>P3y</i>	Unas, south (LS 28)	<i>īmy-r īpt-nsu n(.y) nb t3.wy / n(.y) mn-nfr</i>	√		√		D. 18 (Tut-Hor)
<i>Pth-ms</i>	Unas, south	<i>h3.ty-ꜥ wr n(.y) īnb.w-hd</i>	√	√	√		D. 19, early
<i>Mꜥ i3*</i>	Bubastieion (I.20)	<i>mnꜥ.t nsw(.t) šd.t nb t3.wy</i>	√		√		D. 18 (Tut)
<i>Hr-m-hb*</i>	Unas, south	<i>īmy-r īm.yw-r msꜥ n(.y) nb t3.wy</i>	√	√	√	√	D. 18 (Tut)

TABLE 1. Naturalistic representation of two feet, as attested in the corpus of New Kingdom tombs at Saqqara. Asterisks indicate royal figures.

(temp. Seti I, Userhat and his wife and mother, sitting; and two women standing behind Userhat, adoring Osiris: DAVIES 1927, p. 6-9, frontispiece, pl. V-VII, IX, XA; WILKINSON, HILL 1983, fig. 39; HOFMANN 2004, fig. 18); TT 65, Nebamun; usurped by Imiseba (temp. Hatshepsut and Ramesses IX, Imiseba and relatives: unpublished tracings of Norman and Nina de Garis Davies at the Griffith Institute, Oxford, accessed 25.03.2013, http://www.griffith.ox.ac.uk/gri/4TT65_intro.html); TT 111, Amunwakhstu (temp. Ramesses II, second half, figure of the tomb owner: HOFMANN 2004, pl. VIII, 21); TT 217, Ipuy (temp. Ramesses II, first half; DAVIES 1927, pl. 23 (tomb owner and wife), 24 (wife only); tomb owner with two similar feet), 25 (deceased couple and their son acting as a priest; their

daughter represented with two similar feet); TT 271, Nai (temp. Ay, the tomb owner and his wife seated before an offering table: HABACHI, ANUS 1977, pl. IIIB; HOFMANN 2004, fig. 17); TT 278, Amenemhab (late D. 19, tomb owner and wife, seated in front of a tree goddess: VANDIER 1954, pl. 32); TT 324, Hatiay ("post-Amarna"; HOFMANN 2004, p. 18-20); DAVIES 1948, pl. XXXII (tomb owner and wife, twice), XXXIV (tomb owner and wife), XXXVI (only tomb owner, twice); TT 331, Pa-en-niut/Penre (temp. Ramesses II, first half; KAMPP 1996, p. 577; DAVIES 1948, pl. XXXVII (tomb owner), XXXVIII (female figure); TT 341, Nakht-Amun (D. 20, various representations, including the tomb owner, his wife(?) and son: DAVIES 1948, pl. XXIV-XXVII). In addition, RUSSMANN 1980, p. 77

(with bibliographical references), lists seven examples from Theban private tombs of the pre-Amarna period: TT 8 (temp. Amenhotep III), Kha; TT 38, Djoserkaraseneb; TT 69, Menna (Amenhotep III); TT 78, Horemheb; TT 139, Paury; TT 181, Nebamun and Ipuy (fragments BM EA 37977/37986).

¹²⁹ ZIVIE 2009, pl. 21, 52. A comparable scene can be observed in the Theban tomb of Qenamun (TT 93), depicting the future king Amenhotep II seated on the lap of Amenemope, although with two similar feet (ZIVIE 2009, p. 99, fig. 4).

¹³⁰ 1) G.T. MARTIN 1989, p. 94-97 [76], pl. 112 (Leiden H.III.SSSS: BOESER 1911, p. 6-7, pl. XXIII), and 2) G.T. MARTIN 1989, p. 87-92 [72], pl. 108.

2. Double Staff

In the doorway, the standing Ptahmose is equipped with the regalia that mark his high status. In his left hand he holds a *šhm* sceptre¹³¹ in combination with a folded “handkerchief” or “napkin”.¹³² As early as the Old Kingdom, the napkin is associated with high officials. From the Amarna period onwards it appears as a long, folded cloth that is often pleated and fringed at one end.¹³³ Ptahmose’s napkin appears to be neither pleated nor fringed.

In his right hand Ptahmose holds two full-size staffs of different type. One staff has a forked end, the other ends straight. There can be little doubt that the bifurcated staff represents the *wšs*-sceptre.¹³⁴ The second staff can be undoubtedly identified as the so-called staff-of-office, or *mdw*, characteristically held by high ranking officials.¹³⁵ The *wšs*-sceptre is associated primarily with deities and only rarely held by common people.¹³⁶ If indeed an official is attested with a *wšs*-sceptre, it is almost without exception in combination with a staff-of-office.

The corpus of Memphite New Kingdom reliefs includes another twelve such examples from ten individual tombs (table 2): Maya (3 scenes),¹³⁷ Mery-Neith,¹³⁸ Horemheb,¹³⁹ Raia,¹⁴⁰ Paatenemheb,¹⁴¹ Mery-Sekhmet,¹⁴² Ptahmose,¹⁴³ Ramessesnakht,¹⁴⁴ a relief block

¹³¹ Also commonly referred to as *hry*: BARTA 1984, col. 772-776.

¹³² He holds the same sceptre-and-napkin combination in relief Florence 2557 (lower register; napkin without fringed end), Cairo JE 4874 (long end of napkin fringed: fig. 3), and Cairo TN 25.6.24.6 (short end of napkin fringed).

¹³³ PASQUALI, GESSLER-LÖHR 2011, p. 293 with n. 68-72. The traditional short, cord-like napkin started to be replaced by this longer form during the reign of Amenhotep III.

¹³⁴ See: K. MARTIN 1986, col. 1152-1154; p. 6. The words *‘bš*, *šhm* and *hry*, all designate the same staff: † (Gardiner S42). For the symbolism of the *wšs*, see Te Velde 1967, p. 89-91. The *D’m* is closely related and has a spiral shaft. For the giraffe and “serpopard” eventually becoming the *wšs*-sceptre, see: WESTENDORF 1966, p. 207-208. According to Gordon and Schwabe (GORDON, SCHWABE 2004, p. 138-145), the *wšs* and *D’m* originated from a dried bull’s penis. In the tomb of Neferhotep (TT 49: DAVIES 1933, pl. XLVII, below), a servant, standing behind his superior, is depicted holding a long stick with bifurcated lower end; the upper part ends straight. Its length is too long to be used as a staff, and must have had a different function. The same staff is held by two servants bringing supplies (contained in baskets) to the

temple: DAVIES 1933, pl. XLV (inner room, north wall, below, left). For the lower fragment of a wooden, bifurcated staff found in the tomb of Amenemope (TT 41, see ASSMANN 1991, p. 242 [179], pl. LXXIIa-c.

¹³⁵ Ptahmose is shown holding this staff only in relief Cairo TN 25.6.24.6 (I.7).

¹³⁶ KUHLMANN, SCHENKEL 1983, II, p. 79 n. 310.

¹³⁷ 1) Doorway to chapels B and C; probably from north reveal (Leiden F 1993/8.1: G.T. MARTIN 2012, p. 26 [18a], pl. 21, 88 [1]); 2) Doorway statue room to inner court, south reveal (LDIII, pl. 240a; G.T. MARTIN 1991, pl. VIII; G.T. MARTIN 2012, scene [30], p. 30-31, pl. 24-25, 90 [1]); 3) Doorway statue room to inner court, north reveal (LDIII, pl. 240d (now lost); G.T. MARTIN 2012, scene [28], p. 30, pl. 23). Scene 3 from the tomb of Maya, copied by Lepsius in 1843, appears to contain two *wšs*-sceptres (only the lower parts of the staffs are preserved), which is likely to be an error made by the draughtsperson copying this relief. Compare: G.T. MARTIN 2012, scene [30].

¹³⁸ RAVEN *et al.* 2001-2002, fig. 1; VAN WALSEM 2001, fig. 3; RAVEN, VAN WALSEM 2014, scene [29]. The scene is located on the north wall of the courtyard and depicts the statues of Mery-Neith and his wife Anuy, positioned on a sledge, and facing left (west).

¹³⁹ G.T. MARTIN 1989, p. 84 [70], pl. 96-97.

¹⁴⁰ RAVEN 2005, scene [41], p. 33-34, pl. 44-45: south thickness of south chapel. The upper part of the scene that contained the upper end of the staff is lost. In his other (*i.e.* left) hand, the deceased holds a “lettuce” sceptre and a folded cloth.

¹⁴¹ BOESER 1911, p. 3, pl. V: chapel, east wall (west face), north part. Tomb owner standing (wearing sandals), his wife is positioned standing behind him (barefoot). In front of the tomb owner, two servants are depicted on two superimposed register lines. The lower servant carries sandals in his left hand, and appears to present the double staff to the tomb owner. The appearance of the upper end of both staffs held by Paatenemheb cannot be ascertained since the scene’s upper part is not preserved. The image of the servant, however, is fully preserved and shows the staffs full-length: indeed the *wšs* and *mdw* sceptres. The servant standing on the upper register line, partially preserved, offers a libation and carries the tomb owner’s folded napkin.

¹⁴² ZIVIE 2000, p. 189, fig. 5.

¹⁴³ Triangular-shaped stela Florence 2537 from Saqqara (ex-coll. Di Nizzoli 1824): BOSTICCO 1965, p. 41-42 [34].

¹⁴⁴ Relief fragment Brussels E.5183: BERLANDINI 1979, p. 249-253, pl. LI.

of an anonymous official,¹⁴⁵ a block of an anonymous vizier,¹⁴⁶ and on a relief of unknown provenance and ownership.¹⁴⁷ Note that in the representation of Raia, the lower part of the staff-of-office overlaps the forked staff, while for Ptahmose, Paatenemheb, Mery-Neith, Maya and Horemheb this is the other way round. In the tomb of the Chief goldsmith Amenemone, the double staff is held by the figure of the deified king Menkauhor.¹⁴⁸ Further scenes in the tombs of Pay (and Raia)¹⁴⁹ and Maya¹⁵⁰ contain a double-staff combination of two identical staffs-of-office, while a scene from the tomb of the General Amenemone contains two staffs of which neither top nor bottom are preserved.¹⁵¹

At Thebes, the double staff (*wꜣs* and *mdw*) is found in the tombs of Viceroy Amenhotep Huy (TT 40),¹⁵² Ibi (TT 36),¹⁵³ Basa (TT 389),¹⁵⁴ and the Mayor Paser at Medinet Habu.¹⁵⁵ In the tomb of Amenemhat (TT 82), an offering bearer is depicted while carrying a chest with loin-cloths, vulture pectorals, bracelets, etc., while also holding a *dꜣm*-sceptre, and another man carries a vessel stand with vessels, while holding a *wꜣs*-sceptre.¹⁵⁶ These objects

145 IBRAHIM ALY 1998, p. 221 [4], pl. 22d: the block was found during restoration work near the chapel of the South Tomb in the Djoser complex at Saqqara, and may derive from the area around the Unas causeway, where it was removed during previous excavations. The block is now in Saqqara Magazine No. 4. The seated tomb owner can be seen holding the *shꜣm*-sceptre and double staff. The decoration in the lower area of the block has vanished, while the scene breaks off at the upper edge of the block. It is not clear, therefore, which staff combination is depicted here. It is possible that traces of the stylised animal head, to indicate the *wꜣs*-sceptre, are visible. Part of his title is visible: *m hꜣw.t n 'bꜣf'*. This can be indicative of the Mayor Amenhotep Huy, who held the title *im.y-r pr m ꜣ hꜣw.t nbꜣf*, "Steward in the temple of His Lord". During the restoration work another block from his tomb was found (Ibrahim Aly 1998, p. 222-223 [6], pl. 23b), which has the same thickness (21 cm).

146 Stockholm, Medelhavsmuseet NME 26: PM III², 761; LIEBLEIN 1868, p. 23 [26]; MOGENSEN 1919, p. 50-51; PETERSON 1974, p. 8-10, fig. 2. The relief fragment (60 × 44 cm) was acquired before 1868 and is of unknown provenance. Parts of two registers are preserved. In the upper register, the feet of a seated man are visible on the right, the base of an offering table in the centre, and a rectangular base and the lower part of the double staff on the left. In the

lower register, a Scribe of the room of gifts of Pharaoh I.p.h. (*šꜣ n 't hꜣnq.t pr.wy-ꜣꜣ 'u.s.*) named *Rꜣ-ms-s(w)-nhꜣt n(y) Mn-nfr* presents incense to the seated deceased couple: a man wearing the typical vizier's garment and his wife, both without name and title. The same vizier possibly holds the double staff in the upper register. As the Vizier is not indicated by name, the block possibly belonged to an official (Ramesesnakht?) who included a representation of the Vizier in his tomb. Note that the tomb of the Vizier of the North (Pa-)Rahotep (temp. Rameses II, 2nd to 6th decade) is located at Sedment (Cemetery B, tomb 201), and the location of the tombs of Nebamun (temp. Horemheb-Rameses II) and *Ỉri*[...] (6th decade?) are as yet unknown (RAEDLER 2004, with tables 1, 2). Neferrenpet, Vizier of the South and High Priest of Ptah at Memphis (Rameses II, end 6th decade) had a tomb at Saqqara (ST 101: TAWFIK 1991, 404, fig. 1, pl. 56, 57a).

147 Relief Linköping, Stifts- och Landsbibliothek: G.T. MARTIN 1987, p. 19 [38], pl. 13; PM III², p. 759. The name of the deceased is partly preserved, concluding with a "bird sign", while a second name ends with */ly*, and his titles include that of *šꜣ nsꜣw.t*, "Royal scribe". His wife is called Ty and has the title *šꜣmꜣy.t n(t) nb.t nb.t*, "Songstress of the Lady of the Sycamore" (*i.e.* Hathor).

148 Relief Louvre B 48: BERLANDINI-GRENIER 1976, pl. 53; OCKINGA 2004, scene [13], pl. 21, 68.

149 Three scenes: 1) associated with Pay: RAVEN 2005, scene [49], p. 35-36, pl. 50-51, antechapel, north screen wall, east face (lower part of scene preserved); 2 and 3) Pay or Raia, fragmentarily preserved scenes: RAVEN 2005, scene [51], p. 36, pl. 52-53, sanctuary, south screen wall, west face; RAVEN 2005, scene [57], p. 38-39, pl. 53-54, sanctuary, north screen wall, west face.

150 G.T. MARTIN 2012, scene [20], pl. 21, 88,2 (= Frankfurt, Liebieghaus St. P 425).

151 On relief Louvre B8 of the General Amenemone: VANDIER 1973, p. 28, pl. XI[2]; DJUŽEVA 2000, p. 87, Dok. 12, pl. 3.

152 DAVIES 1926, pl. 35: one wall, four scenes: half-sized sceptres, being one double staff (right, second scene from above, while a Lector priest "makes purification with bowls of water") and three *wꜣs* sceptres.

153 KUHLMANN, SCHENKEL 1983, scene [17], pl. 29 and scene [148], pl. 61. Note that the double staff continues only as *wꜣs*-sceptre above the hand of the tomb owner.

154 ASSMANN 1973, II, scene 6, T. 23, pl. IX. Note that both staffs have a forked end.

155 SCHOTT 1957, pl. I (temp. Rameses III).

156 Steward of reckoning grain of Amun; 18th Dynasty, temp Hatshepsut-Thutmosis III: DAVIES, GARDINER 1915, p. 49-50, pl. XI (passage, south wall, upper register).

are destined for the tomb of Amenemhat. Other examples worth mentioning are P. Louvre N 3092 of Neferwebenef, vignette with Book of the Dead Chapter 110,¹⁵⁷ and the vignette with BD Chapter 110 of Yuya, father-in-law of Amenhotep III, overseeing activities in the Fields of Iaru, while two attendants bring offerings, including a libation.¹⁵⁸ The deceased owner of the papyrus is depicted holding a *wꜣs*-sceptre and *ꜥnb*-sign. In the Memphite tomb of Horemheb, the upper register of the scene representing the Fields of Iaru depicts one attendant presenting two staffs to Horemheb: one *wꜣs* and one *mdw* staff.¹⁵⁹ A second attendant libates. It is interesting to note that the fields of Iaru are included on the east wall, south side, of the chapel of Paatenemheb, and that the tomb owner, facing right (south), receives the double staff from his attendant on the same wall, north side, which is on the opposite side across the doorway.¹⁶⁰ The staff thus marks the deceased's newly acquired status of life after death, as Norman de Garis Davies already noted in relation to the scenes in the tomb of the Viceroy Huy: “[...] his attainment of sepulchral beatitude is marked by the *wꜣs*-sceptre (𓄿) which in some cases he holds.”¹⁶¹ This is enhanced further by the description associated with a scene in the tomb of Maya. This text indicates that Maya enters his tomb, a place where the god receives his offerings, “being given a staff” (see *infra*).

Name	Tomb	Title	𓄿	𓄿	Date
<i>ꜥmn-m-ꜥnt*</i>	Teti Pyr. (Loret no. 2)	<i>hr.y nbw.w n(.y) nb ꜥꜣ.wy</i>	√		D. 18 (Tut)
<i>ꜥmn-m-ꜥnt</i>	Lost	<i>ꜥm.y-r mꜥꜥ wr n(.y) nb ꜥꜣ.wy</i>	?	?	D. 18 (Hor)
<i>Pꜣ-itn-m-ꜥb</i>	Lost	<i>wbꜣ nsu wꜥꜥ ꜥ.wy</i>	√		D. 18 late
<i>Pꜣy</i>	Unas, south (LS 28)	<i>ꜥmy-r ꜥꜣt-nsu n(.y) nb ꜥꜣ.wy / n(.y) Mn-nfr</i>		√	D. 18 (Tut-Hor)
<i>Pꜣꜥ-ms</i>	Unas, south	<i>ꜥꜣ.ty-ꜥ wr n(.y) ꜥnb.w-ꜥꜣ</i>	√		D. 19, early
<i>Pꜣꜥ-ms</i>	Lost	<i>wr-ꜥꜣꜣ-ꜥmw.w</i>	√		D. 18 (A III)
<i>Mꜥꜣꜣ</i>	Unas, south (LS 27)	<i>ꜥmy-r ꜣꜣ.w-ꜥꜣ(.w)</i>	√	√	D. 18 (Tut-Hor)
<i>Mr.y-Nt / Mr.y-Rꜥ</i>	Unas, south (H9)	<i>ꜥmy-r ꜣꜣ n(.y) ꜥtm [m Mn-nfr]</i>	√		D. 18 (Akh-Tut)
<i>Mr.y-Sꜥm.t</i>	Bubastieion (I.5)	<i>ꜥmy-r ꜥmw.ty n(.y) nb ꜥꜣ.wy</i>	√		D. 18, late; D. 19, early
NN	Unknown	<i>sꜥ nsu.t ///</i>	√		D. 18/early 19
NN	Unas, south?	<i>/// m ꜥw.t nbꜥꜥf///</i>	√?		D. 19, R.II
NN	Unknown	<i>ꜥm.y-r nꜣw.t ꜣꜣty (?)</i>	√		D. 19, R.II
<i>Rꜥꜥꜣ</i>	Unas, south (LS 28)	<i>ꜥmy-r ꜥꜣt-nsu n(.y) (ꜣꜣ-ꜥnr.t m) Mn-nfr</i>	√		D. 18/early 19 (Hor-Seti I)
<i>Rꜥ-ms-sw-nꜥt</i>	Lost	<i>ꜥm.y-r mꜥꜥ</i>	√		D. 19 (R.II, first part)

TABLE 2. Depictions of the tomb owner holding the double staff, as attested in the corpus of New Kingdom tombs at Saqqara. Asterisk indicates royal figures.

¹⁵⁷ ANDREU-LANOË 2013, fig. on p. 210-211 [67] (Theban region, D. 18).

¹⁵⁸ DAVIS 1907, pl. XI; DAVIS 1908, p. 15-16, pl. XVIII. For the Fields of Iaru (*ꜥꜣt ꜥꜣw*), see LECLANT 1975, col. 1156-1160. The Fields are always localised in the East and have associations with Re.

¹⁵⁹ G.T. MARTIN 1989, scene [117], p. 123, pl. 137. Note that these men are standing “on top of” the outer canal and are therefore standing somewhere beyond the fields.

¹⁶⁰ For the Fields of Iaru in the chapel of Paatenemheb, see: BOESER 1911, pl. XII (Leiden AMT 1-35).

¹⁶¹ DAVIES 1926, p. 31.

3. Garments

In the doorway, Ptahmose wears a composite garment. It consists of a “bag tunic” with outward flaring ample pleated “sleeves” and “skirt” reaching to the ankles, in combination with a sash kilt wrapped around the buttocks and tied in front, resulting in a short “apron”.¹⁶² A knot is usually visible in front,¹⁶³ which here appears to be absent. The lower part of the short apron, which is formed by the fringed end of the sash kilt, appears to be smooth. The outer contour lines of the sleeves naturalistically take the form of the arms. The outlines of the right leg are clearly visible underneath the fabric.¹⁶⁴ Garments of comparable type are fairly common at Saqqara, typically worn by officials from the post-Amarna period onwards.¹⁶⁵

Over his shirt, Ptahmose wears a simple *wsh*-collar without clear visible evidence of the Gold of Honour, with which he is decorated in several representations from his tomb.¹⁶⁶ If indeed the *šbyw*-collar is absent, one could hypothesize that this doorway was decorated at a (relatively) early stage of his career. Otherwise, he would certainly have included it.¹⁶⁷

The image of Inehyt is not fully visible. Nevertheless, one is able to discern her ankle-length pleated robe. The now lost representation of Meryt in the tomb of Maya probably offered a close parallel, as does Nodjmet in the tomb of Amenemope (TT 41).¹⁶⁸

4. Position of the Wife’s Right Hand

The co-occurrence of a male tomb owner and his wife in one scene is widely attested in the private tombs of the New Kingdom. Couples can be represented either seated or standing. Without exception, the male tomb owner is positioned in front of his wife. The wife usually

¹⁶² After PASQUALI, GESSLER-LÖHR 2011, p. 292, fig. 1 (Ipy); cf. FREED 1982, p. 171-172. See also HOFMANN 2004, p. 168-169 (nr. 16, 18); VOGELANG-EASTWOOD 1993, p. 130-154 (bag tunics). The short “apron” is paralleled most often in the period between the end of the Amarna period and the early reign of Ramesses II (VAN DIJK 1989, p. 52), but, as Van Walsem (personal communication) points out, occurs as early as the reign of Amenhotep III (e.g. RUSSMANN 1989, fig. 47: double standing statuette of Khaemwaset and his wife Menena from Bubastis, Cairo JE 87911; RUSSMANN 1989, fig. 48: ebony statue of Tjay from Saqqara, Cairo JE 33255) and Akhenaten (Memphite tomb of Mery-Neith, tomb reliefs and statue Cairo JE 99076; RAVEN, VAN WALSEM 2014).

¹⁶³ G.T. MARTIN 1989, scene [73], pl. 109-110.

¹⁶⁴ Compare Ptahemwia: RAVEN *et al.* 2007, fig. 8 (Saqqara, D. 18, temp. Akhenaten-Tutankhamun); Mery-Neith: RAVEN *et al.* 2001-2002,

fig. 1 (Saqqara, D. 18, temp. Akhenaten-Tutankhamun); Ptahmose, BM EA 160: Bierbrier 1982, pl. 4-5 (Gizeh? D. 18, late). Mery-Neith is represented in raised relief; the others in sunk relief. Examples from Thebes, raised relief: Amenemope, TT 41: ASSMANN 1991, scene [40], pl. XXXVb, 29; Nebwenenef TT 157: HOFMANN 2004, p. 34, fig. 36 (temp. Ramesses II, early).

¹⁶⁵ GESSLER-LÖHR, in Pasquali, Gessler-Löhr 2011, p. 292-293 (with n. 66 on chronological implications pre/post-Amarna period, with the latter having longer and wider sleeves flaring outward and with many more pleats). Compare HOFMANN 2004, p. 168-169, nos. 16 and 18 (found at Saqqara already during the early post-Amarna period; in Theban tombs from the reign of Ramesses II onwards). Ptahmose wears the garment on his own monuments: I.1-2, I.4-7, III.5. Only on the *djed*-pillars (III.1-4) the bald-headed Ptahmose wears a distinctly different garment (cf. HOFMANN 2004, table on p. 167-168 (nr. 15)).

¹⁶⁶ To the left of the lower part of his wig, faint traces of what might be interpreted as the *šbyw*-collar can be observed. Scenes of Ptahmose decorated with the *šbyw*-collar: I.7, I.8, I.11, III.2 (two-row collar); III.3-4 (four collars of four strands). The two-row *šbyw*-collar is most commonly attested for officials decorated with the Gold of Honour: 187 out of 238 attestations during the New Kingdom (BINDER 2008, p. 211). The majority of his monuments show Ptahmose without the *šbyw*.

¹⁶⁷ Also PASQUALI, GESSLER-LÖHR 2011, p. 292: monuments of the Chief steward Ipy, son of Amenhotep Huy. According to Binder (Binder 2008, p. 219), a direct relation between the variation in the number of rows of a single collar, or the varying combinations of the *šbyw*, and hierarchy within the practice of rewarding cannot be determined with certainty.

¹⁶⁸ Maya: LD III, pl. 240a; G.T. MARTIN 2012, scene [30], pl. 25; Amenemope: ASSMANN 1991, scene [40], pl. XXXVb, 29, doorway to transverse hall, south reveal.

embraces her husband or holds his arm. At least six different embraces can be distinguished within this corpus at Memphis:

1. One hand positioned on the sleeve of the husband's upper arm; embracing him with the other arm, the hand appearing on the husband's shoulder¹⁶⁹ or chest;¹⁷⁰
2. Raising one hand, embracing the husband with the other, the hand appearing on the man's shoulder;¹⁷¹
3. Holding her husband's arm with one hand, the other disappearing behind his back;¹⁷²
4. Holding attributes (e.g. flowers) in one hand, and embracing the husband with the other arm, the hand appearing at his shoulder¹⁷³ or chest;¹⁷⁴
5. Holding an attribute in one hand, the other arm between his arm and torso, resting her hand on his lower arm;¹⁷⁵
6. Holding an attribute in one hand, while grasping the upper arm of the husband, positioning her hand between his arm and torso.

Position nr. 6 is demonstrated by Inehyt in the Devéria photograph. With just six parallels in six private tombs at Saqqara, this is a very uncommon position.¹⁷⁶

Name	Tomb	Title	Date
<i>Imn-m-Int</i>	Unas, south (ST 101)	<i>im.y-r pr.wy-hd n(.y) nb t.wy</i>	D. 19 (R II)
<i>Pth-ms</i>	Unas, south	<i>h.ty-^c wr n(.y) inb.w-hd</i>	D. 19, early
<i>M'yc</i>	Unas, south (LS 27)	<i>im.y-r pr.w-hd(.w)</i>	D. 18 (Tut-Hor)
<i>Mr.y-Nt / Mr.y-R^c</i>	Unas, south (H9)	<i>imy-r pr.w n(.y) Im [m Mn-nfr]</i>	D. 18 (Akh-Tut)
<i>Mr.y-Sbm.t</i>	Bubastieion (I.5)	<i>imy-r snw.ty n(.y) nb t.wy</i>	D. 18, late; D. 19, early
NN	Unknown	?	D. 18, late

TABLE 3. Wife of tomb owner embracing her husband, holding him by the upper arm (embrace nr. 6), as attested in the corpus of New Kingdom tombs at Saqqara.

¹⁶⁹ E.g. Nebansu (Cairo JE 33107/CG 34055; LACAU 1909-1916, p. 98-99, pl. XXXIII; GESSLER-LÖHR 2007a, p. 72-73, pl. 7; D. 18, temp. Amenhotep III); Horemheb (G. T. MARTIN 1989, pl. 58 [lower]; D. 18, late); Paser (stela BM 165; G. T. MARTIN 1985, pl. 9; D. 19, temp. Ramesses II); Mose (GABALLA 1977, pl. XIIa; temp. Ramesses II); Hori (Neuchâtel, musée d'Ethnographie 428; MÁLEK 1988, pl. XX; D. 20, temp. Ramesses III/IV).

¹⁷⁰ Iniui: SCHNEIDER 2012, scene [13], fig. III.28, pl. I (D. 18, temp. Tutankhamun).

¹⁷¹ E.g. Pay (RAVEN 2005, scene [16], pl. 26, 30, 158; D. 18, late); Maatmenet (RAVEN 2001-2002, pl. 29 [20]; stela from tomb of Ramose; D. 19); Hori (stela Leiden AP 50 [V. 57]; BOESER 1913,

p. 9 [30], pl. XX; RAVEN, STARING 2007, fig. on p. 10, p. 180, cat. 158; D. 19).

¹⁷² E.g. stela of Nehy (RAVEN 2005, scene [82], pl. 82; D. 18, late/D. 19, early).

¹⁷³ E.g. Chief goldsmith Amenemone (stela Cairo TN 10.6.24.8; OCKINGA 2004, scene [1], pl. 5, 55; D. 18, late); Amenma (stela Berlin 7320; GESSLER-LÖHR 2007a, pl. 7; D. 18, Thutmosis IV-Amenhotep III).

¹⁷⁴ E.g. Chief goldsmith Amenemone: OCKINGA 2004, pl. 13, 61 (Munich G1 298; D. 18, late), Roy; G. T. MARTIN 1991, fig. 122 (Berlin 7278; D. 18, late/D. 19, early).

¹⁷⁵ Sayempetref: Amsterdam, Allard Pierson Museum 8851 (ex-coll. W.A. VAN LEER (D. 19, early, temp. Seti I). Van Leer 1938, p. 30-31, no. 8**, pl. XVI; Janssen 1957, p. 17-19, no. 8**, pl. V; *KRI* I, p. 346-349; VAN HAARLEM,

SCHURLEER 1986, p. 35, 37, fig. 17; LUNSINGH SCHEURLEER 2009, p. 42-43 [Cat. 8]. All of these publications locate the tomb of Sayempetref at Abydos, while PM III², p. 716-717; G. T. MARTIN 1991, p. 201; MASQUELIER-LOORIUS 2013, p. 269, with n. 959, indicate Saqqara.

¹⁷⁶ One parallel at Thebes is presented in the tomb of the Vizier Ramose (TT 50, temp. Amenhotep III-Akhenaten). Two scenes present Ramose and Meryt-Ptah seated before an offering table. These would be the earliest representations of this position, at Thebes. See DAVIES 1941, pl. XII, XX. The same position of the hand can be observed in the 20th Dynasty tomb of Nakht-Amun (TT 341), inner room, east and south walls, both registers, each depicting Nakht-Amun and his wife Kemena, seated: DAVIES 1948, pl. XXVIII.

These gestures all differ slightly in their detail of execution. The earliest representation, in the tomb of Mery-Neith, shows Anuy placing her hand slightly below the armpit of her husband. All fingers are on his sleeve (fig. 5).¹⁷⁷ The possibly contemporary relief of an anonymous official shows his wife grasping her husband's arm somewhere between his elbow and wrist: four fingers clasp the arm and the thumb is positioned upwards.¹⁷⁸

In the tomb of Mery-Sekhmet (Bubastieion I.5), Iwy stands behind her husband while grasping him by his upper arm, directly under his armpit (fig. 6).¹⁷⁹ The fingers are positioned on his sleeve, thumb upwards.

One of the scenes from the tomb of Maya indicates a similar position for the hand of Meryt, fingers on the sleeve of Maya, thumb up.¹⁸⁰ As opposed to the previous examples, the couple is represented while seated. In the third scene from the tomb of Maya (standing), the position of the wife's hand differs (fig. 7). The right hand of Meryt rests on the tomb owner's bare arm and only her thumb and partially her index finger rest on her husband's pleated sleeve.¹⁸¹

Another representation, from the reign of Ramesses II and possibly of later date than Ptahmose, is that of the Overseer of the Treasury Amenemone (tomb ST 101).¹⁸² A relief from the central chapel of his tomb show him and his wife, the Chantress of Bastet *Mry.t-Pth*, seated in front of an offering table. Meryt-Ptah is seated "behind" her husband. She holds a large sistrum and lotus stems in her right hand, and grasps Amenemone by his upper arm, nearly under his armpit.

This specific iconographic feature is attested briefly during the late 18th Dynasty: reign of Tutankhamun to Horemheb. The example of Ptahmose is a relatively "late" attestation at the beginning of the 19th Dynasty.¹⁸³

Inehyt, wife of Ptahmose, grasps her husband with her right hand by his left upper arm. While doing so, her hand appears to be piercing through Ptahmose's pleated sleeve. This "incorrect" rendering is somewhat reminiscent of that on a family stela of the Scribe of the treasury of the Perfet God, Huy,¹⁸⁴ and a relief fragment from the Memphite tomb of the Chief of goldworkers of the temple of Men-Maat-Re (Seti I), Sayempetref.¹⁸⁵ On the stela, three women are depicted seated behind their respective husbands.¹⁸⁶ Their hands appear to

¹⁷⁷ RAVEN *et al.* 2001-2002, fig. 1; VAN WALSEM 2001, fig. 3; RAVEN, VAN WALSEM 2014, scene [29]. Note: these are the representations of statues of Mery-Neith and Anuy, standing on a sledge.

¹⁷⁸ Chicago, Field Museum 31289; G.T. MARTIN 1987, p. 11, pl. 5, 42 (provenance unknown; possibly Saqqara).

¹⁷⁹ ZIVIE 2000, fig. 5 (raised relief). Location tomb Bubastieion I.5; ZIVIE 2012, fig. 2.

¹⁸⁰ 1) G.T. MARTIN 2012, scene [30], pl. 24; 2) G.T. MARTIN 2012, scene [20], pl. 21, 88(2) (Liebieghaus St. P 425), probably south thickness of doorway between first court and statue room.

¹⁸¹ LD III, pl. 240a; G.T. MARTIN 1991, pl. VIII; G.T. MARTIN 2012, scene [30], pl. 24-25, 90.

¹⁸² GOHARY 1991b, pl. 56 (panel 2).

¹⁸³ While Zivie dates Mery-Sekhmet to the late 18th Dynasty, he may have lived well into the early 19th Dynasty (cf. BINDER 2008, p. 315 [112]).

¹⁸⁴ Stela Leiden AP 8 (V 26), ex-coll. d'Anastasi 1828, early 19th Dynasty; BOESER 1913, p. 4 [12], pl. III. The stela is of unknown provenance (possibly Abydos).

¹⁸⁵ N. 175, *supra*. Title: *hry nb.w n t' hw.t Mn-Ms'.t-R'*. Also compare to the rendering of the backrest of the chair on which Ipy is sitting. The outlines of that

backrest are visible through the seated tomb owner's sleeve (relief in private collection: PASQUALI, GESSLER-LÖHR 2011, p. 292 with n. 58, fig. 1).

¹⁸⁶ These couples are: the parents of Huy, the Royal scribe and Overseer of the double granary, Siese, and his wife, the Songstress of Atum, Tentiu-net (second register); Huy and his wife, the Lady of the house and Songstress of Atum, Mutnofret (third register); the Overseer of cattle, Mahu, and his wife, the Lady of the house Tasennefret (fifth register). The women almost seem to be "squeezing" the thin arms of their husbands. The same can be observed e.g. on the stela of Khaemipet

be piercing through their husbands' sleeves, and the artist even coloured their arm throughout, whereas these are actually situated behind the male's arm, and therefore not visible. On the relief fragment of Sayempetref, Neshay and her husband are depicted while seated, facing left. Sayempetref has lowered his left arm, holding a *brp*-sceptre and a folded napkin. Neshay rests her right hand on her husband's left arm. The artist attempted to naturalistically render her arm behind Sayempetref's sleeve, which takes the form of her arm. This results in a rather unusual representation, where the wife's arm almost appears to be piercing through the elbow-length pleated sleeve of Sayempetref.

To sum up, the specific iconographic details observed in the relief of Ptahmose, visible on the reveal of the doorway photographed by Devéria, have few parallels in the corpus of New Kingdom tombs at Saqqara. The naturalistic representation of two feet is observed only in reliefs dated to the late 18th Dynasty, Tutankhamun to Horemheb.

The double staff is more common, but restricted to holders of the highest offices. In tomb iconography at Saqqara, the double staff is attested from the reign of Amenhotep III to the early reign of Ramesses II, with a peak in the late 18th Dynasty.

The most distinguishing feature is the position of the wife's hand. It appears in the immediate post-Amarna period to the early 19th Dynasty and is observed in only six tombs.

When considering all parallels, there are two scenes that present a direct parallel for the composition of a standing tomb owner holding the double staff and the "lettuce" and *shym* sceptre, accompanied by his wife who grasps her husband by his arm below his armpit. These scenes are from the tombs of Maya and Mery-Sekhmet (fig. 6-7).¹⁸⁷ Both tombs were probably constructed around the same time. The composition of these scenes is identical and they have the additional smaller-scale figure in common. This composition may have developed from earlier scenes such as those observed in the tomb of Mery-Neith.¹⁸⁸ The contents of the associated texts differ. Maya's scene is positioned on the south reveal of the doorway leading from the statue room towards the inner courtyard, orientated towards the west. The scene in Mery-Sekhmet's tomb decorates the chapel of his rock-cut tomb, orientated towards the south.

Location of the Devéria doorway

In view of the position of the sun, and assuming the usual east-west orientation¹⁸⁹ of the tomb in question, the doorway photographed by Devéria must have been represented from the south-east. The doorway opens into a wide-open space. That space is confined by a mudbrick

from Qantir, temp. Ramesses II (Ägyptische Sammlung Tübingen 471: VON RECKLINGHAUSEN 2011, p. 106, Cat. 38). The woman's hand pierces through the man's sleeve, her thumb is positioned over his arm, and her fingers clasp around it. This appears as a later development of the position of the woman's hand as observed during the late 18th to early 19th Dynasty at Saqqara.

¹⁸⁷ Although the scene on the north wall of the tomb of Mery-Neith is also similar, it depicts not the deceased couple, but their statues (n. 177, *supra*).

¹⁸⁸ Closely related are scenes from the tombs of Pay and Aper-El. For Pay, see RAVEN 2005, scene [51], pl. 53 (without wife). Aper-El: ZIVIE 1988, pl. 14 (without both embrace and double staff).

¹⁸⁹ Note that the tomb of Tjaj (ST 211) has a north-south axis (TAWFIK 1991, fig. 1). There are usually no doorways to the north or south, although there are exceptions, e.g. in the tombs of Ramose (secondary doorway in north wall forecourt: MARTIN 2001, p. 2, pl. 1) and Tia (doorway in south wall second court: MARTIN 1997, pl. 1).

wall, the top of which can be discerned in the sand slope in the background. The doorway is narrowed by the doorjambs at the near (east) end, whereas the far (west) end is wider. The doorway might have originally been narrowed on both sides, implying an additional doorjamb is missing on the far-end.¹⁹⁰ The limestone blocks placed at a right angle to the doorjambs facing the observer form an important clue to determining where exactly the photograph was taken. These appear to be part of stone platforms similar to those observed in the tombs of Maya and Horemheb. The west end of their statue rooms – an architectural space attested at Saqqara only in these tombs – contain stone platforms that used to accommodate statues.¹⁹¹

As the reveal visible in the Devéria doorway should be situated on the north wall, Ptahmose and Inehyt are observed entering their tomb. The vertical inscription in front of the standing tomb owner (*supra*, I.13) confirms that hypothesis. The passage “Welcome to the west, may you unite with your place of eternity, your tomb of everlastingness [...]” indicates that this scene graphically represents the arrival of the couple at their tomb, on their way to the central cult-chapel located in the west.¹⁹² There is one close parallel for this passage, which is again found in Maya’s tomb. The vertical inscription immediately in front of the standing figure (fig. 7) reads: “Leaving his house for his tomb where the god receives his offerings (?)”.¹⁹³ This text makes explicitly clear that Maya and Meryt leave the world of the living and enter their tomb,¹⁹⁴ which is a movement in a westward direction. That movement is graphically emphasized by the figures’ orientation. I would like to propose a similar architectural setting for the Devéria doorway: the passage between the statue room and inner courtyard. The main scene would be on the north reveal showing the couple entering the inner sanctum of their funerary monument (fig. 8). The reveals appertaining to the doorway in the tomb of Maya have one broad column of deeply incised hieroglyphs with the titles and name of this official, which is similar to the Devéria doorway.¹⁹⁵ The question of what was depicted on the south reveal of this doorway remains open.

¹⁹⁰ Compare Maya: G.T. MARTIN 2012, pl. 1B; Horemheb: G.T. MARTIN 1989, pl. 6; Pay: RAVEN 2005.

¹⁹¹ Horemheb: G.T. MARTIN 1989, pl. 5; Maya: G.T. MARTIN 2012, pl. 1, 70 [2]. Note that small statue platforms are also present at the entrance to the central western chapel of the tomb of Maya: G.T. MARTIN 2012, p. 10, pl. 1, 77, 1.

¹⁹² Compare e.g. relief Hannover, Museum August Kestner 1935.200.186 (G.T. MARTIN 1987, p. 8-9 [5], pl. 3. Djuževa (2000, p. 82) on stylistic grounds tentatively attributes the block to the tomb of General Amenemone. The text “welcomes” the tomb owner

to *ḥ-mry*, “after a long [life]”. Ipuky of TT 181 (DAVIES 1925, pl. XVIII, entrance doorway, east thickness) also walks into his tomb, accompanied by a text welcoming him while holding a *mdw*-staff and *šbm*-sceptre.

¹⁹³ G.T. MARTIN 2012, p. 30, scene [30]. Note that this scene of entering is depicted in the north wall. The same orientation can be observed in the tomb of Tia (Chapel C), where scenes of entering and leaving are represented on the south and north wall of the doorway respectively (MARTIN 1997, scenes [88], [89], pl. 49-50).

¹⁹⁴ Compare the representations on the pillars and pilasters in the transverse hall of the tomb of Paser (TT 106, temp. Seti I-Ramesses II). The spells indicate different movements: to Rosetau, the netherworld (*r n ‘q pr.t m ḥtp r r-šꜣw*), to the world of the living (*r n pr.t m ḥrw*) and to see his house on earth (*r mꜣꜣ pr-zf tp-tꜣ*): SEYFRIED 1990, p. 345-347, pl. 57ac-d, 58a; PM I, 220 (106).

¹⁹⁵ G.T. MARTIN 2012, scenes [31], [32], pl. 25.

Second Devéria Photograph: the “Mur Rhoné”

The five adjoining relief decorated limestone revetment blocks (I.II) that were photographed *in situ* by Devéria depict the tomb owner (as *Ỉpꜣ*, short name for *Pth-ms*) standing in a papyrus boat (fig. 4). His son, grandson and possibly a daughter or second wife (see below) are with him. The scene may have been inspired by Old Kingdom *sšꜣ wꜣd*-scenes.¹⁹⁶ On the left, the fragments of two sub-registers are visible: catching birds with a clapnet and fishing with a dragnet.¹⁹⁷ Both activities are situated in the same marsh area. On the right, the lower half of three columns of text, each with different title sequences of Ptahmose, are preserved.

Berlandini already described this remarkable scene in detail.¹⁹⁸ Therefore, only some remarks on the iconography, style and location will be added here.

An Archaising Feature: Fishing and Fowling in the Papyrus Swamp

According to Hoffman,¹⁹⁹ an old motif is used here in order to represent a new and local religious concept: the veneration of Hathor. The rustling of the papyrus suggests a rite connected with the Hathor cult. Hathor depicted as a cow in the marshes can be observed on the stela of the Singer of Ptah, Mentuy.²⁰⁰ The hilltop monument of Khaemwaset, fourth son of Ramesses II, at Saqqara North provides a parallel for the marsh scene.²⁰¹ It depicts Khaemwaset, standing on a papyrus boat, facing a goddess. He presents an offering table, from which fish and lotus flowers hang down.²⁰² As with the “Mur Rhoné”, the boat is surrounded by fish – and a hippopotamus.

The relief representing the slaughtering of cattle as represented on a relief from the tomb of Prince Khaemwaset, is another example of the adaptation of a stylistically Old Kingdom scene in a New Kingdom tomb at Saqqara.²⁰³

¹⁹⁶ BERLANDINI 1982, p. 88. For a discussion of such scenes in Old Kingdom mastaba tombs, see e.g. MUNRO 1993, p. 95-118; ALTENMÜLLER 2002; WOODS 2008. The fragment of a similar scene originates from the tomb of the General Amenemone: Université de Strasbourg, Institut d'égyptologie 2439A, D. 18, temp. Horemheb (ANONYMOUS 1973, p. 37 [133], fig. 19; DJUŽEVA 2000, p. 77-98, Dok. 13, pl. 3.). The location of his Memphite tomb is unknown (cf. PM III², p. 701), but might have been situated in the New Kingdom cemetery north of the pyramid of Teti (LD Texte, I, p. 138: “Einzelne Steine im Dorfe Abusir verbaut”, reliefs Copenhagen, Carlsberg Glyptothek ÆIN 714-715; DJUŽEVA 2000, p. 83-84). On the motif as an adaptation of an Old Kingdom scene, see below.

¹⁹⁷ The fragment of a block depicting two men pulling ropes, found on

the surface above the tomb of Iniuiia (excav. nr. R 93-91; Schneider 2012, p. 100 [26d], fig. III.56, “Old Kingdom”) may just as well have formed part of an “archaising” New Kingdom scene. It would match the dragnet scene on the left-hand side of the “Mur Rhoné”. A block appropriated for decoration in the tomb of Maya proved to be reused from an Old Kingdom mastaba: part of a dragnet scene is still visible on the side adjacent to the surface re-cut for the image of Maya's stepmother Henutiunu (G.T. MARTIN 2012, scene [5], pl. 85).

¹⁹⁸ BERLANDINI 1982, p. 86-92.

¹⁹⁹ HOFMANN 2004, p. 145.

²⁰⁰ Avignon, musée Calvet A 24 (Saqqara, ex-coll. Perrot 1843; D. 19, temp. Ramesses II, first half): Berlandini-Keller 2011, fig. 4. Mentuy and his wife, the Songstress of Amun, Nefertari, present offerings and a libation to the Hathor cow. Both are separated by an

offering table. For an example (possibly) from Thebes, see e.g. Copenhagen, Carlsberg Glyptothek ÆIN 1553, stela fragment of Paser, Vizier of Seti I and Ramesses II: KOEFOED-PETERSEN 1948, p. 29, pl. 35.

²⁰¹ SAITO 2006, p. 180-186, fig. V-4-9; TAKAMIYA, KASHIWAGI, YOSHIMURA 2011, p. 408-409, fig. 5.

²⁰² As the block with the upper parts of their bodies is missing, it is not clear who presents and who receives the offerings. The excavators tentatively propose that Khaemwaset presents the offerings (TAKAMIYA, KASHIWAGI, YOSHIMURA 2011, p. 409).

²⁰³ Hannover, Museum August Kestner 1935.200.183; DRENKHAHN 1989, p. 115-117, fig. 38; HOFMANN 2004, p. 144-146 and fig. 169.

A third example of the archaizing use of an Old Kingdom motif in Memphite New Kingdom private tomb decoration, is the agricultural scene from the tomb of the High Priest of Ptah at Memphis, Mery-Ptah.²⁰⁴ Farmers are depicted on two sub-registers, ploughing with hoes and plow, while Mery-Ptah himself is sowing. The postures and clothing of the farmers are stylistically Old Kingdom, whereas Mery-Ptah is wearing a New Kingdom garment. Comparable archaizing agricultural scenes can be observed in the two lower registers of a relief slab from the tomb of Merymery.²⁰⁵ Mery-Ptah actively participates in the agricultural activities, which an Old Kingdom tomb owner would never do.²⁰⁶ Instead, he would be overseeing those activities, as is the case with Merymery. In both scenes, dialogues between the farmers are included.

The adaptation of pre-18th Dynasty tomb scenes in Ramesside private tombs is observed more frequently at Saqqara than at Thebes.²⁰⁷ According to Fr. Hofmann: “Hier (*i.e.* at Saqqara) leben in Ramessidengräbern Elemente des Alten Reiches wieder auf, ein Vorgang, der sich leicht damit erklären lässt, dass die Künstler an ihren Arbeitsstellen in der Nekropole von Saqqara unmittelbar mit bestem Relief konfrontiert waren, mit den Reliefs der umgebenden Mastabagräber des Alten Reiches”.²⁰⁸

A further interest in the Old Kingdom monuments at Saqqara is exemplified by the New Kingdom visitors' graffiti written or scratched on their walls and correctly identifying those monuments.²⁰⁹ At the same time, Old Kingdom mastaba tombs are demolished and their (decorated) limestone blocks are reused as building material in New Kingdom tombs.²¹⁰

²⁰⁴ Badisches Landesmuseum Karlsruhe H.1046 (D. 18, late, Tutankhamun-Horemheb): GESSLER-LÖHR 2007b, p. 32-36; 54-55, fig. 1.7. For the position of Mery-Ptah in the succession of High Priests of Ptah at Memphis, see RAEDLER 2011, p. 137 and table 1. Mery-Ptah was also High Priest at Heliopolis. I thank Beatrix Gessler-Löhr for notifying me of this relief and for sending me a copy of her article.

²⁰⁵ Custodian of the treasury of Memphis, D. 18, temp. Amenhotep III: Leiden, Rijksmuseum van Oudheden AP 6 (ex-coll. d'Anastasi 1828): BOESER 1911, p. 5-6, pl. XVIII; SCHNEIDER, RAVEN 1981, p. 96, fig. 84a.

²⁰⁶ GESSLER-LÖHR 2007b, p. 34, who convincingly rejects the interpretation of GAMER-WALLERT (1983, p. 108-111, with n. 4) of this scene as the Elysian Fields of Iaru (cf. Fields of Iaru in the tomb of Horemheb: G.T. MARTIN 1989, scene [117], p. 123-124, pl. 137, Bologna, Museo Civico 1885). Instead, she proposes that the artist copied a scene from a nearby Old Kingdom mastaba tomb.

²⁰⁷ PINO (2005, p. 95) noted that the representation of market scenes in

New Kingdom tombs at Thebes is unusual (only in TT 57, Khaemhat; TT 162, Kenamun; TT 217, Ipuy; TT 54, Huy and Kenro, and TT A4), and that it occurred more frequently in tombs of the Old Kingdom, especially at Saqqara. The style of the reliefs at Thebes is however not archaizing but genuinely New Kingdom.

²⁰⁸ HOFMANN 2004, p. 144-145. The same has been argued by Zivie (2000, p. 178) with reference to the artists responsible for the decoration in the tomb of Mery-Sekhmet (Bubastieion I.5), where Old Kingdom influence can be detected. For an earlier note, see MÁLEK 1992, p. 66-67 (“possible adoption of motifs from earlier tombs at Saqqâra”), who concluded “[...] no case of direct relationship between the decoration of New Kingdom chapels at Saqqâra and their predecessors can be demonstrated. The artists who decorated these tombs drew on their own training and knowledge and did not look for their inspiration to the earlier local ‘Memphite’ school of art”.

²⁰⁹ Cf. NAVRÁTILOVÁ 2007, p. 134-139, who noted a diachronic development

of the graffiti formulae, from predominantly “antiquarian” in the 18th Dynasty to “piety-oriented” in the Ramesside period.

²¹⁰ See e.g. the dyad of Maya and Meryt found in their tomb, the underside of which bears an Old Kingdom relief (G.T. MARTIN 2012, scene [59], p. 38-39, pl. 128,2). In the same tomb, an Old Kingdom relief block was re-carved with the scene of Henutiunu (see n. 197, *supra*). In shaft i of the tomb of Horemheb, Old Kingdom blocks, a sarcophagus, and blocks from the colonnade of Djoser were found (G.T. MARTIN 1989, p. 135-136, pl. 145, 158), and the foundation of the of the north wall of the forecourt contained 2nd Dynasty stone vessel fragments (east and west chambers of shaft 2005/1 in the forecourt of the tomb of Tia: ASTON 2011, p. 231). For notes on the physical and ideological contacts between the old and the new at Saqqara, see: MÁLEK 1992, and more recently: SNAPE 2011 (esp. p. 468-469).

Location of the “Mur Rhoné”

Let us now turn to the position of the “Mur Rhoné” photographed by Devéria in 1859. Málek proposed the north wall of one of the western chapels as the original position of these blocks.²¹¹ Van Dijk considered this hypothesis to be premature, pointing at the position of similar scenes on the north, east and south walls of the inner courtyard of the tomb of Maya.²¹² Greco proposed to situate the scene on the east end of the north wall of the tomb’s courtyard, arguing that “daily life” scenes are attested there in other tombs at Saqqara. Blocks Leiden AP 54 (I.5), Liebieghaus IN 1643 (I.6), and Cairo TN 25.6.24.6 (I.7) must have been positioned in its vicinity.²¹³ Greco rejected Málek’s hypothesis because of the reconstructed height of that wall to 309 cm, which is higher than any of the western chapels of New Kingdom tombs at Saqqara.²¹⁴ Instead, he suggested the eastern section of the north wall of the court. This indeed accords with similarly themed scenes on the north wall of Maya’s inner courtyard.²¹⁵

The “Mur Rhoné” photograph of Devéria as published by Berlandini appears to be cropped on the right-hand side. The prints kept at the Bibliothèque nationale and in the musée d’Orsay clearly indicate that this relief must be positioned on the left side of a doorway. Therefore, Greco’s reconstruction needs to be rejected as well.

To the right of the main scene, three text columns contain different titles of Ptahmose and each ends with his name. The doorjambs to the central chapel in the tomb of Maya provide a direct parallel for this setting.²¹⁶ The west wall of the inner court, to the left of the entrance to the central chapel, is therefore a likely candidate to position the “Mur Rhoné” (fig. 8). Alternatively, this scene can be reconstructed on the east wall of the inner court, if indeed it joins to the scene with boatmen in a tilting match (I.18). Then, the scene covers the wall between the doorway from statue chamber to the inner courtyard, and a chapel accessed from the court’s east wall.²¹⁷ As a consequence of this reconstruction, the revetment block visible in the doorway to the right of the “Mur Rhoné” can be identified as the Devéria doorway.

Regardless of the reconstruction, the blocks that have previously been joined to the “Mur Rhoné” must also be reconstructed on this wall. The lower section of Cairo TN 25.6.24.6 (I.7) contains the top of papyrus plants and a flying bird, which makes this the second, or middle register. Whether Liebieghaus IN 1643 (I.6) was indeed placed directly above, remains open for debate. Four superimposed registers are rarely observed in New Kingdom tombs at Saqqara, where three registers appear to be the standard. The head of the subsidiary figure in the lower

²¹¹ MÁLEK 1989, p. 134. His main arguments: the orientation of the hieroglyphs in the bandeau texts (outward direction), the tomb owner facing left (west) while adoring the gods, and the deceased couple facing right (east) in offering scenes.

²¹² VAN DIJK 1993, p. 152, n. 6.

²¹³ GRECO 2011, p. 198.

²¹⁴ However, compare tomb of Tia, where the walls of the enclosing peristyle of the inner courtyard are reconstructed to 3,235 m: FRAZER 1997, p. 9.

²¹⁵ Centre of wall: upper register (Cairo JE 43274c), Maya adoring enshrined Hathor cow [right] and offering bearers approaching the seated deceased couple [left]; lower register (Cairo 43274d), Maya inspecting the arrival of foreign captives and a herd of cattle (G.T. MARTIN 2012, p. 33-34, pl. 1, 29).

²¹⁶ G.T. MARTIN 2012, scenes [53], pl. 34. Also compare the tomb of Tia, west wall of inner courtyard, south doorjamb of antechapel B, with text in sunk

relief and a panel with the kneeling tomb owner beneath: G.T. MARTIN 1997, scene [64], pl. 38, 141. Columns on north doorjamb are lost.

²¹⁷ Chapels accessed from doorways in the east wall of the courtyard are present in the tombs of the Director of the Harim, Pay (RAVEN 2005, pl. 1; only north chapel made accessible), and the Steward of the temple of the Aten, Mery-Neith (RAVEN *et al.* 2001-2002, fig. 2b).

section of Liebieghaus IN 1643 may just as well adjoin yet another scene. On the north wall of the inner courtyard of Maya's tomb, one register shows the adoration of a Hathor cow in a barque.²¹⁸ The adjoining lower register has Maya supervising activities on two sub-registers, with scribes recording. A similar composition with the tomb owner supervising two sub-registers with each containing a seated scribe is found on the north wall of the chapel of Iniuiia, being the middle register.²¹⁹ Blocks Liebieghaus IN 1643 and Leiden AP 54 (I.5) might have been situated on the north wall of the inner courtyard, west section.

Late 18th Dynasty Artistic Tradition at Saqqara

The iconography of the Devéria doorway exhibits similarities with a limited number of tomb scenes of the immediate post-Amarna period. Hofmann already noted that the reliefs of Ptahmose are “Zeugnisse für einen Reliefstil der frühen Ramessidenzeit, zumindest einer richtung, die am Konventionellen festhält”.²²⁰ The parallels with the tomb of Maya are especially noteworthy. The statues of Meryt and Inehyt are also of comparable quality craftsmanship and execution. At least part of the tomb of Ptahmose was executed in the same “artistic tradition”. The mudbrick core with limestone revetment has been noted earlier as being characteristic for the late 18th Dynasty. The statue room, if indeed here identified correctly, is a feature seen only in the tombs of Maya and Horemheb. The *djed*-pillars, however, are a Ramesside novelty. The tomb of Ptahmose should therefore be considered as a transitional type, the like of which has so far not been attested archaeologically at Saqqara.

The sculptor responsible for the tomb of Maya might be identified in a scene of that tomb. Van Dijk pointed out that the *im.y-r k3.t m s.t nbh*, “Overseer of works in the Place of Eternity”, Userhat, may possibly be the same man as the well known *hr.y t3.y-md3.t n nb t3.wy Wsr-h3.t*, “Chief sculptor of the Lord of the Two Lands” with the same name.²²¹ The sculptor Userhat is attested by a number of architectural elements from his Abydos memorial chapel,²²² by a

²¹⁸ G.T. MARTIN 2012, scenes [37], [38] (Cairo JE 4327a-e), pl. 29.

²¹⁹ SCHNEIDER 2012, scene [22b] (Cairo TN 3.7.24.13), fig. III.38. Lower register: scene [22a] (TN 25.6.24.7), fig. III.37: “Iniuiia supervising the unloading of amphorae from boats”.

²²⁰ HOFMANN 2004, p. 101. He indicates that the garment worn by Ptahmose on the *djed*-pillars (III.1-4) occurs at Thebes only at the end of the 19th Dynasty: “Saqqara war Theben nicht nur deutlich voraus, sondern es war stilbildend” (HOFMANN 2004, p. 105).

²²¹ VAN DIJK 1995, p. 31. *H3.t-i3y* is the short form of his name; *Pn-yw* (“he of Iia”) is a patronymic. Userhat's father

Î3 held the title *hr.y t3.y-md3.t*, while his brother Sa held office as “Chief sculptor of the Lord of the Two Lands”, and “Chief craftsman in the Mansion of Gold of Ptah”. The scene is in the inner courtyard, south wall: Userhat in front of a kiosk with offerings, pouring liquid from a vase as part of the funerary ceremonies: LD III, p. 242b [upper left figure]. The lower register depicts the transportation of a chest and kneeling statue. This relief (Berlin 2088) was much damaged during World War II. The scene with Userhat had probably been destroyed during the 19th c. and only small fragments were recovered during excavation (VAN DIJK 1995, p. 31, fig. 1; G.T. MARTIN 2012, scene [41], pl. 32). His title could refer to

an assignment in the Valley of the Kings (VAN DIJK 1995, p. 33; WILLEMS 1998, p. 243). His other title in that scene: *hr.y smn gnw.t*, “Chief of the annals/of the establishment of the records”.

²²² GUKSCH 1983, p. 23-24. Stela with biographical text, Leiden AP 12 (V. 1): BOESER 1913, p. 1-2, pl. I; see WILLEMS 1998; FROOD 2007, p. 117-129 [19A, B]; door frame, Leiden AP 14: BOESER 1911, p. 9, pl. XXXIII-XXXVI; the lintel is almost identical (in layout, iconography and textual content) to a lintel belonging to the Table scribe Kha, presumably also from Abydos (FROOD 2007, p. 118).

stela from Gizeh,²²³ and a *shabti* from the Serapeum.²²⁴ Van Dijk added a statue base from Saqqara.²²⁵ Willems identified Userhat as the owner of house T34.1 in the North Suburb of Tell el-Amarna.²²⁶ Userhat's career reached its apex in the late 18th Dynasty, during the period of restoration that started with the reign of Tutankhamun.²²⁷ This campaign was led by his superior, the Overseer of the treasury Maya.²²⁸ Another craftsman perhaps named in the tomb of Maya is the Chief goldsmith Amenemone.²²⁹

Maya may have started his career during the reign of Akhenaten or even Amenhotep III²³⁰ and might perhaps be identified as the owner of South Tomb no. 14 at Amarna.²³¹ Construction work on his Memphite tomb started under Tutankhamun and his funeral probably took place in year 9 of Horemheb.²³²

²²³ Cairo JE 72269; HASSAN 1953, p. 363, fig. 199 [stela no. 21]; Chr. ZIVIE 1976, p. 189-190 [NE 51]: stela from the temenos of the Great Sphinx, with Seti I kneeling in front of the Sphinx. VAN DIJK (1995, p. 33-34) indicates that this may not be the same man as the sculptor attested by the Leiden monuments, due to the "inferior" quality of the Gizeh stela.

²²⁴ KRI II, p. 369. To be associated with the Apis burial of either year 16 or 30 of Ramesses II (*Caveau 8*; Mariette room G). FROOD (2007, p. 117) agrees with VAN DIJK (1995, p. 33-34) that the Gizeh stela and Serapeum *shabti* might belong to another Userhat. A positive identification would imply that Userhat was in his 70s to 80s when he dedicated the *shabti*. Willems (1998, p. 232 with n. 5) rejects the identification of both stela and *shabti*, drawing on the problems caused by the "long" reign of Horemheb as discussed by VON BECKERATH (1995, p. 38-39: "at least 26 years"). However, new evidence on the reign of Horemheb (on wine jar labels from KV 57), points at year 14 being his highest recorded regnal year (VAN DIJK 2008). The burial of Horemheb then would have taken place at the latest at the beginning of year 15. Thus, the supposed age of Userhat need not be a problem for attributing these monuments to the same man.

²²⁵ VAN DIJK 1995, p. 32; MARIETTE 1872, p. 26, pl. 77j.

²²⁶ WILLEMS 1998, p. 240-241: PM IV, p. 200; FRANKFORT, PENDLEBURY 1933, p. 109, pl. XXIII[4]; LOHWASSER 2008; KEMP 2012, p. 75, 233, 242, 292, fig. 7.3-4, pl. XXV, XXX. The owner is named as the *im.y-r k3.t mb-ib n(y) nb 3.wy*,

"Overseer of works, Confidant of the Lord of the Two Lands", Hatiay. Pendlebury (1931, p. 237) notes that his tomb was known at Thebes, without reference to a TT-number.

²²⁷ VAN DIJK (1995, p. 32-33) emphasizes that the discourse in the text of stela Leiden AP 12 has close similarities with the autobiographical texts found in the private tombs at Amarna, and those of the immediate post-Amarna period at Saqqara (e.g. Maya, cf. GUKSCH 1994, p. 28-31). The statues of deities mentioned in the text are probably those produced to replace the statues destroyed during the reign of Akhenaten. The place names are concentrated mainly in Middle Egypt and south of Thebes (WILLEMS 1998, p. 232): the areas most heavily affected by Akhenaten's reforms. The Memphite area seems to have suffered less (e.g. HAYS 2008-2009, p. 15 with n. 15). WILLEMS (1998, p. 242 with n. 35) further points to the fact that important parts of the temple of Thoth at Hermopolis were built by Horemheb: Hatiay may have been overseeing these building activities—largely constructed with re-used *talatat*-blocks from Akhetaten—from his surprisingly well preserved house at Amarna.

²²⁸ Cf. restoration stela of Tutankhamun: Cairo JE 34183 (*Urk.* IV, p. 2025-2032), and the autobiographical text in the pylon gateway, south reveal, of Maya's tomb (FROOD 2007, p. 141-143 [23]; G.T. MARTIN 2012, p. 20: "I was one who carried out the plans of the king of my time and did not neglect what he had commanded [to make splendid (?)] the temples, in fashioning the images of the gods, their [rituals] being under my care".

²²⁹ OCKINGA 2000, p. 123. His title: *idnw (n) n3 n hmu.w pr.w hd n.y pr.w 3*, "Deputy of these craftsmen of the treasury of Pharaoh". His son, Ptahmose, might also be present (suggestion in OCKINGA 2000, p. 200): the *ss 3'.t n(y) p3 im.y-r pr.wy-hd*, "Letter writer of the overseer of the treasury". It is doubtful whether the Goldsmith Amenemone lived to see the reign of Horemheb (OCKINGA 2004, p. 20).

²³⁰ VAN DIJK 1993, p. 76 with n. 41: perhaps the same man as the Royal scribe May appearing in a number of hieratic dockets from the palace of Amenhotep III at Malqata (dated Year 34).

²³¹ Titles: Fan-bearer on the right hand of the king, Royal scribe, Scribe of recruits, Steward of the house of Sehetep-Aten, Steward of the house of Waena in Heliopolis, Overseer of cattle of the house of Ra in Heliopolis, Overseer of all the works of the king, General of the Lord of the Two Lands (DAVIES 1908, pl. IV). For the titles of Maya in his tomb at Saqqara, see G.T. MARTIN 2012, p. 60-62, with only few parallels to the titles of May at Amarna. On the owners of tombs possibly both at Amarna and at Memphis, see: SALVOLDI 2008.

²³² VAN DIJK 1993, p. 76-79: a fragmentary hieratic docket (referring to "fresh fat") found in the subterranean chambers of his tomb mentions "regnal year 9". His latest recorded official duty is related to the restoration of the burial of Thutmose IV (KV 43, chamber I, graffito dated regnal year 8 of Horemheb). Maya's tomb remained unfinished.

Ptahmose probably started his career at the time of Seti I. He could have been in office as Mayor as early as year 2 of that king, which is just nine years after the burial of Maya.²³³ It is hypothetically possible that the same sculptor(s) working on the tomb of Maya was/were also involved in the decoration of Ptahmose's tomb. As Overseer of all works, Ptahmose would have been the direct superior of those working on his funerary monument.

Another tomb of an official who started his career in the time of Seti I, and who constructed his tomb in the first half of the reign of Ramesses II, is Tia, the brother-in-law of that king. He constructed his funerary monument in between the earlier superstructures of Maya and Horemheb. According to Van Dijk, the tomb was decorated towards the end of the second decade of his reign²³⁴. The reliefs are reminiscent of a more advanced Ramesside style when compared to the reliefs of Ptahmose. According to Zivie relief decoration in the Ramesside tomb of Netjerwymes/Nemtymes seems to be inspired by late 18th Dynasty funerary monuments, such as the Overseer of the treasury Maya.²³⁵ The style is more similar to Tia—with slightly more elongated figures—then to Ptahmose.²³⁶

There are strong indications that the start of the construction of the tomb of Ptahmose has to be dated to the late 18th Dynasty. In the style of the different reliefs we can observe the passage of time into the early Ramesside period. All reliefs photographed by Devéria are unfortunately no longer available and a proper iconographic analysis certainly requires the study of the original decoration. It is hoped that the ongoing excavations of this tomb will yield more reliefs to accommodate a more detailed study.

Ptahmose and his Family

The various elements from the tomb of Ptahmose enable the reconstruction of a large part of his family. No relief currently at our disposal reveals anything of his descent. This may seem odd for someone of his rank and stature. The 18th Dynasty Memphite Mayor Beseau succeeded his father Herunefer in office,²³⁷ but no such filiation can be established for the

²³³ Neferhotep (PM III², p. 572, 755) served as Mayor before Ptahmose, at least until year 2 of Seti I. He is mentioned in the administrative accounts dated to Seti I: SPIEGELBERG 1896, p. 15-16, no. V, pl. V-VI; P. Bibliothèque Nationale, Paris, pBN. 206: year 2, fourth month of *šmw* (harvest), day 23 (KRI I, p. 244,16), and first month *ḏbt*, day 7 (KRI I, p. 245,14); and SPIEGELBERG 1896, p. 14, nr. IV, pl. IV; pBN. 205a: year 2, fourth month of *ḏbt* (inundation), day 7 (KRI I, p. 260,10). The nine years are calculated based on a reign of 14 years for Horemheb (VAN DIJK 2008), and 2 years for Ramesses I (ZIVIE 1984, col. 104).

²³⁴ VAN DIJK 1993, p. 102.

²³⁵ Bubastieion I.16, partly rock-cut, partly freestanding, second decade

Ramesses II. See ZIVIE 2003, p. 120, fig. on p. 121, 125, 129; LECLANT, CLERC 1998, pl. XX (12); HOFMANN 2004, p. 105, with fig. 128. The closest parallel for his *djed*-pillar are those of Ptahmose. The reliefs on the limestone revetment of the free-standing part of the tomb are stylistically similar to the tomb of Tia, although the human figures are less elongated. Further note that the reliefs are all in sunk relief.

²³⁶ For an iconographic study of selected reliefs from the tombs of Ptahmose and Tia, see HOFMANN 2004, p. 101-106. Also compare to reliefs from the tomb of the High Priest of Ptah Iy-iry, where the figures are even more elongated (D. 19, temp. Sety II: ANTHES 1965, p. 79-85, fig. 7-8, pls. 27[a], 28, 29[a]; HOFMANN 2004, fig. 129).

²³⁷ Stela Leiden AES 7: BOESER 1913, p. 2 [4], pl. VIII; GESSLER-LÖHR 1997, p. 31-34, pl. I. Note that HELCK 1975, col. 878 and MÁLEK 1987, p. 136, n. 75, read the name of the father as *Pruw-nfr*. The succession from father to son in office of Mayor has also been attested at Thebes (*ḥ. ty-ꜥ m niw.t rsy(.t)*): Paser and his son Haunefer (HELCK 1958, p. 527-528, nos. 11 and 12; D. 19, second half to year 2 of Merenptah). Another son of Paser is the Great steward of the Lord of the Two Lands in Thebes, Nebsumenu (TT 183; also featuring in TT 16 of the Prophet of Amenhotep I, Panehsy: KRI III, p. 398,13).

other holders of that office during the New Kingdom. It is however not so uncommon for people of an undistinguished origin to rise to prominence. The Overseer of the treasury Tia is a case in point,²³⁸ and the Chief steward of Memphis Amenhotep Huy was also descended from a “humble” background.²³⁹

Ptahmose (fig. 9) seems to have had at least one wife: Inehyt, the *nb.t pr, šm'.yt n.t nb.t n.t nb.t rry.t*, “Lady of the house and Songstress of the Lady of the Southern Sycamore” (*i.e.* the specific Memphite form of Hathor).²⁴⁰ She has two statues of her own—Walters Art Museum 22.106 (II.1) and Matsuoka Museum of Art 568 (II.2)—and shares dyad Cairo JE 41532 (II.5) with her husband. She also features on relief Leiden AP 54 (I.5) and probably on the Devéria doorway (I.13). A lady called *Mw.t-nfr(.t)* is identified as *nb.t* on the “Mur Rhoné” (I.11). Whether this woman is his daughter or his second wife—as *nb.t [pr]*—is unclear.²⁴¹

That Ptahmose—short name *ꜥꜣ* on the “Mur Rhoné”—must have reached a respectable age can be deduced from the fact that his grandson, the *w' b sꜣ n(.y) sꜣ=f*, *wab*-priest, the son of his son, Ptahmose, is also depicted on the “Mur Rhoné”.

Relief Leiden AP 54 shows five children. All are seated on the right-hand side of the scene. The two sons bear titles: Wesy is a God’s Father and Chief *wab*-priest in the house of Ptah;²⁴² Iia is also *wab*-priest of Ptah. If indeed Wesy was in office during the reign of Seti I, as has been tentatively suggested by Gessler-Löhr,²⁴³ then Ptahmose could have acquired a prominent position already during the late 18th Dynasty.

The “Mur Rhoné” introduces another son, the Chief of the stables of the residence, named Ptahmose.²⁴⁴ It also mentions his grandson, the *wab*-priest Ptahmose, presumably a son of the Chief of the stables with the same name.

Another man named Ptahmose, “Scribe in the temple of the house of Ptah”, appears on relief Cairo TN 25.6.24.6 (I.7). His relation to Ptahmose is not indicated. Berlandini (1982, p. 94) noted that this person has one title in common with the grandson of Ptahmose on the “Mur Rhoné”.²⁴⁵ A more likely candidate is the *sꜣ n(.y) hꜣw.t-ntr m pr Pth*, Ptahmose, on relief

²³⁸ VAN DIJK 1993, p. 91.

²³⁹ His father was the *sꜣb* Heby (pyramidion Leiden AM 6), and on statue Oxford, Ashmolean Museum 1913.163, he indicates that the king promoted him to be Chief steward “on account of [his] excellent demeanour” (cf. HAYES 1938, p. 21).

²⁴⁰ BERLANDINI 1981; BERLANDINI 1983; PASQUALI 2011, p. 83-86, with n. 269 (“Hathor, maîtresse du Sycamore-dusud”); ASSEM 2012.

²⁴¹ Note that a Lady of the house Mutnofret is indicated as the mother of the God’s Father in the temple of Ptah, Ptahmose, on statue Leiden AST 23. His sister (*i.e.* wife) is called Tamit and they have a daughter named Nafy and a son named Yuyu, the *hꜣr.y w' b n Pth*, “Chief *wab*-priest of Ptah”: BOESER 1912, p. 10-II [24].

²⁴² See also VERNUS 1969, p. 96 [E], Ptahmose incorrectly indicated as High Priest. Also GESSLER-LÖHR 2012, p. 185, with n. 161 and table 2. The descendants of the High priest of Ptah, Ptahemhat-Ty, were also God’s father in the temple of Ptah, temp. Tutankhamun to Seti I: his son Hatiay, and his grandson Ty (son of Hatiay), Amenemhab and NN (sons of Say). For the title *it-ntr*, see e.g. Gnirs 1996, p. 95-97.

²⁴³ GESSLER-LÖHR 2012, p. 185.

²⁴⁴ AL-AYEDI 2006, p. 371-372 [1251] (Stable master of the residence); also in the tomb of the Mayor of Thebes (*hꜣ.ty-ꜣ n nꜣw.t šm'.w*) Paser (SCHOTT 1957, p. 7, pl. D): male sitting behind the deceased couple, *Pꜣ-sr* and his wife *Tty*, designated as “her son”, named *Pꜣ///*; and an officiant before the deceased couple Ry, Head of bowmen and Overseer of

horses, and his wife, the Lady of the house and Songstress of Amun-Re, Maia: the *hꜣr.y-ib(.w)* (without further specification; their son?) is called *M'z*. The block (Berlin 7278) of *Ry* is from his tomb at Saqqara, dated to the late 18th to early 19th Dynasty. It was acquired in 1828 from the Passalacqua collection (PM III², p. 715-716; ROEDER 1924, II, p. 181; G.T. MARTIN 1987, p. 20-21, pl. 15 [42]). Also *hꜣr.y ihw n hꜣnw* on stela BM EA 154 (Hori, as brother of Wennefer; D. 19, late, ex-coll. d’Athanasia 1845); another Hori, on the stela of Hori, the Overseer of the fields of the Lord of the Two Lands (BM EA 132: James 1970, p. 58, pl. XLV [1], D. 19; provenance and acquisition unknown [Thebes?]).

²⁴⁵ BERLANDINI 1982, p. 94.

Florence 2557 (I.4), who is indicated without filiation. Relief Florence 2557 is divided in two registers. Each register depicts offering bearers approaching the seated deceased. In the upper register, four people are seated: one man and three women. Three male and two female offering bearers are approaching. The upper part of the scene, which must have contained the inscriptions, is lost. Much of the lower register is preserved. On the left side, a deceased couple is seated in front of an offering table. The name and titles of the man are given as *š n(.y) ḥw.t-nṯr m pr Ptḥ Ptḥ-ms*. This is clearly not the tomb owner, but probably his son, the same man depicted in the Cairo relief (I.7). Since Ptahmose is not mentioned as one of the sons on the Leiden relief (I.5), he was probably the eldest son, who had an active role in the funerary ceremonies. As such he was probably standing to the right of the deceased couple, on a block once adjoining Leiden AP 54 on the right. On Florence 2557, one male and five female offering bearers are approaching from the right and an additional two women are seated on the extreme right side of the scene. These figures are identified with name, title and filiation, being sons and daughters of the son of the mayor Ptahmose.²⁴⁶ The male figure is the *wab*-priest in the temple of Ptah, Hori. Two females are named Inehyt, although their spelling differs. One additional female figure, sitting on the right, is designated not as a daughter, but as the *mn'.t n(.yt) Ḥnw-nḥ.t*, “the Nurse of Inehyt”, named Nafmentu. A daughter Inehyt is depicted sitting in the lower subregister. I would like to propose the family tree indicated below (fig. 9). The overview of titles of the sons and grandsons of the mayor Ptahmose, indicates they were all granted a position in the temple of Ptah at Memphis.²⁴⁷ Unlike their (grand)father, they held not administrative, but priestly titles.

Titles and Epithets of Ptahmose in his Memphite Tomb²⁴⁸

From the data available it is difficult to sketch the early career of Ptahmose. The title Royal scribe generally seems to be the starting point in the career of every high ranking official. This education provided access to wide-ranging positions in the state administration. Successive Stewards of the contemporaneous Theban Ramesseum were drawn from the ranks of the military,²⁴⁹ and therefore it is noteworthy that Ptahmose had been active in the civil administration throughout his career. The majority of his titles connect him with the temple of Ptah at Memphis and it is likely that this is where he started. As Steward or Majordomus Ptahmose was responsible for the day-to-day administration of this institution. He had control

²⁴⁶ This interpretation is *pace* e.g. GRECO 2011b, p. 197.

²⁴⁷ Note that one High Priest of Ptah named Hori (II) was the son of a Ptahmose: MAYSTRE 1992, p. 142, 287 [88]; DARESSY 1889, p. 81, nr. XXIV (limestone column from Mit Rahina, Cairo TN 20.1.25.4).

²⁴⁸ This paragraph presents only a brief overview of the titles. In a forthcoming

article (STARING 2015) I will discuss the position of the Mayor of Memphis at the start of the 19th Dynasty into more detail. That contribution also seeks to analyse the wider administration of the city and temple and its changes from the late 18th Dynasty into the early Rameside period.

²⁴⁹ These men include the General Iurokhy/Urhiya (LS 25) and his son Yupa,

the General and Commander of the troops Ramessesnakht, and the Royal herald of His Majesty Amenemone (ST 101). The Steward of the Lord of the Two Lands Horemheb had a non-military career (PM III², p. 667-668, KR/ III, p. 187-191).

over the treasury of the Lord of Truth, a key financial position. Directly related to that office is that of Overseer of the granary, controlling the temple's prime agricultural income. Ptahmose must have been a successful official already during the reign of Seti I, as he was appointed Steward in the temple "Beneficial-is-Seti-Merenptah".²⁵⁰ He was subsequently appointed as the Chief steward of the Memphite memorial temple of Ramesses II. At the beginning of the 19th Dynasty the temple of Ptah witnessed considerable enlargements. Ptahmose's titles indicate that he was awarded a prominent position in these grand construction works.²⁵¹ He was Overseer of the troops (*i.e.* workforce) in the house of Ptah, and Overseer of works on all monuments of His Majesty, specifically in Hutkaptah.²⁵² The position of Mayor was traditionally concerned with the control of agriculture to ensure a steady food supply for the local population, the collection of taxes, and the management of the granaries, and this official was often commissioned with the support of local temples.²⁵³ His high rank assured him a position within the inner circle (*šn.yt*) of the king.²⁵⁴ His honorary titles included those of Chief [amongst] the courtiers, Eyes of the king in the house of Ptah, Mouth that appeases in Hutkaptah, and Vigilant administrator of the Lord of the Two Lands. Ptahmose did not hold any proper priestly titles, although he was One greatly loved by the gods, Lords of White Walls, and Guardian of the secrets of the temple of Ptah. The *ḥ3.ty-ꜥ*, "Mayor", and *im.y-r pr*, "Steward", appear to have previously been two separate offices.²⁵⁵ The fact that Ptahmose held two of the foremost positions in the civil administration of Memphis, and that he was "Chief steward in the temple of Ptah", including the estate beyond the temple walls (*ḥ3 inb.w Ptḥ*), may explain why the title of "Mayor" was changed into that of "Great Mayor" (*ḥ3.ty-ꜥ wr*).²⁵⁶ During his career Ptahmose was able to accumulate the impressive number of (at least) 52 titles. At Saqqara, that number is surpassed only by the Overseer of the treasury Maya and the Generalissimo Horemheb, both of the late 18th Dynasty (temp. Tutankhamun).²⁵⁷ After his death, a selection of his duties were distributed to a number of officials. The Mayorship and the supervisory duties over the construction works in the temple of Ptah were transferred to Amenhotep Huy,²⁵⁸ the civil administration of the temple and Ramesses' memorial temple were taken up by Nebnefer,²⁵⁹ and Netjerwymes became the Chief steward of Memphis.²⁶⁰

²⁵⁰ Possibly the great colonnade hall in the temple of Ptah at Memphis, later renamed as "Beneficial is Ramesses-Meryamun in the house of Ptah": KITCHEN 1991, p. 89; BRAND 2000, p. 146.

²⁵¹ Another prominent official who has been connected with the enlargement of the temple is the fourth son of Ramesses II, the High Priest of Ptah at Memphis, Khaemwaset: e.g. GOMÀÀ 1973, p. 34-35.

²⁵² *Hwt-k3-Ptḥ* was the name of the main cult centre of Memphis, but from the New Kingdom onwards it was also used to refer to the metropolitan area or

specific quarters and temple enclosures in the city (cf. JEFFREYS 2001, p. 373).

²⁵³ VAN DEN BOORN 1988, p. 243. Compare also: G.T. MARTIN 1971, p. 81 (index) and WEGNER 2001.

²⁵⁴ Cf. RAEDLER 2009; RAEDLER 2012.

²⁵⁵ Compare the "Berlin Trauerrelief", Ägyptisches Museum 12411 (PM III², p. 711-712; ROEDER 1924, II, p. 179-180; WILDUNG, REITER, ZORN 2010, fig. 100), depicting the funeral procession for the High Priest of Ptah, Ptahemhaty, during the reign of Tutankhamun. The cortege is composed of the highest ranking officials of late 18th Dynasty Memphis.

²⁵⁶ Málek (1987, p. 136) considered this an "artificially inflated titulary".

²⁵⁷ Compare G.T. MARTIN 1989, p. 171-174; G.T. MARTIN 2012, p. 60-62.

²⁵⁸ PM III², p. 770, 847. He is usually considered the predecessor in office to Ptahmose (e.g. GRECO 2011b, p. 197; PASQUALI 2012, p. 148).

²⁵⁹ Attested in the tombs of his sons Huynefer (ST 217) and Mahu (ST 218): TAWFIK 1991; GOHARY 2009; GOHARY 2010.

²⁶⁰ Tomb: Bubastieion I.16: LÉCLANT, CLERC 1998, p. 349, pl. XX (12); ZIVIE 2000, p. 179-180; ZIVIE 2003.

As I hope to have demonstrated in this article, the “new” photograph of Devéria, which captures a “lost” doorway in the recently rediscovered tomb of Ptahmose at Saqqara, has yielded new information on the architectural development of tombs and iconographic features of tomb-decoration at Saqqara during the transition from the 18th to 19th Dynasty. This study also opens up a next stage of analysis, as well as new directions for research. The newly compiled list of titles forms the basis for a forthcoming article on the administration of Memphis (both town and temple) during the early Ramesside period. More photographs taken by Devéria, capturing tombs from the same period, allow for a wider study of tomb development at Saqqara, as well as the development of the necropolis as a whole. To the present date, the mutual coherence of tombs within this cemetery is not well understood.²⁶¹ It is hoped that the present article has contributed at least a little towards a better understanding of the New Kingdom necropolis at Saqqara.

A. Related to the King, Royal Court, and Government (incl. honorific)	
<i>ꜥḥ n nbꜥf</i>	III.1
<i>ir.y-rd.wyꜥf</i>	I.8
<i>ir.ty n(.y) ns.w.t ꜥnb.wy bity</i>	I.5
<i>ir.ty n(.y) ns.w.t m pr Ptḥ</i>	III.5
<i>ir.y-pꜥ.t</i>	I.1-5, I.7, I.11, I.15 (1-4), I.17 (1-4); II.5; III.1-6
<i>ḳꜣ ns mi.t mbꜣ.t</i>	I.8
<i>wꜥ mnḥ n ntr nfr</i>	I.14
<i>biꜣ.tꜥf iqr rdi mr.w.tꜥf</i>	I.8
<i>mr(.y) nb ꜣ.wy</i>	I.5, III.4
<i>mrr.ty ꜣ n ntr nfr</i>	I.2, I.5
<i>mb-ib ꜣ n ntr nfr</i>	III.1
<i>[ns/r] shrr m ḥw.t-kꜣ-Ptḥ</i>	I.14
<i>ḥꜣ.ty-ꜥ</i>	I.1-5, I.11, 15 (1-4), 17 (1-3); II.5; III.1-5
<i>ḥꜥꜥtw [n sḏm] ḥrwꜥf</i>	III.1
<i>ḥr.y tp wr.w m inb(.w)-ḥḏ</i>	I.1
<i>ḥr[.y tp m] šny.t</i>	I.14
<i>ḥrp rs-tp n(.y) nb ꜣ.wy</i>	III.2
<i>smr wꜥ.ty</i>	I.1, I.5
<i>sr</i>	I.14
<i>sḏꜣw.ty bi.ty</i>	I.5, 9-10, 18; III.4

TABLE 4. List of titles of Ptahmose as attested on reliefs, statues, stelae and architectural elements from his tomb at Saqqara

²⁶¹ On this problem, see RAVEN 2000, p. 134-138.

B. General Administration	
Temple of Ptah	
<i>im.y-r pr</i>	I.5; II.6; III.3-4; V.1; VII.1-2
<i>im.y-r pr wr</i>	I.5; III.5
<i>im.y-r pr wr m pr Pth</i>	I.4-5, II, 14; III.1-5
<i>im.y-r pr m [tɜ] hwt R'-ms-s(w) mry-Imn m pr Pth</i>	III.6-7
<i>im.y-r pr wr m tɜ hwt R'-ms-s(w) mry-Imn m pr Pth</i>	I.2, II
<i>im.y-r pr wr n(y) Pth</i>	I.1; II.6; III.2; IV.1
<i>im.y-r pr m hwt ntr ɜh-Sthj-mr-n-Pth m pr Pth</i>	III.6
<i>im.y-r pr (n.y) Pth</i>	I.17A; II.3; 5; II.3-4
<i>im.y-r pr n(y) pr Pth hɜ inb.w Pth</i>	I.12
<i>im.y-r pr n(y) nb mɜ'.t</i>	I.1, 3, 5, 9
Treasury	
<i>im.y-r pr hɔ</i>	I.5; III.7
<i>im.y-r pr-hɔ n(y) nb mɜ'.t</i>	I.17 (3)
Granary	
<i>im.y-r snw.ty</i>	III.7
<i>im.y-r snw.ty n(y) nb mɜ'.t</i>	I.15 (4)
<i>im.y-r snw.ty n(y) nb-nhɔ</i>	I.11
Mayorship	
<i>hɜ.ty-ɛ wr</i>	I.11; II.6; IV.2
<i>hɜ.ty-ɛ wr m inb(.w) hɔ</i>	I.4-5, II; III.1-2, 5
<i>hɜ.ty-ɛ wr m hwt-kɜ-Pth</i>	III.4
<i>hɜ.ty-ɛ m inb.w-hɔ</i>	I.3; II.6
<i>hɜ.ty-ɛ hɜ inb.w</i>	II.6
<i>hɜ.ty-ɛ hɜ inb.w n(w) Pth</i>	I.17 (4)
C. Scribal	
<i>sš nsw.t</i>	I.4-5, 7, II-12, 14, 15 (3-4), 17 (1); II.4-6; III.1-5, 7; IV.2-3; V.1; VII.1-2
<i>sš nsw.t mɜ' mr(y)ɛf</i>	I.2
D. Public Works, Crafts	
<i>im.y-r mɜ' m pr Pth</i>	I.15 (1), 17 (2)
<i>im.y-r mɜ' wr m pr Pth</i>	I.5, II; III.5
<i>im.y-r kɜ.wt</i>	I.10
<i>im.y-r kɜ.wt m mn.w nb(.w) n(y) nb tɜ.wy(?)</i>	I.8
<i>im.y-r kɜ.wt m mn.w nb(.w) n(y) nsw</i>	I.12
<i>im.y-r kɜ.wt m mn.w nb n(y) hmɛf</i>	III.1
<i>im.y-r kɜ.wt m mn.w nb(.w) n(y) hmɛf m hwt-kɜ-Pth</i>	I.3, II.6
E. Sacerdotal	
<i>mrr.ty ɛ n ntr.w nb.w inb(.w)-hɔ</i>	III.3
<i>hr.y-sšɜ n(y) hwt Pth</i>	I.5
Incomplete	
<i>/// n nb mɜ'.t</i>	I.3
<i>im.y-r ///</i>	I.7
<i>/// m pr [Pth]</i>	I.8, 15 (2)

TABLE 4. (Suite et fin).

Bibliography

ABD EL-AAL 2009

S.S. Abd el-Aal, "Some Blocks Belonging to the Tias from Kafr el-Gebel", in U. Rößler-Köhler, T. Tawfik (ed.), *Die ihr vorbeigehen werden... Wenn Gräber, Tempel und Statuen sprechen. Gedenkschrift für Prof. Dr. Sayed Tawfik Ahmed*, SDAIK 16, p. 1-4.

ABOU-GHAZI 1987

D. Abou-Ghazi, "The Field of Egypt Antiquities Service in Memphis and Saqqarah", *ASAE* 66, p. 1-73.

ADLY, GRIMAL 2010

E. Adly, N. Grimal, *BIA* 41.

AFFARA 2010

M. Affara, "A New Kingdom Stela in the National Museum of Antiquities, Leiden", *JARCE* 46, p. 147-157.

AL-AYEDI 2006

A.R. Al-Ayedi, *Index of Egyptian Administrative, Religious and Military Titles of the New Kingdom*, Ismailia.

ALTENMÜLLER 2002

H. Altenmüller, "Der Himmelsaufstieg des Grabherrn – Zu den Szenen des *zš wꜣd* in den Gräbern des Alten Reiches", *SAK* 30, p. 1-42.

ANDREU-LANOË 2013

G. Andreu-Lanoë (ed.), *Le dessin dans l'Égypte ancienne : l'art du contour*, Paris.

ANDREWS 1978

C.A.R. Andrews, "A Family for Anhai?", *JEA* 64, p. 88-98.

ANONYMOUS 1973

Anonymous, *Antiquités égyptiennes, Strasbourg. Exposition a l'ancienne douane 12 juillet – 15 octobre 1973*, Strasbourg.

ANONYMOUS 1981

Anonymous, *Kunstschätze der Karl-Marx-Universität*, Leipzig.

ANTHES 1965

R. Anthes, *Mit Rahineh 1956, Museum Monographs*.

ASSEM 2012

R. Assem, "Hathor's Cult in Memphis", in L. Evans (ed.), *Ancient Memphis "Enduring is the Perfection"*. *Proceedings of the International Conference held at Macquarie University, Sydney on August 14-15, 2008*, OLA 214, p. 9-26.

ASSMANN 1973

J. Assmann, *Grabung im Asasif 1963-1970*, II, *Das Grab des Basa (Nr. 389) in der Thebanischen Nekropole*, ArchVer 6.

ASSMANN 1991

J. Assmann, *Das Grab des Amenemope TT 41, Theben 3*.

ASTON 2011

B.G. Aston, "The Pottery", in M.J. Raven *et al.*, *The Memphite Tomb of Horemheb Commander in Chief of Tutankhamun, V, The Forecourt and the Area South of the Tomb With Some Notes on the Tomb of Tia*, PALMA-Eg 6, p. 191-303.

AUBENAS 2011

S. Aubenas, "Un fonds de photographies unique sur l'Égypte", in M.L. Prévost, E. Delange, B. Mathieu *et al.* (ed.), *Visions d'Égypte: Émile Prisse d'Avennes (1807-1879)*, Paris, p. 119-139.

AUBERT, AUBERT 1974

J.-F. Aubert, L. Aubert, *Statuettes égyptiennes, chouabtis, ouchebtis*, Paris.

BADAWI 1944

A. Badawi, "Zwei Denkmäler der Grossen Gaugrafen von Memphis Amenophis Iwjj", *ASAE* 44, p. 181-206.

BARTA 1968

W. Barta, *Aufbau und Bedeutung der altägyptischen Opferformel*, ÄgForsch 24.

BARTA 1984

W. Barta, *LÄ* V, col. 772-776, s. v. "Sechem".

BEREND 1882

W.B. Berend, *Principaux monuments du Musée égyptien de Florence*, BEFE 51.

BERLANDINI-GRENIER 1976

J. Berlandini-Grenier, "Varia Memphitica I (I)", *BIFAO* 76, p. 301-316.

- BERLANDINI 1977
J. Berlandini, "Varia Memphitica II (II-III)", *BIFAO* 77, p. 29-44.
- BERLANDINI 1979
J. Berlandini, "Varia Memphitica III : le général Ramsès-nakht", *BIFAO* 79, p. 249-265.
- BERLANDINI 1981
J. Berlandini, "Varia Memphitica IV : un monument d'Imenemint/Iny à Hathor", *BIFAO* 81, p. 9-20.
- BERLANDINI 1982
J. Berlandini, "Varia Memphitica V : monuments de la chapelle funéraire du gouverneur Ptahmès", *BIFAO* 82, p. 85-103.
- BERLANDINI 1983
J. Berlandini, "La déesse bucéphale : une iconographie particulière de l'Hathor memphite", *BIFAO* 83, p. 33-50.
- BERLANDINI-KELLER 2011
J. Berlandini-Keller, "Un secteur de Saqqâra prospecté avant Lepsius. Les stèles Perrot de Iourekhy et de Mentouy, musée Calvet, Avignon", *EAO* 62, p. 31-46.
- BERMAN 1999
L.M. Berman, *Catalogue of Egyptian Art. The Cleveland Museum of Art*, New York.
- BIERBRIER 1982
M.L. Bierbrier, *Hieroglyphic Texts from Egyptian Stelae, etc., in the British Museum, Part 10*, *HTBM* 10.
- BINDER 2008
S. Binder, *The Gold of Honour in New Kingdom Egypt*, *ACE-Stud* 8.
- BLANCHEGORGE 2007
E. Blanchegorge, "Les collections égyptiennes du musée Antoine-Vivenel", in L. Camino, C. Papier-Lecostey (ed.), *Collections égyptiennes du musée Antoine-Vivenel de Compiègne*, Compiègne, p. 11-15.
- BOESER 1911
P.A.A. Boeser, *Beschrijving van de Egyptische verzameling in het Rijksmuseum van Oudheden te Leiden. De monumenten van het Nieuwe Rijk. Eerste afdeeling: Graven*, The Hague.
- BOESER 1912
P.A.A. Boeser, *Beschrijving van de Egyptische verzameling in het Rijksmuseum van Oudheden te Leiden. De monumenten van het Nieuwe Rijk. Tweede afdeeling: Pyramiden, Lijkenvazenkist, Offertafels, Beelden*, The Hague.
- BOESER 1913
P.A.A. Boeser, *Beschrijving van de Egyptische verzameling in het Rijksmuseum van Oudheden te Leiden. De monumenten van het Nieuwe Rijk. Derde afdeeling: Stèles*, The Hague.
- BOHLEKE 1991
B. Bohleke, *The Overseers of Double Granaries of Upper and Lower Egypt in the Egyptian New Kingdom, 1570-1085 B.C.*, Doctoral Thesis, Yale University, Ann Arbor.
- BOOM 1994
M. Boom, "Tekenen met licht. De fotograaf A. Jarrot en beeldend kunstenaar Willem de Famars Testas in Egypte, 1858-1860", *Bulletin van het Rijksmuseum* 42/3, p. 185-201.
- BORCHARDT 1925
L. Borchardt, *Statuen und Statuetten von Königen und Privatleuten im Museum von Kairo. Teil 2: Text und Tafeln zu Nr 381-653*, *Catalogue général des antiquités égyptiennes du musée du Caire, Nr. 1-1294*, Cairo.
- BORCHARDT 1931
L. Borchardt, "Ägyptische »Altertümer«, die ich für neuzeitlich halte", *ZÄS* 66, p. 1-4.
- BOSTICCO 1965
S. Bosticco, *Museo Archeologico di Firenze. Le Stele Egiziane del Nuovo Regno, Cataloghi dei Musei e Gallerie d'Italia*.
- BRAND 2000
P.J. Brand, *The Monuments of Seti I: Epigraphic, Historical and Art Historical Analysis*, *PdÄ* 16.
- BROVARSKI 1984
E. Brovarski, *LÄ* V, col. 1055-1064, s. v. "Sokar".
- CAMINO, PAPIER-LECOSTEY 2007
L. Camino, C. Papier-Lecostey (ed.), *Collections égyptiennes du musée Antoine-Vivenel de Compiègne*, Compiègne.

- CAPART 1940
J. Capart, "À propos d'un index égyptologique", *CdE* 15/29, p. 249-250.
- CHRISTIE'S 1976
Christie's Sale Catalogue, 6 July 1976, London.
- CHRISTIE'S 1992
Christie's Sale Catalogue: Fine Antiquities, London, Wednesday 9 December 1992 at 10.30 a.m., London.
- C.L. 1988
C.L., "Semelle du sarcophage de Ptahmès", in P. Le Nouène, D. Austin (ed.), *Les cultes funéraires en Égypte et en Nubie*, Calais, p. 42-43.
- DANIEL 2004
M. Daniel, "Gustave Le Gray (1820-1884)", in P. Le Nouène, D. Austin (ed.), *Heilbrunn Timeline of Art History, New York*, accessed 11.02.2014, http://www.metmuseum.org/toah/hd/gray/hd_gray.htm.
- DANIEL 2008
M. Daniel, "The Rise of Paper Photography in 1850s France", in *Heilbrunn Timeline of Art History, New York*, accessed 11.02.2014, http://www.metmuseum.org/toah/hd/frph/hd_frph.htm.
- DARESSY 1889
G. Daressy, "Remarques et notes", *RT* II, p. 79-95.
- DARIS 2005
S. Daris, "Note per la storia dell'esercito romano in Egitto III", *Studi di egittologia e di papirologia: rivista internazionale* 2, p. 57-74.
- DAVIES 1908
N. de G. Davies, *The Rock Tombs of El Amarna, IV, Smaller Tombs and Boundary Stelae*, ASEg 16.
- DAVIES 1925
N. de G. Davies, *The Tomb of the Two Sculptors at Thebes*, MMAEE 4.
- DAVIES 1926
N. de G. Davies, *The Tomb of Huy, Viceroy of Nubia in the Reign of Tut'ankhamun*, TTS 4.
- DAVIES 1927
N. de G. Davies, *Two Ramesside Tombs at Thebes*, MMAEE 5.
- DAVIES 1933
N. de G. Davies, *The Tomb of Nefer-Hotep at Thebes*, MMAEE 9.
- DAVIES 1941
N. de G. Davies, *The Tomb of the Vizier Ramose*, MET 1.
- DAVIES 1948
N. de G. Davies, *Seven Private Tombs at Kurnah*, MET 2.
- DAVIES, GARDINER 1915
Nina de Garis Davies, A.H. Gardiner, *The Tomb of Amenemhet (No. 82)*, TTS 1.
- DAVIS 1907
T.M. Davis, *The Tomb of Iouiya and Touiyou, Theodore M. Davis' Excavations* 2.
- DAVIS 1908
T.M. Davis, *The Funeral Papyrus of Iouiya, Theodore M. Davis' Excavations* 3.
- DAWSON, UPHILL, BIERBRIER 2012
W.R. Dawson, E.P. Uphill, M.L. Bierbrier, *Who Was Who in Egyptology*, 4th rev. ed., London.
- DE FAMARS TESTAS 1988
W. De Famars Testas, *Reisschetsen uit Egypte 1858-1860, naar ongepubliceerde handschriften bewerkt en geannoteerd door Maarten J. Raven*, Maarssen, The Hague.
- DE MORGAN 1897
J. De Morgan, *Carte de la nécropole memphite. Dahchour, Sakkarah, Abou-Sir*, Cairo.
- DE ROUGÉ 1877
J. De Rougé, *Inscriptions hiéroglyphiques copiées en Égypte pendant la mission scientifique de M. le Vicomte Emmanuel De Rougé, Études égyptologiques* 10.
- G. DEVÉRIA 1896
G. Devéria, "Théodule Devéria (1831-1871). Notice biographique", in G. Maspero (ed.), *Théodule Devéria mémoires et fragments* I, BIEG 4, p. I-XLVIII.
- TH. DEVÉRIA 1896
Th. Devéria, "Notes sur les listes hiéroglyphiques des conquêtes de Toutmès III à M. le Directeur de la *Revue archéologique*", in G. Maspero (ed.), *Théodule Devéria mémoires et fragments* I, BIEG 4, p. 203-207.

- DEWACHTER 1984
M. Dewachter, "Exploitation des manuscrits d'un égyptologue du XIX^e siècle Prisse d'Avennes", *BSFE* 101, p. 49-71.
- DEWACHTER 1985
M. Dewachter, "L'Égypte dans les musées, châteaux, bibliothèques et sociétés savantes de province", *BSFE* 103, p. 27-39.
- DJUŽEVA 2000
O. Djuževa, "Das Grab des Generals Amenemint in Saqqara", in M. Bartá, J. Krejčí (ed.), *Abusir and Saqqara in the Year 2000, ArOr-Suppl* 9, p. 77-98.
- DRENKHAHN 1989
R. Drenkhahn, *Ägyptische Reliefs im Kestner-Museum Hannover, Sammlungskatalog* 5.
- DURAND 2013
D. Durand, "Les photographies des sculptures grecques du Sérapéum de Memphis par Théodule Devéria", in R. Bertho, J.-P. Garric, F. Queyrel (ed.), *Patrimoine photographié, patrimoine photographique*, accessed 31.03.2013, <http://inha.revues.org/3982>.
- EDWARDS 1986
I.E.S. Edwards, "The Shetayet of Rosetau", in H. Lesko (ed.), *Egyptological Studies in Honor of Richard A. Parker. Presented on the Occasion of His 78th Birthday December 10, 1983*, Hannover, London, p. 27-36.
- ÉTIENNE 2006
M. Étienne, *Journey to the Afterlife: Egyptian Antiquities from the Louvre*, Paris.
- EVARD-DERRIKS 1981
C. Evard-Derriks, "Pied de sarcophage", in *Artisans de l'Égypte ancienne, Musée royal de Mariemont, 17 mars-21 juin 1981*, Mariemont, p. 28-29.
- FRANKE 1993
D. Franke, "Reliefblock aus dem Grab des Ptahmose in Saqqara", in E. Bayer-Niemeier et al., (ed.), *Liebieghaus-Museum alter Plastik Ägyptische Bildwerke. Band III. Skulptur, Malerei, Papyri und Särge*, Melsungen, p. 159-172.
- FRANKFORT, PENDLEBURY 1933
H. Frankfort and J.D.S. Pendlebury, *The City of Akhenaten II, ExcMem* 40.
- FRAZER 1997
K.J. Frazer, "The Architecture", in G.T. Martin, *The Tomb of Tia and Tia. A Royal Monument of the Ramesside Period in the Memphite Necropolis, ExcMem* 58, p. 3-15.
- FREED 1982
R. Freed, "Costume", in J. Bourriau (ed.), *Egypt's Golden Age: The Art of Living in the New Kingdom 1558-1085 B.C. Catalogue of the Exhibition*, Boston, p. 170-172.
- FROOD 2007
E. Frood, *Biographical Texts from Ramessid Egypt, Writings from the Ancient World* 26.
- GABALLA 1977
G.A. Gaballa, *The Memphite Tomb-Chapel of Mose*, Warminster.
- GABALLA, KITCHEN 1969
G.A. Gaballa, K.A. Kitchen, "The Festival of Sokar", *Or* 38, p. 1-76.
- GAMER-WALLERT 1983
I. Gamer-Wallert, "Das Grab des Hohenpriesters des Ptah, Mrj-Pth, in Saqqara", *WdO* 14, p. 99-129.
- GAUTHIER 1935
H. Gauthier, "Un pilier Π au Musée du Caire", *ASAE* 35, p. 81-96.
- GESSLER-LÖHR 1997
B. Gessler-Löhr, "Bemerkungen zur Nekropole des Neuen Reiches von Saqqara vor der Amarna-Zeit, II: Gräber der Bürgermeister von Memphis", *OMRO* 77, p. 31-61.
- GESSLER-LÖHR 2007a
B. Gessler-Löhr, "Pre-Amarna Tomb Chapels in the Teti Cemetery North at Saqqara", *BACE* 18, p. 65-108.
- GESSLER-LÖHR 2007b
B. Gessler-Löhr, "Reliefblock aus dem Grab des Hohenpriesters Meri-Ptah", in S. Albersmeier (ed.), *Ägyptische Kunst. Bestandskatalog Badisches Landesmuseum Karlsruhe*, Munich, p. 32-36, 54-55.

- GESSLER-LÖHR 2012
B. Gessler-Löhr, "Pre-Amarna or Post-Amarna? The Tomb of the God's Father Hatiay at Saqqara", in L. Evans (ed.), *Ancient Memphis "Enduring is the Perfection". Proceedings of the International Conference Held at Macquarie University, Sydney on August 14-15, 2008*, OLA 214, p. 147-191.
- GNIRS 1996
A.M. Gnirs, *Militär und Gesellschaft: ein Beitrag zur Sozialgeschichte des Neuen Reiches*, SAGA 17.
- GOHARY 1991a
S. Gohary, "A Monument of the Royal Scribe Tjuroy", BIFAO 91, p. 191-194.
- GOHARY 1991b
S. Gohary, "The Tomb-Chapel of the Royal Scribe Amenemone at Saqqara", BIFAO 91, p. 195-205.
- GOHARY 2009
S. Gohary, *The Twin Tomb Chapel of Nebnefer & His Son Mahu at Sakkara*, Cairo.
- GOHARY 2010
S.G. Gohary, "The Cult-Chapel of the Fortress Commander Huynefer at Saqqara", in A. Woods, A. McFarlane, S. Binder (ed.), *Egyptian Culture and Society. Studies in Honour of Naguib Kanawati*, I, Cairo, p. 159-163.
- GOMÀÀ 1973
F. Gomaà, *Chaemwese Sohn Ramses' II. und Hoherpriester von Memphis*, ÄA 27.
- GORDON, SCHWABE 2004
A.H. Gordon, C.W. Schwabe, *The Quick and the Dead. Biomedical Theory in Ancient Egypt*, *Egyptological Memoirs* 4.
- GRECO 2011a
C. Greco, "Qualche considerazione sulla statua cubica AST 23 di Ptahmes, in nTr n PtH, conservata a Leiden", in S. Pernigotti, P. Buzi (ed.), *Lo scriba ed il suo re, Atti del V colloquio di Egittologia ed Antichità copte, Bologna 5-6 luglio 2010*, Imola, p. 101-109.
- GRECO 2011b
C. Greco, "The Lost Tomb of Ptahmes", in P. Buzi, D. Picchi, M. Zecchi (ed.), *Aegyptiaca et Coptica. Studi in onore di Sergio Pernigotti*, BAR-IS 2264, p. 34-38.
- GUKSCH 1983
H. Guksch, "Wsr-ḥꜣt und ḥꜣtjꜣꜣ zur Zeit Sethos I.", GM 64, p. 23-24.
- GUKSCH 1994
H. Guksch, *Königsdienst: zur Selbstdarstellung der Beamten in der 18. Dynastie*, SAGA 11.
- HABACHI, ANUS 1977
L. Habachi, P. Anus, *Le Tombeau de Naji à Gournet Mar'ei (no. 271)*, MIFAO 97.
- HALBERTSMA 2003
R.B. Halbertsma, *Scholars, Travellers and Trade. The Pioneer Years of the National Museum of Antiquities in Leiden, 1818-40*, London.
- HANNIG 2006
R. Hannig, *Ägyptisches Wörterbuch II: Mittleres Reich und Zweite Zwischenzeit*, KAW 112.
- HARI 1964
R. Hari, *Horemheb et la reine Moutnedjemet ou la fin d'une dynastie*, Genève.
- HASSAN 1976
A. Hassan, *Stöcke und Stäbe im Pharaonischen Ägypten bis zum Ende des Neuen Reiches*, MÄS 33.
- HASSAN 1953
S. Hassan, *Excavations at Giza, VIII, The Great Sphinx and Its Secrets*, Cairo.
- HAYES 1938
W.C. Hayes, "A Writing-Palette of the Chief Steward Amenhotep and Some Notes on Its Owner", JEA 24, p. 9-24.
- HAYES 1959
W.C. Hayes, *The Scepter of Egypt. A Background for the Study of the Egyptian Antiquities in The Metropolitan Museum of Art. Part II: The Hyksos Period and the New Kingdom (1675-1080 B.C.)*, Cambridge, MA.
- HAYS 2008-2009
H.M. Hays, "Epigraphical Studies: Imenemwia and Ptahemwia", in M.J. Raven *et al.*, "Preliminary Report on the Leiden Excavations at Saqqara, Season 2008: The Tomb of Ptahemwia", JEOL 41, p. 13-17.

- HAYS 2011
H.M. Hays, "On the Architectural Development of Monumental Tombs South of the Unas Causeway at Saqqara from the Reigns of Akhenaten to Ramses II", in M. Bárta, F. Coppens, J. Krejčí (ed.), *Abusir and Saqqara in the Year 2010*, I, Prague, p. 84-105.
- HELCK 1958
W. Helck, *Zur Verwaltung des Mittleren und Neuen Reichs*, *PdÄ* 3-3a.
- HELCK 1960
W. Helck, *Materialien zur Wirtschaftsgeschichte des Neuen Reiches*, I, *Die Eigentümer, Abhandlungen der Geistes- und Sozialwissenschaftlichen Klasse*.
- HELCK 1975
W. Helck, *LÄ* I, col. 875-880, s. v. "Bürgermeister".
- HERB 2001
M. Herb, *Der Wettkampf in den Marschen. Quellenkritische, naturkundliche und sporthistorische Untersuchungen zu einem altägyptischen Szenentyp, Nikephoros-B* 5.
- HOFMANN 2004
E. Hofmann, *Bilder im Wandel. Die Kunst der Ramessidischen Privatgräber, Theben* 17.
- HÖLBL 1985
G. Hölbl, *Museo Archeologico Nazionale di Napoli. Le Stele Funerarie della Collezione Egizia, Catalogi die Musei e Gallerie d'Italia*.
- HÖLZL 2007
R. Hözl, *Götter Menschen Pharaonen, 3500 Jahre ägyptische Kultur. Meisterwerke der Ägyptisch-Orientalischen Sammlung des Kunsthistorischen Museums Wien*, Speyer.
- HÜTTNER, SATZINGER 1999
M. Hüttner, H. Satzinger, *Kunsthistorisches Museum Wien, Ägyptisch-orientalische Sammlung: Stelen, Inschriftsteine und Reliefs aus der Zeit der 18. Dynastie*, *CAA* 16.
- IBRAHIM ALY 1998
M. Ibrahim Aly, "Unpublished Blocks from Saqqara", *MDAIK* 54, p. 219-226.
- JACOBSEN 2007
K. Jacobsen, *Odaliques & Arabesques: Orientalist Photography 1839-1925*, London.
- JAMES 1970
T.G.H. James, *Hieroglyphic Texts from Egyptian Stelae etc., Part 9, HTBM* 9.
- JANSSEN 1957
J.M.A. Janssen, "Egyptische oudheden verzameld door W.A. Van Leer, opnieuw uitgegeven door Jozef M.A. Janssen", *MVEOL* 12, p. 17-19.
- JEFFREYS 2001
D.G. Jeffreys, "Memphis", in D.B. Redford (ed.), *The Oxford Encyclopedia of Ancient Egypt*, vol. 2, Oxford, p. 373-376.
- JUNGE 2001
F. Junge, *Late Egyptian Grammar. An Introduction*, Translated by David Warburton, Oxford.
- KAMAL 1916
A. Kamal Bey, "Fouilles à Deir Dronka et à Assiout (1913-1914)", *ASAE* 16, p. 65-114.
- KAMPP 1996
F. Kampp, *Die Thebanische Nekropole. Zum Wandel des Grabgedankens von der XVIII. bis zur XX. Dynastie, Theben* 13.
- KARIG 1967
J. Karig, "Kultkammer des Amenhotep", in H. Satzinger (ed.), *Ägyptisches Museum Berlin*, Berlin, p. 75-76.
- KARIG 1969
J.S. Karig, "Die Kultkammer des Amenhotep aus Deir Durunka", *ZÄS* 95, p. 27-34.
- KEES 1958
H.A.J. Kees, *Das Priestertum im ägyptischen Staat vom neuem Reich bis zum Spätzeit*, *PdÄ* 1.
- KEIMER 1929
L. Keimer, "Sur un bas-relief en calcaire représentant la déesse dans le sycomore et la déesse dans la dattier", *ASAE* 29, p. 81-88.
- KEMP 2012
B. Kemp, *The City of Akhenaten and Nefertiti. Amarna and its People*, London.
- KITCHEN 1977
K.A. Kitchen, *LÄ* II, col. 119-120, s. v. "Henu-Barke".
- KITCHEN 1991
K.A. Kitchen, "Towards a Reconstruction of Ramesside Memphis", in E. Bleiberg, R. Freed

- (ed.), *Fragments of a Shattered Visage: The Proceedings of the International Symposium of Ramesses the Great*, MIEAA 1, p. 87-104.
- KOEFOD-PETERSEN 1948
O. Koefod-Petersen, *Les stèles égyptiennes*, PGNy Carlsberg 1.
- KOEFOD-PETERSEN 1956
O. Koefod-Petersen, *Catalogue des bas-reliefs et peintures égyptiens*, Copenhagen.
- KRAUSPE 1987
R. Krauspe, *Ägyptisches Museum der Karl-Marx-Universität Leipzig. Führer durch die Ausstellung*, 3rd ed., Leipzig.
- KRI
K.A. Kitchen 1975-1989, *Ramesside Inscriptions*, vol. I-VIII, Oxford.
- KUHLMANN, SCHENKEL 1983
K.P. Kuhlmann, W. Schenkel, *Das Grab des Ibi, Obergutsverwalter des Gottesgemahlin des Amun (Thebanisches Grab Nr. 36)*, ArchVer 15.
- LACAU 1909-1916
P. Lacau, *Stèles du Nouvel Empire. Catalogue général des antiquités égyptiennes du musée du Caire*, nos. 34001-34064, 34065-34189, Cairo.
- LAUER 1961
J.-P. Lauer, "Mariette à Saqqarah: Du Sérapéum à la direction des antiquités", in J. Sainte Fare Garnot (ed.), *Mélanges Mariette, BiEtud* 32, p. 5-55
- LECLANT 1975
J. Leclant, *LÄ* I, col. 1156-1160m s. v. "Earu-Gefilde".
- LECLANT, CLERC 1998
J. Leclant, G. Clerc, "Fouilles et travaux en Égypte et au Soudan, 1996-1997", *Or* 67, p. 315-444.
- LEITZ 2002
C. Leitz, *Lexikon der ägyptischen Götter und Götterbezeichnungen IV*, OLA 113.
- LD
C.R. Lepsius 1897-1913, *Denkmaeler aus Aegypten und Aethiopien*, Leipzig.
- LEPSIUS 1853
K.R. Lepsius, *Letters from Egypt, Ethiopia, and the Peninsula of Sinai*, London.
- LIEBLEIN 1868
J.A.C. Lieblein, *Katalog öfver Egyptiska fornlemningar i National-Museum*, Stockholm.
- LOHWASSER 2008
A. Lohwasser, "Der „Vorsteher der Arbeiten“ Hatiaï", in C. Tietze (ed.), *Amarna. Lebensräume – Lebensbilder – Weltbilder*, Potsdam, p. 163-165.
- LOPRIENO 1995
A. Loprieno, *Ancient Egyptian. A Linguistic Introduction*, Cambridge.
- LUNSSINGH SCHEURLEER 2009
R.A. Lunsingh Scheurleer, *Toekomst voor het Verleden: 75 jaar Allard Pierson Museum, Archeologisch Museum van de Universiteit van Amsterdam 1934-2009*, Zwolle.
- MÁLEK 1981
J. Málek, "Review Article: Two Problems Connected with New Kingdom Tombs in the Memphite Area", *JEA* 67, p. 156-165.
- MÁLEK 1987
J. Málek, "The Saqqara Statue of Ptahmose, Mayor of the Memphite Suburbs", *RdE* 38, p. 117-137.
- MÁLEK 1988
J. Málek, "The Royal Butler Hori at Northern Saqqâra", *JEA* 74, p. 125-136.
- MÁLEK 1992
J. Málek, "A Meeting of the Old and New. Saqqâra during the New Kingdom", in A.B. Lloyd (ed.), *Studies in Pharaonic Religion and Society in Honour of J. Gwyn Griffiths*, London, p. 57-76.
- MALININE, POSENER, VERCOUTTER 1968
M. Malinine, G. Posener, J. Vercoutter, *Catalogue des stèles du Sérapeum de Memphis*, Paris.
- MARIETTE 1857
A. Mariette, *Le Sérapeum de Memphis*, Paris.
- MARIETTE 1868
A. Mariette, *Notice des exposés dans les Galeries provisoires du musée d'Antiquités égyptiennes de S.A. le Vice-Roi à Boulaq*, 2nd ed. 1864, Alexandria.
- MARIETTE 1872
A. Mariette, *Monuments divers recueillis en Égypte et en Nubie (Texte par G. Maspero, 1889)*, Paris.

- MARIETTE 1882
A. Mariette, *Le Sérapeum de Memphis*, I, *Publié d'après le manuscrit de l'auteur par G. Maspero*, Paris.
- MARIETTE 1889
A. Mariette, *Les Mastabas de l'Ancien Empire*, Paris.
- G.T. MARTIN 1971
G.T. Martin, *Egyptian Administrative and Private-Name Seals Principally of the Middle Kingdom and Second Intermediate Period*, Oxford.
- G.T. MARTIN 1976
G.T. Martin, "Excavations at the Memphite Tomb of Horemheb, 1975: Preliminary Report", *JEA* 62, p. 5-13.
- G.T. MARTIN 1979
G.T. Martin, *The Tomb of Hetepka and Other Reliefs and Inscriptions from the Sacred Animal Necropolis in North Saqqâra*, London.
- G.T. MARTIN 1985
G.T. Martin, *The Tomb-Chapels of Paser and Ra'ia at Saqqâra*, *ExcMem* 52.
- G.T. MARTIN 1987
G.T. Martin, *Corpus of Reliefs of the New Kingdom from the Memphite Necropolis and Lower Egypt*, London.
- G.T. MARTIN 1989
G.T. Martin, *The Memphite Tomb of Horemheb, Commander-in-Chief of Tut'ankhamûn*, I, *the Reliefs, Inscriptions, and Commentary*, London.
- G.T. MARTIN 1991
G.T. Martin, *The Hidden Tombs of Memphis, New Discoveries from the Time of Tutankhamun and Ramesses the Great*, London.
- G.T. MARTIN 1995
G.T. Martin, "Reliefs and Architectural Fragments from New Kingdom Tombs in the Cairo Museum, Principally from the Memphite Necropolis", *NKMN* 4, p. 5-33.
- G.T. MARTIN 1997
G.T. Martin, *The Tomb of Tia and Tia, a Royal Monument of the Ramesside Period in the Memphite Necropolis*, *ExcMem* 58.
- G.T. MARTIN 2001
G.T. Martin, *The Tombs of Three Memphite Officials: Ramose, Khay and Pabes*, *ExcMem* 66.
- G.T. MARTIN 2012
G.T. Martin, *The Tomb of Maya and Meryt*, I, *The Reliefs, Inscriptions, and Commentary*, *ExcMem* 99.
- K. MARTIN 1986
K. Martin, *L'ÁVI*, col. II52-II54, s. v. "Was-Zepter".
- MASPERO 1914
G. Maspero, *Guide du visiteur au musée du Caire*, 3rd ed., Cairo.
- MASQUELIER-LOORIUS 2013
J. Masquelier-Loorius, *Séthi I^{er} et le début de la XIX^e dynastie*, *Les grands pharaons*.
- MAYSTRE 1992
C. Maystre, *Les grand prêtres de Ptah de Memphis*, *OBO* 113.
- MMA ANNUAL REPORT 2005
The Metropolitan Museum of Art Annual Report for the Year 2004-2005, New York.
- MOGENSEN 1919
M. Mogensen, *Stèles égyptiennes au Musée national de Stockholm*, Copenhagen.
- MÜLLER 1991
I. Müller, "Stele des Kamose", in K.-H. Priese (ed.), *Ägyptisches Museum*, Mainz am Rhein, p. 142-143.
- MUNRO 1993
P. Munro, *Der Unas-Friedhof Nord-West I, Topographisch-historische Einleitung. Das Doppelgrab der Königinnen Nebet und Khenut*, *GöttMisz* 59.
- NAVRÁTILOVÁ 2007
H. Navrátilová, *The Visitors' Graffiti of Dynasties XVIII and XIX in Abusir and Saqqara, The Visitor's Graffiti* 1.
- NIZZOLI 1841
A. Nizzoli, *Memorie sull' Egitto e specialmente sui costume delle donne orientale e gli harem, scritte durante il suo soggiorno in quel paese (1819-1828)*, Milan.
- OCKINGA 2000
B.G. Ockinga, "The Saqqara Tomb of the Overseer of Craftsmen and Chief Goldworker,

- Amenemone”, in M. Bartá, J. Krejčí (ed.), *Abusir and Saqqara in the Year 2000, ArOr-Suppl* 9, p. 121-132.
- OCKINGA 2004
B.G. Ockinga, *Amenemone the Chief Goldsmith: a New Kingdom Tomb in the Teti Cemetery at Saqqara, ACE Reports* 22.
- OCKINGA 2012
B.G. Ockinga, “Evidence for New Kingdom Tomb Structures in the Teti Pyramid Cemetery North: Insights from the Macquarie Excavations”, in L. Evans (ed.), *Ancient Memphis “Enduring is the Perfection”. Proceedings of the International Conference held at Macquarie University, Sydney on August 14-15, 2008, OLA* 214, p. 371-395.
- PASQUALI 2011
St. Pasquali, *Topographie culturelle de Memphis I, a- Corpus: Temples et principaux quartiers de la XVIII^e dynastie, CENiM* 4.
- PASQUALI 2012
St. Pasquali, “Trois fonctionnaires memphites du Nouvel Empire”, *ENiM* 5, p. 33-149.
- PASQUALI 2013
St. Pasquali, “La tombe perdue de Bouri, employé du domaine d’Aton à Memphis”, *BIFAO* 113, p. 305-323.
- PASQUALI, GESSLER-LÖHR 2011
St. Pasquali, B. Gessler-Löhr, “Un nouveau relief du grand intendant de Memphis, Ipy, et le temple de Ptah du terrain-*b’b*”, *BIFAO* 113, p. 281-299.
- PECK 2011
W.H. Peck, *Egypt in Toledo. The Ancient Egyptian Collection at the Toledo Museum of Art*, Toledo.
- PENDLEBURY 1931
J.D.S. Pendlebury, “Preliminary Report of Excavations at Tell el-‘Amarna 1930-1”, *JEA* 17, p. 233-244.
- PERNIGOTTI 1991
S. Pernigotti, “Amalia Nizzoli e le sue “Memorie sull’Egitto”, in S. Pernigotti (ed.), *Aegyptiaca Bononiensia* I, Pisa, p. 3-84.
- PERNIGOTTI 2013
S. Pernigotti, “Le memorie di Amalia Nizzoli verso una nuova edizione”, in M. Betrò, G. Miniaci (ed.), *Talking along the Nile. Ippolito Rosellini, Travellers and Scholars of the 19th Century in Egypt. Proceedings of the International Conference held on the Occasion of the Presentation of Progetto Rosellini. Pisa, June 14-16, 2012*, Pisa, p. 177-185.
- PETERSON 1974
B. Peterson, “Ramesside Mannerism”, *MedMus-Bull* 9, p. 5-12.
- PETRIE 1902
W.M. Flinders Petrie, *Abydos Part I*, London.
- PICCHI 2011
D. Picchi, “Il pittore Pelagio Palagi e l’Egittologia ‘in miniatura’: amuletti, scarabei e placchette della terza collezione Nizzoli”, in P. Buzi, D. Picchi, M. Zecchi (ed.), *Aegyptiaca et Coptica. Studi in onore di Sergio Pernigotti, BAR-IS* 2264, p. 277-301.
- PINO 2005
C. Pino, “The Market Scene in the Tomb of Khaemhat (TT 57)”, *JEA* 91, p. 95-105.
- POLZ 2007
D. Polz, “Dra‘ Abu el-Naga: Die Residenznekropole Thebens in der 17. und frühen 18. Dynastie”, in G. Dreyer, D. Polz (ed.), *Begegnung mit der Vergangenheit – 100 Jahre in Ägypten. Deutsches Archäologisches Institut Kairo 1907-2007*, Mainz am Rhein, p. 234-243.
- POPOFF 2009
G.E. Popoff, “Nizzoli, Amalia, (1806-1845?)”, *The University of Chicago Library, Italian Women Writers*, accessed 06.04.2014, <http://www.lib.uchicago.edu/efts/IWW/BIOS/Ao219.html>.
- QUIBELL 1908
J.E. Quibell, *Excavations at Saqqara (1906-1907), FouillesSaqq.*
- QUIBELL 1909
J.E. Quibell, *Excavations at Saqqara (1907-1908), FouillesSaqq.*
- QUIBELL 1912
J.E. Quibell, *The Monastery of Apa Jeremias, FouillesSaqq 1908-9, FouillesSaqq 1909-10.*
- QUIBELL, HAYTER 1927
J.E. Quibell, A.G.K. Hayter, *Excavations at Saqqara: Teti Pyramid, North Side, FouillesSaqq.*

- RAEDLER 2004
C. Raedler, "Die Wesire Ramses' II. – Netzwerke der Macht", in R. Gundlach, A. Klug (ed.), *Das ägyptische Königtum im Spannungsfeld zwischen Innen- und Außenpolitik im 2. Jahrtausend v. Chr.*, KSG 1, p. 277-416.
- RAEDLER 2006
C. Raedler, "Zur Struktur der Hofgesellschaft Ramses' II.", in R. Gundlach, A. Klug (ed.), *Der ägyptische Hof des Neuen Reiches. Seine Gesellschaft und Kultur im Spannungsfeld zwischen Innen- und Aussenpolitik*, KSG 2, p. 39-87.
- RAEDLER 2009
C. Raedler, "Rank and Favour at the Early Ramesside Court", in R. Gundlach, J.H. Taylor (ed.), *4. Symposium zur ägyptischen Königsideologie / 4th Symposium on Egyptian Royal Ideology: Egyptian Royal Residences, London, June 1st-5th 2004*, KSG 4,1, p. 131-151.
- RAEDLER 2011
C. Raedler, "Prestige, Role and Performance. Ramesside High Priests of Memphis", in R. Gundlach, K. Spence (ed.), *5. Symposium zur altägyptischen Königsideologie / 5th Symposium on Egyptian Royal Ideology: Palace and Temple. Architecture – Decoration – Ritual. Cambridge, July 16th-17th, 2007*, KSG 4,2, p. 135-154.
- RAEDLER 2012
C. Raedler, "„Kopf der Schenut“ – politische Entscheidungsträger der Ära Ramses' II.", in H. Beinlich (ed.), *6. Symposium zur ägyptischen Königsideologie / 6th Symposium on Egyptian Royal Ideology „Die Männer hinter dem König“*, KSG 4,3, p. 123-150.
- RAMMANT-PEETERS 1983
A. Rammant-Peeters, *Les pyramidions égyptiens du Nouvel Empire*, OLA 11.
- RAMMANT-PEETERS 1994
A. Rammant-Peeters, *Palmen en Tempels. La photographie en Égypte au XIX^e siècle / 19th Century Photography in Egypt*, Leuven.
- RAVEN 2000
M.J. Raven, "Twenty-Five Years of Work in the New Kingdom Necropolis of Saqqara: Looking for Structure", in M. Bárta, J. Krejčí (ed.), *Abusir and Saqqara in the Year 2000*, *ArOr-Suppl* 9, p. 133-144.
- RAVEN 2005
M.J. Raven, *The Tomb of Pay and Raia at Saqqara*, *ExcMem* 74.
- RAVEN *et al.* 2001-2002
M.J. Raven *et al.*, "Preliminary Report on the Leiden Excavations at Saqqara, Season 2001: The Tomb of Meryneith", *JEOL* 37, p. 71-89.
- RAVEN *et al.* 2007
M.J. Raven *et al.*, "Preliminary Report on the Leiden Excavations at Saqqara, Season 2007: the Tomb of Ptahemwia", *JEOL* 40, p. 19-39.
- RAVEN *et al.* 2010
M.J. Raven *et al.*, "Preliminary Report on the Leiden Excavations at Saqqara, Season 2009: The Tomb of Khay II and Tatia", *JEOL* 42, p. 5-24.
- RAVEN, STARING 2007
M.J. Raven, N. Staring, "Stele des Hori", in C. Ewigleben (ed.), *Ägyptische Mumien. Unsterblichkeit im Land der Pharaonen*, Stuttgart, Mainz am Rhein, p. 180.
- RAVEN, VAN WALSEM 2011
M.J. Raven, R. Van Walsem, "The Site and its History", in M.J. Raven *et al.*, *The Memphite Tomb of Horemheb Commander in Chief of Tutankhamun, V: The Forecourt and the Area South of the Tomb With Some Notes on the Tomb of Tia*, *PALMA-Eg* 6.
- RAVEN, VAN WALSEM 2014
M.J. Raven, R. Van Walsem, *The Tomb of Meryneith at Saqqara*, *PALMA-Eg* 10.
- RHONÉ 1877
A. Rhoné, *L'Égypte à petites journées*, Paris.
- RHONÉ 1885
A. Rhoné, *Voyage en Égypte 1885. Album photographique de Qasd el-Kheir*, CDHR. Dpt Egypte, Arch. IFAO.
- ROBINS 2008
G. Robins, "Male Bodies and the Construction of Masculinity in New Kingdom Egyptian Art", in S.H. D'Auria (ed.), *Servant of Mut. Studies in Honor of Richard A. Fazzini*, *PdÄ* 28, p. 208-215.

- ROEDER 1924
G. Roeder, *Aegyptische Inschriften aus den Staatlichen Museen zu Berlin*, Leipzig.
- RUFFLE, KITCHEN 1979
J. Ruffle, K.A. Kitchen, "The Family of Urhiya and Yupa, High Stewards of the Ramesseum", in J. Ruffle, K.A. Kitchen, G.A. Gaballa (ed.), *Glimpses of Ancient Egypt. Studies in Honour of H.W. Fairman*, Warminster, p. 55-74.
- RUSSMANN 1980
E.R. Russmann, "The Anatomy of an Artistic Convention: Representation of the Near Foot in Two Dimensions through the New Kingdom", *BES* 2, p. 57-81.
- RUSSMANN 1989
E.R. Russmann, *Egyptian Sculpture: Cairo and Luxor*, London.
- SAITO 2006
M. Saito, "The Portico", in S. Yoshimura, *Abusir South I*, Tokyo, p. 180-186.
- SALEH, SOUROUZIAN 1986
M. Saleh, H. Sourouzian, *Die Hauptwerke im Ägyptischen Museum, Kairo*, Mainz am Rhein.
- SALVOLDI 2008
D. Salvoldi, "Thebes, Amarna, Memphis: Akhenaten's Officials with Double Tomb", in P. Kousoulis (ed.), *Tenth International Congress of Egyptologists, University of the Aegean, Department of Mediterranean Studies, Rhodes 22-29 May 2008. Abstracts of Papers*, Rhodes, p. 214-215.
- SCHIAPARELLI 1887
E. Schiaparelli, *Museo Archeologico di Firenze: Antichità Egizie*, Rome.
- SCHNEIDER 1977
H.D. Schneider, *Shabtis: An Introduction to the History of Ancient Egyptian Funerary Statuettes with a catalogue of the Collection of Shabtis in the National Museum of Antiquities at Leiden, Collections of the National Museum at Leiden* 2.
- SCHNEIDER 1996
H.D. Schneider, *The Memphite Tomb of Horemheb, Commander-in-Chief of Tut'ankhamün, II: a Catalogue of the Finds, ExcMem* 60.
- SCHNEIDER 2012
H.D. Schneider, *The Tomb of Iniuita in the New Kingdom Necropolis of Memphis at Saqqara, PALMA-Eg* 8.
- SCHNEIDER, RAVEN 1981
H. Schneider, M.J. Raven, *De Egyptische Oudheid: een inleiding aan de hand van de Egyptische verzameling in het Rijksmuseum van Oudheden te Leiden*, The Hague.
- SCHOTT 1957
S. Schott, *Wall Scenes from the Mortuary Chapel of the Mayor Paser, SAOC* 30.
- SCHULZ 1992
R. Schulz, *Die Entwicklung und Bedeutung des kuboiden Statuentypus. Eine Untersuchung zu den sogenannten „Würfelhockern“*, *HÄB* 33.
- SEYFRIED 1990
K.J. Seyfried, "Dritter Vorbericht über die Arbeiten des Ägyptologischen Instituts der Universität Heidelberg in thebanischen Gräbern der Ramessidenzeit", *MDAIK* 46, p. 341-353.
- SNAPE 2011
S. Snape, "Khaemwese and the Present Past: History and the Individual in Ramesside Egypt", in M. Collier, S. Snape (ed.), *Ramesside Studies in Honour of K.A. Kitchen*, Bolton, p. 465-473.
- SPACKMAN 2005
B. Spackman, "Orienting Italy in Amalia Nizzoli's *Memorie sull'Egitto*", *The Italianist* 25, p. 35-54.
- SPIEGELBERG 1896
W. Spiegelberg, *Rechnungen aus der Zeit Setis I. (circa 1350 v. Chr.) mit anderen Rechnungen des Neuen Reiches*, Strasbourg.
- STAEHELIN 1982
E. Staehelin, *LÄ* IV, col. 52-53, s. v. "Menit".
- STARING 2011
N. Staring, "Interpreting Figural Graffiti: Case Studies from a Funerary Context", in M. Horn et al. (ed.), *Current Research in Egyptology 2012. Proceedings of the Eleventh Annual Symposium which Took Place at Leiden University, the Netherlands January 2010*, Oxford, p. 145-156.

- STARING 2014
N. Staring, "A Relief from the Tomb of the Memphite Mayor Ptahmose in the Collection of the Nasher Museum of Art at Duke University", *BACE* 25, in press.
- STARING 2015
N. Staring, "The Title *ḥ3.ty-ḥ3 inb.w nw Pth* 'Mayor of beyond the walls of Ptah', and Early 19th Dynasty Temple Building at Mamphis".
- STEINDORFF 1942
G. Steindorff, "Two Egyptian Statues of the Ramessid Period", *JWAG* 5, p. 9-17.
- STEINDORFF 1946
G. Steindorff, *Catalogue of the Egyptian Sculpture in the Walters Art Gallery*, Baltimore.
- STEINDORFF 1947
G. Steindorff, "Fakes and Fates of Egyptian Antiquities. A Supplement to the Catalogue of Egyptian Sculpture", *JWAG* 10, p. 53-59.
- SULLIVAN 2002
E. Sullivan, "Jubilation Relief", in E. Hornung and B.M. Bryan (ed.), *The Quest for Immortality. Treasures of Ancient Egypt*, Washington, p. 162.
- TAKAMIYA, KASHIWAGI, YOSHIMURA 2011
I.H. Takamiya, H. Kashiwagi, S. Yoshimura, "Khaemwaset and His Monument at North Saqqara: A Record of Multiple Aspects of "the First Archaeologist", in V.G. Callender *et al.* (ed.), *Times, Signs and Pyramids. Studies in Honour of Miroslav Verner on the Occasion of His Seventieth Birthday*, Prague, p. 401-421.
- TAWFIK 1991
S. Tawfik, "Recently Excavated Ramesside Tombs at Saqqara I. Architecture", *MDAIK* 47, p. 403-409.
- TAYLOR 2001
J.A. Taylor, *An Index of Male Non-Royal Titles, Epithets, & Phrases of the 18th Dynasty*, London.
- TE VELDE 1967
H. Te Velde, *Seth, God of Confusion. A Study of his Role in Egyptian Mythology and Religion*, PdÄ 6.
- THIJS forthcoming
A. Thijs, "The Ramesside Section of the Serapeum".
- TIRADRITTI 1994
F. Tiradritti, *L'egittologo Luigi Vassalli-bey 1812-1887. Guida alla Mostra. Museo Egizio del Cairo, 9 maggio - 9 luglio 1994*, *StudEgypt*.
- VAN DEN BOORN 1988
G.P.F. Van den Boorn, *The Duties of the Vizier. Civil Administration in the Early New Kingdom*, London, New York.
- VANDIER 1954
J. Vandier d'Abbadie, *Deux tombes ramessides à Gournet-Mourraï*, *MIFAO* 87.
- VANDIER 1973
J. Vandier, *Musée du Louvre. Le département des antiquités égyptiennes. Guide sommaire*, Paris.
- VAN DIJK 1986
J. Van Dijk, "The Symbolism of the Memphite Djed-Pillar", *OMRO* 66, p. 7-20.
- VAN DIJK 1989
J. Van Dijk, "Two Blocks from the Tomb of Ptahmose, Mayor of Memphis and High Steward in the Domain of Ptah", *GM* 113, p. 47-54.
- VAN DIJK 1993
J. Van Dijk, *The New Kingdom Necropolis of Memphis: Historical and Iconographical Studies*, Doctoral Thesis, Rijksuniversiteit Groningen, Groningen.
- VAN DIJK 1995
J. Van Dijk, "Maya's Chief Sculptor Userhat-Hatiay. With a Note on the Length of the Reign of Horemheb", *GM* 148, p. 29-34.
- VAN DIJK 2008
J. Van Dijk, "New Evidence on the Length of the Reign of Horemheb", *JARCE* 44, p. 193-200.
- VAN HAARLEM, SCHEURLEER 1986
W.M. Van Haarlem, R.A. Lunsingh Scheurleer, *Gids voor de afdeling Egypte, Allard Pierson Museum Amsterdam*, Amsterdam.
- VAN LEER 1938
W.A. Van Leer, "Egyptische Oudheden Verzameld en Beschreven door W.A. Van Leer Supplement A", *MVEOL* 3, p. 29-32.
- VAN WALSEM 2001
R. Van Walsem, "Sporen van een Revolutie in Saqqara. Het nieuw ontdekte graf van Meryneith

- alias Meryre en zijn plaats in de Amarnaperiode”, *Phoenix* 47,1-2, p. 69-89.
- VAN WALSEM, RAVEN 2011
R. Van Walsem, M.J. Raven, “New Evidence on Horemheb’s Statuary”, in M.J. Raven *et al.*, *The Memphite Tomb of Horemheb Commander in Chief of Tutankhamun*, V, *The Forecourt and the Area South of the Tomb With Some Notes on the Tomb of Tia*, PALMA-Eg 6, p. 375-383.
- VERNUS 1969
P. Vernus, “Un fragment de bas-relief trouvé à Tanis”, *Kêmi* 19, p. 93-101.
- VOGELSANG-EASTWOOD 1993
G. Vogelsang-Eastwood, *Pharaonic Egyptian Clothing, Studies in Textile and Costume History* 2.
- VON BECKERATH 1995
J. Von Beckerath, “Das Problem der Regierungsdauer Haremhab”, *SAK* 22, p. 37-41.
- VON RECKLINGHAUSEN 2011
D. Von Recklinghausen, “Opferbringer und Forscher. Priester in den ägyptischen Tempeln”, in D. Von Recklinghausen and M.A. Stadler (ed.), *Kultorte. Mythen, Wissenschaft und Alltag in den Tempeln Ägyptens*, Berlin, p. 91-115.
- WADA 1999
K. Wada, 1999. “ネヘトの座像” (“On the Seated Statue of Nehet in the Matsuoaka Museum of Art, Tokyo”), *JES* 7, p. 104-109.
- WALDSTEIN 1926
C. Waldstein, *Alcmenes and the Establishment of the Classical Type in Greek Art*, Cambridge.
- WALLIS BUDGE 1909
E.A. Wallis Budge, *British Museum, A Guide to the Egyptian Galleries (Sculpture)*, London.
- WEGNER 2001
J. Wegner, “Institutions and Officials at South Abydos: An Overview of the Sigillographic Evidence”, *Le Sceau et l’administration dans la Vallée du Nil. Villeneuve d’Ascq 7-8 juillet 2000*, *CRIPÉL* 22, p. 77-106.
- WENIG 974
S. Wenig, “Das Grab des Soldatenschreibers iwj. Untersuchungen zu den memphitischen Grabreliefs des Neuen Reiches II”, in *Festschrift zum 150jährigen Bestehen des Berliner Ägyptischen Museums*, *MÄSB* 8, p. 239-245.
- WESTENDORF 1966
W. Westendorf, “Ursprung und Wesen der Maât, der altägyptischen Göttin des Rechts, der Gerechtigkeit und der Weltordnung”, in S. Lauffer (ed.), *Festgabe für Dr Walter Will: Ehrensenator der Universität München zum 70. Geburtstag am 12. November 1966*, Cologne.
- WILDUNG, REITER, ZORN 2010
D. Wildung, F. Reiter, O. Zorn, *Ägyptisches Museum und Papyrussammlung, Berlin. 100 Meisterwerke*, Berlin.
- WILKINSON, HILL 1983
C.K. Wilkinson, M. Hill, *Egyptian Wall Paintings. The Metropolitan Museum of Art’s Collection of Facsimiles*, New York.
- WILLEMS 1998
H. Willems, “The One and the Many in Stela Leiden VI”, *CdE* 73, p. 31-43.
- WOODS 2008
A. Woods, *A “Day in the Marshes”: A Study of Old Kingdom Marsh Scenes in the Tombs of the Memphite Cemeteries*, Unpublished Doctoral Thesis, Macquarie University, Sydney.
- WRESZINSKI 1923
W. Wreszinski, *Atlas zur Altaegyptischen Kulturgeschichte* I, Leipzig.
- ZIVIE 1984
A.-P. Zivie, *LÄ* V, col. 100-108, s. v. “Ramses I.”.
- ZIVIE 1988
A.-P. Zivie, “Aper-el et ses voisins : considerations sur les tombes rupestres de la XVIII^e dynastie à Saqqarah”, in A.-P. Zivie (ed.), *Memphis et ses nécropoles au Nouvel Empire. Nouvelles données, nouvelles questions*, Paris, p. 103-112.
- ZIVIE 2000
A.-P. Zivie, “La resurrection des hypogées du Nouvel Empire à Saqqara”, in M. Bartá, J. Krejčí (ed.), *Abusir and Saqqara in the Year 2000*, *ArOr-Suppl* 9, p. 173-192.

ZIVIE 2003

A.-P. Zivie, *Les tombeaux retrouvés de Saqqara*, Monaco.

ZIVIE 2009

A.-P. Zivie, *La Tombe de Maïa, Mère Nourricière du Roi Toutânkhamon et Grande du Harem (Bub. I.20), Les tombes du Bubasteion à Saqqara I.*

CHR. ZIVIE 1976

Chr. Zivie, *Giza au deuxième millénaire, BiEtud* 70.

ZIVIE-COCHE 1984

Chr. Zivie-Coche, *L'Ä V*, col. 303-309, s. v. "Ro-setau".



FIG. 1. Théodule Devéria 1859, *Sakkarah (Memphis). Tombeau de Ptah-mès*. Albumen silver print from a paper negative, 21.2 x 28.1 cm. The Metropolitan Museum of Art, Gilman Collection, Purchase, Joseph M. Cohen Gift, 2005 (2005.100.321).



Drawing: Nico Staring



FIG. 3a. Photograph of Panel Cairo JE 4874 taken by Théodule Devéria, 1859. Musée d'Orsay, Paris, Inv. PHO 1986 144 124, MS 178 128: *Memphis, Sakkarah, Relief de la chapelle de Ptah-Mès*. Printed on albumen paper from a salted paper negative, 22.8 × 8 cm.

© Musée d'Orsay, Distr. RMN-Grand Palais / Patrice Schmidt



FIG. 3b. Panel Cairo JE 4874.

After BERLANDINI 1982, pl. X.

BIFAO 114 (2014), p. 455-518. Nicó Staring

The Tomb of Ptahmose, Mayor of Memphis Analysis of an Early 19 th Dynasty Funerary Monument at Saqqara

© IFAO 2020

BIFAO en ligne

<https://www.ifao.egnet.net>

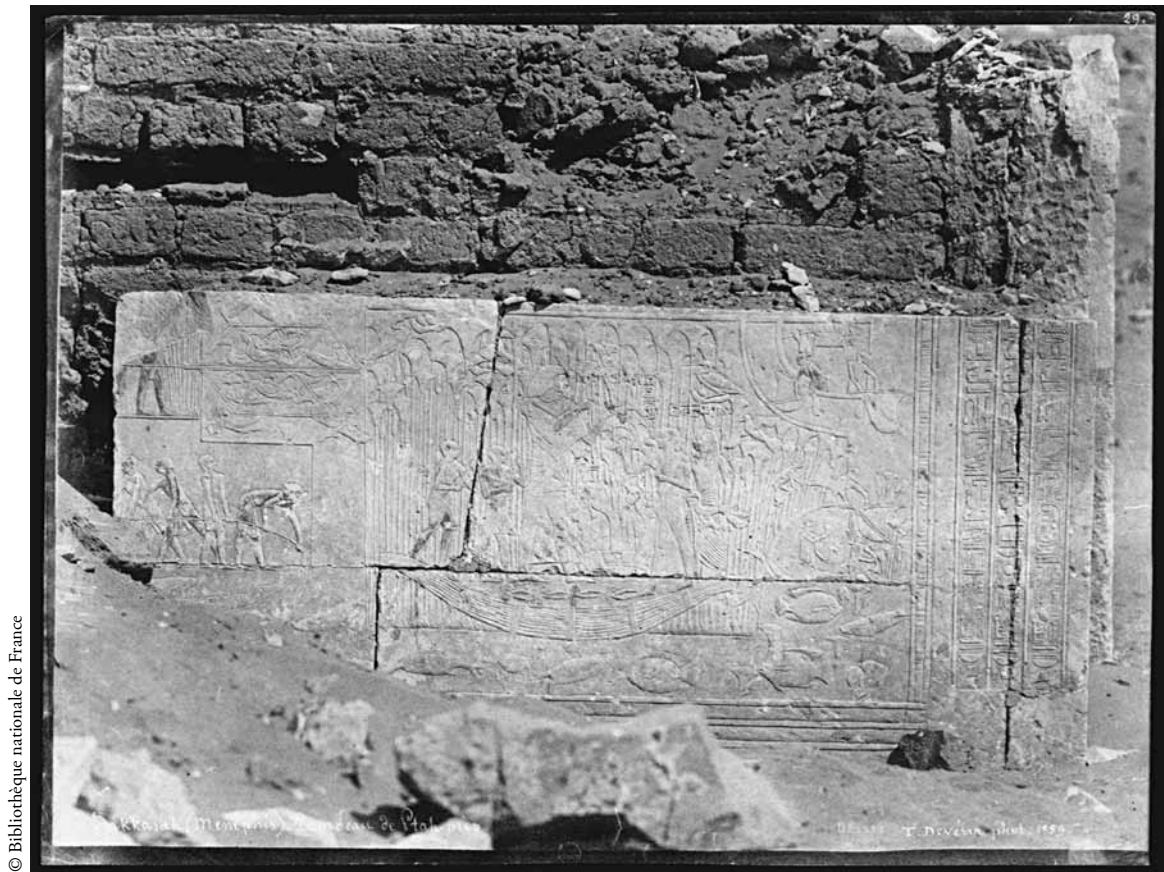

© Bibliothèque nationale de France

FIG. 4. Théodule Devéria, 1859, “Mur Rhoné”: *Sakkarah (Memphis). Tombeau de Ptàh-mes / T. Devéria.* Printed from a paper negative, 22.0 × 29.0 cm. Bibliothèque nationale de France, Département estampes et photographie, RESERVE EI-3-BOITE FOL B - n. 15.



Photo: Nico Staring

BIFAO 114 (2014), p. 455-518, Nico Staring
 FIG. 5. Andy grasping the arm of her husband, Mery-Neith. Tomb of Mery-Neith, north wall of courtyard, detail of The Tomb of Ptahmose, Mayor of Memphis Analysis of an Early 19th Dynasty Funerary Monument at Saqqara
 © IFAO 2020



© Drawing Hypogées (MAFB / M.-G. Froidevaux)

FIG. 6. Relief of Mery-Sekhmet and his wife Iwy, tomb Bubasteion I.5. Reproduced with kind permission by Alain Zivie.

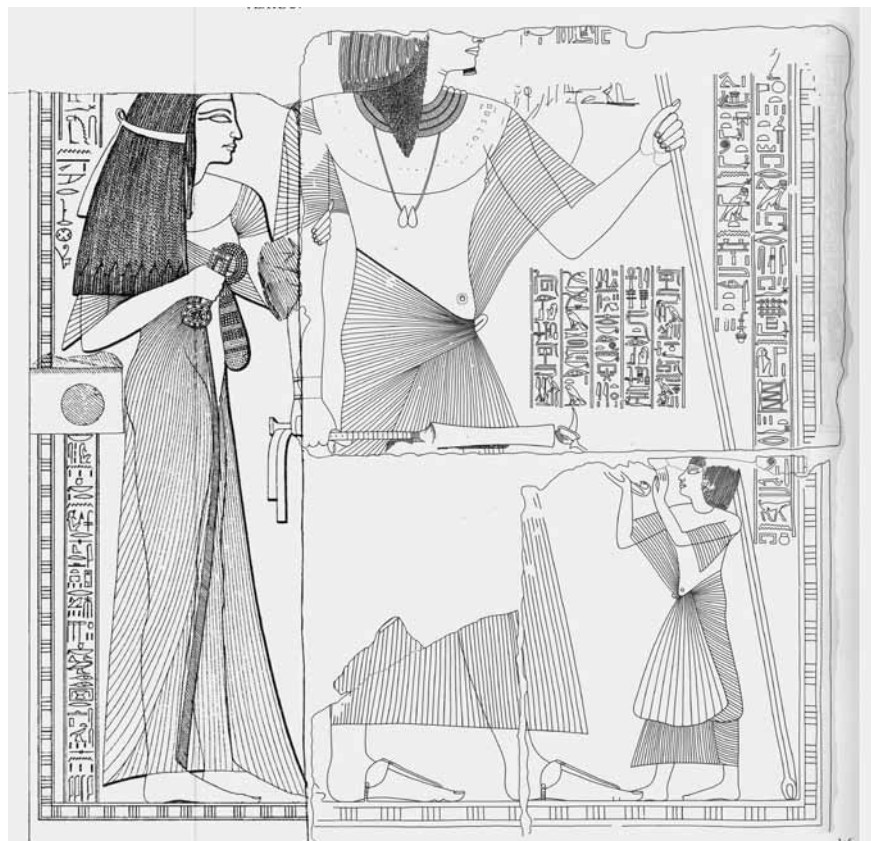

Image: Karuna Sewdas

FIG. 7. Composition line drawing of a relief depicting Maya and his wife Meryt. Tomb of Maya, south reveal of doorway into inner courtyard. After LD III, pl. 240a and G.T. MARTIN 2012, scene [30], pl. 24. BIFAO 114 (2014), p. 455-518. Nico Staring The Tomb of Pthamose, Mayor of Memphis Analysis of an Early 19 th Dynasty Funerary Monument at Saqqara © IFAO 2020

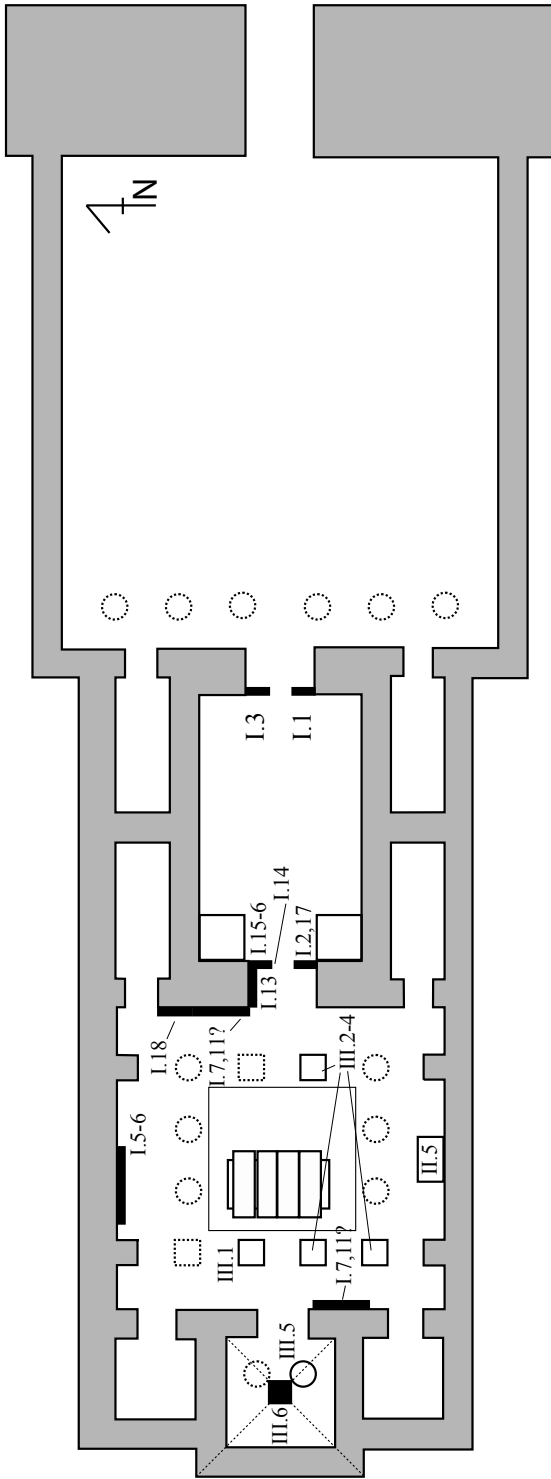

FIG. 8. Proposed positions of the Devéria doorway, “Mur Rhoné” and other elements in the hypothetical plan of the tomb of Pthamose at Saqqara, adapted from the modular grid of the tomb of Maya.

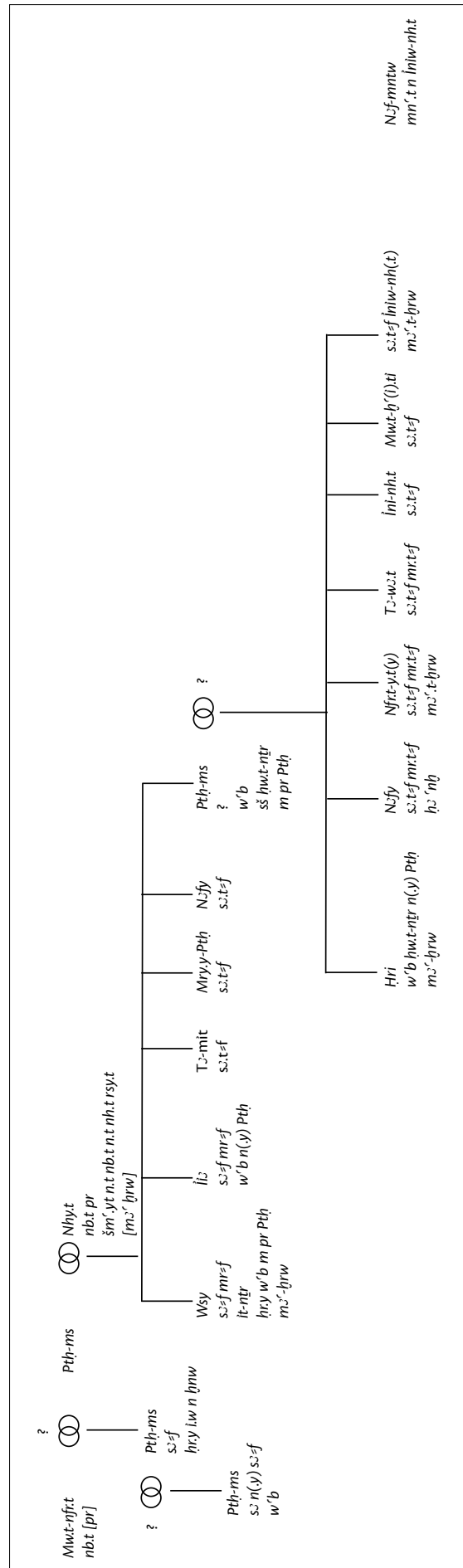

FIG. 9. Proposed family tree of Pthamose.