

PAPER • OPEN ACCESS

Refurbishment concepts for a student housing at the Otto Wagner Areal in Vienna under the aspects of sustainability, energy efficiency and heritage protection

To cite this article: E Elnagar *et al* 2021 *IOP Conf. Ser.: Earth Environ. Sci.* **863** 012047

View the [article online](#) for updates and enhancements.

You may also like

- [Application of Field Survey and Graphic Language in Cultural Relics Building—Taking Liuzi Temple as an Example](#)
Shuyuan Tong, Yafeng Zhu and Zhe Li
- [Searching for Bionics Structural Forms Optimization](#)
Ewelina Gawell, Anna Nowak and Wiesaw Rokicki
- [HAM Analysis of Selected Wooden-Framed Walls](#)
P Durica, V Kabatova, P Juras et al.



IOP Publishing
**ENVIRONMENTAL
RESEARCH
2021**
A VIRTUAL CONFERENCE
15–19 NOVEMBER

FREE TO
ATTEND

REGISTER
NOW

Refurbishment concepts for a student housing at the Otto Wagner Areal in Vienna under the aspects of sustainability, energy efficiency and heritage protection

E Elnagar^{1,*}, S Munde² and V Lemort¹

¹ Thermodynamics Laboratory, Aerospace and Mechanical Engineering Department, Faculty of Applied Sciences, Université de Liège, Belgium

² Faculty of Engineering and Architectural Science, Ryerson University, Toronto, Canada

* Corresponding author, Essam.Elnagar@uliege.be

Abstract

For the Otto Wagner area which is situated in the west of Vienna, one pavilion is selected to be refurbished for sustainable and energy-efficient construction to simulate the thermal and energy performance of the building. The selected pavilion has been redesigned to be used as a student residence while preserving the cultural heritage. A dynamic building simulation model is used to improve the energy efficiency and liveliness of Otto Wagner area with the main focus on heritage conservation. The pavilion of four levels is re-designed according to the proposed regulations of plus energy university building to become a student residence. The energy demand can be decreased while preserving the buildings' heritage requirements. Various changes are made through Sefaira tool in SketchUp model: optimization of the U-values of roof, walls and floor, addition of different layers of sustainable energy efficient insulation materials to decrease the overall energy demand, vacuum insulated panels and rigid cellulose board used to maintain existing roofline and calcium silicate boards to allow for vapor permeability in the brick walls, all working towards achieving the standards of zero energy buildings in Austria. The specific energy demands for heating, cooling and lighting are decreased in the proposed model to reduce the overall energy demand. The main goal of this study is achieving a plus energy district for the entire Otto Wagner area by improving the building envelope and integrating renewable energies using Polysun simulation tool. The selected building achieved the standards of zero energy buildings in Austria by optimizing the energy performance and to assess the thermal comfort in the building, both natural ventilation and mechanical ventilation are used to reduce the summer loads.

Keywords low energy buildings; sustainable materials; renewable energies; thermal comfort; heating demand; historical retrofit

1. Introduction

The preservation of the built cultural heritage has been an area of scientific research in the European countries since the nineteenth century. Architects, engineers, building scientists, and heritage scientists rectify historic buildings by improving the thermal and energy performance. In most European energy performance of buildings directive (EPBD) requirements, historic buildings are currently exempted but there is a growing awareness for the heritage protection and to decrease the gap between the cultural heritage and energy efficiency. Historic buildings will only survive if there is improvement in energy performance and thermal comfort, by reducing energy consumption and carbon emissions. Heritage buildings are a significant component of European architectural culture. In Europe, the percentage of



historical buildings, older than 1945, ranges from “6.1% (Turkey) and 47.4% (Luxemburg) with a mean value of 23.1%” of the total building stock of Europe [1]. In order to move forward and contribute to a sustainable future, it would be feasible to retrofit this existing building stock to achieve a low energy building. Demolishing and building new would not only require more embodied energy, but it would also eliminate the heritage character of the city.

This paper focuses on how net positive status would be achieved for a selected Pavilion in the Otto Wagner Areal (OWA) located about 10 km west of the centre of Vienna, Austria. Designed by Otto Wagner, the OWA includes a church and a hospital complex with 55 pavilions, dating back to 1907, with a ground floor area of 173,100m² [2]. In this study, the OWA was proposed to be the new net positive campus for the Central European University (CEU). Located in the southeast corner of the OWA complex, Pavilion 21 was selected to reach the net positive condition. For the purpose of this paper, the focus is on Pavilion 21 as a student residence as seen in figure 1. At the building level, there are many historical values which are significant to the building’s historical preservation. Majority of these encompass visible characteristics from the exterior of the building such as the overall façade, deep plaster horizontal cornices, decorative window frames, the exposed brick with plaster, and floors finished with “Mettlach Tiles” from Wienerberger [2]. There are many proposed changes made architecturally and mechanically to achieve a low energy building while maintaining its historical values while using the passive house standard as a reference. Strategies to implement this included improving the hygrothermal performance of the existing enclosure with insulation and including high performance



Figure 1: Selected Pavilion 21 at the Otto Wagner Areal

triple pane windows. Through this process, the specific heating demand is reduced to 15.6 kWh/m²/year and the specific energy demand for space heating and electricity is reduced to 54.6 kWh/m²/year. Once reduced, the energy and hot water heating demand was met through a combination of photovoltaics and thermal hot water collectors inclined at a 25° angle and located on the roof of the building set back from the edge of the deep historically prevalent cornice of the building in order to preserve its historical character. Additionally, geothermal energy is also considered

so it can also be connected to the existing grid as well. Decarbonising the heating sector is important for reducing CO₂ emissions. In Vienna, around 28% of the total CO₂ emissions are caused by the energy supply for buildings [3] and one of the most promising environmentally friendly technologies because of the potential is geothermal energy. In the last 15 years, the heating sector in Vienna has been moving towards more renewable energy sources and especially (+34% renewable energies). Combination of photovoltaic, solar collector array and geothermal is used to supply energy for the proposed building to contribute to goal 7 in the sustainable development goals (SDGs) for affordable clean energy which is one of the main aspects of this study [4].

2. Method and Results

2.1. Architecture

The choice of selecting Pavilion 21 is made due to its proximity to the public transit. Since most of the public buildings are located in the centre of the site, the buildings on the far left and right were designated for student residence use. This included Pavilion 21. When designing the building multiple goals were considered. These included creating a building with high comfort, high quality of life for the students, net-positive energy production, biophilia, and heritage protection. While keeping these main goals in

mind, the interior layout was based on providing private and public areas in the building for the students based on their behaviour.

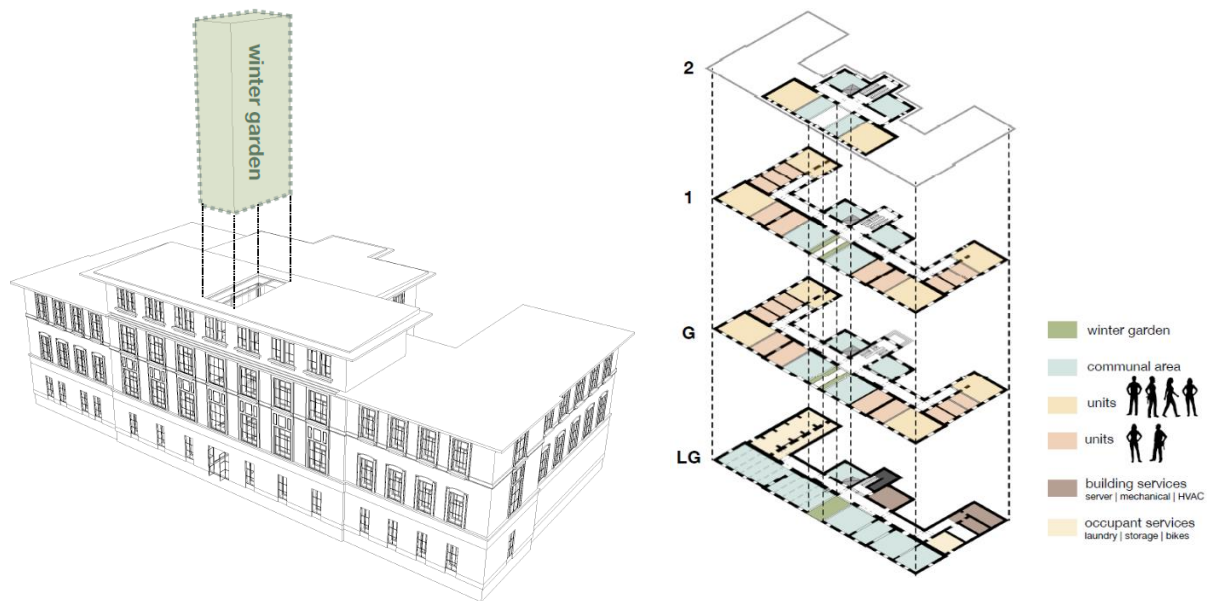

Figure 2: Proposed Interior layout and Wintergarden location.

The goals mentioned above were achieved in a multitude of ways. During the schematic design, it was decided to introduce common facilities for the students in the centre and on the lower ground floor of the building for easy access and comfort for the students. On the lower ground floor these include gym, yoga room, theatre, art workshop, bike storage and bike repair shop. On the other floors, ground to second floors, there are communal kitchens, study spaces, and lounge as seen in figure 2. These spaces promote healthy, social and a high-quality lifestyle for the students. Outdoor common spaces were designed on the rooftop as well. This allowed for the student dorms to be placed on the wings of the building resulting in symmetry. This was advantageous since the south side of the building would provide passive solar gains during the winter for the common spaces in the building. The exterior of the building was not changed and only some of the interior non-structural walls were demolished. Additionally, the existing windows were retained on the exterior and high-performance windows were placed on the interior of the building. When considering the PV and thermal solar collectors, the angle and location of the panels was carefully considered so they would not be visible from the greenspace on the south side of the pavilion and compromise the existing heritage façade of the building. The exterior of the building was modified slightly in order to accommodate wheelchair accessible entrance from the south side and a small patio for seasonal use. It was important to maintain the greenspace on the south of the building as existing since it includes mature trees. This allowed for opportunity to introduce vegetation inside the building in order to implement biophilia. An atrium with transparent PV array skylight was created in the middle of the building to provide solar exposure for the wintergarden as seen in figure 2. The wintergarden in conjunction with the passive cooling through natural ventilation during the summer creates a unique experience for the students in the building improving occupant wellness and thermal comfort. Although there is increased humidity, and CO₂ levels, this can be removed during the summertime, but would require additional mechanical ventilation during the wintertime.

In terms of the specific student units, there were two types of units proposed. Type 1 allows for accommodation up to four people and Type 2 allows up to two people as shown in figure 2. Additionally, there were also units designed for wheelchair accessibility. Between these types, this pavilion can occupy 52 students.

2.2. Enclosure

A series of changes were made to the original enclosure including the roof, ceiling, exterior walls and underground floor and wall of the building. The thermal performance of the existing building was provided from the building archives and was found to be as shown in table 1. These values are then improved resulting in lower U-values, also shown in table 1.

Table 1: U-values of existing and U-values after proposed changes

	Roof (W/m^2K)	Exterior Wall (W/m^2K)	Basement Floor (W/m^2K)	Underground wall (W/m^2K)
Existing (U-value)	2.17	0.92	3.8	0.95
New (U-value)	0.175	0.345	0.22	0.19

To achieve such results, there were modifications made to the enclosure of the building. There were 2 types of insulations used throughout this enclosure. Majority of this insulation is a rigid cellulose board which has a conductivity of $0.027 W/mK$ [5], [6]. This insulation was chosen due the fact that it is permeable and will allow any trapped water vapour in the historic masonry walls to diffuse to the interior or exterior surface, thus improving its hygrothermal function. Additionally, there was also vacuum insulated panels (VIPs) used in small areas in order to achieve a low U-value without sacrificing the thickness of the assemblies. The conductivity of VIPs is also very low. For instance, it can be as low as $0.003 W/mK$ [7]. In combination with the cellulose rigid boards, VIPs were used only at the perimeter of the roof in order to maintain the original slender roof profile as shown in figure 3a. A vapour barrier was introduced in order to prevent moisture from entering into the existing concrete roof structure. In order to have additional insulation on the ceiling, a decorative plaster with corner detail was applied in

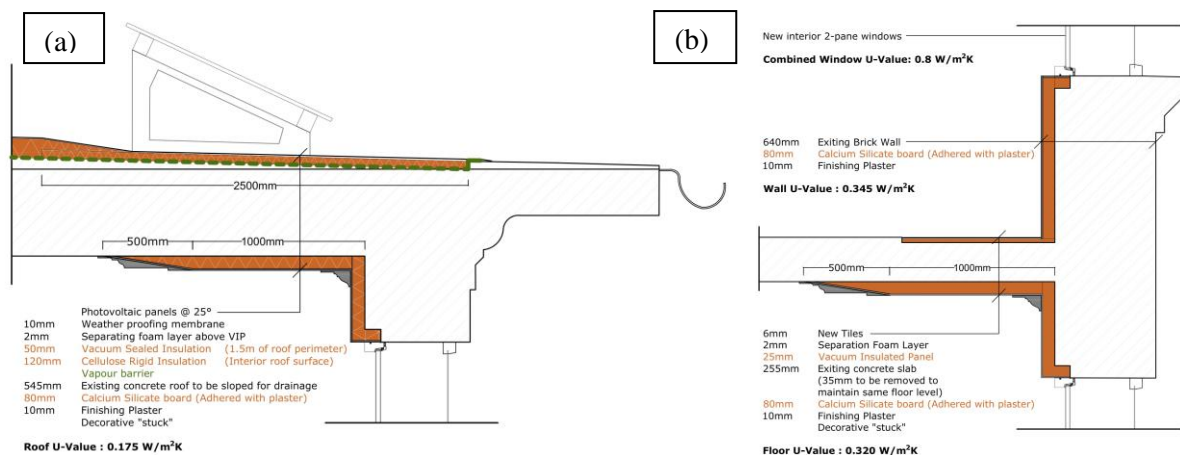

Figure 3: U-value of roof with proposed changes (a) Roof (b) floor and wall

order to blend with the existing historic building's character as seen in figure 3a. After introducing a triple pane window on the interior side in addition to the existing exterior single pane window the overall U-value was reduced to $0.8 W/m^2K$ [8]. The interior wall insulation also turns in and terminates at the base of the new window frame resulting in a thermally continuous plane as seen in figure 3a and 3b. As seen in figure 3b, moving onto the floor, a small portion of the perimeter of the floor is designed to be removed to allow the VIPs to be laid. Upon those, either the existing tile can be placed back or new "Mettlach Tiles" from Wienerberger can be placed. The existing basement floor was in poor condition based on site photographs and could be replaced by a new concrete slab. This provides an opportunity to place cellulose rigid insulation and the vapour barrier under the slab as shown in figure 4. For the

underground wall, insulation was placed on the exterior and terminates under the door frame for thermal continuity.

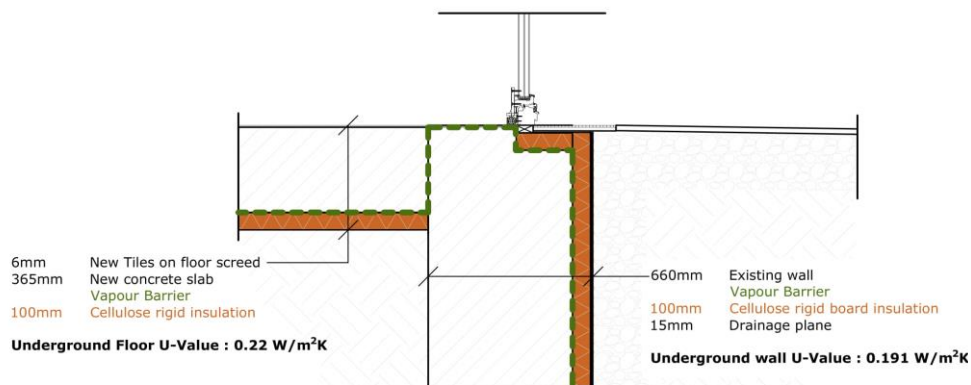

Figure 4: U-value of basement floor and wall with proposed changes

Through an iterative design process, this solution provides minimal damage with maximum improvement in thermal performance while maintaining the historical integrity of this building. Overall, a decision was made to insulate the interior of the building since it would allow for the existing building's exterior façade to remain as is for historical importance.

2.3. Simulation: Sefaira

Based on the changes made above, this data was placed in the Sefaira software. This web-based energy simulation software allowed the comparison of energy consumption between the existing building and with proposed changes. The results indicate that the existing building used 670,726 kWh/year which is 237 kWh/m²/year and the proposed building used only 168,940 kWh/year which is 54.6 kWh/m²/year. It can be seen that the majority of the energy is consumed for heating, lighting, and equipment in figure 5, however the heating was reduced from 139.5 kWh/m²/year down to 15.6 kWh/m²/year which is close to the passive house standard of 15 kWh/m²/year [9]. Similarly, the interior loads, lighting and equipment was reduced from 48 kWh/m²/year down to 21 kWh/m²/year. This reduced operational energy value results in less energy required to be produced onsite.

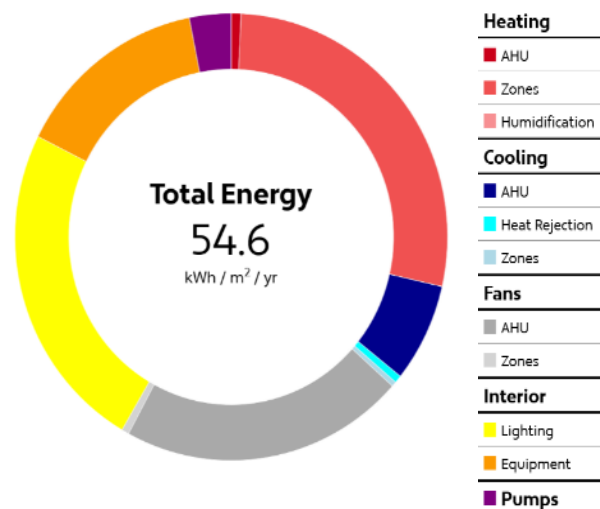

Figure 5: Overall energy breakdown of proposed design.

2.4. Energy System Simulation: Polysun

A space heating system with seasonal storage and PVT collector combined with a loop earth collector as a source of geothermal energy was designed using Polysun tool. The system was designed to cover the total heating demand of 48,82 kWh excluding DHW demand, the building specifications are shown in table 2. The annual electricity consumption is 82,410 kWh and the total energy consumption is 65,956 kWh with a self consumption fraction of 22.5% as 18,56 kWh is provided by the PV system as shown in figure 6. The ground source loop contributes by 36,509 kWh using 200 meters loop length.

Table 2: Building Specifications

Building	-	-
Heated/air-conditioned living area	m^2	3,051
Heating setpoint temperature	$^{\circ}C$	20
Heating energy demand excluding DHW [Qdem]	kWh	48,827
Annual specific heating energy demand	$kWh/m^2/a$	16
Useful heat gain	kWh	52,285
Total energy losses	kWh	100,000

The PVT system is designed using 160 modules tilted by 25° with a collector aperture area of $264 m^2$. The performance ratio of the PVT collector is 86.2%.

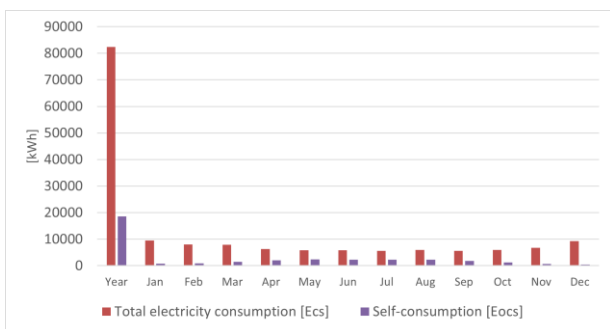

Figure 6: Total electricity consumption and self consumption of the building

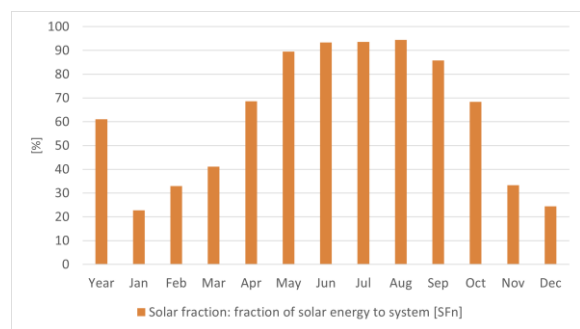

Figure 7: Fraction of solar energy to the system

Almost 61% of the hot water demand is produced by the solar thermal energy system by using 20 flat-plate collectors with an overall gross area of $40 m^2$. The system is designed to cover a daily consumption of hot water of 1,500 l/day with an energy demand of 24,220 kWh. As shown in figure 7, during the summer months the fraction of solar energy to the system is high. The energy system schematic is shown in figure 8 below.

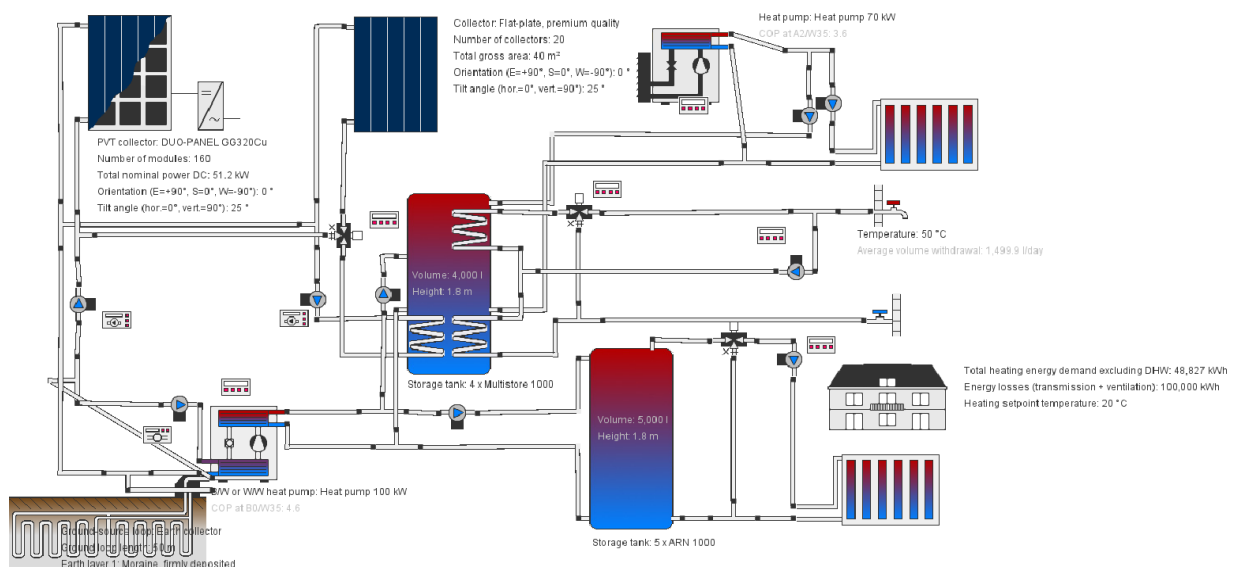

Figure 8: Energy system schematic (Space heating with a seasonal storage and PVT collector)

2.5. Future climate change implications

The effect of climate change on historical buildings has been examined previously. Climate change will result in an increase in temperature and a change in the pattern of rainfall. Energy use, indoor climate and humidity dynamics of historic buildings can be changed along with retrofit solutions [10]. Overheating is already a growing concern in with regard to the internal climate. The combined effect of internal insulation and increased outdoor temperatures may increase the energy demand for cooling and encourages the implementation of cooling and ventilation systems for the historical buildings.

The impact of the changing climate for pavilion 21 would be much less compared to buildings located the dense city's center. Since the OWA is located outside of central Vienna, there is a lower impact of the Urban Heat Island effect (UHI), resulting in a lower cooling demand in the summer. Since passive cooling with natural cross ventilation is proposed by taking advantage of north prevailing winds on site, this may be sufficient to accommodate for the changing climate in the future but would require further modelling with future weather files to be certain. Additionally, there is a large greenspace towards the north and large mature trees around the site and complex which were kept as existing as shown in figure 1. Therefore, through the process of evapotranspiration, the surrounding area is further cooled to reduce the summer cooling load. Since the proposed changes made to the building result in interior insulation, during the summertime this may be problematic. Although the proposed insulation is vapour permeable, during the summertime, the sun would drive the moisture towards the interior surface of the envelope. This may lead to insulation degradation or reduced performance if the moisture within the wall is not able to dry out towards the interior quickly.

3. Discussion

The architectural interventions proposed in this case study provide a balance of private, public, and semi-public areas for the students. However, some difficulties may arise during the actual construction process with unknown issues due to the age of the building. For example, more interior walls may be required than anticipated in order to ensure structural safety. Since PV and thermal solar collectors are proposed to be the dominant method of producing energy on site, this would require approval from municipal authorities. Further on-site investigation and testing would be required in order to determine if any of the proposed interventions may cause problems in reality. Since this is an existing building, the air infiltration will not be low as a newly constructed building. This would increase the heat loss in reality in comparison to this virtual study conducted. It would also be difficult to predict other challenges which may take place on site during renovation since this is an old building existing from the early 1900s. It becomes very difficult to simulate these unforeseen challenges which may compromise the building's thermal performance.

Overall, in order to achieve a low energy building, reducing the initial consumption as much as possible is an essential first step. Working with this building's historic restrictions, the changes were made to allow the maintenance of the existing building as much as possible while incorporating an improved thermal resistance. Based on the proposed measure, the specific characteristics of historical value were preserved. From the exterior, the façade including the windows, cornice and exposed brick/stone/plaster all remain unchanged. From the interior, the plaster finish over the insulation would maintain the interior finish as per the existing design as well. Only a small portion of the original floor tiles would be removed but can be replaced by the original supplier. Additionally, the tilt angle of the PV array is also designed not to be seen from people walking up to the pavilion. As a result, the historic values of the building are preserved.

4. Conclusions

In conclusion, multiple aspects are required to retrofit an existing historical building in order to achieve a net-zero energy status. Architectural interventions were incorporated in order to preserve heritage, improve quality of life, create opportunity for biophilia with a wintergarden and design with sustainability. The flexible room typologies allow for wheelchair accessibility and can accommodate up to 52 students. The solutions presented in this paper include improving the thermal performance of the

enclosure while maintaining the historic character of the building through the use of VIPs and cellulose rigid board insulation. This resulted in the overall energy consumption of the building to be reduced to 55 kWh/m²/year from 237 kWh/m²/year. Although it is difficult to anticipate on site conditions and simulate the existing airtightness levels, the proposed changes provide a good starting point for retrofits for historic buildings in the European context where majority of the cities are already built. If applied to the whole Otto Wagner Areal, this can develop an innovative infrastructure and encourage other campuses to integrate these strategies as well.

These strategies can be applied to achieve the sustainable development goals, 5 SDGs are achieved in this study. Moving towards providing clean and affordable energy, as outlined in goal 7, is demonstrated in this study with the use of PV, solar hot water collectors, ground source heat pump to power the building after reducing the energy demand as much as possible resulting in significantly reduced energy bills. In addition to this, cellulose insulation was selected since it is an organic material to contribute towards goal 9 for industry, innovation and infrastructure. This project also encourages students to bike, use the gym and yoga room, which will provide employment for the students, thus contributing towards goal 3 and 8 regarding good health & well-being and decent work & economic growth [4]. Factors included in this design also contribute to goal 11 for sustainable cities and communities[4]. Moving forward, these strategies in combination with others pave the way for a sustainable future for retrofitting historical buildings.

5. References

- [1] Effesus, "Deliverable D1.1: European building and urban stock data collection - Energy Efficiency for EU Historic Districts Sustainability," 2013. [Online]. Available: http://www.effesus.eu/wp-content/uploads/2016/01/D-1.1_European-building-and-urban-stock-data-collection.pdf.
- [2] K. Stieldorf, M. Turrini, and GBS 2020 Participants, "Otto Wagner Areal Plus - Green Building Solutions 2020 Design Projects." OeAD student housing, Feb. 02, 2021, Accessed: Feb. 20, 2021. [Online]. Available: https://issuu.com/barbara.mayr/docs/owa_booklet_complete_20210121_final.
- [3] C. Tissen *et al.*, "Identifying key locations for shallow geothermal use in Vienna," *Renewable Energy*, vol. 167, pp. 1–19, Apr. 2021, doi: 10.1016/j.renene.2020.11.024.
- [4] United Nations, "THE 17 GOALS | Sustainable Development." <https://sdgs.un.org/goals>.
- [5] P. Wang, N. Aliheidari, X. Zhang, and A. Ameli, "Strong ultralight foams based on nanocrystalline cellulose for high-performance insulation," *Carbohydrate Polymers*, vol. 218, pp. 103–111, Aug. 2019, doi: 10.1016/j.carbpol.2019.04.059.
- [6] B. Pierson, "Cellulose rigid foam board Insulation, environmentally-friendly styrofoam alternative," *ecohome*, May 24, 2019. <https://www.ecohome.net/news/1465/cellulose-foam-insulation-boards/> (accessed Jan. 05, 2021).
- [7] A. Capozzoli, S. Fantucci, F. Favoino, and M. Perino, "Vacuum Insulation Panels: Analysis of the Thermal Performance of Both Single Panel and Multilayer Boards," *Energies*, vol. 8, no. 4, pp. 2528–2547, Mar. 2015, doi: 10.3390/en8042528.
- [8] "Rustic Profile Wood Windows» Custom Built with Glazing Bars | neuffer-windows.ca." <https://www.neuffer-windows.ca/wood-window-rustic.php> (accessed Jan. 04, 2021).
- [9] "Passivhaus Institut." https://passiv.de/en/02_informations/02_passive-house-requirements/02_passive-house-requirements.htm (accessed Jan. 05, 2021).
- [10] L. Hao, D. Herrera-Avellanosa, C. Del Pero, and A. Troi, "What Are the Implications of Climate Change for Retrofitted Historic Buildings? A Literature Review," *Sustainability*, vol. 12, no. 18, p. 7557, Sep. 2020, doi: 10.3390/su12187557.

Acknowledgments

The authors would like to thank Prof. Karin Stieldorf from TU Wien, Prof. Georg Reinberg from Reinberg Architekten ZT as well as the Green.Building.Solutions (GBS) Summer University for their valuable input and assistance during the participation in the summer university. The authors also thank Mr. Marcello Turrini from GBS team for the paper internal review and feedback, and Ms. Karina Rafailov for her input in the architectural model for this project during the summer university program.