

Neural network-based surrogate model for multi-scale analyses

Ludovic Noels, Ling Wu

University of Liege

Computational & Multiscale Mechanics of Materials

<http://www.ltas-cm3.ulg.ac.be>

-

JKU - Workshop

08 February 2021

Multi-scale simulations

- Computational homogenisation (FE2)

- Heterogeneous structures
 - Micro-scale: cell, grains, inclusions...
 - Macro-scale: seen a continuum
- Direct numerical simulations
 - Time consuming
- Idea: use multi-scale strategy

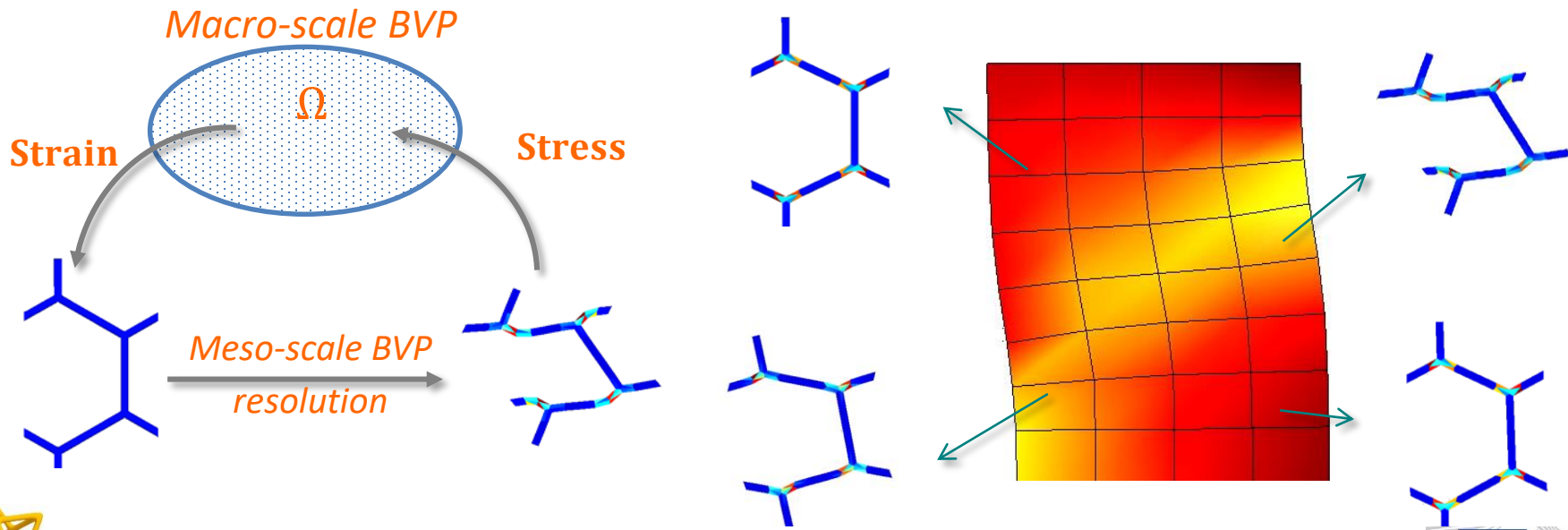
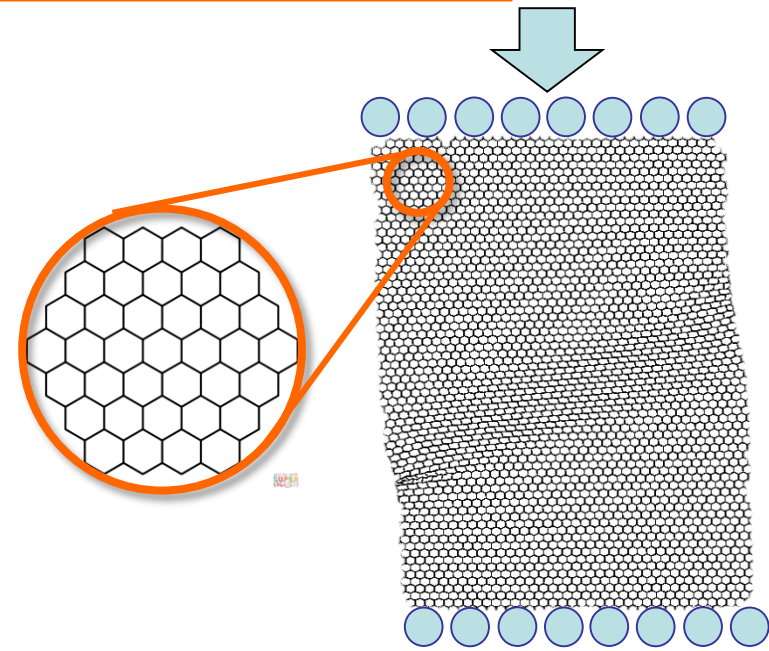

Multi-scale simulations

- Computational homogenisation (FE2)

- Non-linear simulations
 - Iterations at macro-scale BVP
 - Sub-iteration at meso-scale BVP

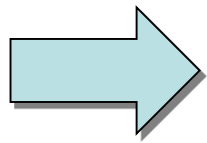

Unaffordable

- Introduction of data-driven approach
- Use of surrogate models

- Train a surrogate model (off-line)
 - Requires extensive data
 - Obtained from RVE simulations
 - Different RVE properties
- Use the trained surrogate model during analyses (on-line)
 - Speed-up of several orders

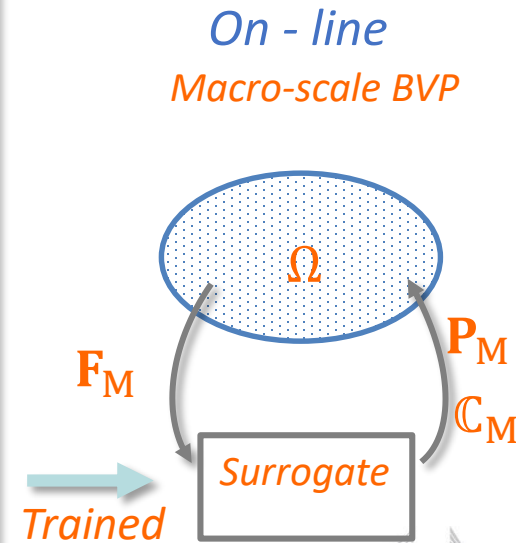
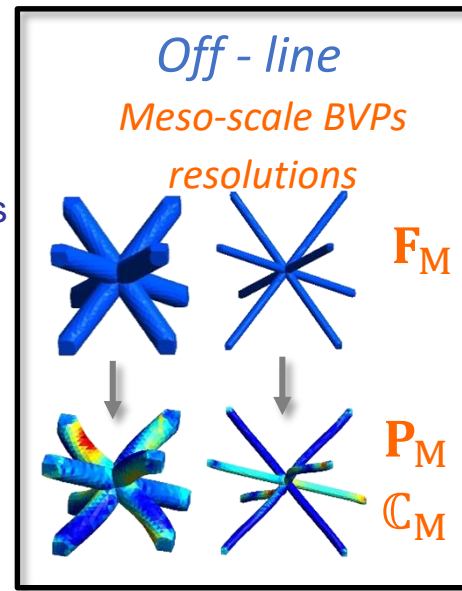
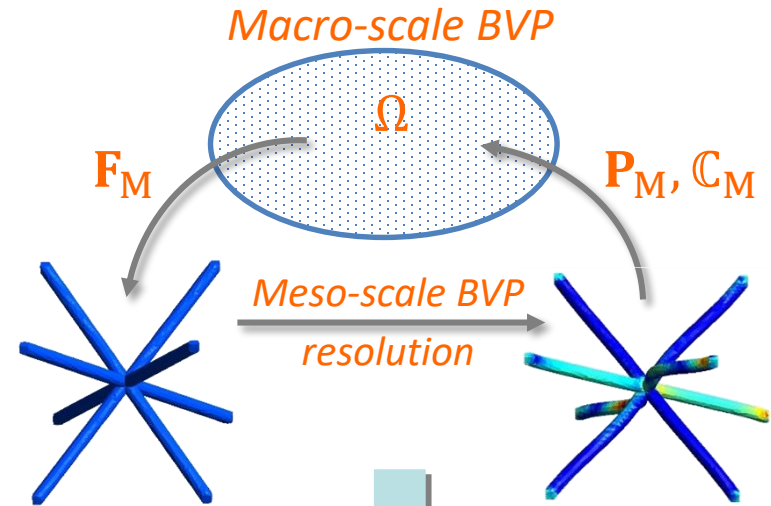

Artificial Neural Network

- Definition of the surrogate model

- Artificial neuron
 - Non-linear function on n_0 inputs u_k
 - Requires evaluation of weights w_k
 - Requires definition of activation function f
- Activation functions f

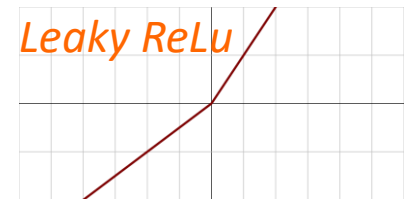
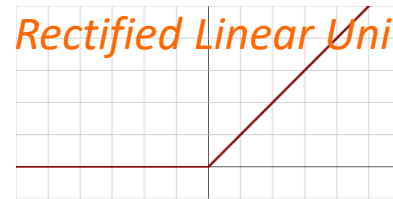
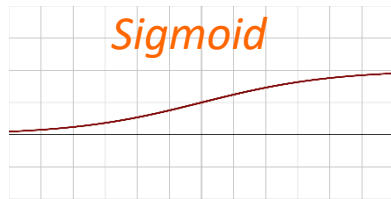
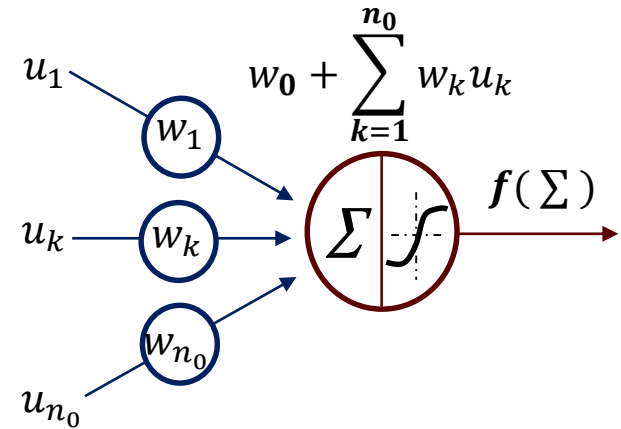

- Feed-Forward Neuron Network

- Simplest architecture
- Layers of neurons
 - Input layer
 - $N - 1$ hidden layers
 - Output layers
- Mapping $\mathcal{R}^{n_0} \rightarrow \mathcal{R}^{n_N}: v = g(u)$

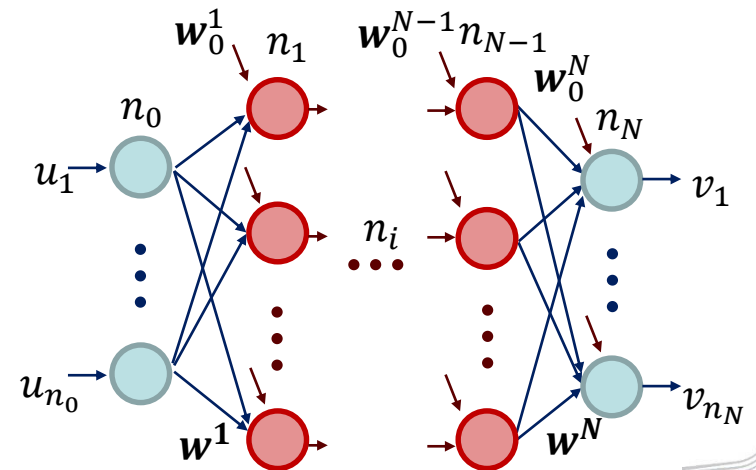

Artificial Neural Network

• Training

- Use (a lot of) known data

- Input $\mathbf{u}^{(p)}$ & Output $\mathbf{v}^{(p)}$
- Requires normalization:

$$\hat{\chi} = \frac{\chi - \bar{\chi}}{\chi_{\max} - \chi_{\min}}$$

- Evaluate

- The weights $w_{kj}^i, k = 1..n_{i-1}, j = 1..n_i$
- The bias w_0^i
- Minimise error prediction \mathbf{v} vs. real $\mathbf{v}^{(p)}$

$$L_{\text{MSE}}(\mathbf{W}) = \frac{1}{n} \sum_i^n \left\| \mathbf{v}_i(\mathbf{W}) - \mathbf{v}_i^{(p)} \right\|^2$$

- Requires an optimizer:
Stochastic Gradient Descent

$$\Delta \mathbf{W} = -\mathcal{F} \left(\frac{\partial L_i(\mathbf{W})}{\partial \mathbf{W}}, \left(\frac{\partial L_i(\mathbf{W})}{\partial \mathbf{W}} \right)^2, \text{batch size, ...} \right)$$

• Testing

- Use new data

- Input $\mathbf{u}^{(p)}$ & Output $\mathbf{v}^{(p)}$
- Verify prediction \mathbf{v} vs. real $\mathbf{v}^{(p)}$

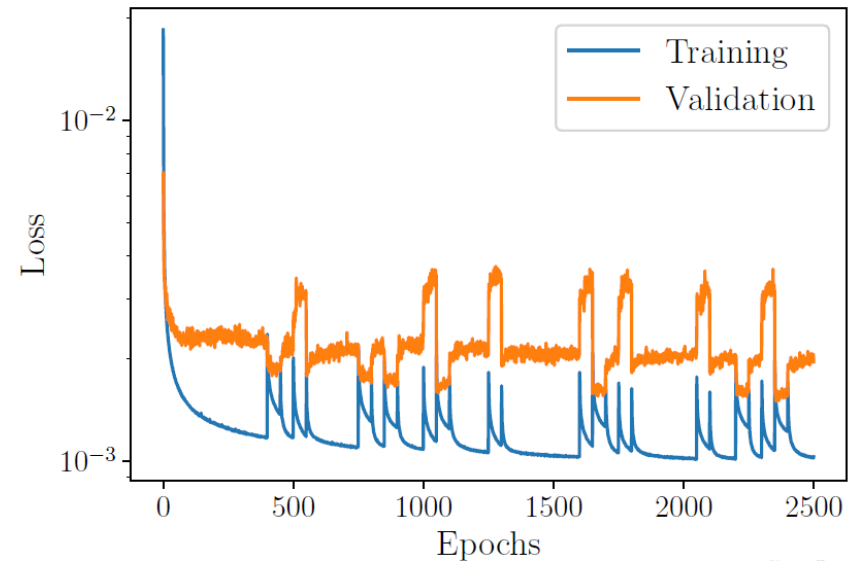
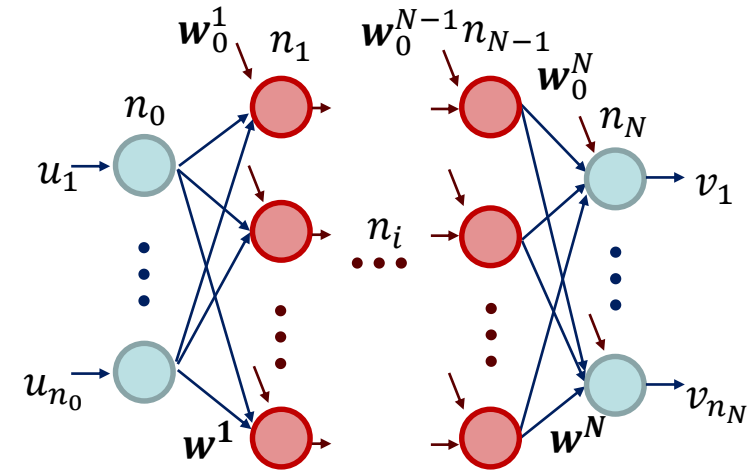

- Input / output definition

- Input:

- Strain (history): \mathbf{F}_M
 - Geometry/material parameters: φ_m

- Output:

- Stress (history): \mathbf{P}_M

- Methodology

- Address problem of history dependency

- RVE without buckling
 - Elasto-plastic composite RVE

- Address problem of geometry/material effect

- Octet cells
 - Elastic material at first

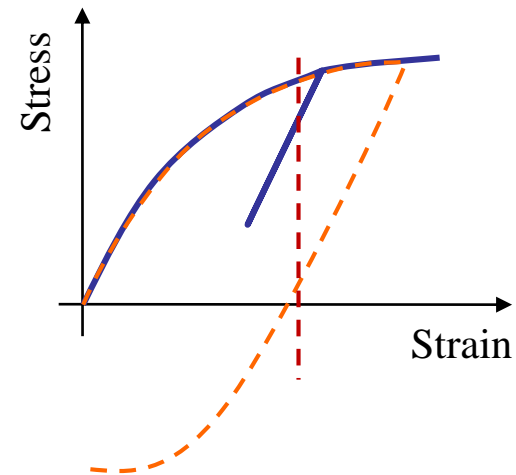
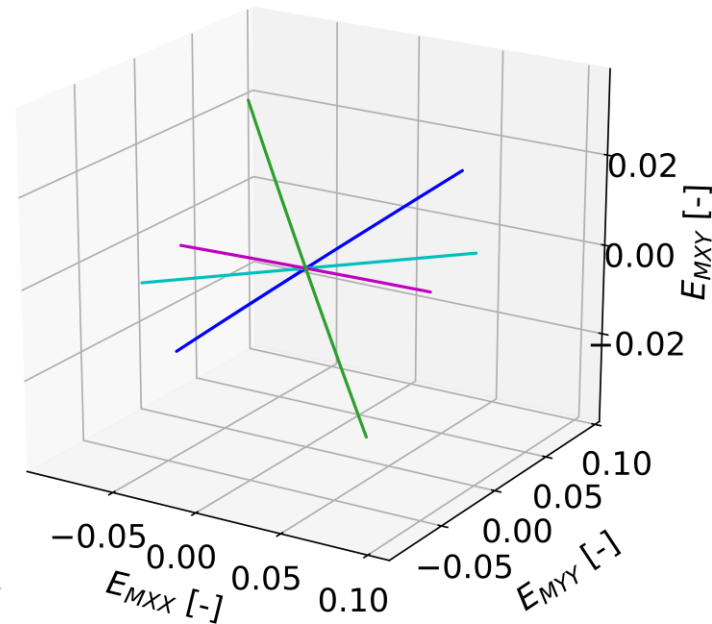

History dependency

- Elasto-plastic material behaviour

- No bijective strain-stress relation
 - Feed-forward NNW cannot be used
 - History should be accounted for

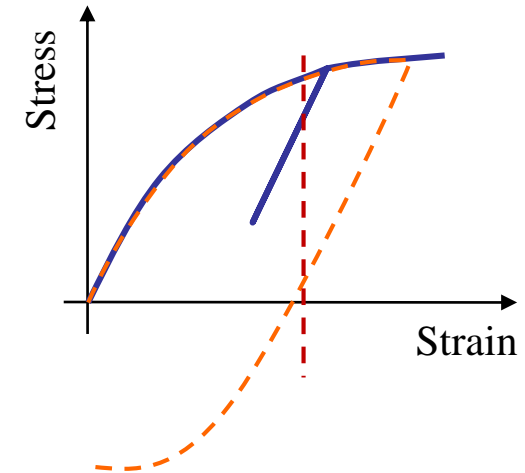

- Recurrent neural network

- Allows a history dependent relation
 - Input \mathbf{u}_t
 - Output $\mathbf{v}_t = \mathbf{g}(\mathbf{u}_t, \mathbf{h}_{t-1})$
 - Internal variable $\mathbf{h}_t = \mathbf{g}(\mathbf{u}_t, \mathbf{h}_{t-1})$
- Weights matrices $\mathbf{U}, \mathbf{W}, \mathbf{V}$
 - Trained using sequences
 - Inputs $\mathbf{u}_{t-n}^{(p)}, \dots, \mathbf{u}_t^{(p)}$
 - Output $\mathbf{v}_{t-n}^{(p)}, \dots, \mathbf{v}_t^{(p)}$

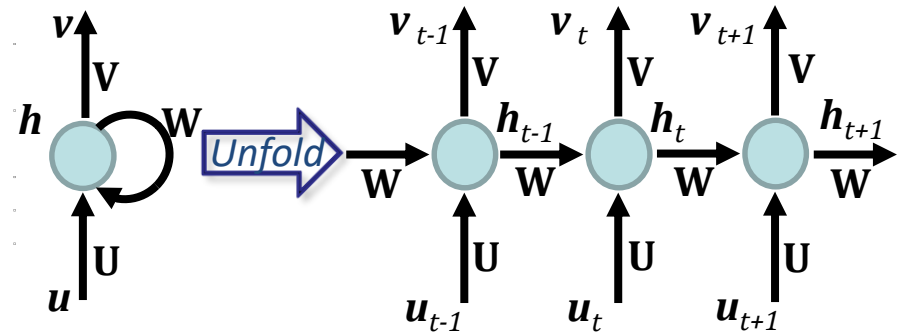

History dependency

- Gated Recurrent Unit (GRU) at a glance

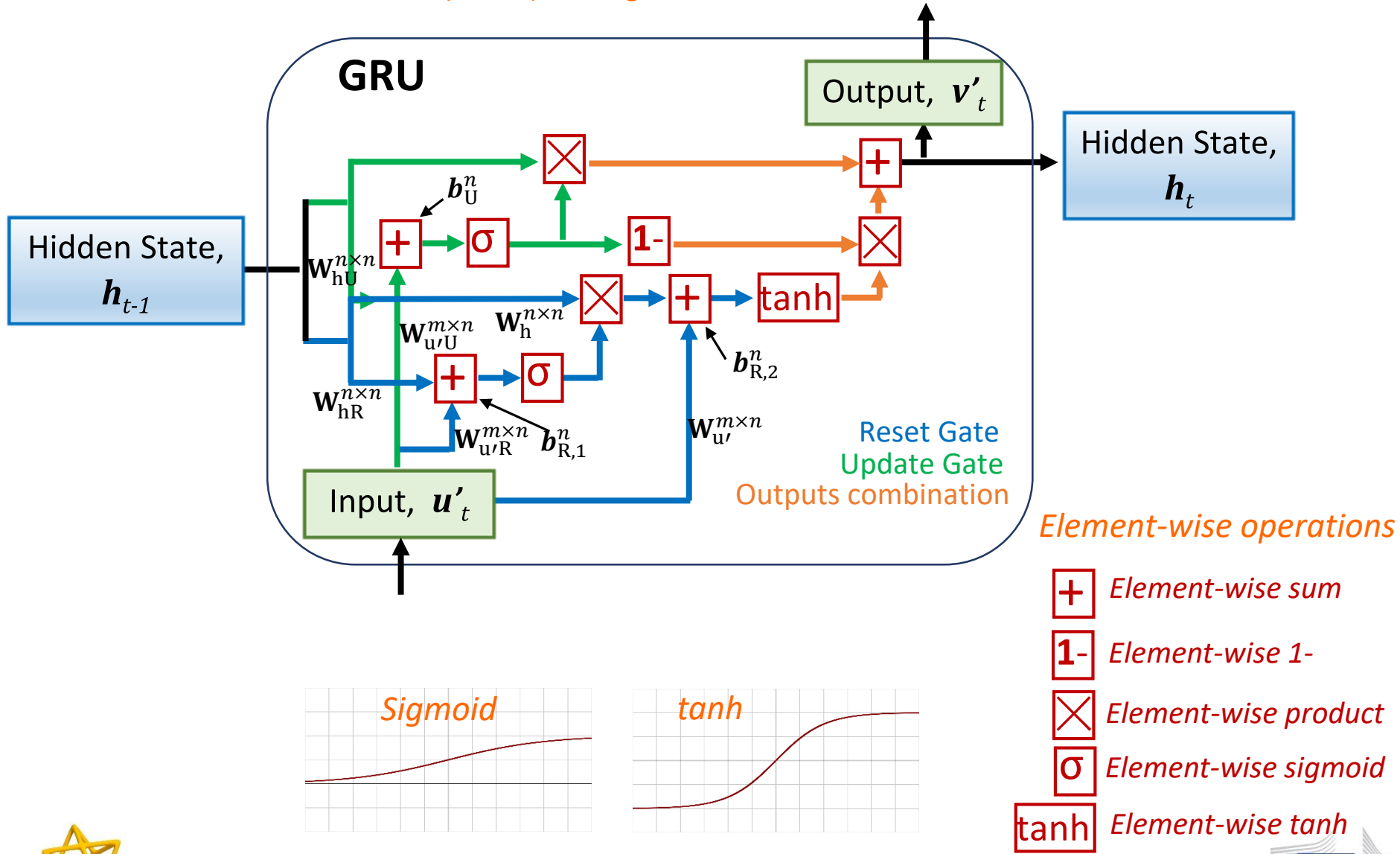

History dependency

Recurrent neural network design

- 1 Gated Recurrent Unit (GRU)
 - Rest gate: select past information to be forgotten
 - Update gate: select past information to be passed along
- 2 feed-forward NNWs (Leaky ReLU)
 - NNW_i to treat inputs u_t
 - NNW_o to produce outputs v_t
- Details
 - u_t : homogenised GL strain E_M (symmetric)
 - v_t : homogenised 2nd PK stress S_M (symmetric)
 - 100 hidden variables h_t
 - NNW_i one hidden layer of 60 neurons
 - NNW_o two hidden layers of 100 neurons

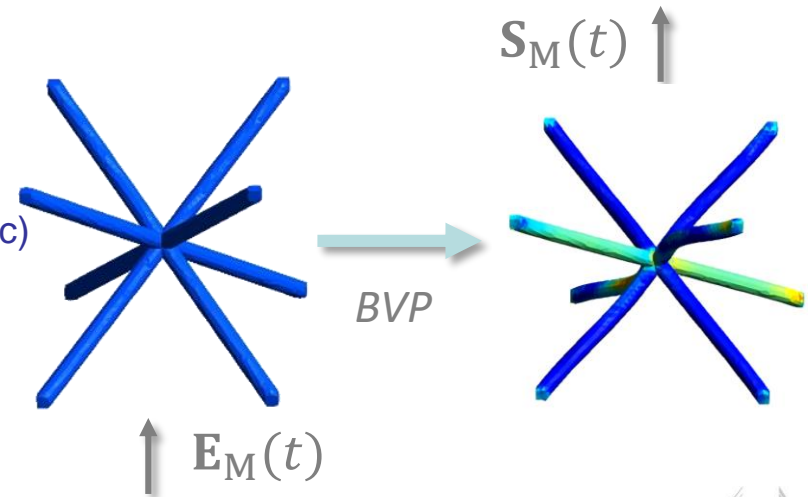
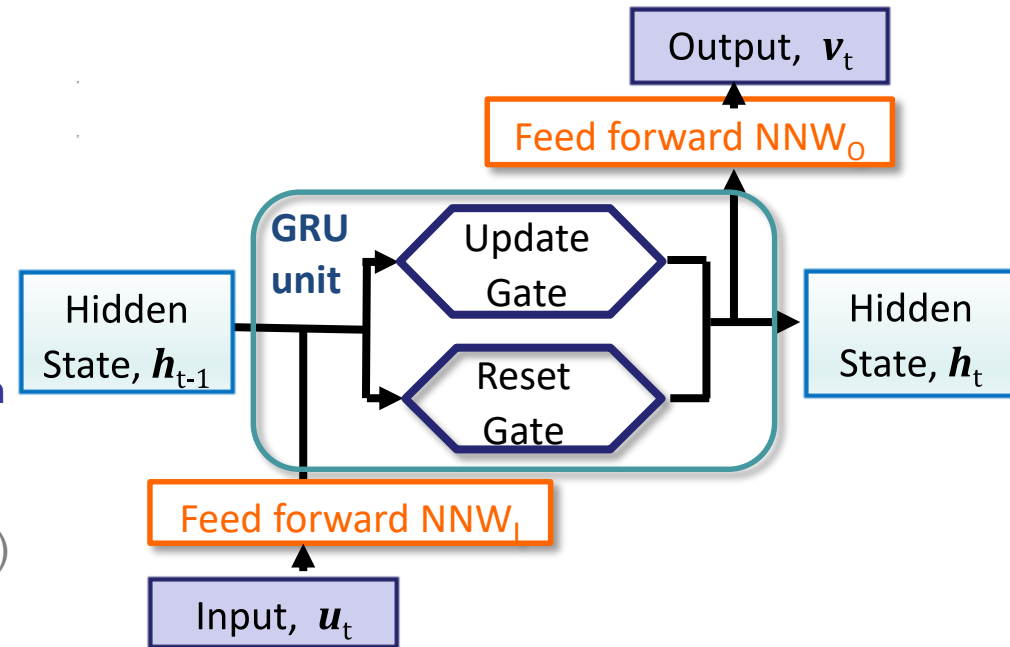

- Data generation

- Elasto-plastic composite RVE
- Training stage
 - Should cover full range of possible loading histories
 - Use random walking strategy (thousands)
 - Completes with random cyclic loading (tens)
 - Bounded by a sphere of 10% deformation

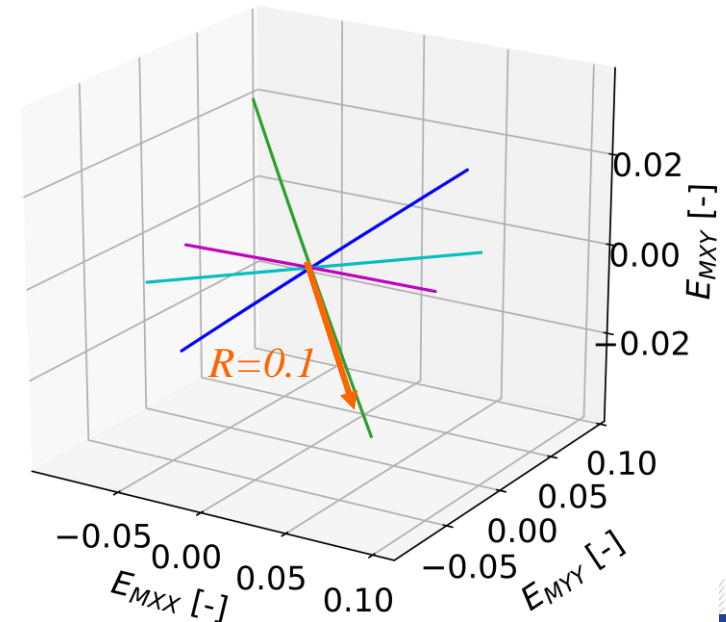
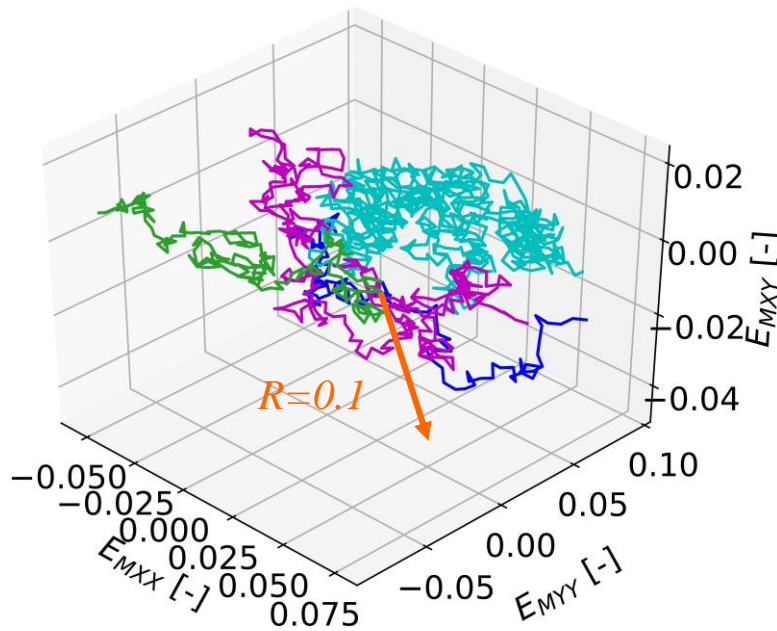
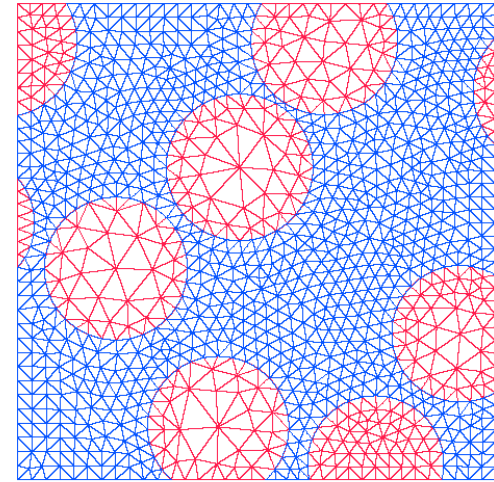

History dependency

- Testing process (new data)

- On random walk

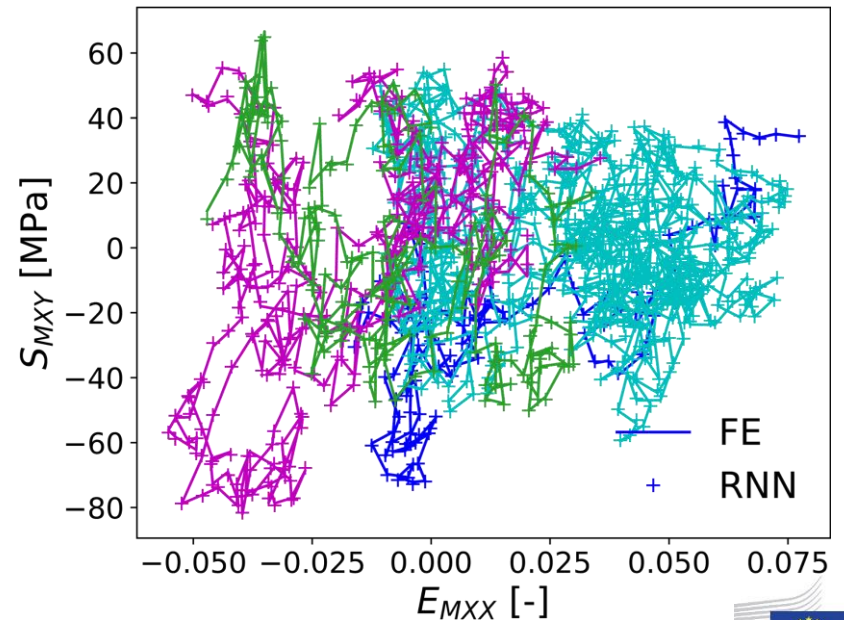
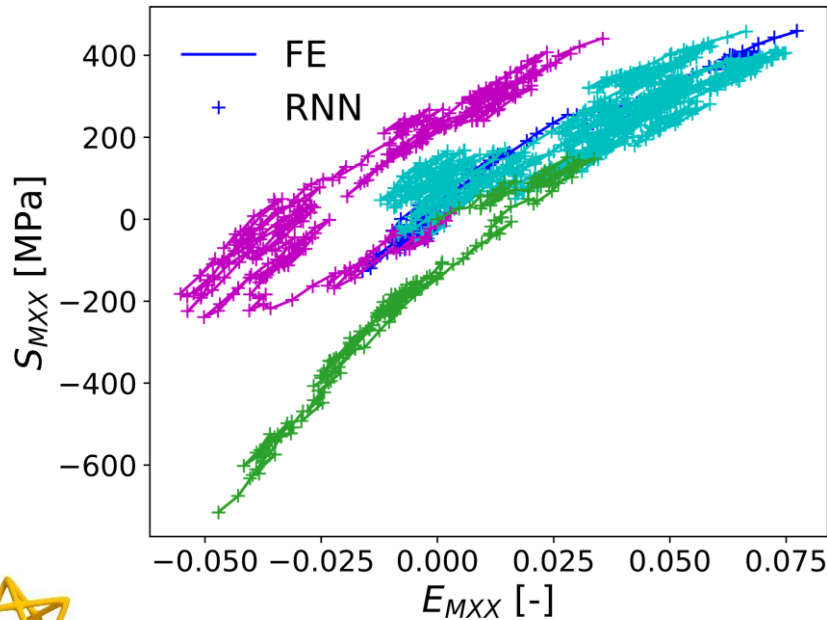
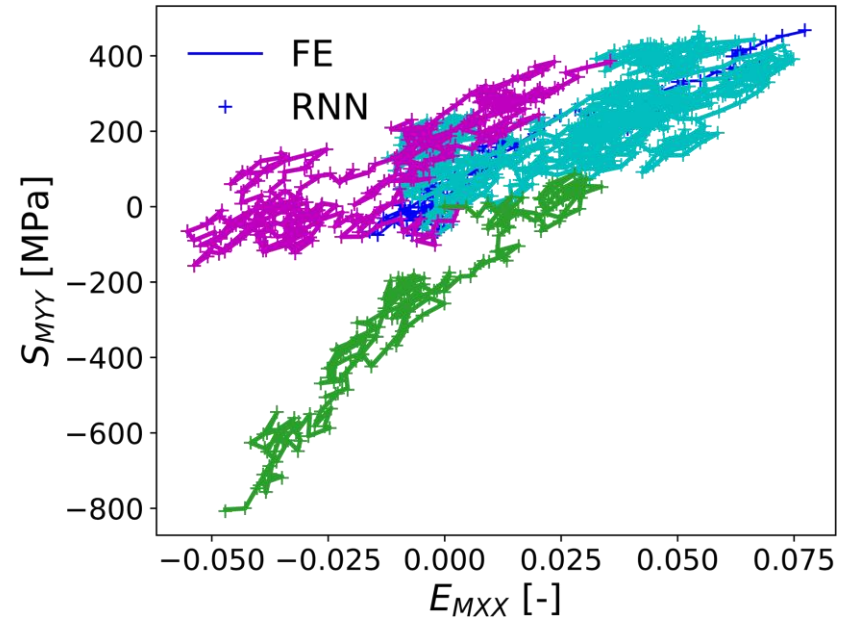
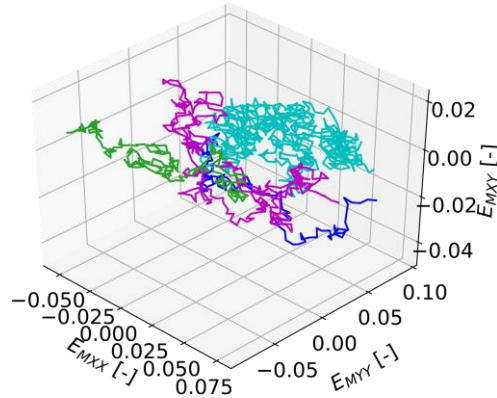
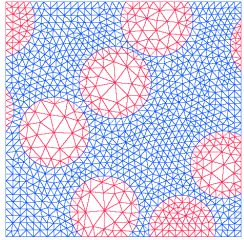

History dependency

- Testing process (new data)

- On cyclic loading

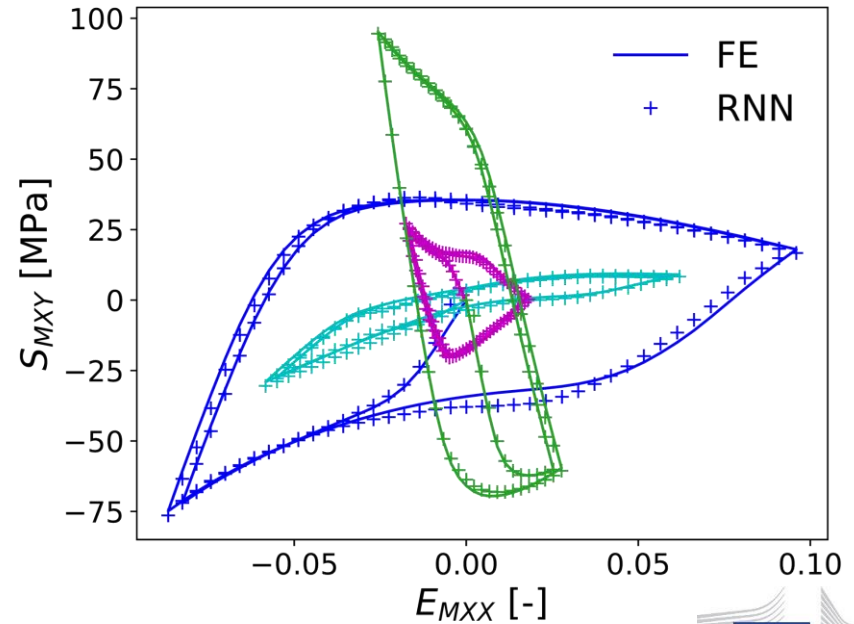
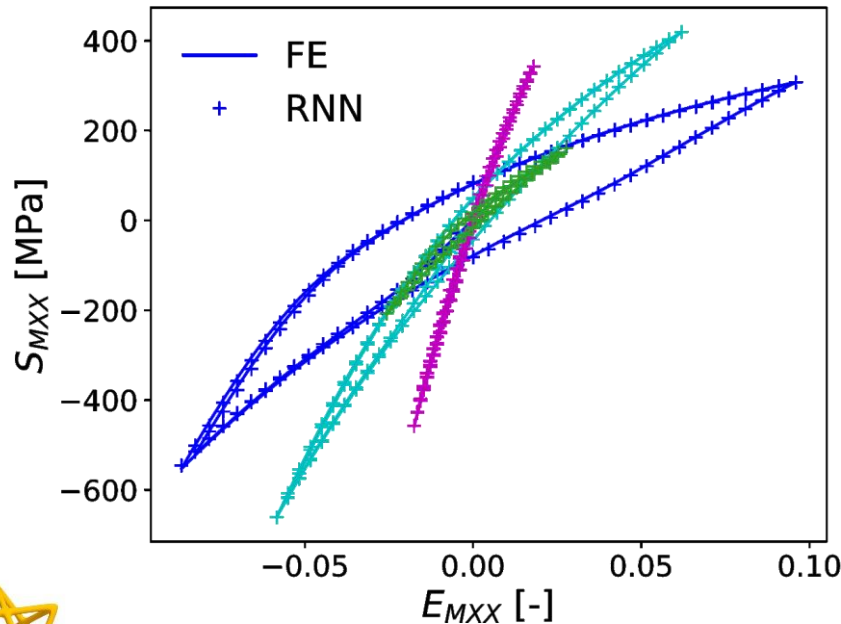
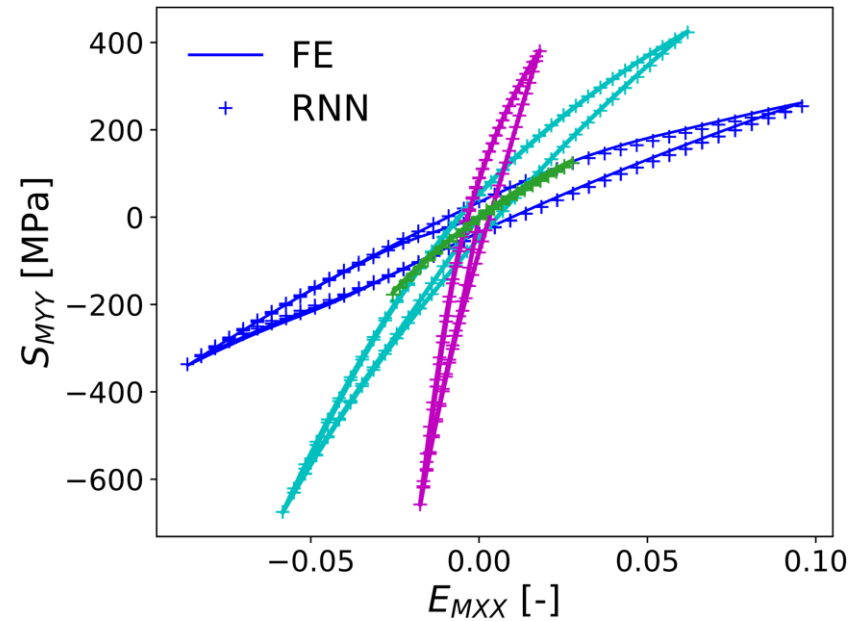
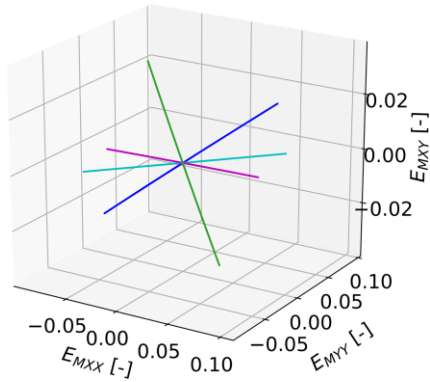
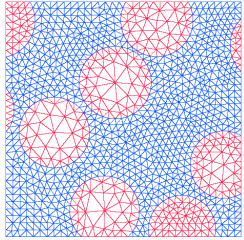

Geometrical parameters effect

- Octet cell

- Generalised IMDEA script to generate random cells and random loading paths

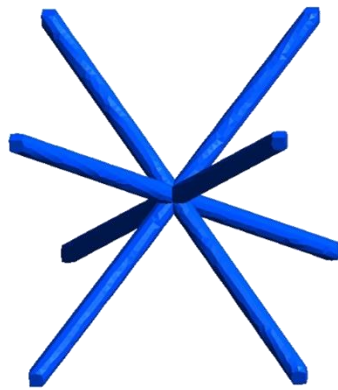

$V_f = 0.046; l=1.70 \text{ mm}$

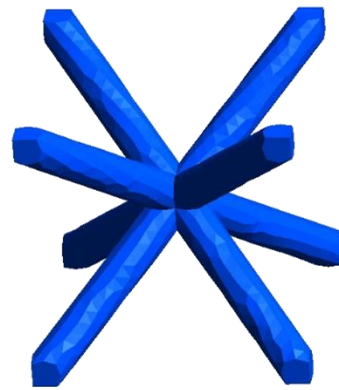

$V_f = 0.095; l=1.72 \text{ mm}$



$V_f = 0.18; l=1.50 \text{ mm}$

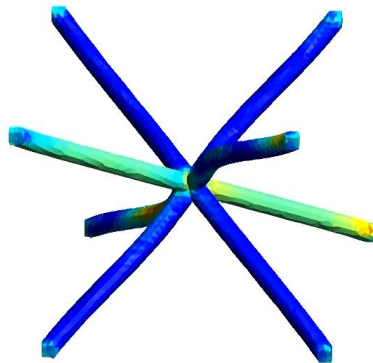

J2 [MPa]

0.013 122

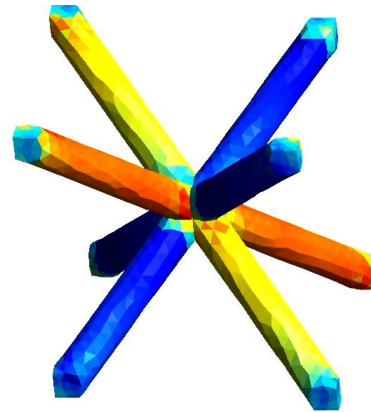

J2 [MPa]

0.0519 138

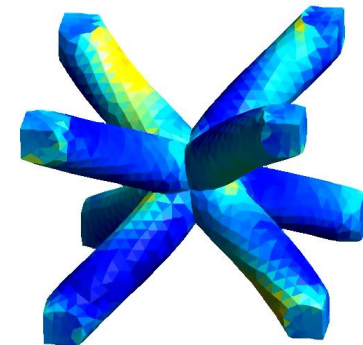

J2 [MPa]

0.0456 195



- Octet cell

– Test on new random cell/path

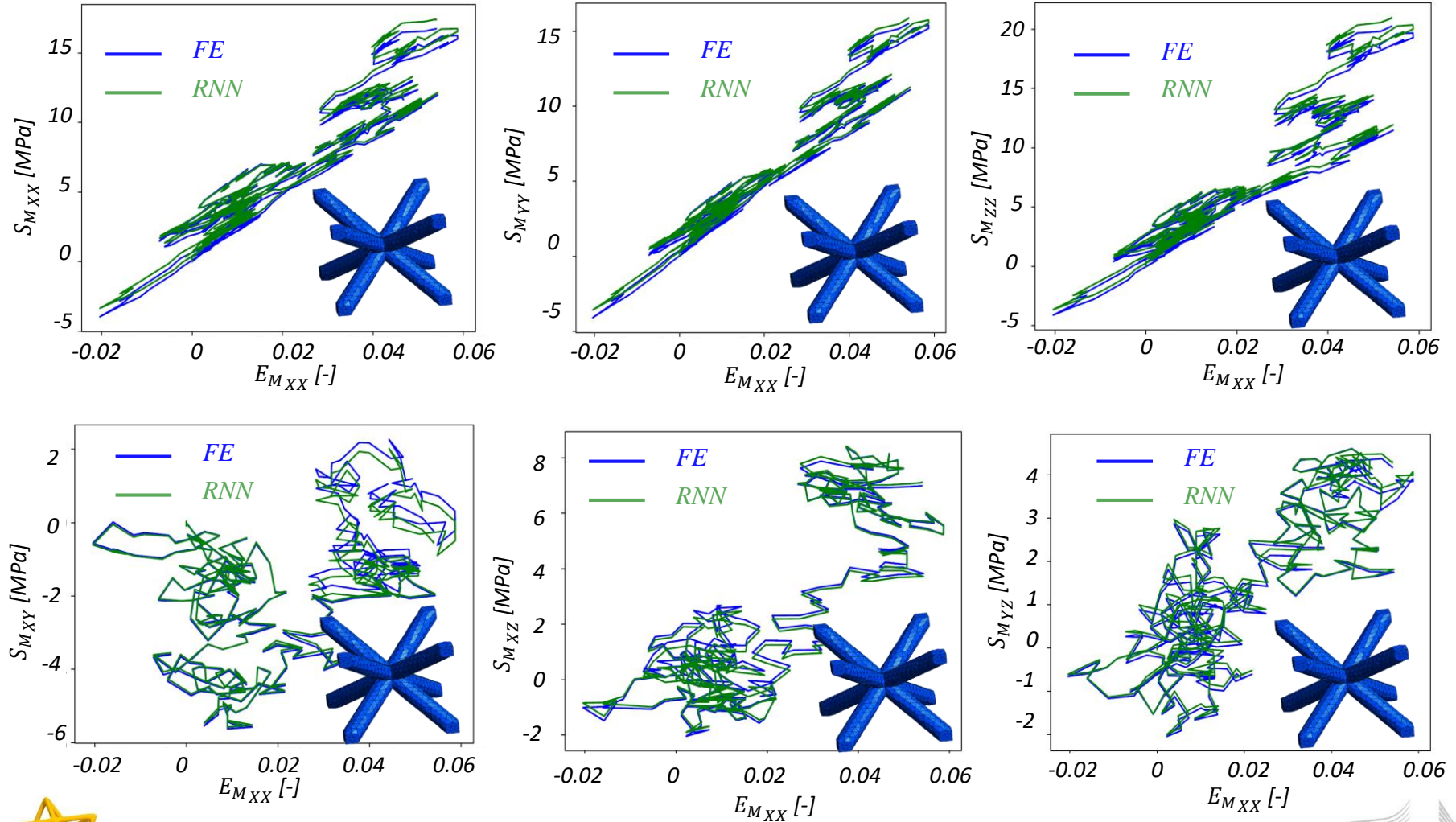

ANN as a mesoscale surrogate model

Multiscale simulation

- Elasto-plastic composite RVE
- Comparison FE^2 vs. RNN-surrogate
- Training data
 - Bounded at 10% deformation

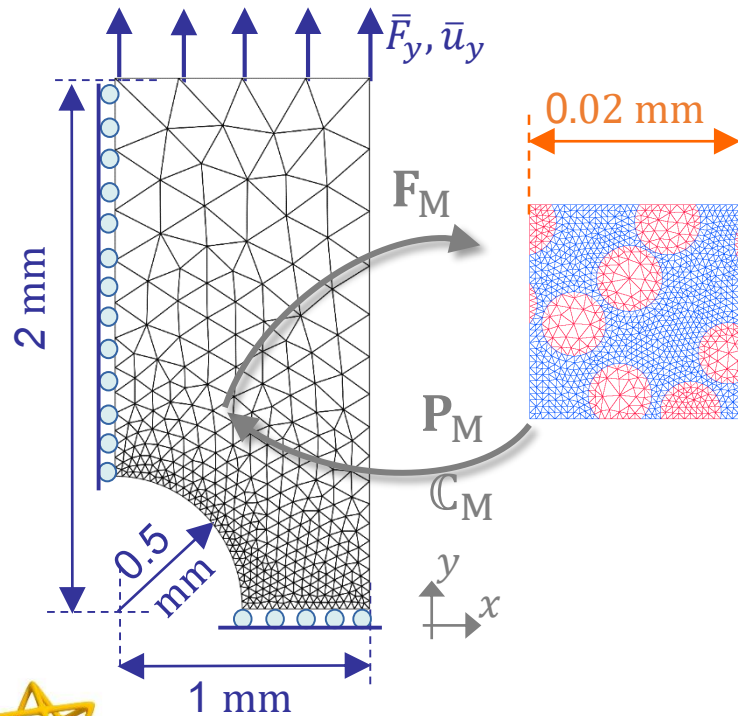

Off-line	FE^2	FE-RNN
Data generation	-	9000 x 2 h-cpu
Training	-	3 day-cpu
On-line	FE^2	FE-RNN
Simulation	18000 h-cpu	0.5 h-cpu

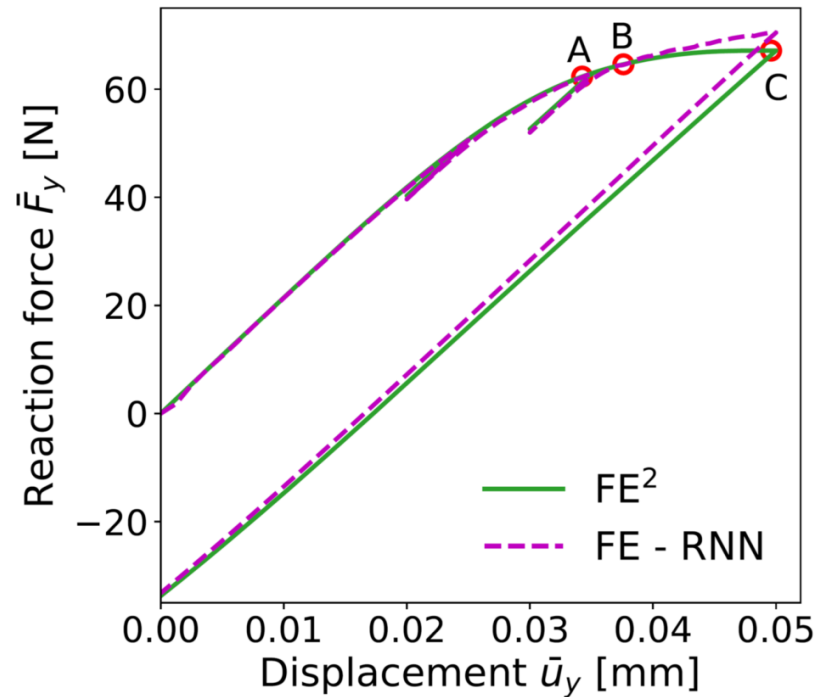

ANN as a mesoscale surrogate model

- Multiscale simulation

- Stress-strain distribution at point A
- Strain within the 10% training range

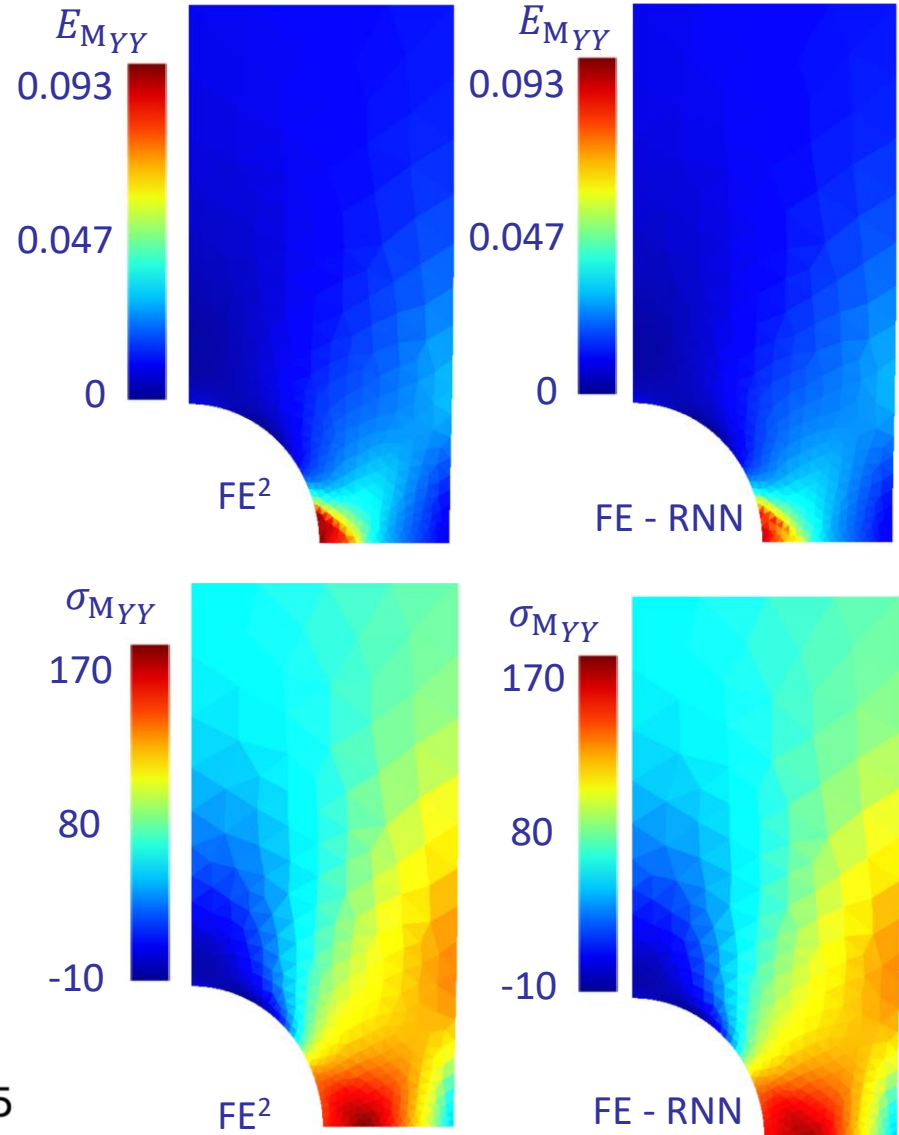
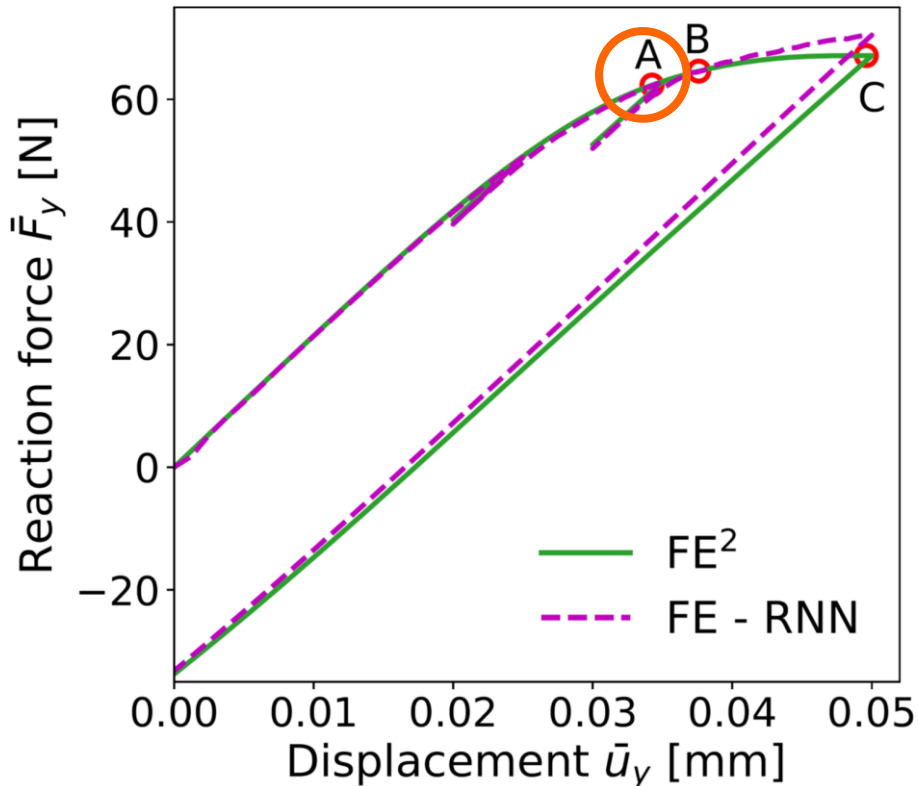

ANN as a mesoscale surrogate model

- Multiscale simulation

- Stress-strain distribution at point B
- Strain just at 10% training range

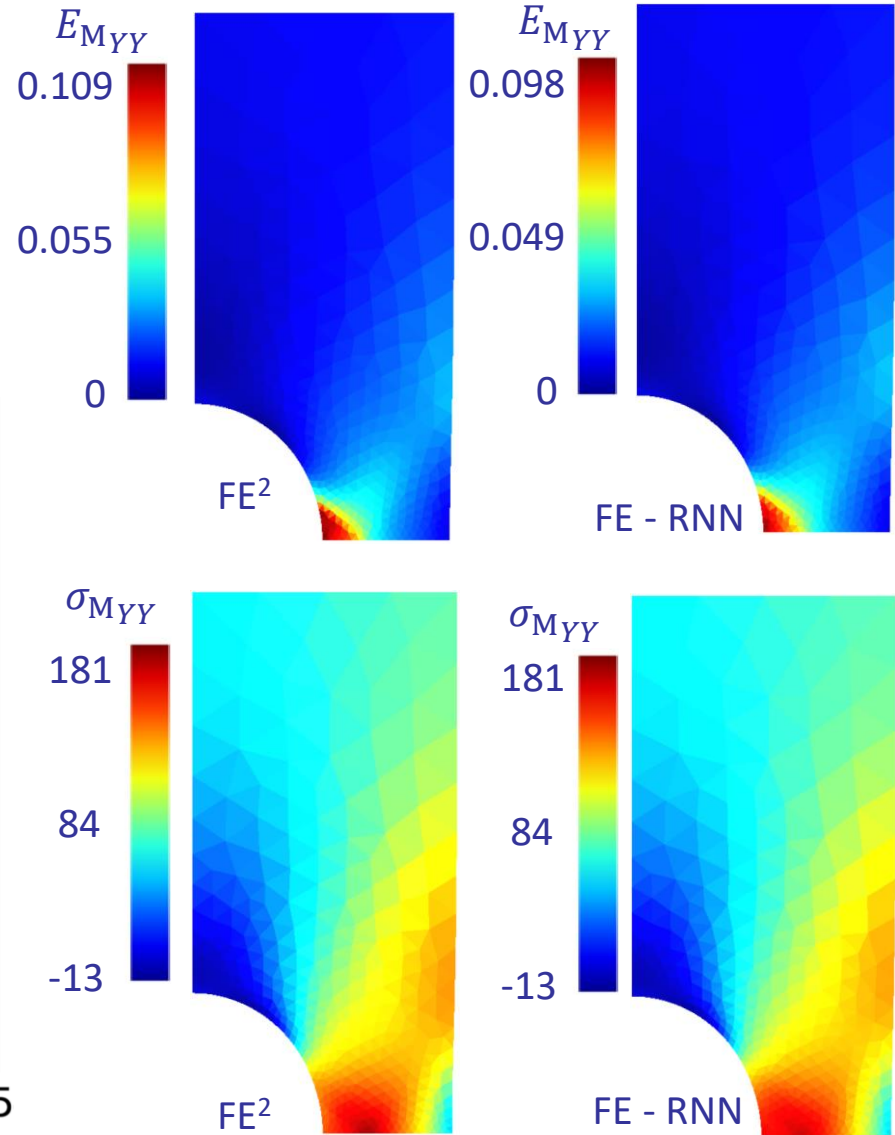
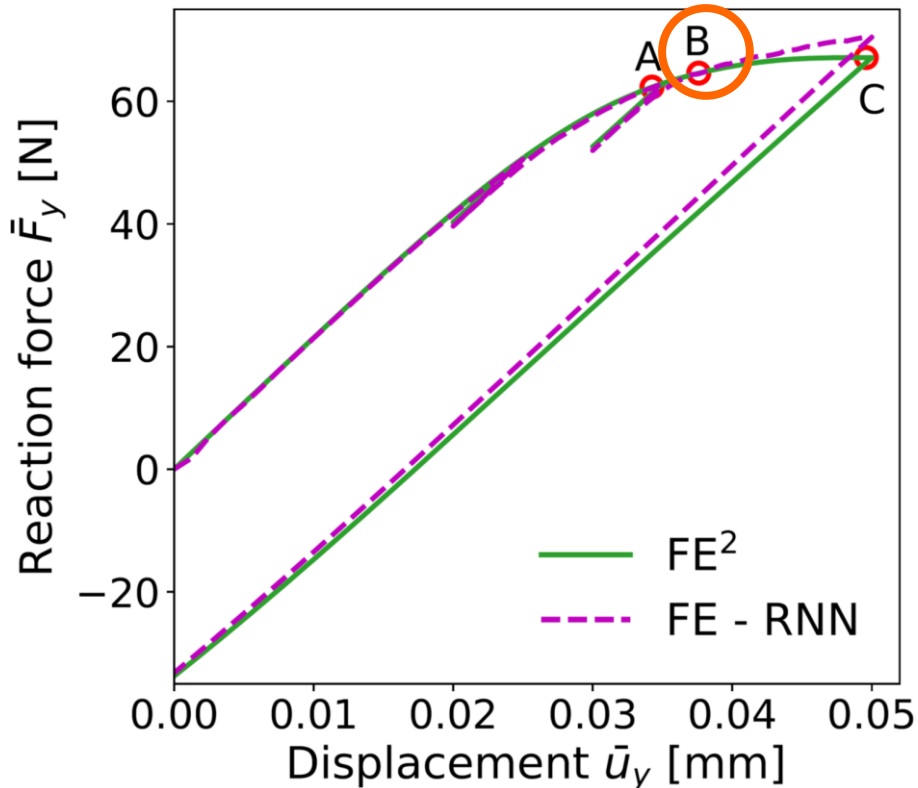

ANN as a mesoscale surrogate model

- Multiscale simulation

- Stress-strain distribution at point C
- Strain out of 10% training range

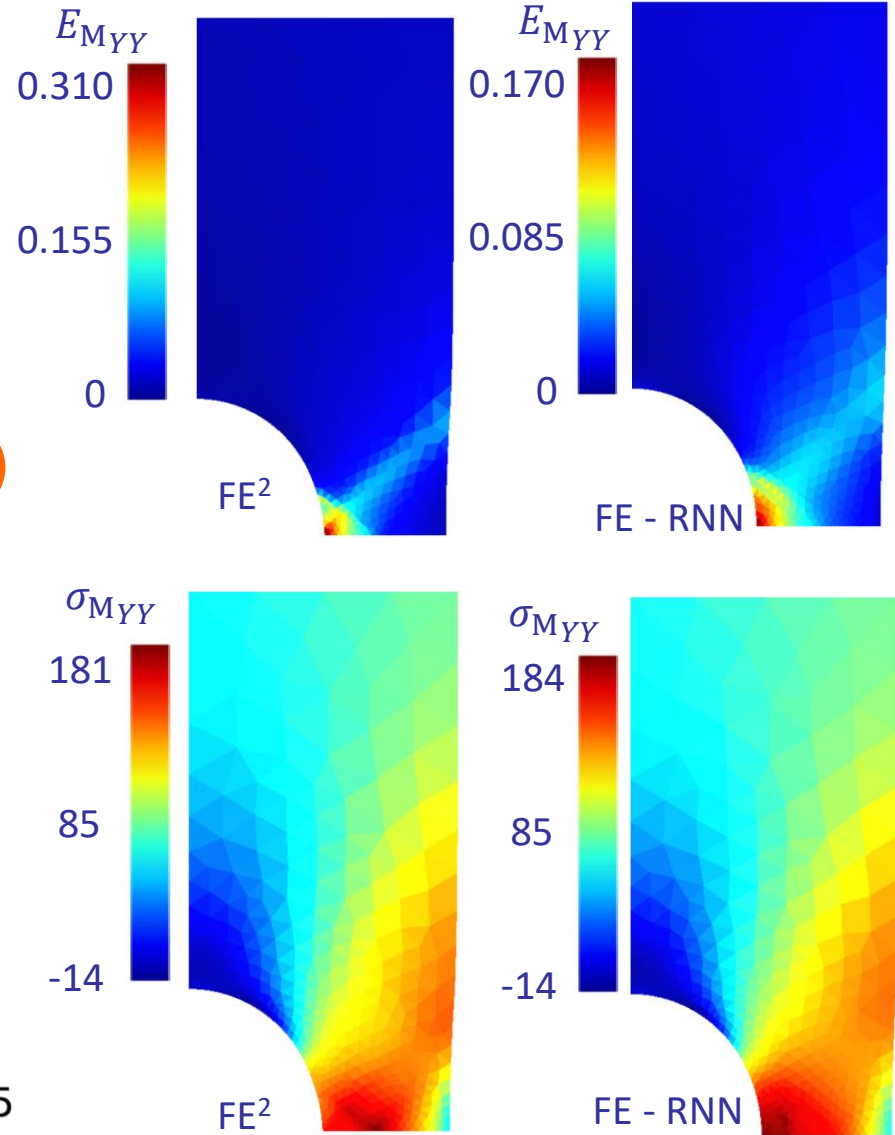
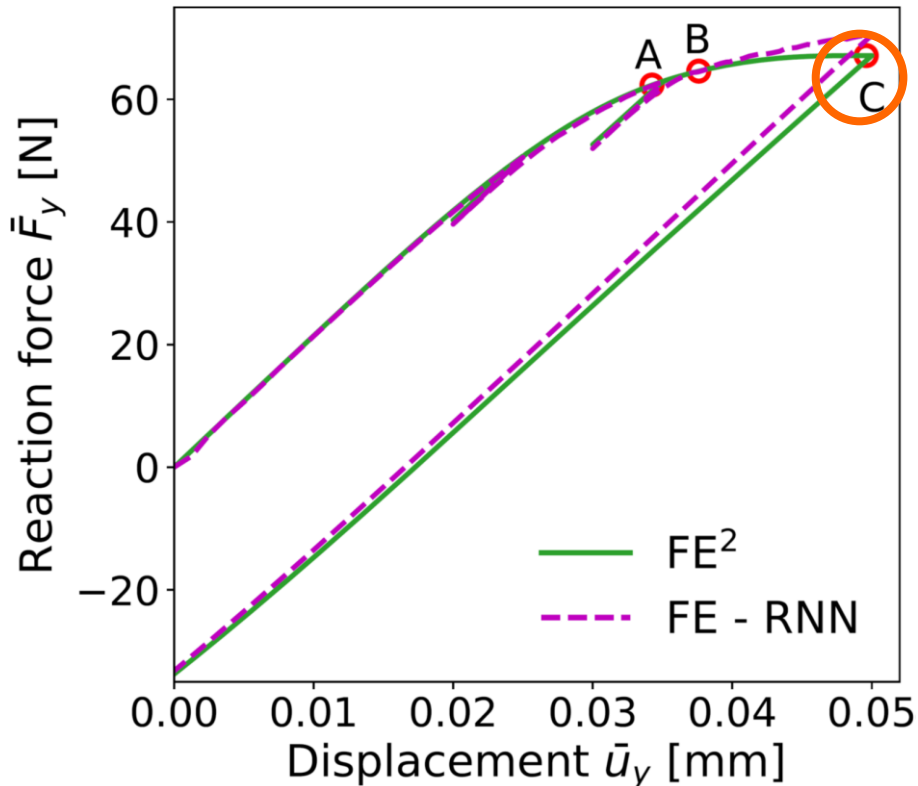

Conclusions

- More on
 - www.moammm.eu
 - L. Wu, V. D. Nguyen, N. G. Kilingar, and L. Noels. "A recurrent neural network-accelerated multi-scale model for elasto-plastic heterogeneous materials subjected to random cyclic and non-proportional loading paths." *Computer Methods in Applied Mechanics and Engineering* 369 (September 1, 2020): 113234, <http://dx.doi.org/10.1016/j.cma.2020.113234>

