



## Technical note

**Durability of mortars modified with metakaolin**Luc Courard\*, Anne Darimont, Marleen Schouterden, Fabrice Ferauche,  
Xavier Willem, Robert Degeimbre*Building Materials Research Unit, Department of Georesources, Geotechnologies and Building Materials, University of Liege, Liege, Belgium*

Received 23 January 2003; accepted 24 February 2003

**Abstract**

Results of an investigation to determine the effects of metakaolin additions on transport properties of mortars are reported. Comparisons are made to ordinary Portland cement (OPC) to determine the influence of addition and replacement percentage. Cement is replaced on a mass basis of 5–20% for metakaolin. A mixture with natural kaolin is also studied. The transport properties and chemical behaviors are analyzed by means of chloride diffusion tests and sulfate immersion. Observations after more than 100 days are used to prescribe mixtures that reduce the rate of chloride diffusion and sulfate degradation. For metakaolin, the optimum seems to be between 10% and 15% with regard to inhibition effect on chloride diffusion and sulfate attack.

© 2003 Elsevier Ltd. All rights reserved.

*Keywords:* Mortar; Metakaolin; Durability; Sulfate attack; Chloride**1. Introduction**

Most concretes and mortars contain ordinary Portland cement (OPC) (Fig. 1a) as a major component. The creation of a durable microstructure depends on water/cement ratio, mixture design and batching procedures, curing conditions, etc. OPC mixtures, however, can be susceptible to degradation:

- the porosity of cement paste and the interfacial transition zone (ITZ), allowing rapid transport of water and aggressive chemicals [1] and
- the production of high levels of calcium hydroxide during the hydration process ( $\pm 20\%$  in volume of hydrated OPC [2]). Calcium hydroxide is a slightly soluble and reactive material [1].

Many modern concrete mixtures are now modified with admixtures and additions that will enhance the microstructure as well as decrease the  $\text{Ca}(\text{OH})_2$  concentration by

consuming it through a pozzolanic reaction. The subsequent modification of the microstructure of cement composites improves durability and increases service-life properties.

Metakaolin is a manufactured material (Fig. 1b) that reacts rapidly with calcium hydroxide, via a pozzolanic reaction, to produce calcium silicate hydrates and calcium aluminosilicate hydrates [3]. The reaction products are less chemically reactive [4] and the ITZ is densified [5]. A less permeable cement composite material is produced, with a decrease in the volume of pores.

The aim of this work is to compare the durability of the mortars, with regard to sulfate attack and chloride diffusion, in the case of several replacement rates.

**2. Description of the products***2.1. Materials*

Two types of additions were used in order to analyze possible enhancement effect on durability properties: metakaolin (MTK) and natural kaolin (KAO).

Metakaolin is a manufactured product from selected kaolins, which are refined and calcined under particular conditions; it is a highly efficient pozzolan ( $\text{Al}_2\text{O}_3 \cdot (\text{SiO}_2)_2$ )

\* Corresponding author. Civil and Mechanical Engineering Institute (B 52/3), Chemin des Chevreuils 1, B-4000 Liege, Belgium. Tel.: +32-4-366-93-50; fax: +32-4-366-93-65.

E-mail address: [luc.courard@ulg.ac.be](mailto:luc.courard@ulg.ac.be) (L. Courard).

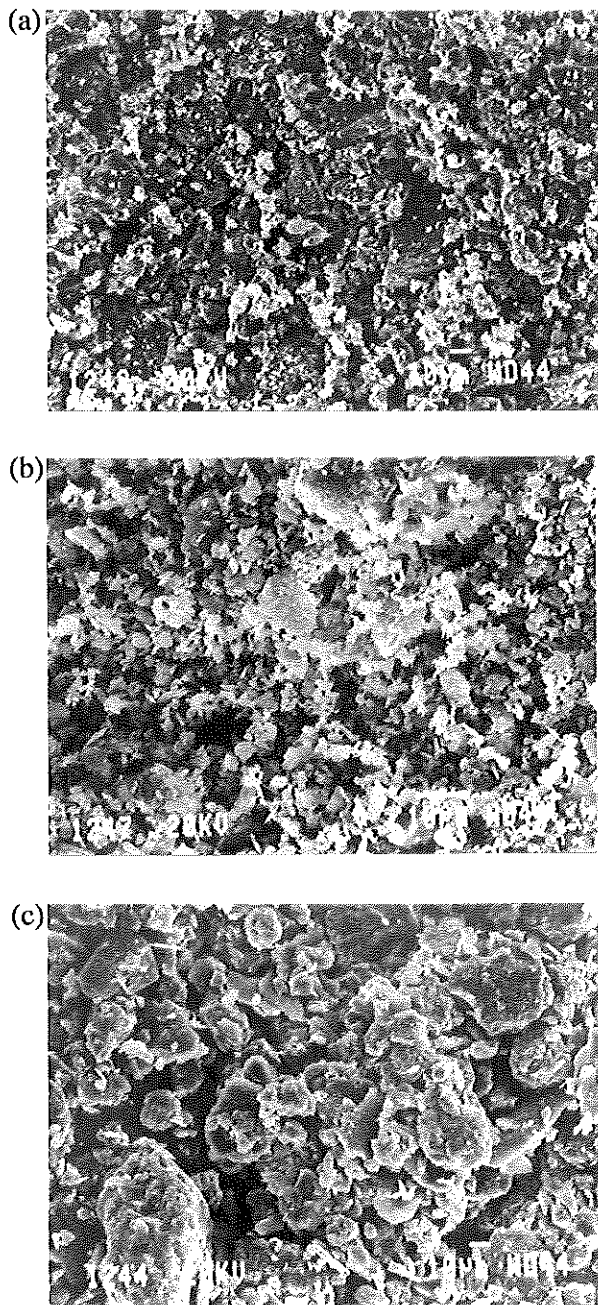

Fig. 1. Views at SEM of CEM I 42.5 (a), metakaolin (b) and kaolin (c) powders.

that reacts with calcium hydroxide  $\text{Ca}(\text{OH})_2$  produced during the hydration of OPC [6,7]. Additional gel, i.e., C-S-H gel, has a pore blocking effect and therefore alters the pore structure and strength [7]. Larbi [5] showed that calcium hydroxide can be virtually eliminated from the cement matrix by using sufficient adapted metakaolin concentrations. Kaolin is a natural clay (Fig. 1c) coming from a natural quarry in Malvoisin (Belgium). It has been used to point out the effect of industrial thermal treatment of metakaolin.

## 2.2. Specimen preparation

The specimens were a RILEM mortar (3 parts of sand, 1 part of cement and 0.5 part of water) in which cement is an OPC (CEM I 42.5). Ten separate series of composite specimens were prepared.

The first series of specimens was prepared from a mixture in which cement was replaced by metakaolin. Four different replacements, varying from 5% to 20%, on a cement mass basis, were mixed with the cement. One mix was made with 10% by mass of natural kaolin.

All sample preparations were processed in a similar manner according to European Standard EN 196-1 [8]. Water was first introduced in the mechanical blender. The dry mix solids (cement+addition) were then added to the water solution and mixed for 30 s at low speed; sand was added and mixed for 30 s. Then, the mixing proceeds in a sequence of three steps: 30 s mix at high speed, 90 s in rest and 60 s mix at high speed. The mortars were cast into  $4 \times 4 \times 16$  cm molds for 24 h and cured with plastic sheet. The hardened mortar was then demolded and kept at  $20 \pm 2$  °C and under water until 28 days. Molds of  $25 \times 25 \times 285$  mm are also used for shrinkage and sulfate resistance tests while specimens of 10 cm diameter and 15 cm high were prepared for chloride diffusion tests.

## 3. Description of the tests

Different tests were conducted in order to characterize the materials, to evaluate their physical and mechanical performances and to evaluate their durability with regard to chloride and sulfate ingress.

### 3.1. Tests on the components

**Granulometry:** The granulometry was evaluated by means of laser granulometer.

**Specific surface:** Specific surface was determined according to BET method.

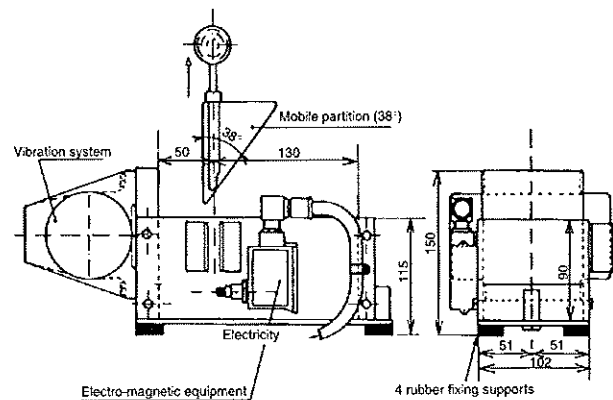
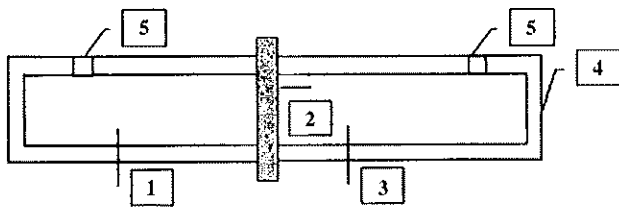

Fig. 2. Description of "Maniabilimètre à mortiers" (NF P18-452).



- 1 = saturated Ca(OH)<sub>2</sub> solution + 1 M NaCl
- 2 = specimen (paste or mortar)
- 3 = saturated Ca(OH)<sub>2</sub> solution
- 4 = container (PMMA)
- 5 = opening for collection of solution samples and fulfilling of cells

Fig. 3. Experimental setup of diffusion cells.

3.2. Tests on fresh mortars

Consistency: The consistency was evaluated by measuring the flow rate of mortars according to the NBN B14-207 (Belgian standard) [9].

A measurement of the workability was performed with “Maniabilimètre à mortiers” described in French Standard NF P18-452 [10]: It is the measure of the time necessary for a defined quantity of mortar to cross a reference line while flowing under a specified vibration (Fig. 2).

3.3. Tests on hardened mortars

Shrinkage: The shrinkage measurements began 1 day after specimen preparation. Three specimens of 25 × 25 × 285 mm are used for the tests. Strain is continuously measured and the specimens are stored in dry conditions (20 ± 2 °C and 50 ± 5% RH) according to NBN B14-217 [11].

Water absorption: The water absorption tests on the specimens are conducted after 28 days standard curing. First, the specimen is heated to 105 °C until dry (less than 0.1% mass change in 24 h). After weighing, specimens are immersed in a container of water at 20 ± 2 °C. Each specimen is removed from water, wiped off with a damp cloth and weighed (wet mass). The immersion continues

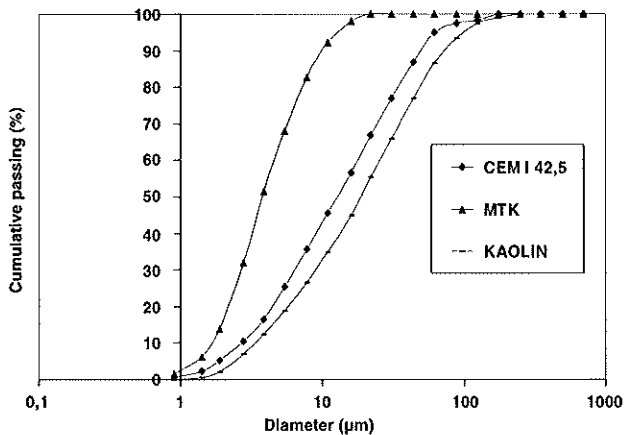

Fig. 4. Laser granulometry measurement of cement CEM I 42.5, metakaolin and kaolin.

Table I  
Absolute specific mass and specific surface of cement CEM I 42.5, metakaolin and kaolin

	MVA (g/cm <sup>3</sup> )	S <sub>BET</sub> (m <sup>2</sup> /g)
CEM I 42.5	3.12	0.86
Metakaolin	2.54	8.9
Kaolin	2.71	3.4

until there is no variation mass greater than 0.1% after 24 h (according to NBN B15-215 [12]).

Water absorption by capillary: Samples of 28 day curing are dried in an oven at 40 ± 5 °C until constant weight (minimum 7 days). Samples are then stored in water on their cross section (4 × 4 cm) with a constant water height of 5 mm. Mass variation and capillary suction heights are registered until 72 or 144 h. The test procedure is in accordance with NBN B14-201 [13].

Bending strength and compression: Three prismatic specimens with dimensions of 40 × 40 mm in cross section and 160 mm in length are made by molding and standard curing. Bending strength and compression are measured after 3, 7, 14 and 28 days (according to NBN B12-208 [14]).

3.4. Durability tests

The effectiveness of admixtures was evaluated by means of two durability tests: (1) chloride diffusion and (2) sulfate attack.

Rates of diffusion of Cl<sup>-</sup> and Na<sup>+</sup> ions into cement mortars are monitored using two-compartment diffusion cells

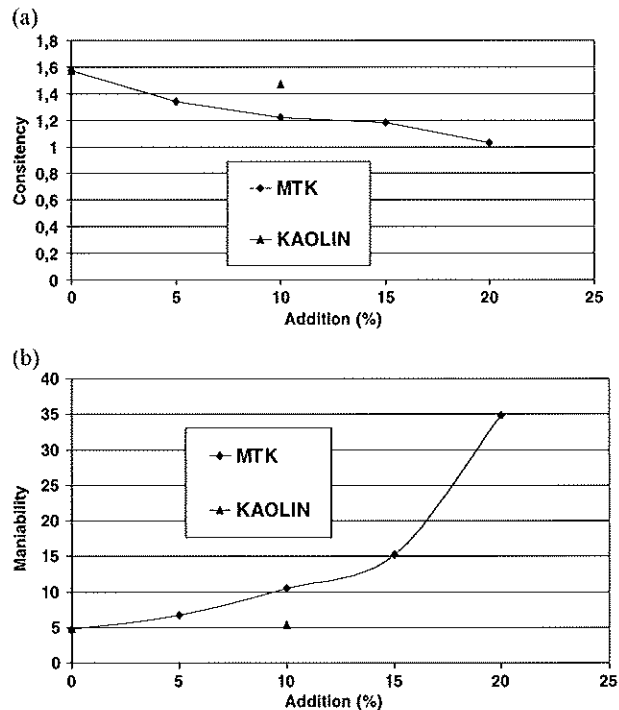

Fig. 5. Flow test (a) and workability (b) for mortars with cement CEM I 42.5, metakaolin and kaolin.

Table 2  
Bending strength and compression strength of mortars

Materials	Bending strength (MPa)				Compression strength (MPa)			
	3	7	14	28	3	7	14	28
100% Cement CEM I 42.5	7.17	7.81	8.79	9.12	34.5	47.1	49.7	57
5% Metakaolin	6.44	7.81	9.24	9.51	34.4	46.3	57.5	65.1
10% Metakaolin	6.59	8.2	9.14	9.47	32.4	48.6	58.8	70.2
15% Metakaolin	6.26	7.62	8.75	9.45	31.7	47.9	63.8	71.2
20% Metakaolin	5.49	7.69	8.81	9.14	27.4	49.4	61.5	68.4
10% Kaolin	–	–	–	8.32	–	–	–	48.1

(Fig. 3). Mortar blocks 7 mm thick are sawed from 8 cm diameter specimens and stored in  $\text{Ca}(\text{OH})_2$  saturated solution. Prior to the test, each specimen is polished with 600-grade emery paper, rinsed with deionized water and surface dried with a tissue before being fitted into the diffusion cell.

After fitting with epoxy resin and sealing with silicon paste, the cells are filled at one side with  $\text{Ca}(\text{OH})_2$  solution and at the other side with 1 M NaCl in saturated  $\text{Ca}(\text{OH})_2$  solution.

At periodic intervals, chloride concentration is determined by titration from a 20 cm<sup>3</sup> sample of the solution.

Determination of the resistance of mortars to attack by sulfate is performed according to standard prEN 196-x. The method involves the determination of the changes in length of prismatic specimens when stored in a standard sulfate solution. At the age of 28 days, the specimens are measured for length and placed in the sulfate solution having a concentration of  $16.0 \pm 0.5$  g/l  $\text{SO}_4^{2-}$  and prepared by adding reagent-grade sodium sulfate ( $\text{Na}_2\text{SO}_4$ ) to water. Corresponding control specimens are placed in limewater. Changes in length of the specimens are measured after storage periods of 4, 8, 12, 16, 20, 28, 40 and 52 weeks at  $23 \pm 2$  °C.

## 4. Results and discussion

### 4.1. Tests on the components

The laser granulometry revealed that kaolin (Fig. 1c) is lightly coarser than cement while metakaolin (Fig. 1b) is clearly finer than cement (92% and 45% finer than 10  $\mu\text{m}$  for metakaolin and cement, respectively) (Fig. 4). The absolute specific mass (density of the solid skeleton) gave the classical values as well as specific surface (Table 1).

### 4.2. Tests on fresh mortars

Due to the fineness of the grains, consistency of mixes with metakaolin greatly decreases in comparison with the cement mortar reference. As seen in Fig. 5, the use of 5% metakaolin induces an increase of 14.6% in the consistency while it is only lightly detectable for kaolin. At 15% replacement, however, the impact on consistency appears to be more dramatic: decrease of consistency of 25% for metakaolin. The addition of 20% metakaolin induces an increase of 34% of consistency. Workability is a word that represents the easiness of manipulation, pumpability or shearing of a paste.

### 4.3. Tests on hardened mortars

The evolution of mechanical resistance of mortars with time and with addition percentage is given in Table 2.

Many remarks can be formulated about these results (see Table 2 and Fig. 6):

- For bending strength, replacement of cement by metakaolin induces a decrease in the mechanical strength during the first days but an equal resistance after 28 days (Fig. 6).

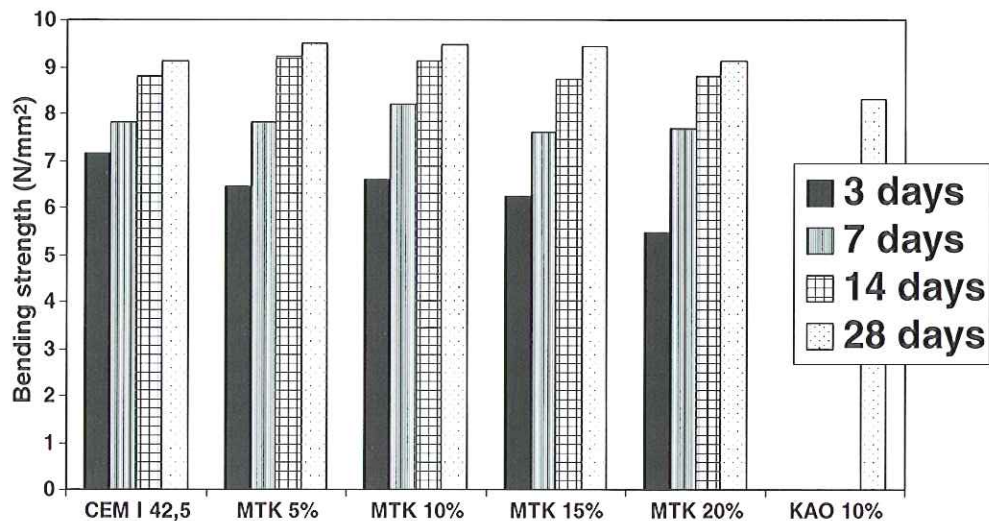

Fig. 6. Bending strength of mortars with cement CEM I 42.5, metakaolin and kaolin.

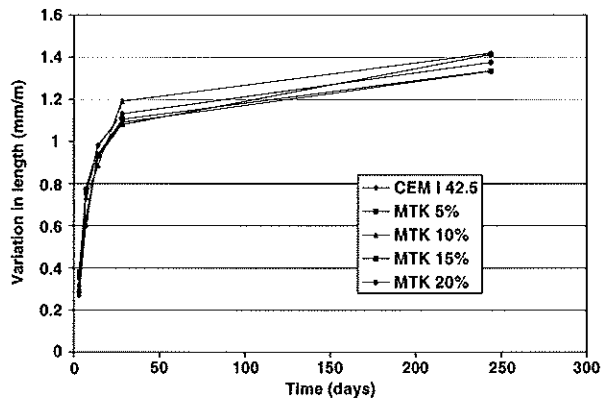

Fig. 7. Evolution of shrinkage for mortars with cement CEM I 42.5 and metakaolin (MTK).

- The cement mix is characterized by a very quick development in mechanical strength because, at 3 days, 79% of the final resistance at 28 days is already achieved.
- The percentage of metakaolin is not a statistically discriminate parameter. More than 15% replacement of cement with metakaolin, however, seems to induce a decrease of bending and compression strength (14%, 4% and 4% in compression at 3, 14 and 28 days, respectively, between 15% and 20%).
- The use of kaolin induces a small decrease of mechanical performances but no more than 9% in flexion and 15.5% in compression at 28 days for 10% replacement.

Shrinkage yield gives also a lot of information about the long-term behavior of mortar. Metakaolin addition does not affect the amplitude of shrinkage of the mixes for different proportions of replacement (Fig. 7). Kaolin has no effect on shrinkage.

Water absorption was performed on samples after 28 days and 14 months hydration (Table 3). Additions result in increase of water absorption measured by total immersion. The samples were stored in laboratory atmosphere (20 °C and 60% RH) for 14 months. The measurement of water absorption after 14 months illustrates the effect of cement paste carbonation as seen in Tables 3 and 4: The decrease of water absorption is 4.1% for cement mortar.

Table 3  
Water absorption for mortars with cement CEM I 42.5, metakaolin and kaolin after 28 days and 14 months

Material	Water absorption (percentage in mass)		Decrease ratio
	After 28 days	After 14 months	
CEM I 42.5	8.16	7.82	4.1
5% Metakaolin	8.39	8.04	4.1
10% Metakaolin	8.78	8.44	3.9
15% Metakaolin	9.71	8.77	9.7
20% Metakaolin	9.70	8.97	7.5
10% Kaolin	9.51	7.90	16.9

Table 4

Water capillary action for mortars with cement CEM I 42.5, metakaolin and kaolin after 28 days and 14 months

Material	Absorption by capillarity after 28 days (g/m <sup>2</sup> )				
	3 h	6 h	29 h	72 h	–
CEM I 42.5	0.13	0.2	0.3	0.39	–
5% Metakaolin	0.11	0.16	0.29	0.38	–
10% Metakaolin	0.14	0.19	0.31	0.39	–
15% Metakaolin	0.14	0.2	0.3	0.4	–
20% Metakaolin	0.13	0.18	0.28	0.34	–
10% Kaolin	0.15	0.21	0.33	0.42	–

Material	Absorption by capillarity after 14 months (g/m <sup>2</sup> )				
	3 h	6 h	29 h	72 h	144 h
CEM I 42.5	0.23	0.32	0.76	0.88	0.92
5% Metakaolin	0.17	0.23	0.64	0.90	1.07
10% Metakaolin	0.18	0.24	0.60	0.80	0.98
15% Metakaolin	0.17	0.23	0.53	0.75	0.95
20% Metakaolin	0.16	0.21	0.48	0.70	0.91
10% Kaolin	0.23	0.31	0.77	1.10	1.36

The decrease in water absorption on metakaolin-modified mortars, however, should be lesser for cement mortar. This is not the case for 15% and 20% replacement; it is larger. This can be due to a lack of homogeneity of the mortar caused by an inadequate blending; this can be also due to the fact that the pozzolanic effect has had insufficient time to proceed because tests were initiated after only 28 days of hydration.

Ingress of water has been also studied by water capillary absorption (Table 4). Measurements of mass variation after 72 h show for metakaolin a relatively constant value of mass variation in comparison with cement mix but a light decrease for 20% replacement ratio. This is probably due to the lower granulometry of metakaolin particles, which are able to complete the granular skeleton of fine particles. The effect does not appear clearly positive. Maybe a modification of the dimension of the pore is produced by pozzolanic reaction but the quantity of the total water that is absorbed still remains the same. The effect of pore diameter modi-

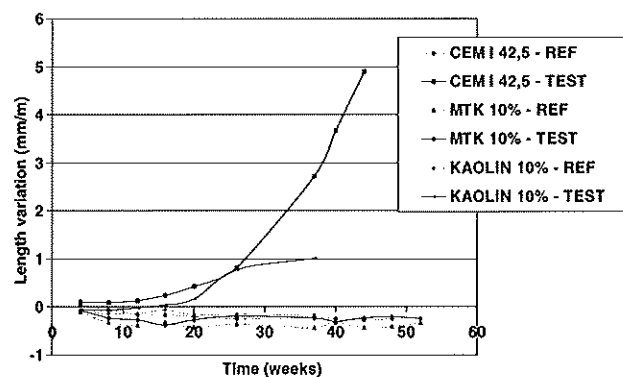

Fig. 8. Length variation of mortars with cement CEM I 42.5, metakaolin (10%) and kaolin (10%) in sulfate solution and in reference solution.

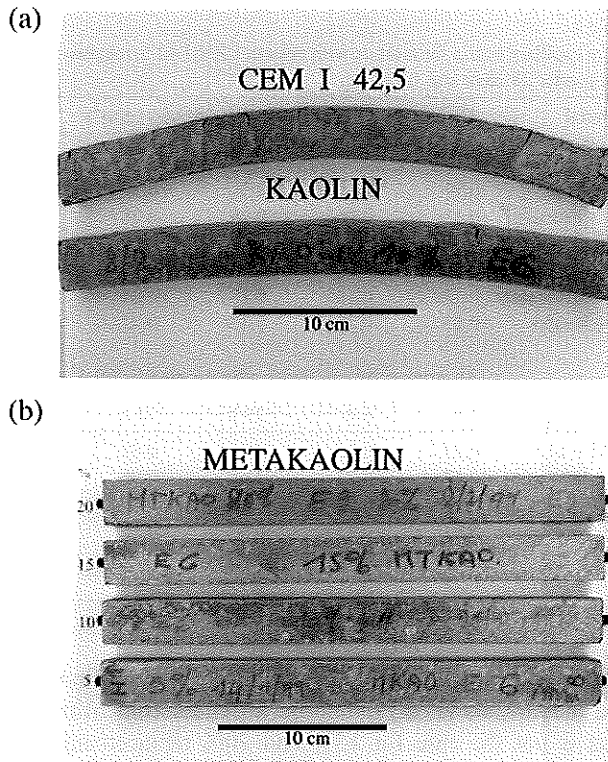

Fig. 9. Specimen of mortars with cement CEM I 42.5 (a), metakaolin (b) and kaolin (a) after 44 or 52 weeks in sulfate solution.

fication could be confirmed by registering the variation in mass in the early stage of the test [15].

4.4. Durability tests

The two durability tests are ion transport (diffusion) and sulfate reactivity characterized by dimensional variation.

4.4.1. Resistance to sulfates

The dimensional variations of specimens were measured for 52 weeks in Ca(OH)<sub>2</sub> and SO<sub>4</sub><sup>2-</sup> solutions (Fig. 8). Fig. 9 presents the shape of different specimens after 44 and 52 weeks storage in sulfate solution.

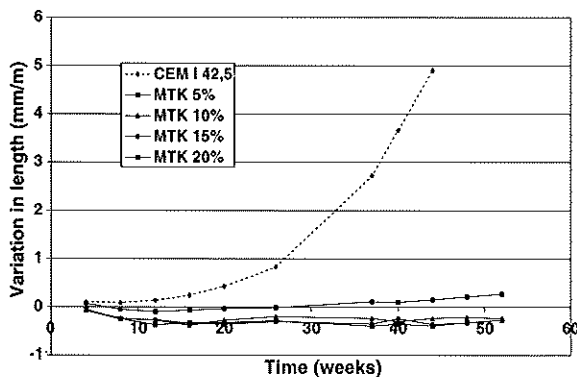

Fig. 10. Variation in length of mortars with cement and metakaolin in sulfate solution.

Table 5

Chloride diffusion rates for mortars with cement CEM I 42.5, metakaolin and kaolin

Material	Breakthrough time (days)	Apparent diffusion coefficient (m <sup>2</sup> /s)
CEM I 42.5	13	1.29 × 10 <sup>-12</sup>
5% Metakaolin	45	4.71 × 10 <sup>-12</sup>
10% Metakaolin	82	3.31 × 10 <sup>-12</sup>
15% Metakaolin	203	1.23 × 10 <sup>-12</sup>
20% Metakaolin	not yet after 1 year	—
10% Kaolin	4	1.81 × 10 <sup>-12</sup>

As seen in Fig. 8, OPC mortar exhibits expansion after only a few days. Variation in length after only 84 days is 3.7%. If we compare metakaolin-modified mortar behaviors in reference and sulfate solutions, we can observe an inhibition of sulfate attack, especially for more than 10% replacement of cement part (Fig. 10). Metakaolin, by consuming Ca(OH)<sub>2</sub>, has a large positive effect on mortar durability in the sulfate environment.

4.4.2. Chloride diffusion

The evolution of chloride diffusion has been measured for 314 days for cement, metakaolin and kaolin (Table 5). The occurrence time (breakthrough time) was calculated from the intercept of the concentration versus time date (see Fig. 11).

Transport through OPC mortar specimens is observed after only 13 days, with an apparent diffusion coefficient of 1.29 × 10<sup>-12</sup> m<sup>2</sup>/s.

The same test results for the different metakaolin replacements are shown in Table 5. The occurrence time as well as the diffusion coefficient were calculated; occurrence time (breakthrough time) represents the time necessary for the initiation of Cl<sup>-</sup> ion transfer through the sample. It gives, consequently, a view of the porous skeleton. From Fig. 11, the observation of curves clearly points out the increase of occurrence time with metakaolin content. The best results are obtained for a metakaolin content of 20% because after about 1 year test no diffusion is observed. An increase from 10% to 15% metakaolin content seems to induce an increase

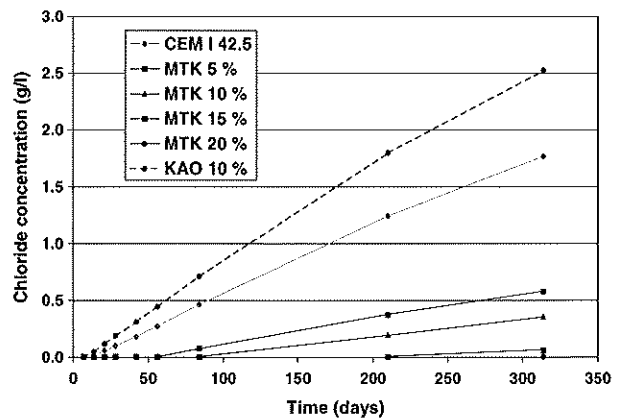

Fig. 11. Chloride diffusion rates for mortars with CEM I 42.5, metakaolin and kaolin.

of 150% of occurrence time and a decrease of 170% for diffusion coefficient. We observed almost no dispersion in the results for the three tests realized for each composition. Kaolin (Fig. 11) has no effect and seems on the contrary to accelerate the phenomenon of diffusion in comparison with the reference mix.

## 5. Conclusions

The results we obtained are related to the behavior of mortar. Any extension of conclusions should be regarded with prudence with regard to the influence of the ITZ zone between cement paste and aggregate.

However, they give interesting information on what can be expected by the use of the two main types of mineral admixtures we analyzed:

- For metakaolin admixtures, the optimum seems to be between 10% and 15% regarding the low decrease of workability, the best mechanical performances and the inhibition effect on the chloride diffusion and sulfate attack. The positive effect is clearly pointed out through the two last investigations where, for 20% metakaolin, no diffusion is observed after 1 year test.
- For kaolin, no effect or negative effect is usually obtained and measured. This is probably due to the mineralogical characteristics of the material and to the lack of thermal treatment of the aluminosilicates in the base material.

Chloride diffusion tests must be analyzed in terms of apparent diffusion coefficient but also of the breakthrough time. This last value is useful for a complete discrimination in the behavior of the different mortars: An increase of metakaolin concentration induces an increase of the breakthrough time, while no major differences are observed on diffusion coefficient.

To confirm these results, new investigations should be performed and include the observations of the microstructure and the quantification of the porosity of the hardened mortars. These observations should give us an idea of the effectiveness of these admixtures regarding dispersion and solids precipitation. Tests on metakaolin-modified mortars will also be performed in order to test the performances of mortars after a time sufficient for pozzolanic effect manifestation.

## Acknowledgements

This project was supported by the Walloon Ministry for Technology and Research through the Enhancement of Concrete Design with Crushed Sands research project (convention NR 98/13808). The assistance of Mrs. M. Denotte is gratefully acknowledged for the preparation of the specimens.

## References

- [1] P.K. Mehta, J.M. Monteiro, Effect of aggregate, cement and mineral admixtures on the microstructure of the transition zone, in: S. Mindess, P.S. Shah (Eds.), *Bonding in Cementitious Composites*, Materials Research Society, Pittsburgh, 1987, pp. 65–75.
- [2] R. Gagné, *Cours de Durabilité et Réparations des Bétons (GCI-714), Chapitre 2: La Durabilité des bétons*. Université de Sherbrooke, Canada, 2002, p. 32, [www.usherb.ca](http://www.usherb.ca).
- [3] K.O. Kjellsen, B. Lagerblad, Influence of natural minerals in the filler fraction on hydration and properties of mortars, Swedish Cement and Concrete Research Institute, CBI Report 3:95, 1995, 41 pp.
- [4] R.A. Silverlock, Strengthening applications, *Concr. Int. J.* (1999) 61–63.
- [5] J.A. Larbi, The cement paste–aggregate interfacial zone in concrete, PhD thesis, Delft University, 1991.
- [6] S. Wild, J.M. Khatib, A. Jones, Relative strength, pozzolanic activity and cement hydration in superplasticised metakaolin concrete, *Cem. Concr. Res.* 26 (10) (1996) 1537–1544.
- [7] J.M. Khatib, S. Wild, Pore size distribution of metakaolin paste, *Cem. Concr. Res.* 26 (10) (1996) 1545–1553.
- [8] EN 196-1, Methods of testing cement: Part 1. Determination of strength, European Committee for Standardization, Brussels, 1995.
- [9] NBN B14-207, Essais des mortiers. Consistance—étalement à la table à secousses, Belgian Institute for Standardization, Brussels, 1969.
- [10] NF P18-452, Bétons. Mesures du temps d'écoulement des bétons et des mortiers au maniabilimètre, Association Française de Normalisation, Paris-la-Défense, 1988.
- [11] NBN B14-217, Essais des mortiers. Retrait et gonflement, Belgian Institute for Standardization, Brussels, 1970.
- [12] NBN B15-215, Tests on concrete: Water absorption by immersion, Belgian Institute for Standardization, Brussels, 1969.
- [13] NBN B14-201, Tests on mortars: Water absorption by capillarity, Belgian Institute for Standardization, Brussels, 1973.
- [14] NBN B12-208, Ciments. Essais de flexion et compression, Belgian Institute for Standardization, Brussels, 1969.
- [15] L. Courard, R. Degeimbre, A capillary action test for the investigation of adhesion in repair technology, *Canadian Journal of Civil Engineering*, Vancouver, Canada, accepted for publication.

