

COP21 and Electrical Systems

(in twenty minutes)

Prof. Damien ERNST



Greenhouse gas emissions, by source sector, EU-28, 1990 and 2013 (% of total):

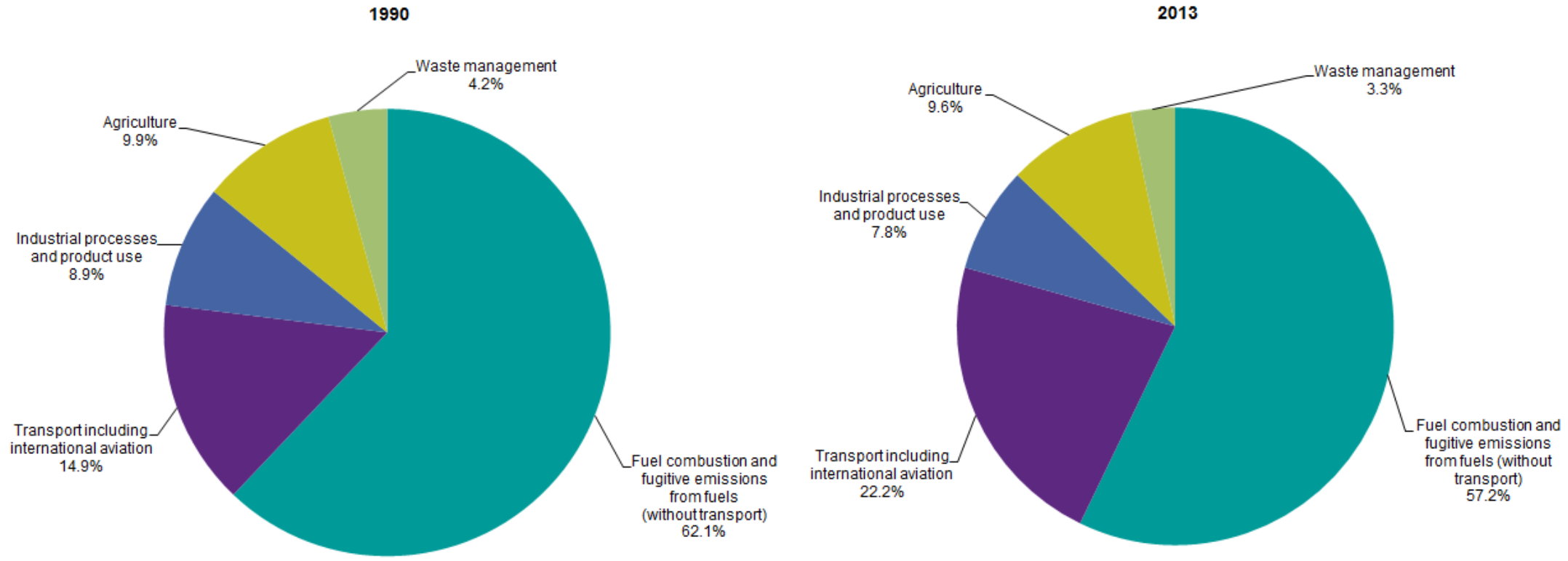

COP21: Ambitious cuts in greenhouse gas emissions => Necessarily implies (virtually) stopping burning fossil fuels.

Three credible alternatives?

Nuclear power. Costs in 2016: 60€/MWh-120€/MWh. Depends on the technology used and the labour costs.

Solar energy. Cost in 2016: 40 €/MWh-130€/MWh. Strong dependance on solar irradiance. Costs dropping **rapidly**.

Wind energy. Cost in 2016: 40 €/MWh-140€/MWh. On-shore energy generation is less expensive than off-shore generation, but there are a limited number of suitable places for installing wind turbines on land. Costs are dropping.

Credible perhaps, challenging certainly

Let us assume that the average final energy consumption in the EU-28 is around 150 kWh/person/day. There are around 500 million people living in the EU-28.
Yearly energy consumption EU-28 : $150 \times 365 \times 500 \times 10^6 = \mathbf{27,375 \text{ TWh}}$ (1 T = 10^{12})

Yearly energy consumption Belgium : $150 \times 365 \times 11 \times 10^6 \simeq \mathbf{600 \text{ TWh}}$. This is equivalent to the yearly energy generated by a source having a constant power output of 68,493 MW.

Official statistics for final energy consumption: 44.028 MTOe = $\mathbf{512 \text{ TWh}}$. Actual final energy consumption greater than in official statistics that do not take into account energy embodied into the stuff we import from abroad.

Electricity consumption in Belgium in 2013: $\mathbf{83 \text{ TWh}}$, that is around $\mathbf{8 \text{ times less}}$ than the total energy consumption of the country => It is naive to think that the Belgian electrical grid could easily be adapted to transport 600 TWh of electrical energy every year, or even 150 TWh every year.

How to generate 600 TWh of energy every year ?

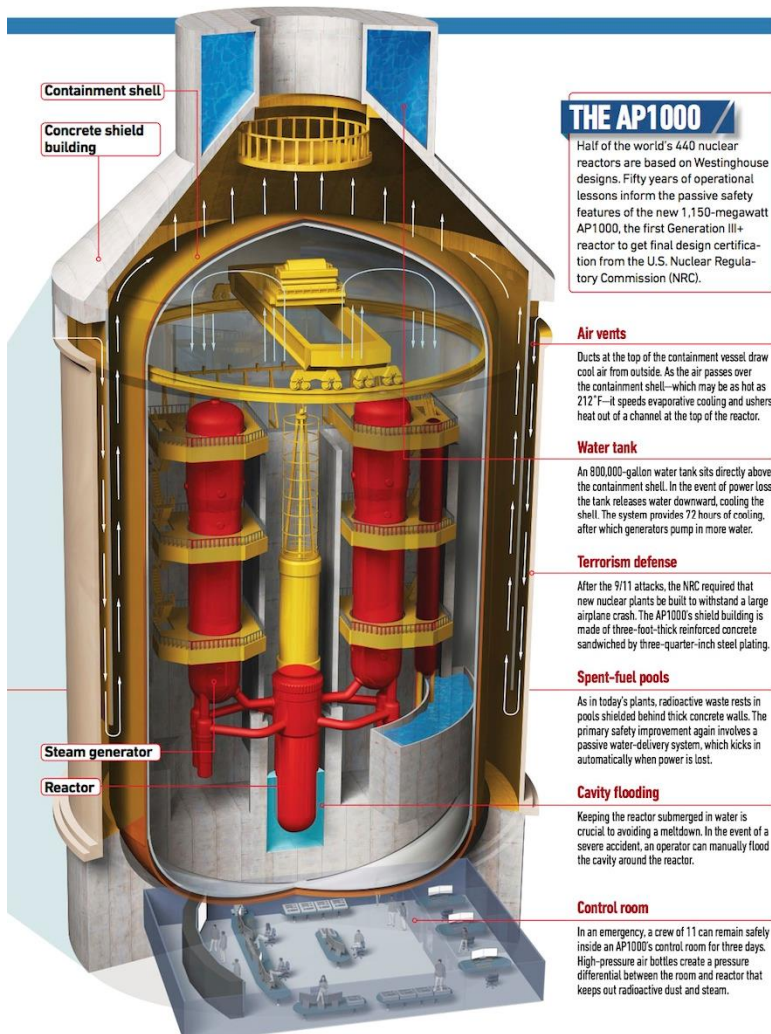

69 AP1000 nuclear reactors (designed and sold by Westinghouse Electric). That corresponds to 76103 MW of installed nuclear power capacity, or 12.7 times the nuclear power capacity available in Belgium in 2016.

Data: Peak power of an AP1000 = 1100 MW, load factor = 90%, installed nuclear power in Belgium in 2016 = 6000 MW.

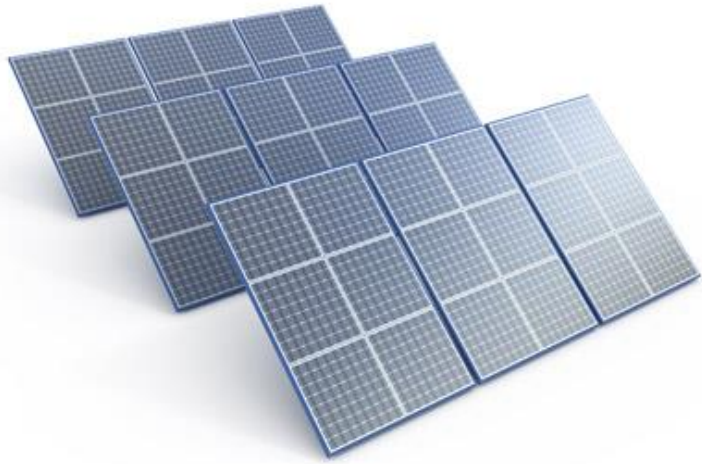

3424 km² of PV panels. This corresponds to an installed capacity of 685 GW (1 GW = 10⁹ W), or around 200 times the installed PV capacity in Belgium in 2016.

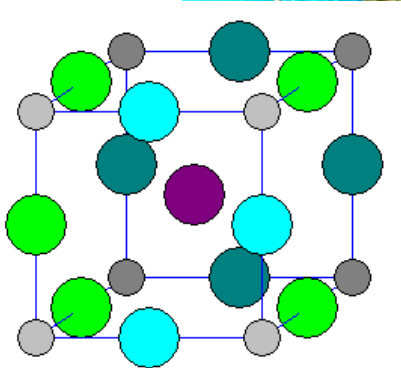
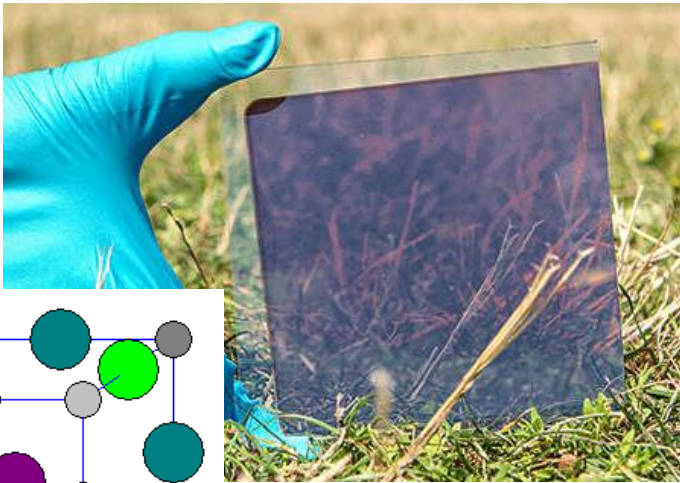

Perovskite CaTiO₃

Data: Solar irradiance = 100 W/m². Efficiency of PV panels 20%. Load factor of PV panels: 10%. Installed PV capacity in Belgium in 2016: around 3 GW.



30220 Enercon-126 wind turbines = 229,071 MW of installed wind capacity, around 100 times more than the wind capacity currently operational in Belgium in 2016. This would correspond to wind farms covering 17,180 km² of land.

Data: Maximum power of an Enercon-126 wind turbine = 7.58 MW, load factor= 30%. A wind farm can collect around 4 W/m² in Belgium. Wind capacity in Belgium in 2016: around 2000 MW.

What about storage needs?

Power Produced = Power Consumed + Power Stored + Power Wasted

Storage needs for daily fluctuations : We compute the storage needs caused by daily fluctuations of PV installations in Belgium by assuming that all the energy (600 TWh/year or 150 kWh/person/day) is generated by PV panels. We make the following assumptions: (i) the load will be constant (ii) PV sources generate a constant power from 7 am till 7 pm and no power outside those hours. (iii) Efficiency of 1 for storage.

Storage capacity needed: $600 \div 365 \div 2 = 0.82$ TWh = 820,000,000 kWh



The Tesla Powerwall: capacity of 7 kWh and price tag of around €3000 => 117,142,857 Powerwalls would be needed. It would cost **€351 billion**. With rapid progresses in battery technology, this amount is likely to drop to **less than €100 billion** by 2020.

Note that with a price tag of around €1/Wp for the PV panels, installing the PV capacity necessary for producing 600 TWh of energy per year in Belgium would cost **€685 billion**.

Note: GDP Belgium in 2015 : **€400 billion**



Average solar irradiance figures (in kWh/day/m²) in Belgium



Jan	Feb	Mar	Apr	May	Jun	Jul	Aug	Sep	Oct	Nov	Dec
0.9	1.5	2.5	3.7	4.8	5.0	4.9	4.3	2.9	1.8	1.0	0.7

Storage needs for daily fluctuations: Solar irradiance during the six sunniest months of the year (April - September) is three times higher than during the other months of the year (October-March). To smooth out the seasonal fluctuations of PV energy, a quarter of the 600 TWh would have to be stored during the sunny period, that's 150 TWh. This would cost **thousands of billions** of euros for storing this energy with batteries.

Other solutions: (i) Oversize the PV installations and throw power away during the sunny period (ii) Transform electricity into hydrogen that has a storage cost of around €2/kWh (and probably around €100/kWh for batteries in 2020). **There is the possibility of using this hydrogen directly as a substitute for carbon-based fuels.**

Producing huge amounts of renewable energy: challenges ahead for distribution networks



Local storage, self-consumption, smart management of the system and investments in cables and lines: required for **integrating** significant amount of renewable energy into distribution networks.

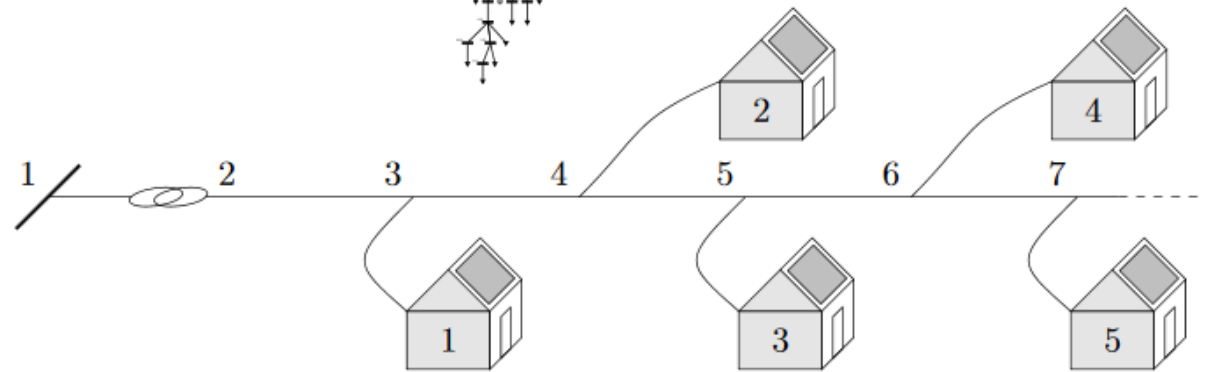

Microgrids: a key part of the solution

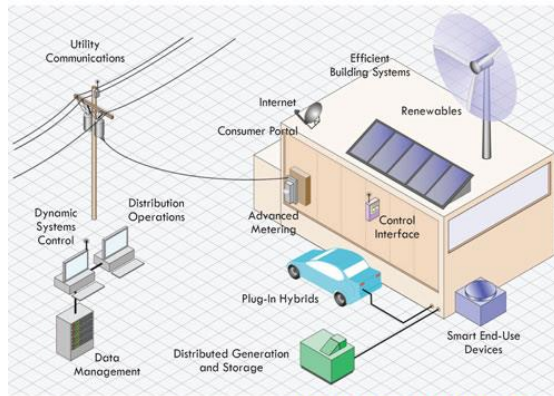

CAPABILITIES OF A SMART MICROGRID

This revolutionary system design meets U.S. energy challenges and maximizes consumer and business value.

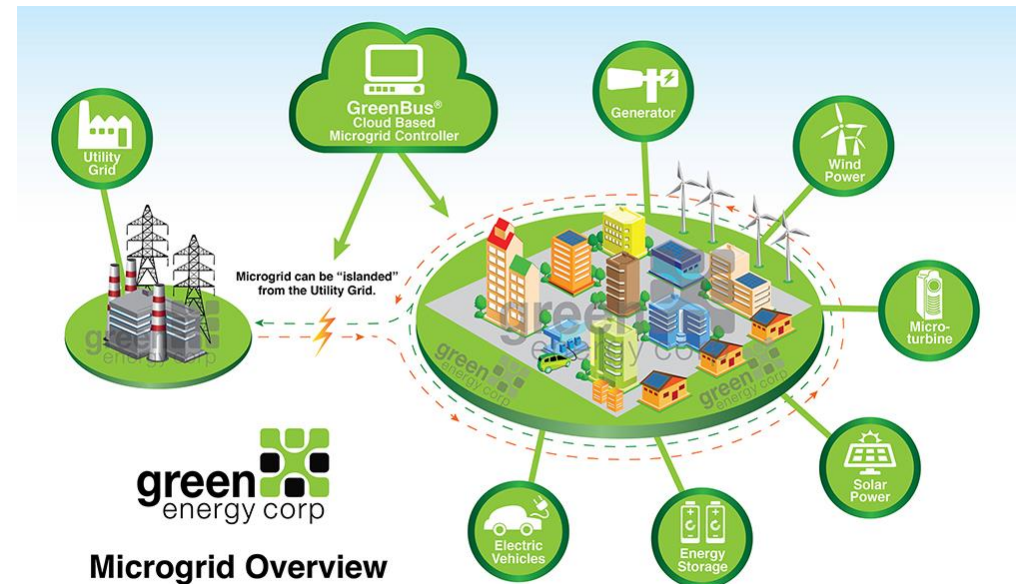
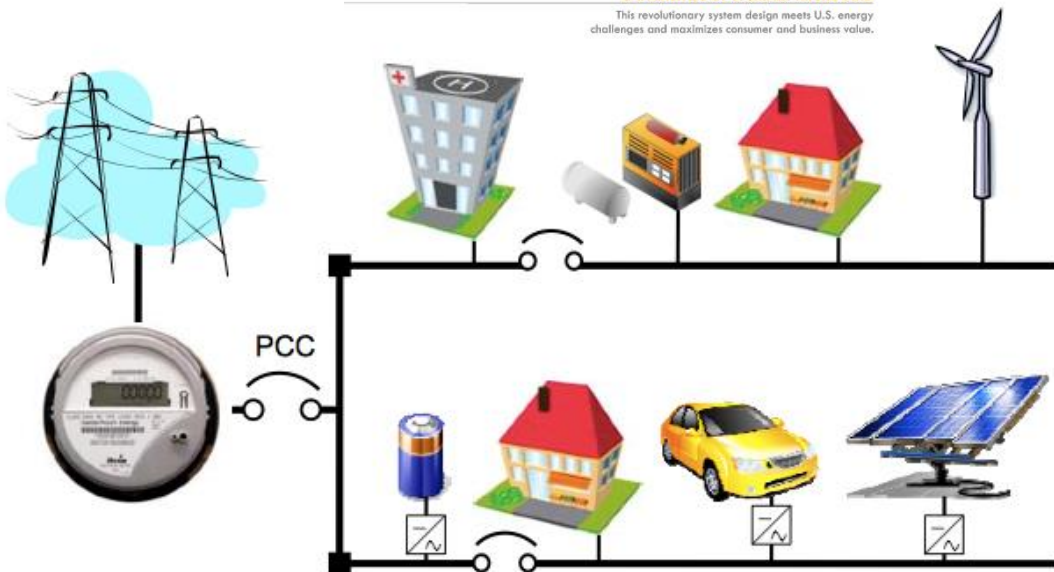

A global problem and a global grid as a solution?

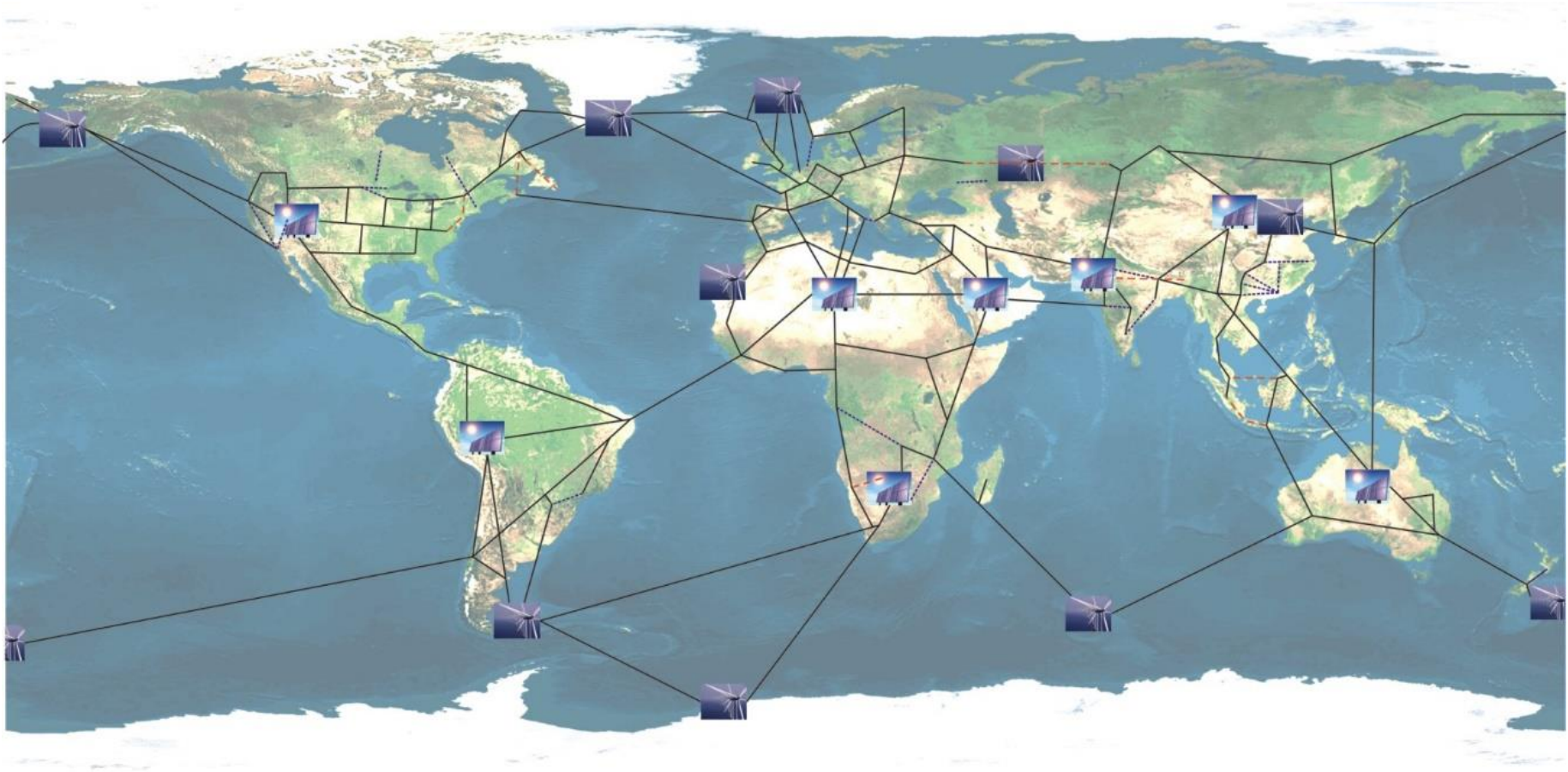

More at: <http://blogs.ulg.ac.be/damien-ernst/tedx-talk-the-global-grid-for-empowering-renewable-energy/>

Why a global supergrid?

- 1.** In many countries, you have only a limited number of prime locations for harvesting renewable energy
- 2.** Intermittency of renewable energy sources
- 3.** Tapping into rich veins of renewable energy sources

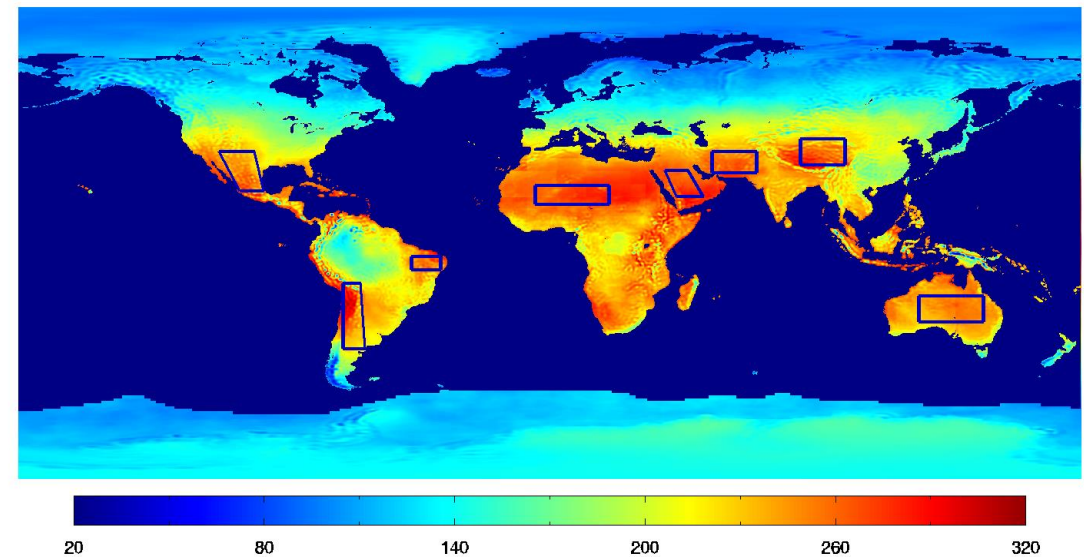
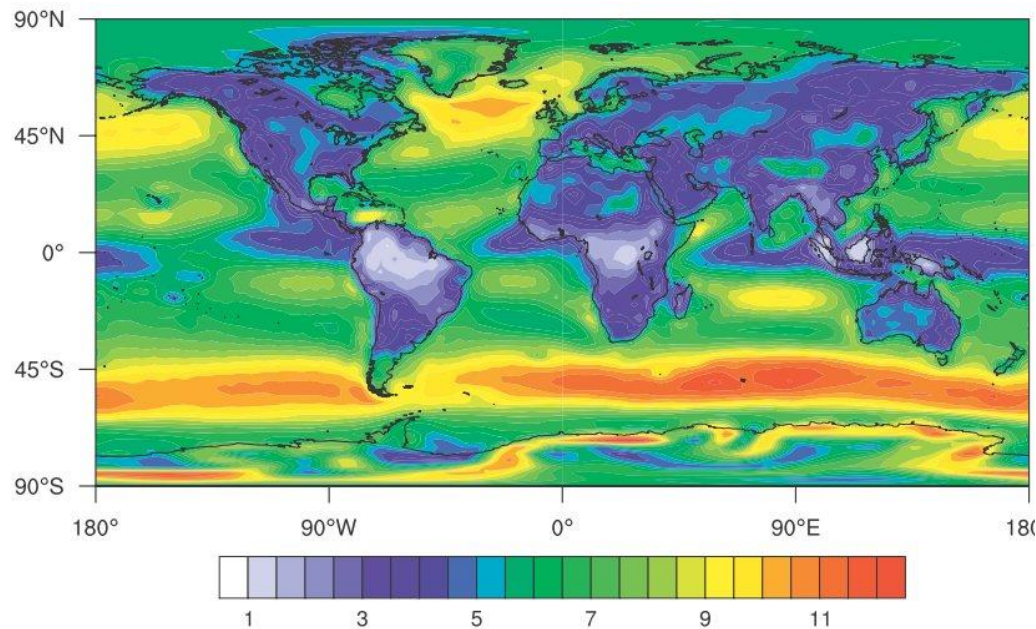

The electrical grid as it used to be

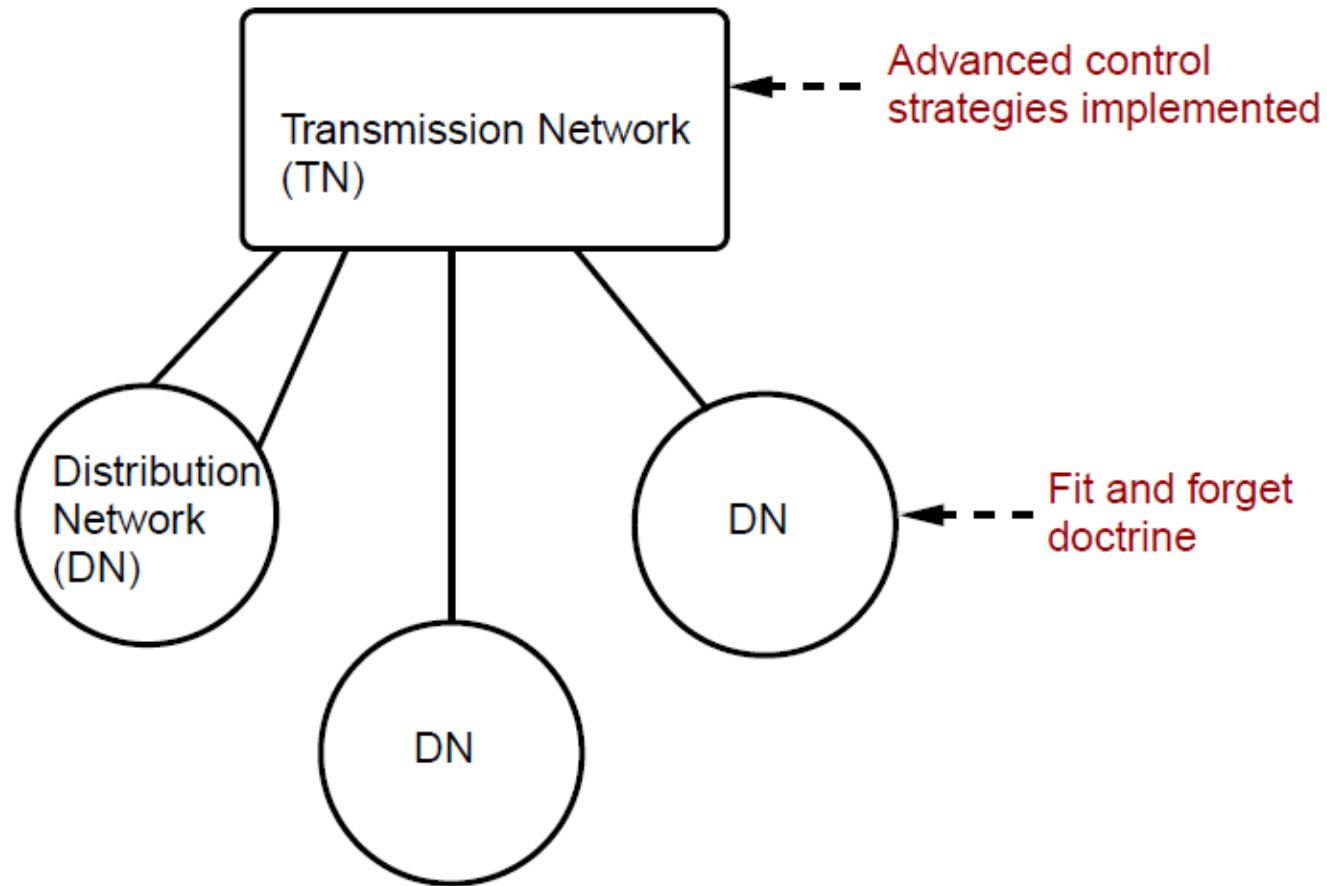

The electrical grid as it should become

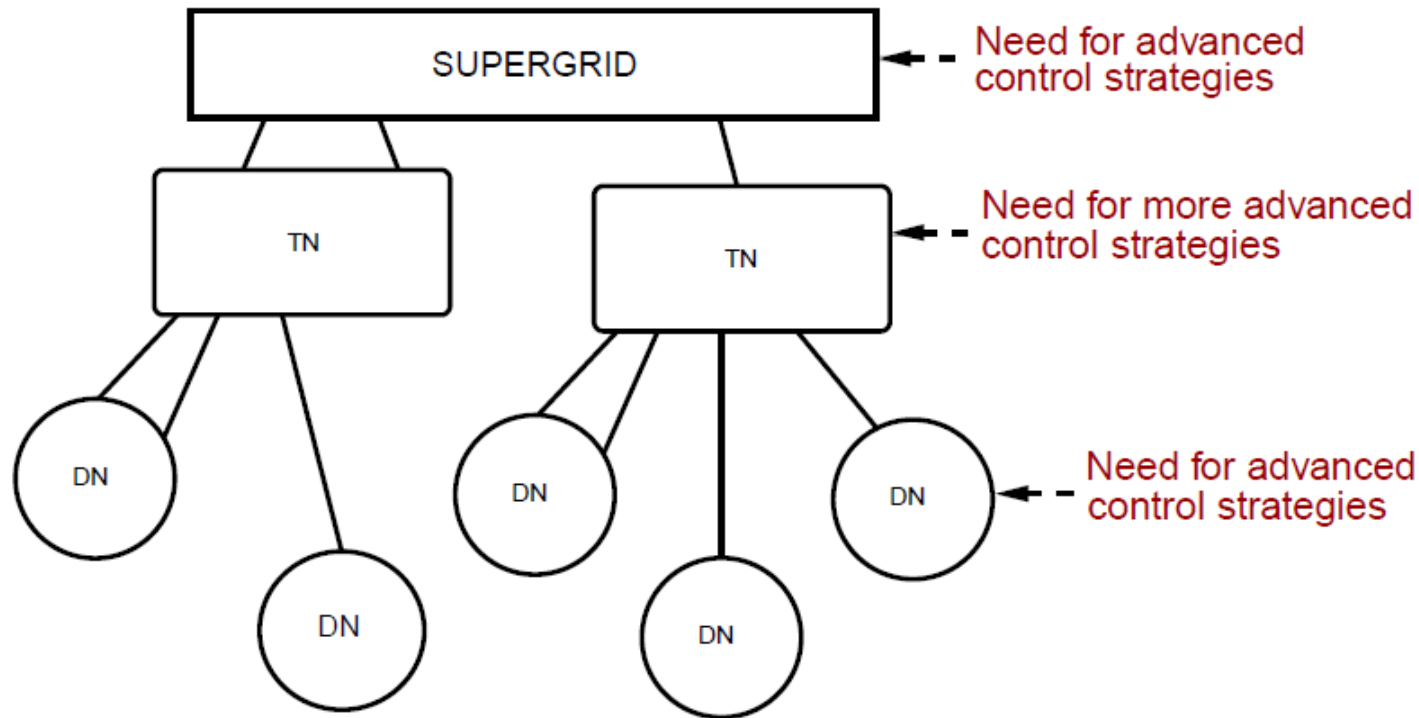

Challenges for designing top-performing control strategies and making them work together are **immense, especially in a deregulated (market) environment.**