



**“La vraie faute est celle
qu’on ne corrige pas ...”**

Confucius

An introduction to optical/IR interferometry

Brief summary of main results obtained during the last lecture:

$$V = \left| \gamma_{12}(0, u, v) \right| = \left| \iint_S I'(\xi, \eta) \exp\{-i2\Pi(u\xi + v\eta)\} d\xi d\eta \right|$$

$$I'(\xi, \eta) = \iint \gamma_{12}(0, u, v) \exp\{i2\Pi(\xi u + \eta v)\} d(u)d(v)$$



- For the case of a 1D uniformly brightening star whose angular diameter is $\phi = b/z'$, we found that the visibility of the fringes is zero when $\lambda/B = b/z' = \phi$ where B is the baseline of the interferometer

- For the case of a double star with an angular separation $\phi = b/z'$, we found that the visibility of the fringes is zero when $\lambda/2B = b/z' = \phi$

An introduction to optical/IR interferometry

- 5 Light coherence
- 5.5 Aperture synthesis

Exercises:

- the case of a gaussian-like source?
- let us assume that the observed visibility $|\Upsilon_{12}(0, u)|$ of a celestial object is $|\cos(\pi u \theta)|$, please retrieve the intensity distribution I' of the source

Case of a double point-like source with a flux ratio = 1

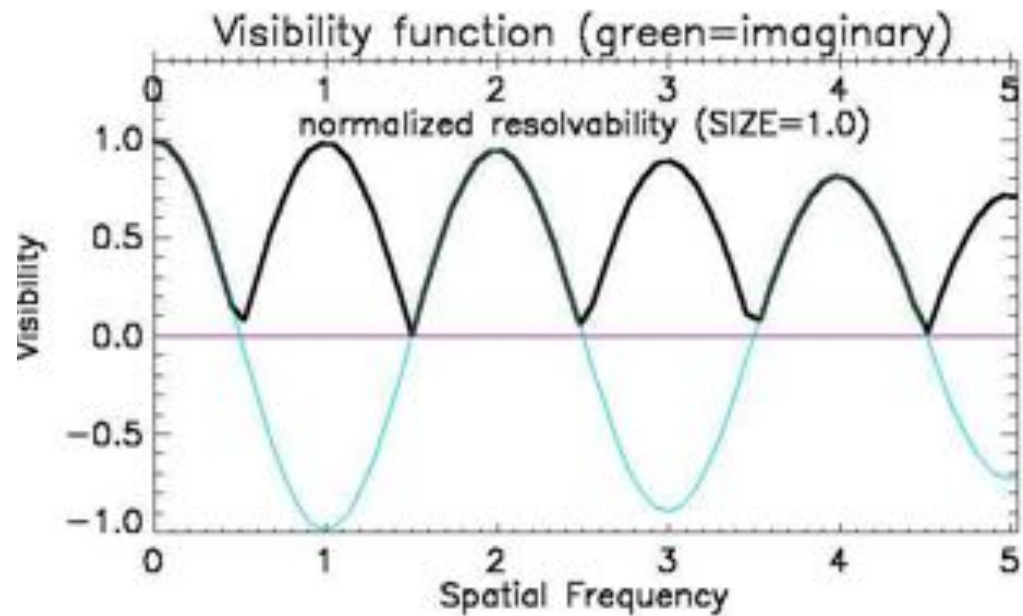

Case of a double point-like source with a flux ratio 0.7/0.3

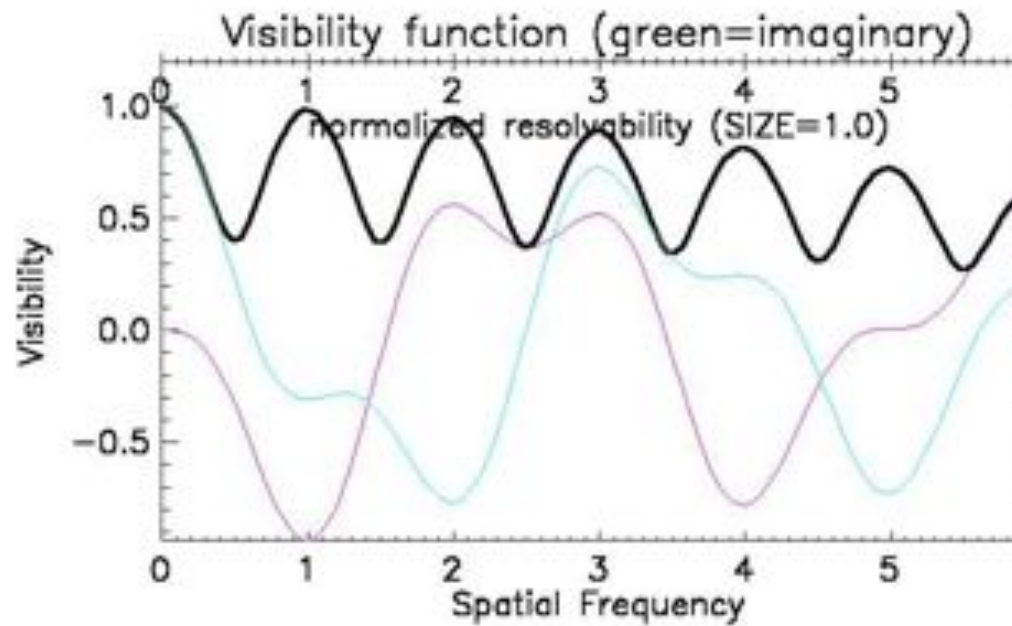

Variation of the fringe contrast as a function of the angular separation between the two stars:



If the source is characterized by a uniform disk light distribution, the corresponding visibility function is given by

$$v = \left(\frac{I_{\max} - I_{\min}}{I_{\max} + I_{\min}} \right) = |\gamma_{12}(0)| = TF(I) = \frac{2J_1(\pi\theta_{UD}B/\lambda)}{\pi\theta_{UD}B/\lambda}$$

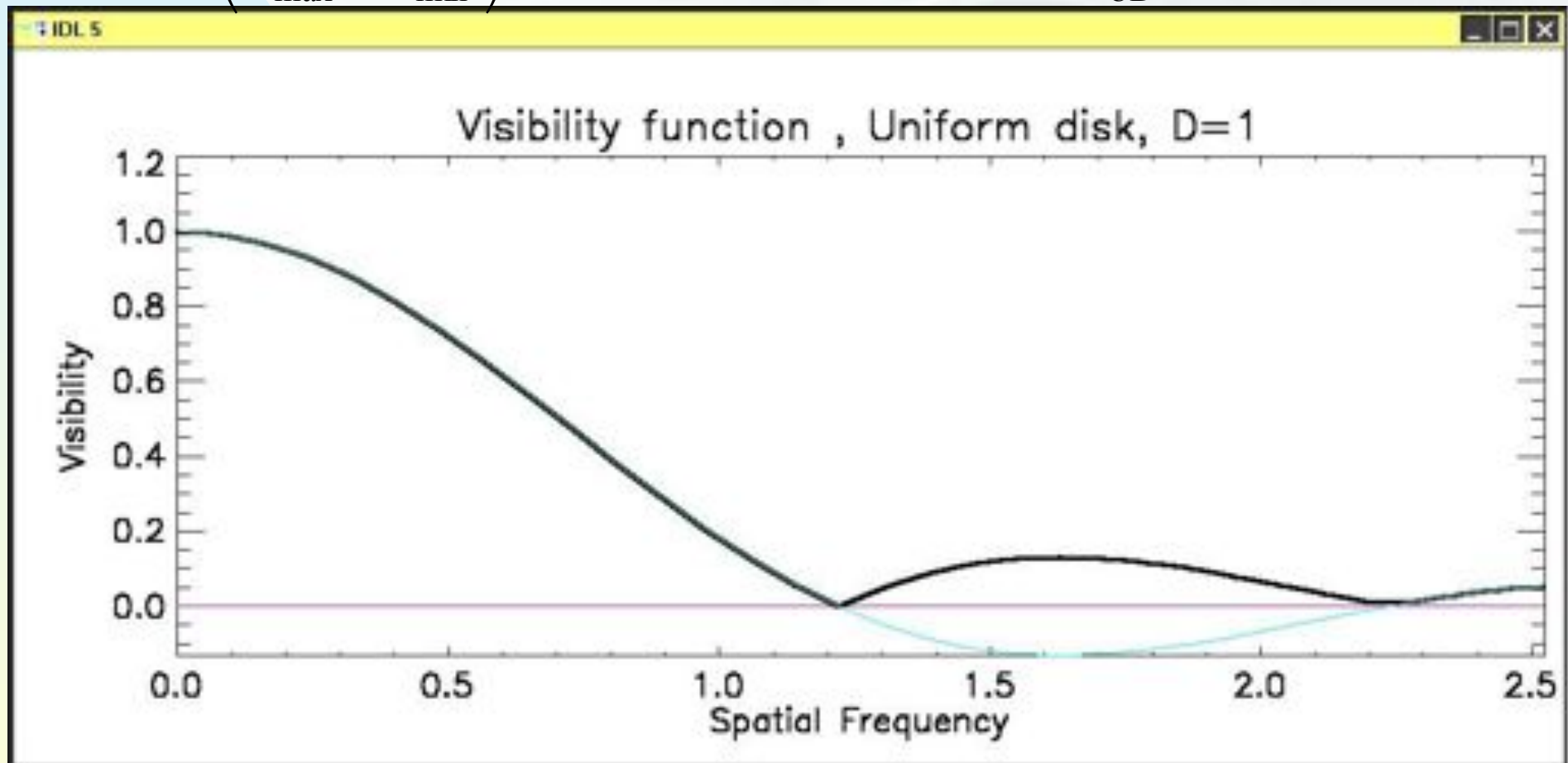

SW Virginis M7.3 III semi-regular variable in 1996 & 1997

$$V_{\text{DC}}(B) = \frac{2J_1\left(\pi\theta\frac{B}{\lambda}\right)}{\pi\theta\frac{B}{\lambda}}$$

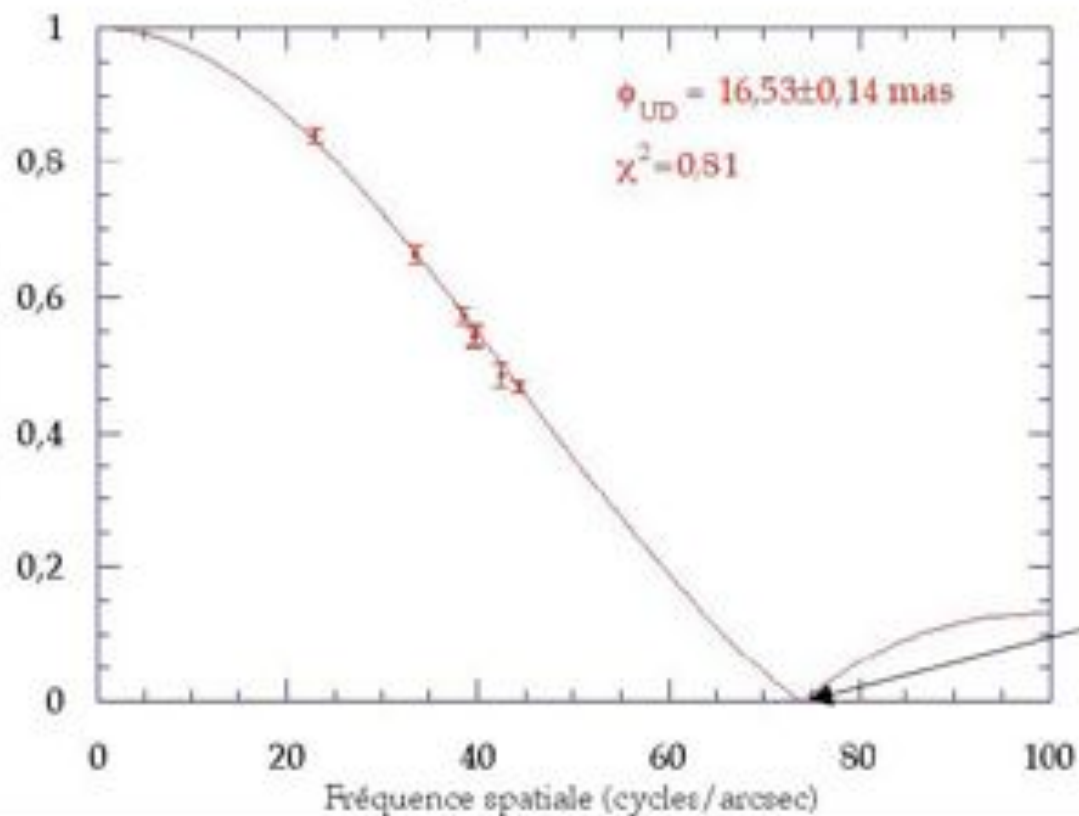

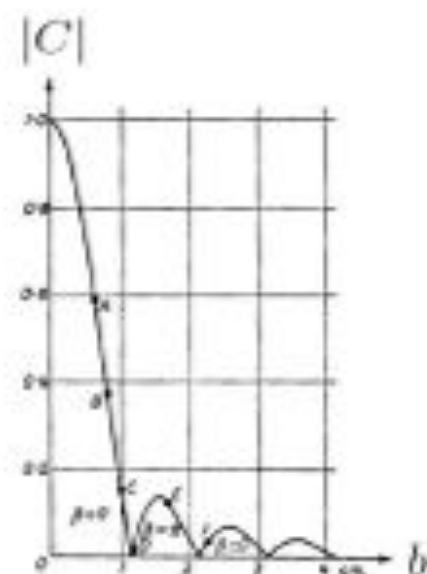
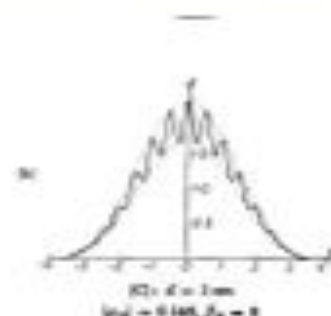
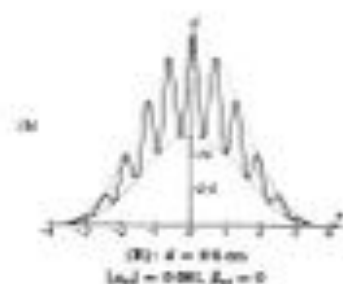
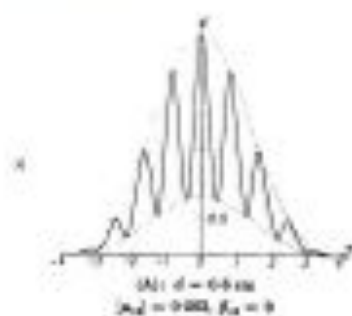

$$I(x) = I_1 + I_2 + 2\sqrt{I_1 I_2} |C| \cos\left(\frac{bx}{\lambda} + \phi_C\right) \text{ with } |C| = \frac{I_{\max} - I_{\min}}{I_{\max} + I_{\min}}$$

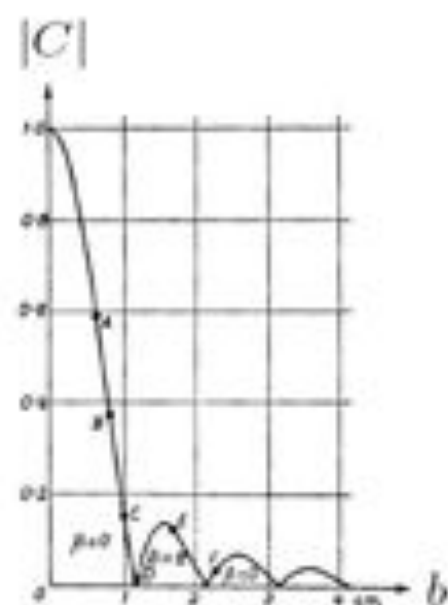
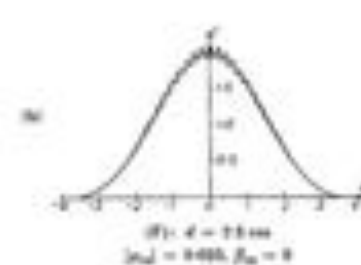
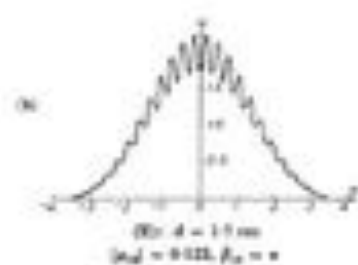
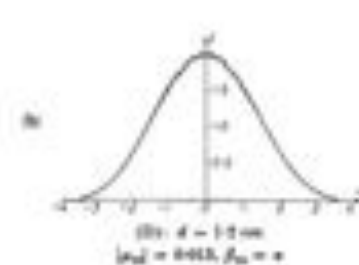

$$I(x) = I_1 + I_2 + 2\sqrt{I_1 I_2} |C| \cos\left(\frac{bx}{\lambda} + \phi_C\right) \quad \text{with} \quad |C| = \frac{I_{\text{max}} - I_{\text{min}}}{I_{\text{max}} + I_{\text{min}}}$$

For the case of the Sun:

$$\vartheta_{\text{UD}} = 1.22\lambda / B = 1.22 \cdot 0.55 / B(\mu) = 30' \times 60'' / 206265$$

$$B(\mu) = 206265 \times 1.22 \times 0.55 / (30 \times 60) = 76.9 \mu$$

$$d(\mu) = 7.2 \text{ or } 14.4 \mu \rightarrow \sigma = 2.44 \lambda / d = 7.8^\circ \text{ or } 3.9^\circ$$

See the masks!



First
fringes
on the
Sun:
9/4/2010

$$B = 29.4\mu$$
$$d = 11.8\mu$$

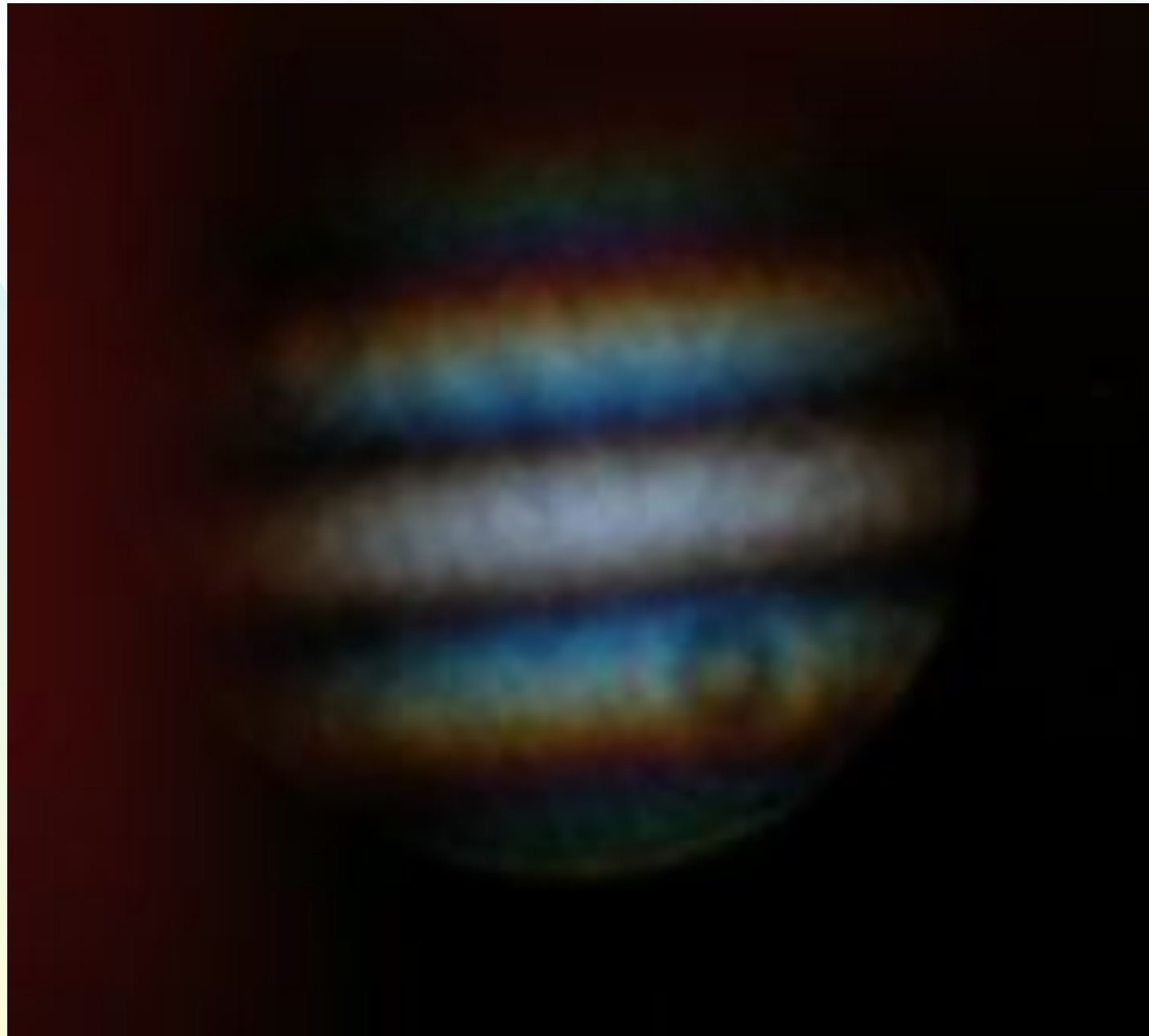

OVLA PSF

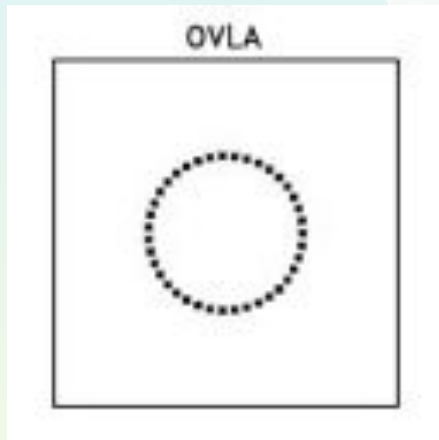

↔ 50 μ

• 14 μ



OVLA_Sun_2



ELSA PSF

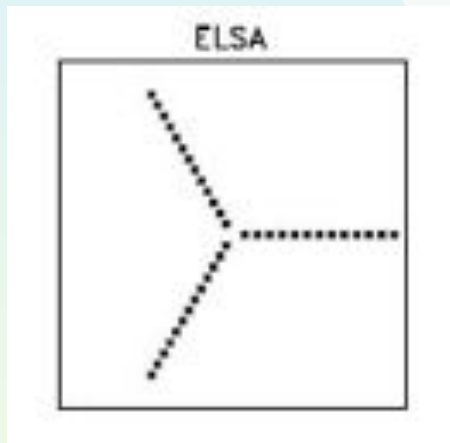

↔ 50μ

• 14μ



ELSA_Sun_24





Interferometric observations on 10/4/2010 of Procyon, Mars and Saturn, using the 80cm telescope at Haute-Provence Observatory and adequate masks (coll. with Hervé le Coroller) ...



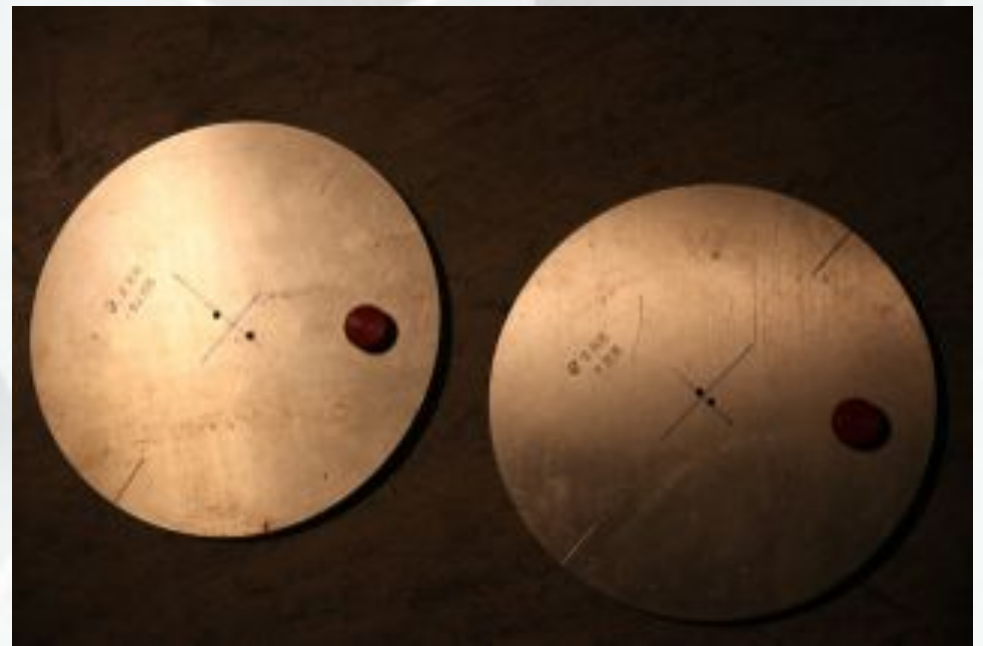

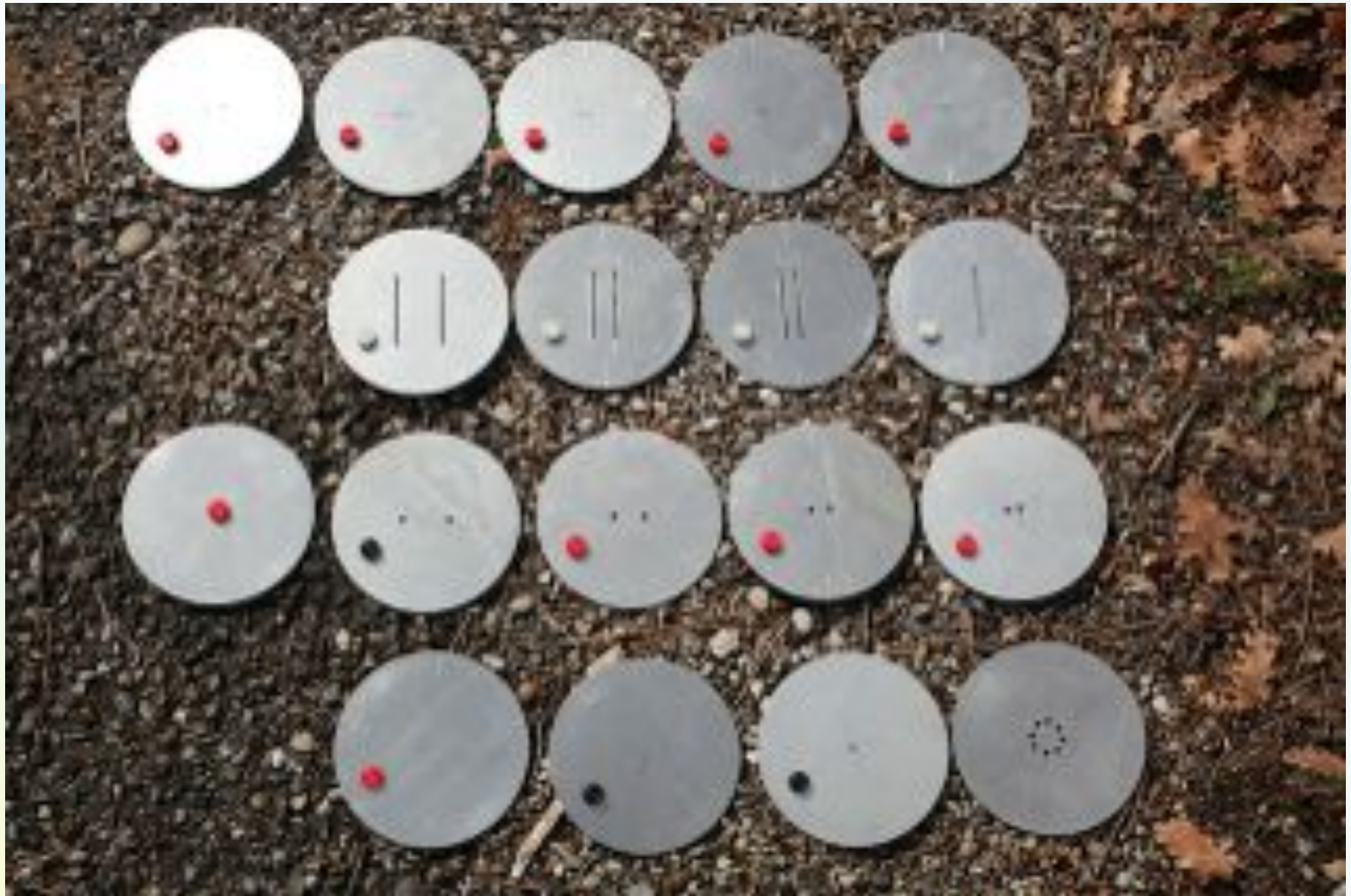

Procyon
 $B = 12 \text{ mm}$
 $d = 2 \text{ mm}$

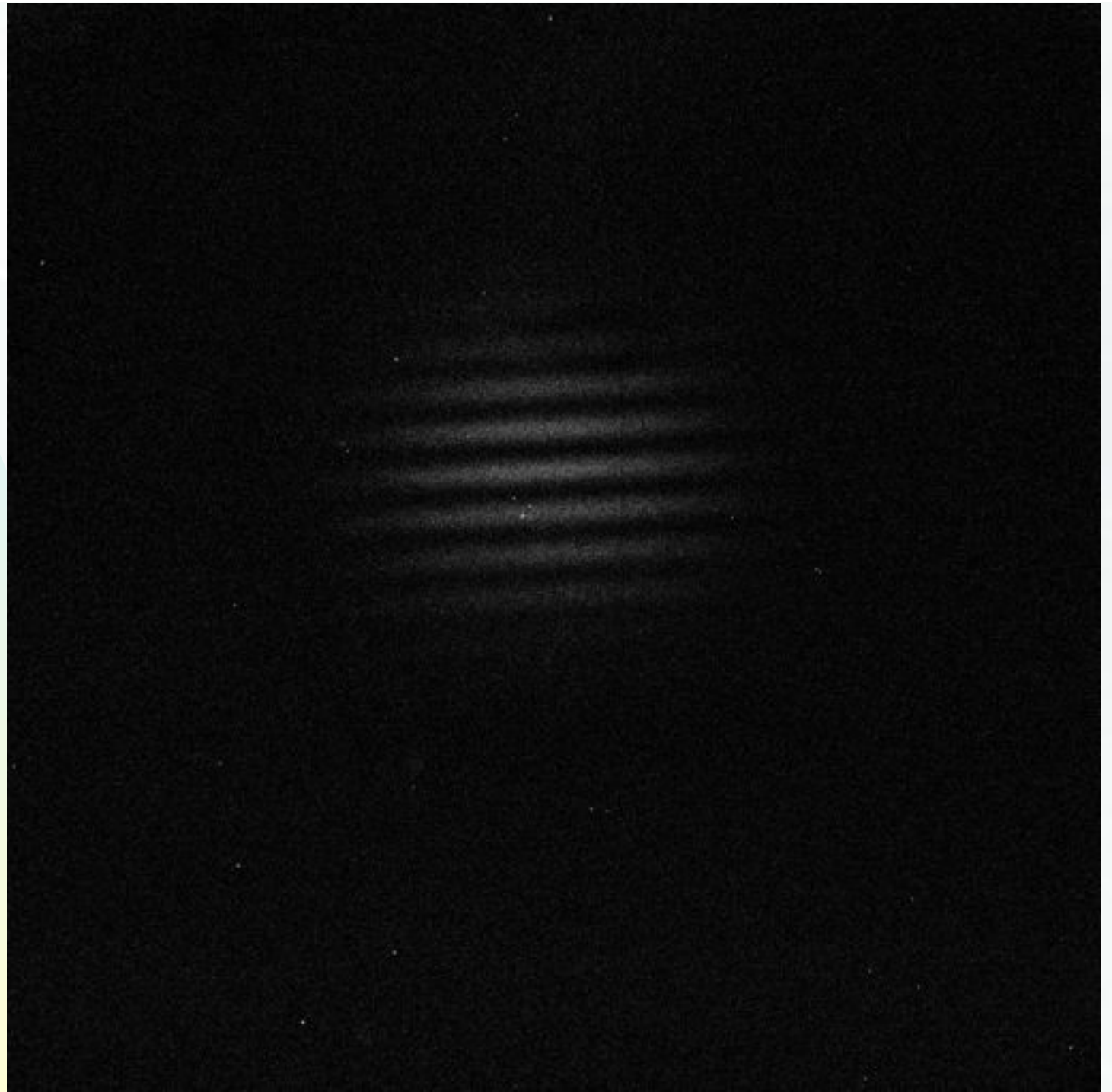

Mars

$B = 12 \text{ mm}$

$d = 2 \text{ mm}$

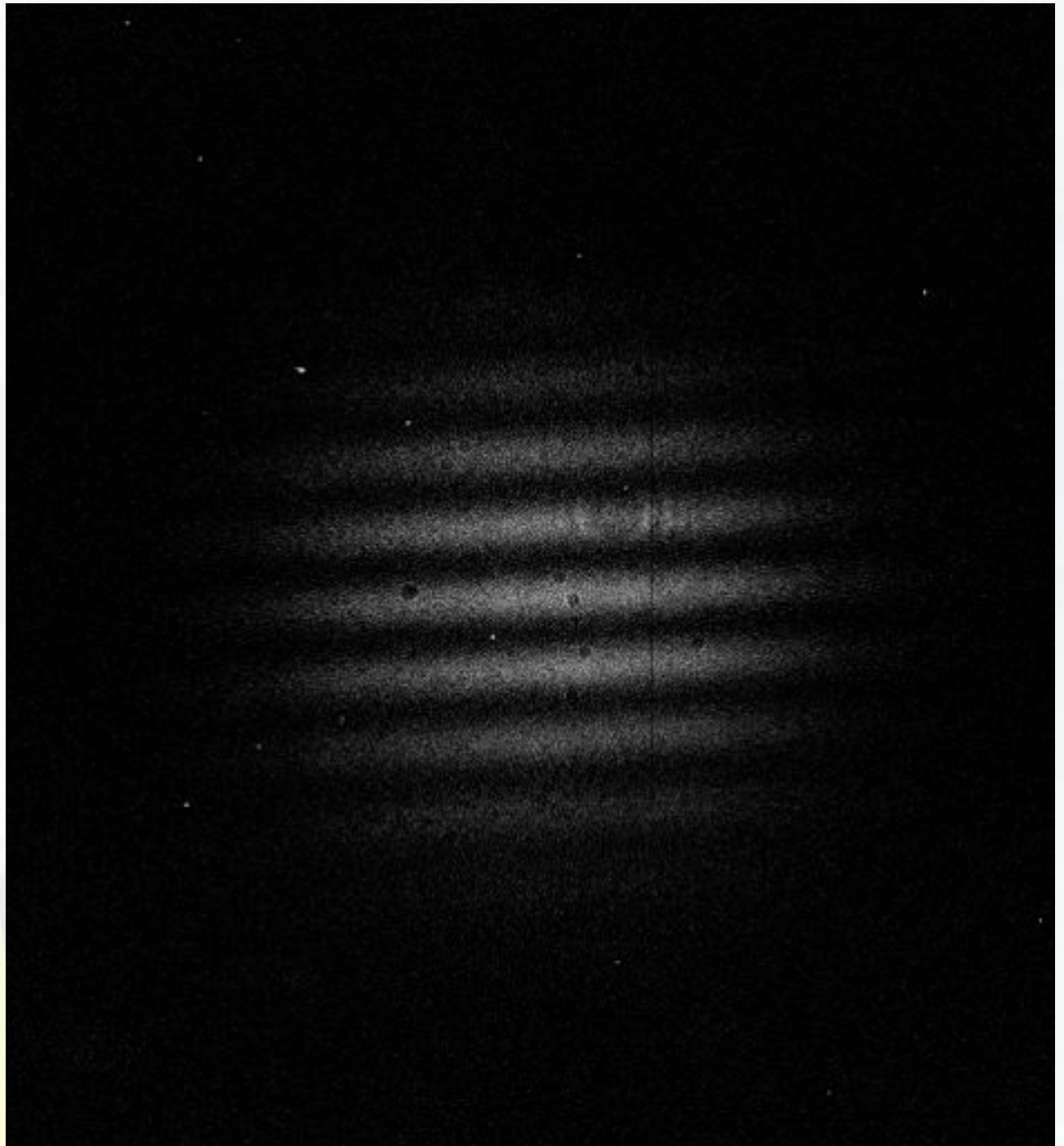

Saturn

$B = 4 \text{ mm}$

$d = 2 \text{ mm}$

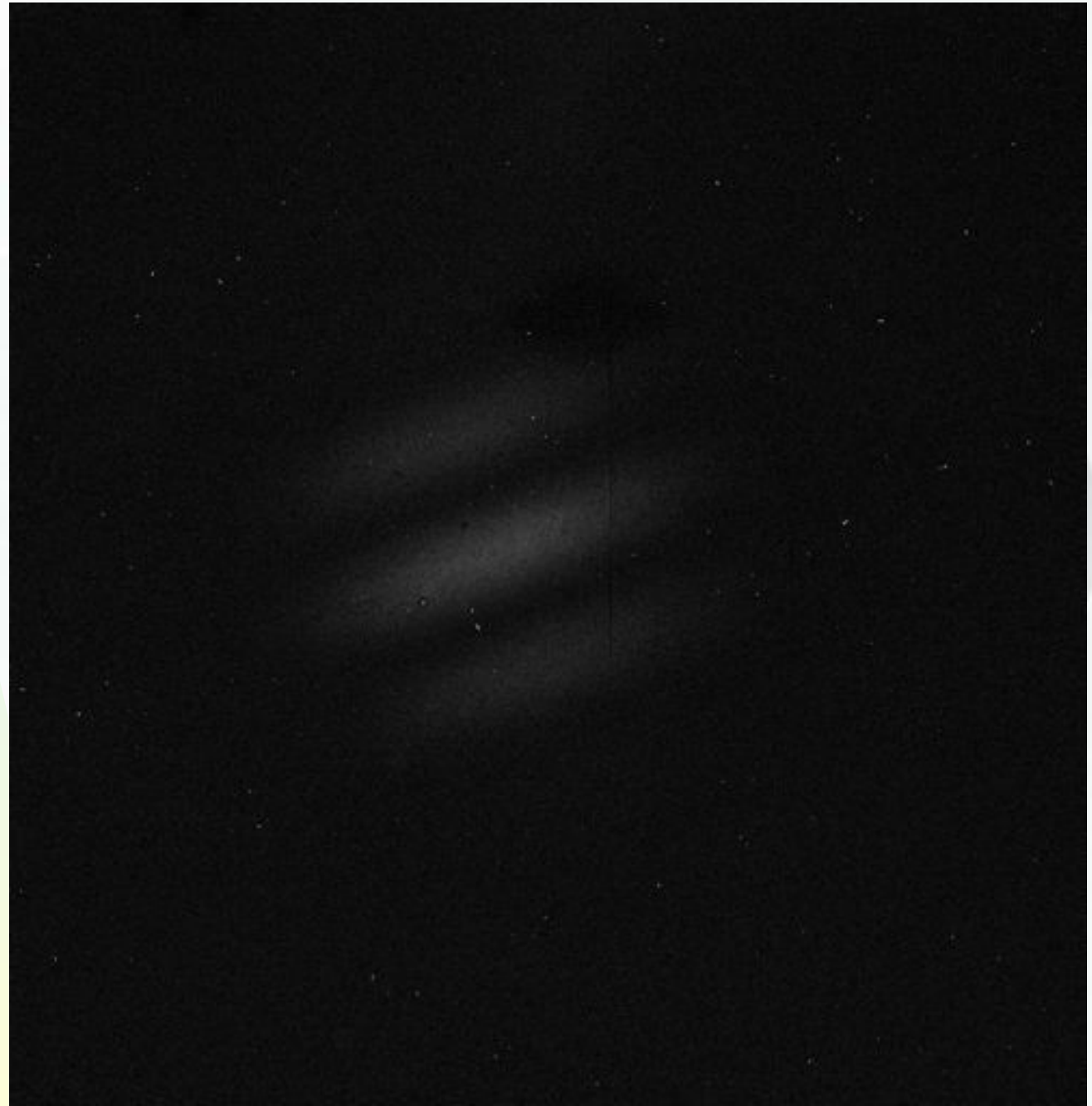

Saturn

$B = 12 \text{ mm}$

$d = 2 \text{ mm}$

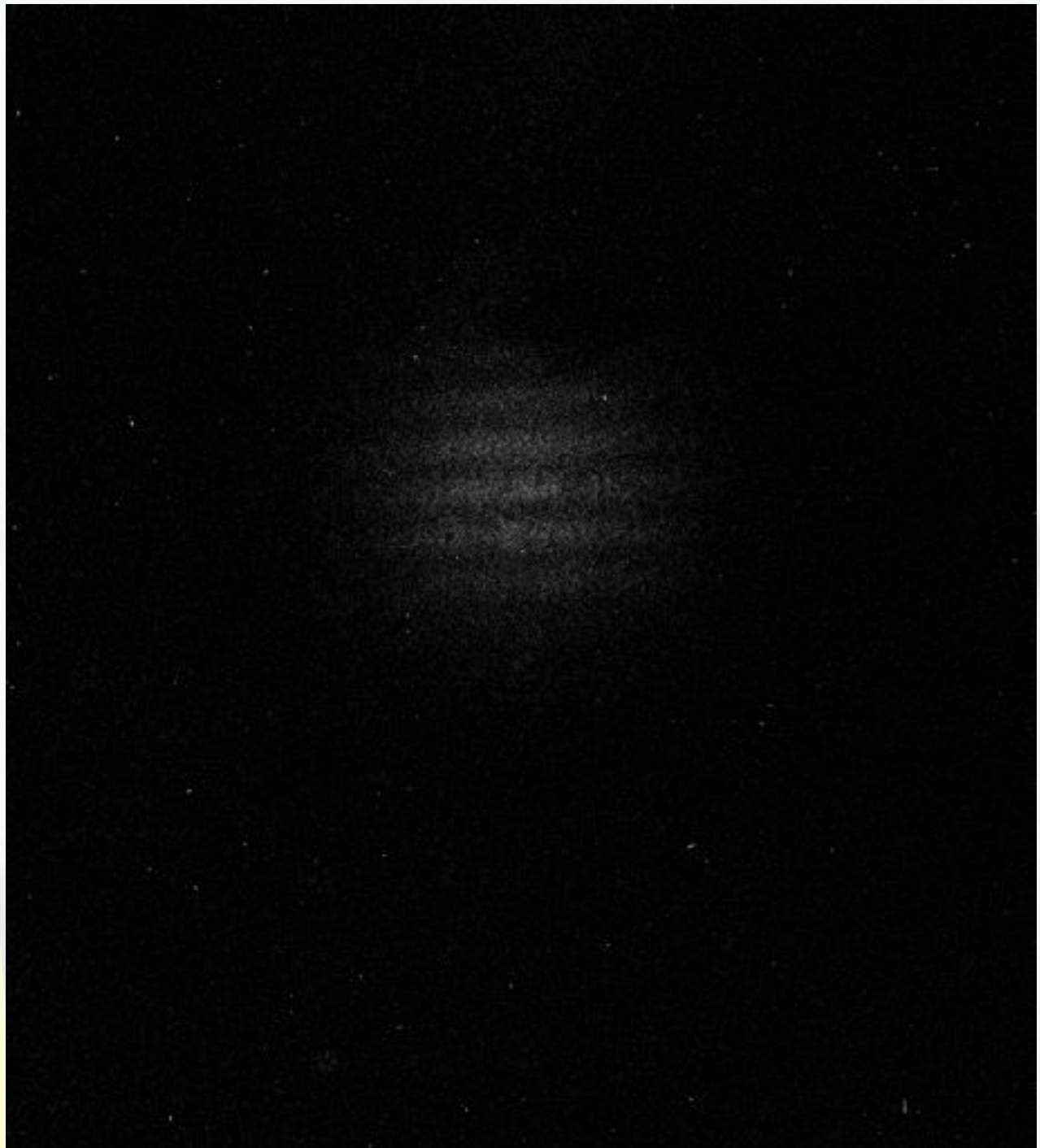

An introduction to optical/IR interferometry

- 6 Some examples of optical interferometers



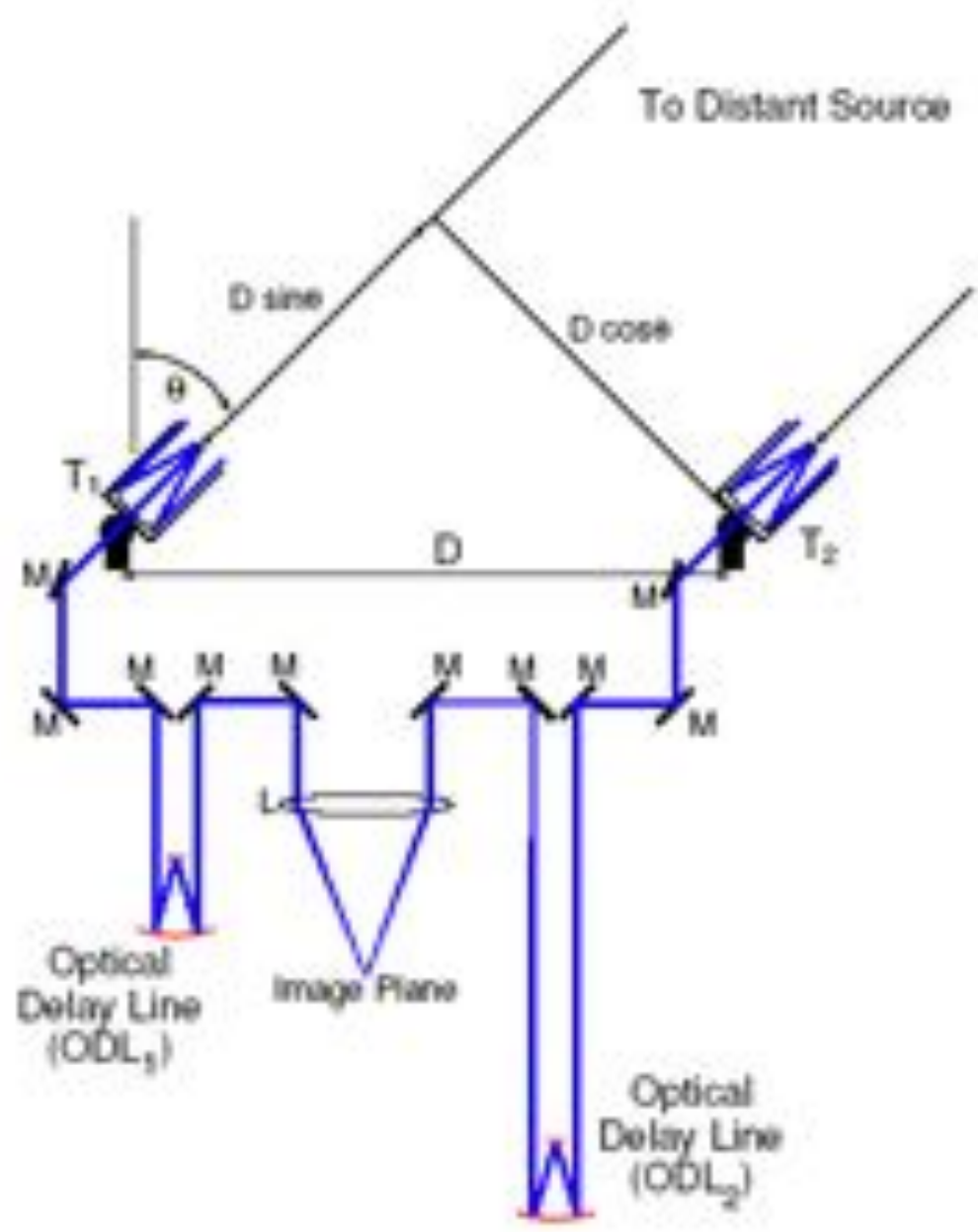

First fringes with I2T

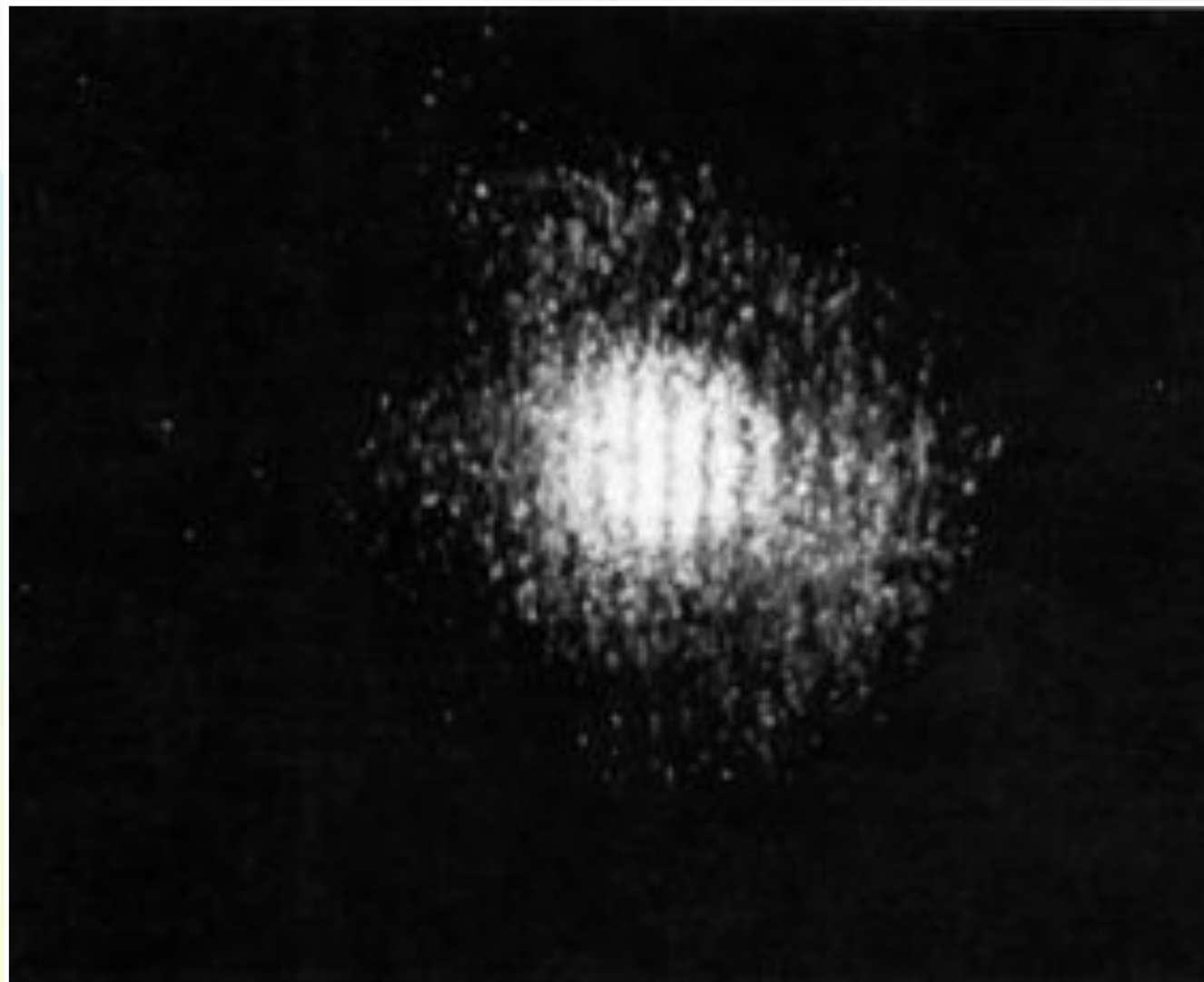

Antoine Labeyrie, "Interference fringes obtained on Vega with two optical telescopes," *Astrophys. J.* L71-L75 (1975)



I2T



GI2T

An introduction to optical/IR interferometry

- 6 Some examples of optical interferometers

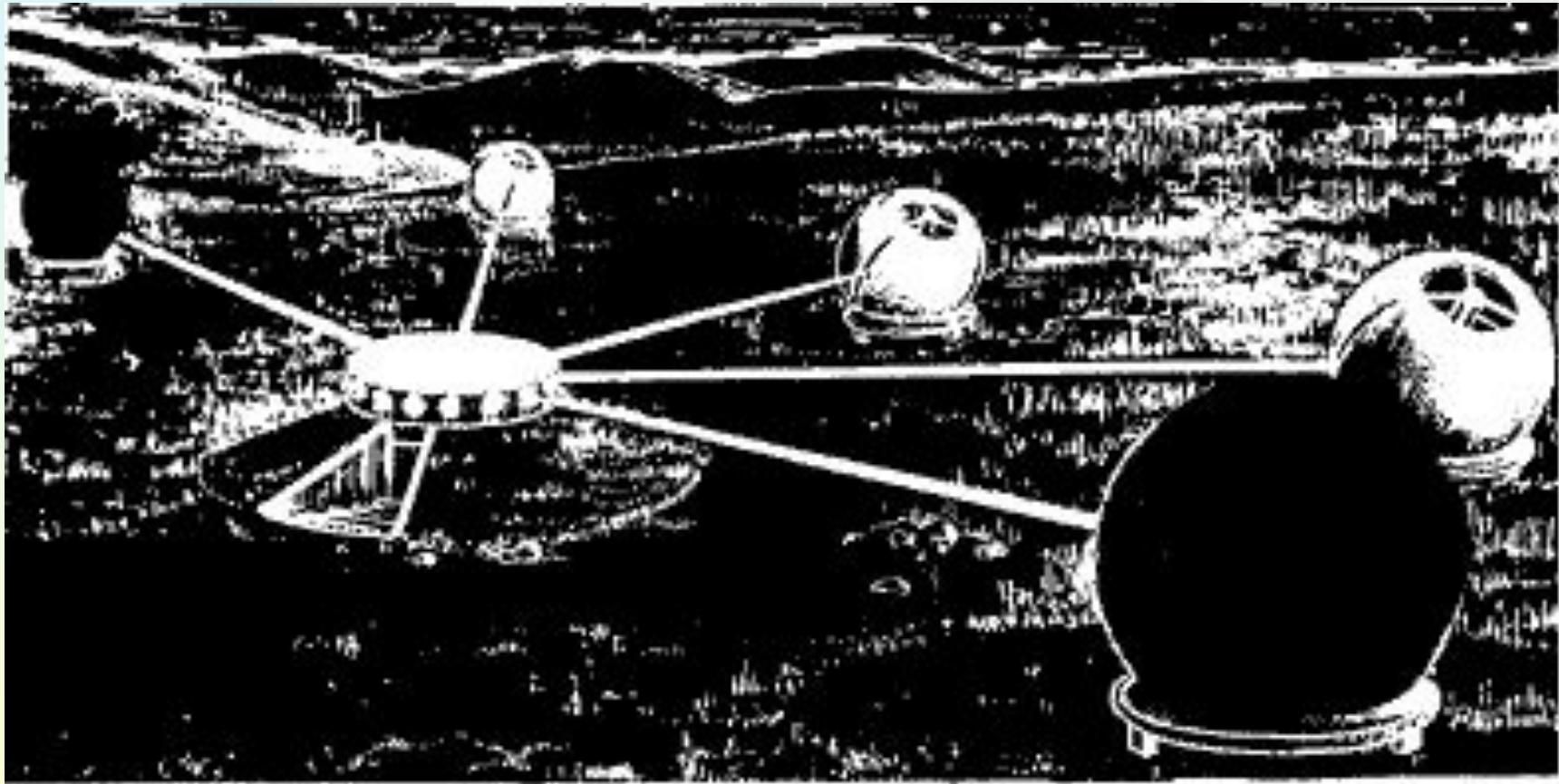

An introduction to optical/IR interferometry

- 6 Some examples of optical interferometers

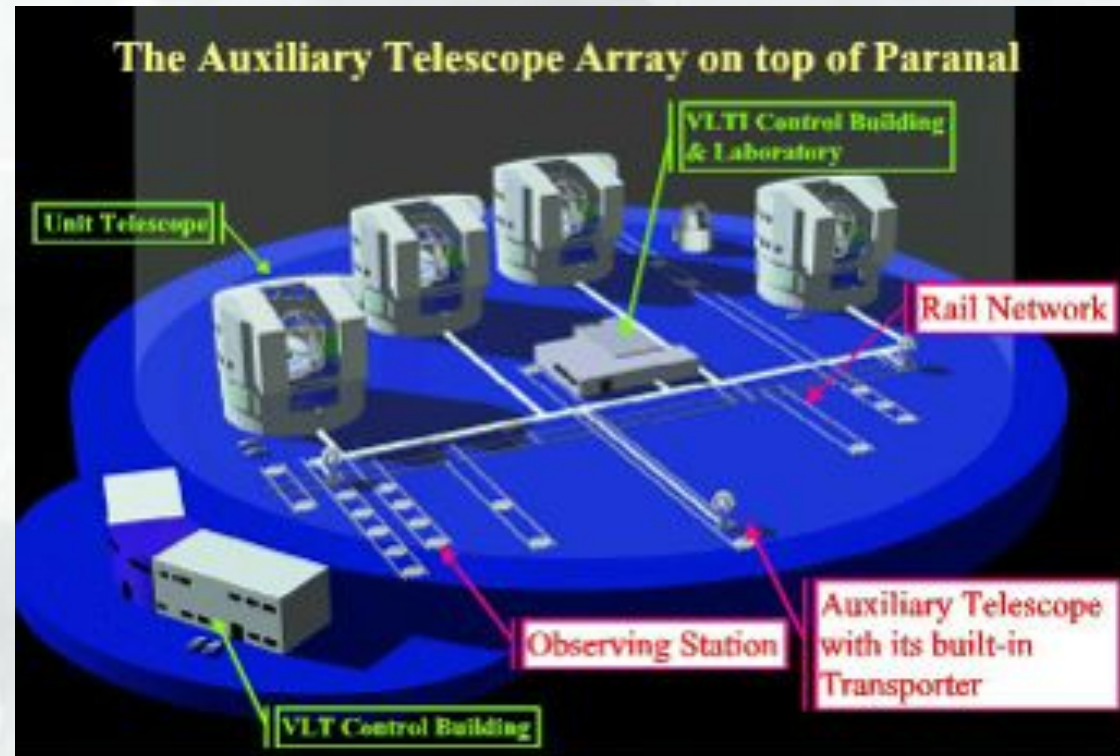

An introduction to optical/IR interferometry

- 6 Some examples of optical interferometers

Interferometry to-day is:

Very Large Telescope
Interferometer (VLTI)

- 4 x 8.2m UTs
- 4 x 1.8m ATs
- Max. Base: 200m

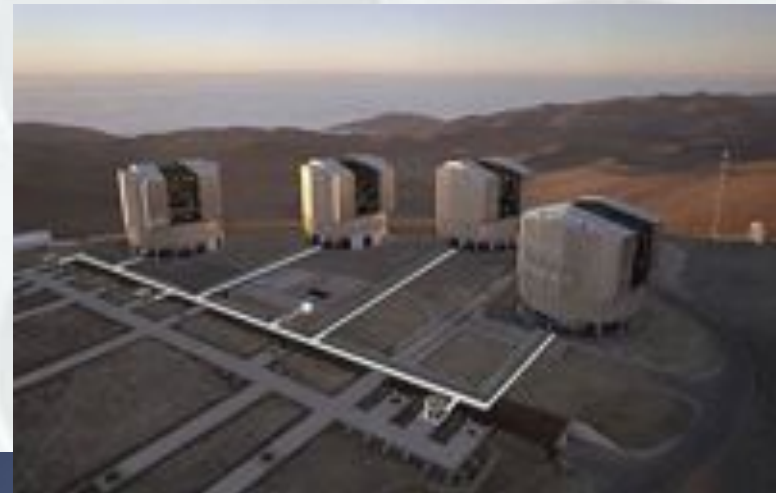



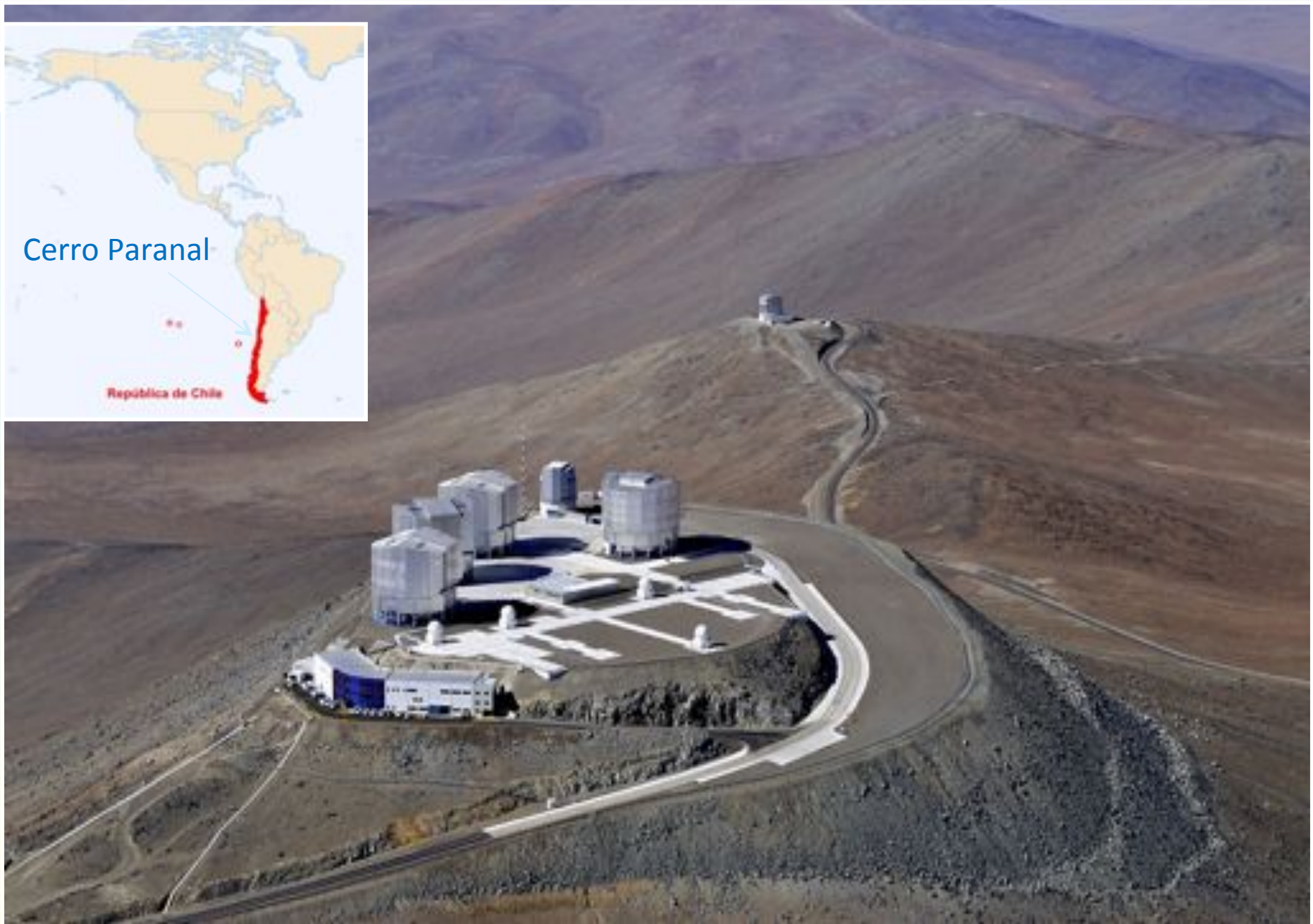

An introduction to optical/IR interferometry

- 6 Some examples of optical interferometers



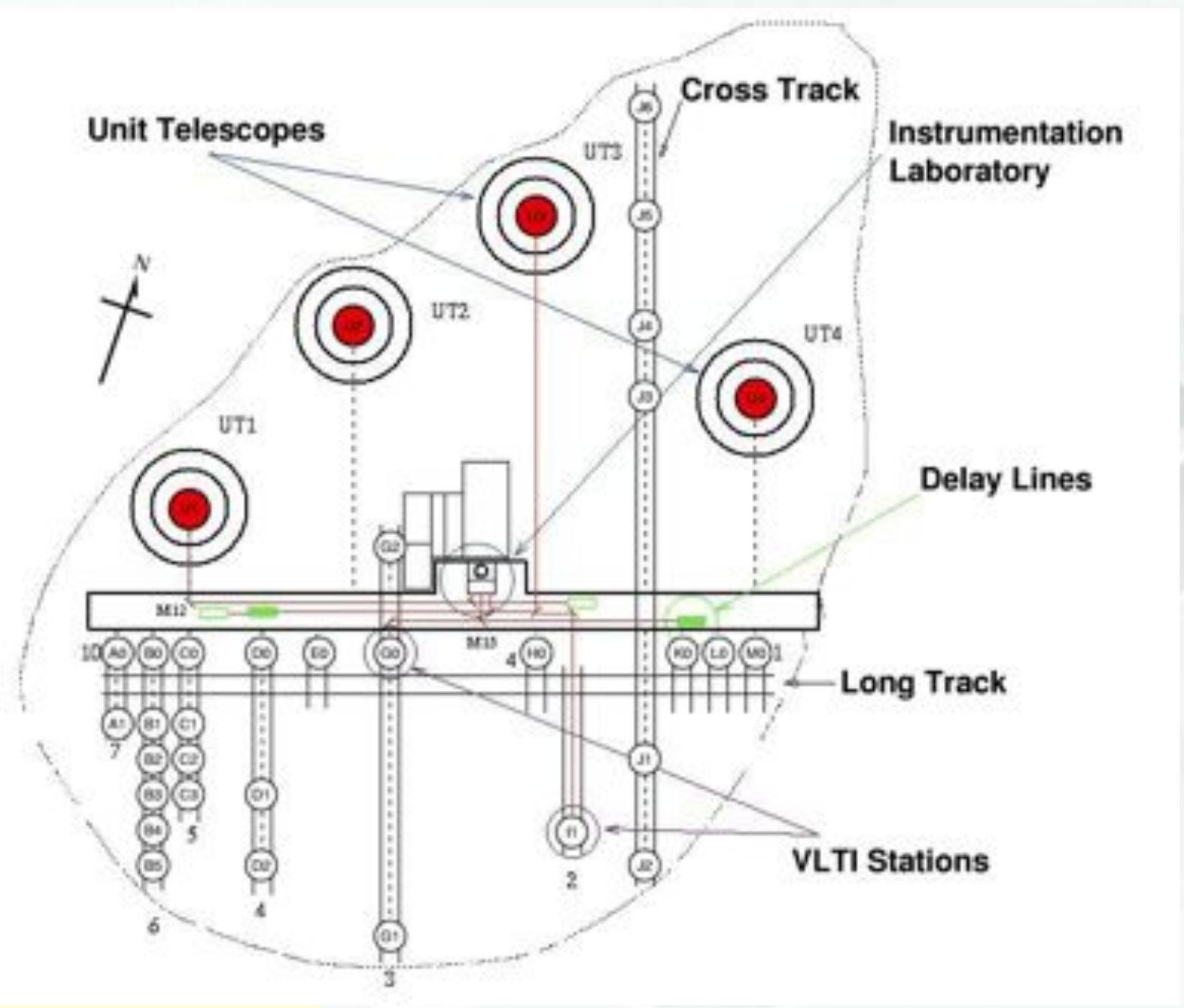

VLTI delay lines

VLTI (Chili)

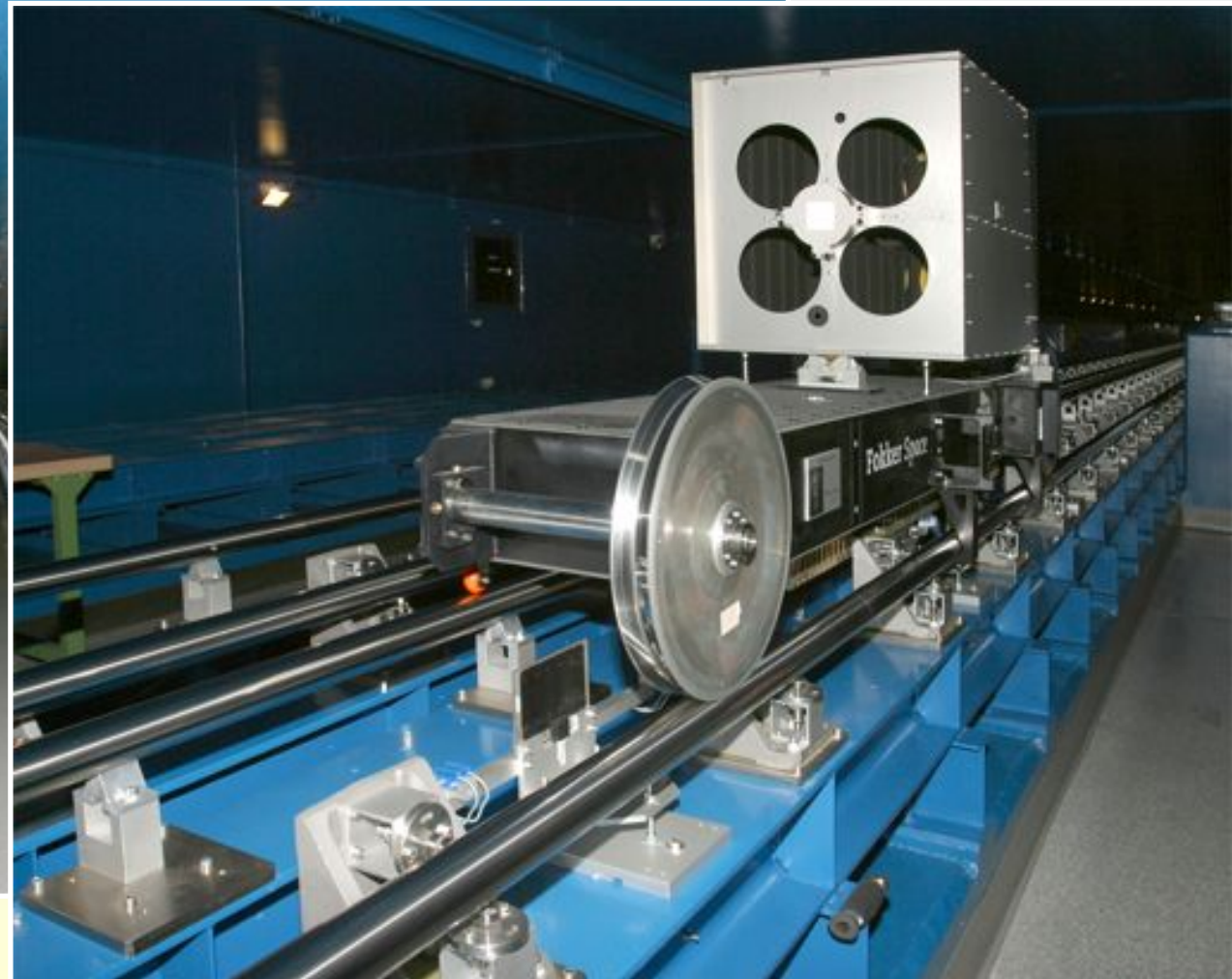

uv plane coverage

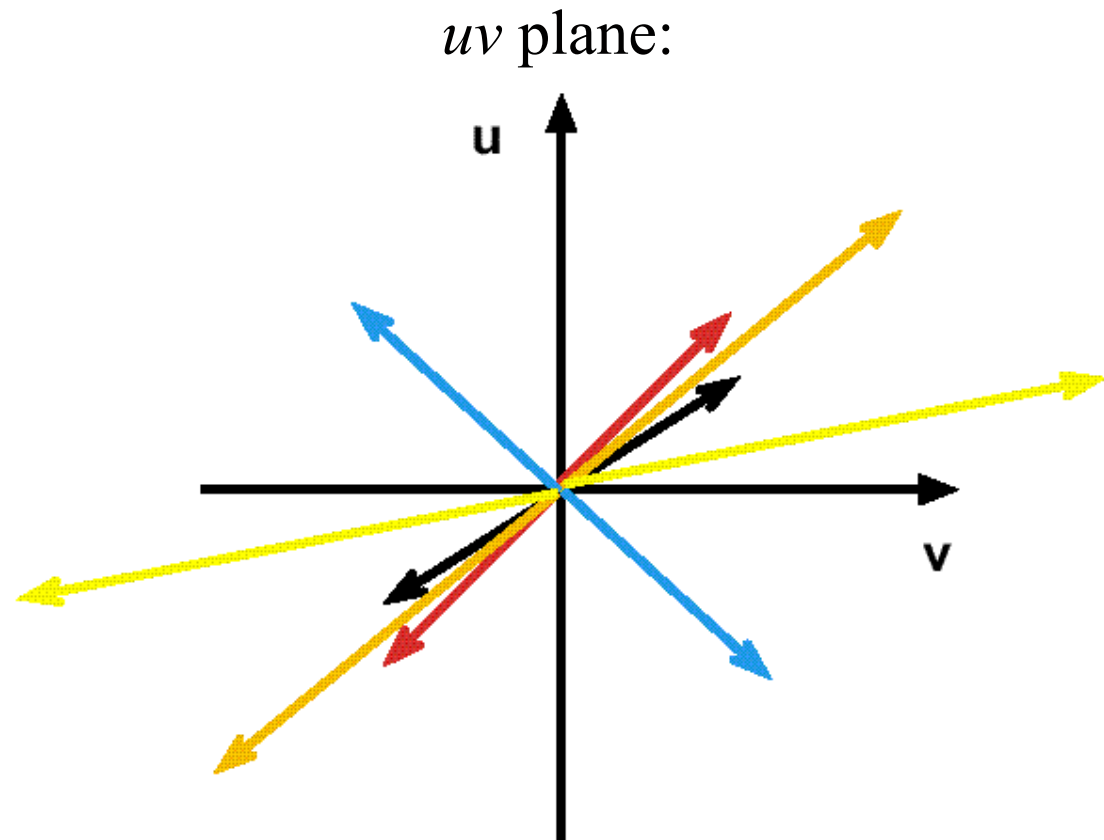
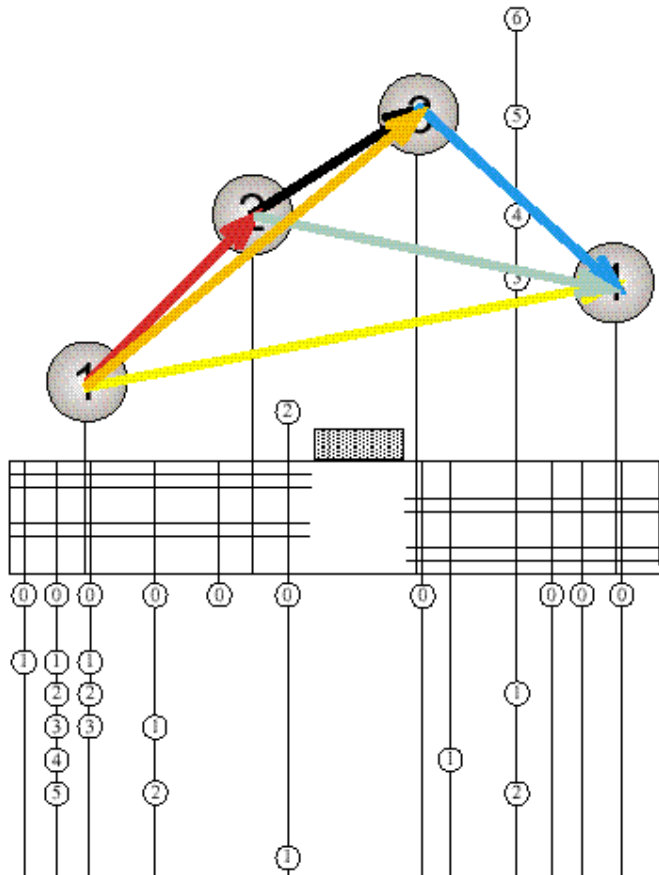

Note: uv plane coverage for an object at zenith. More generally, the projected baselines must be used.

Examples of uv plane coverage

Dec -15

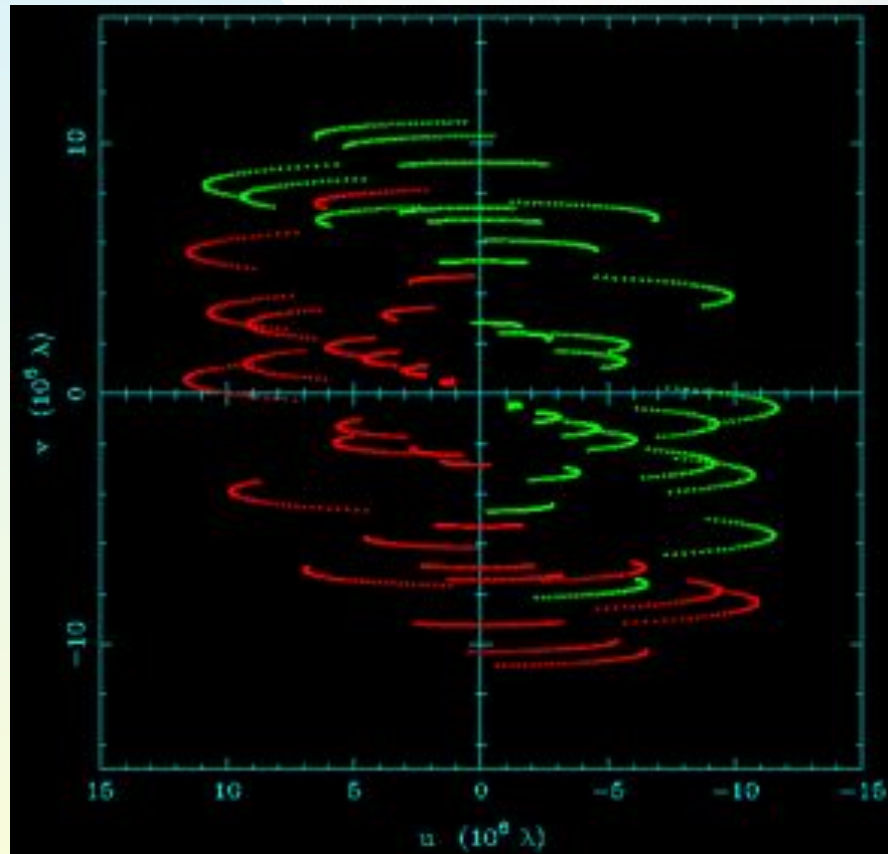

Dec -65

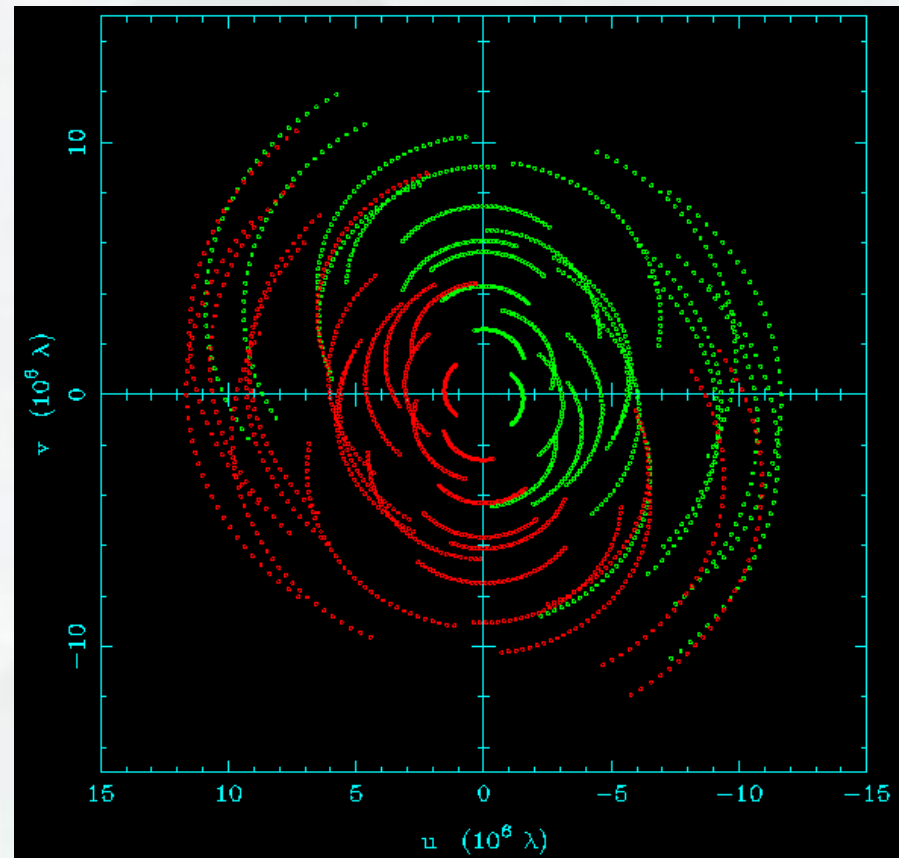

How does the uv plane coverage affect imagery?

Model

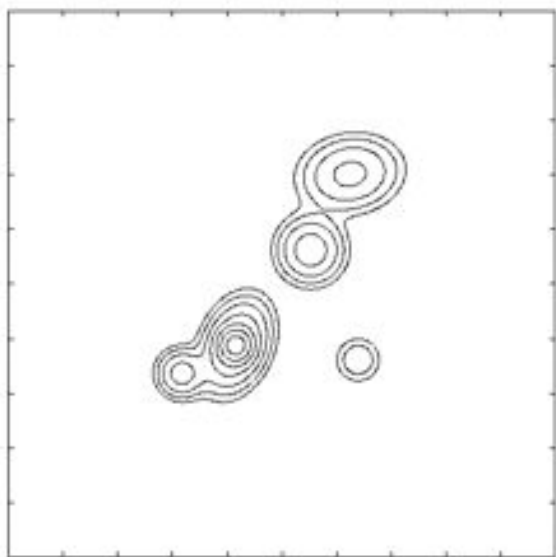

4 telescopes, 6 hrs

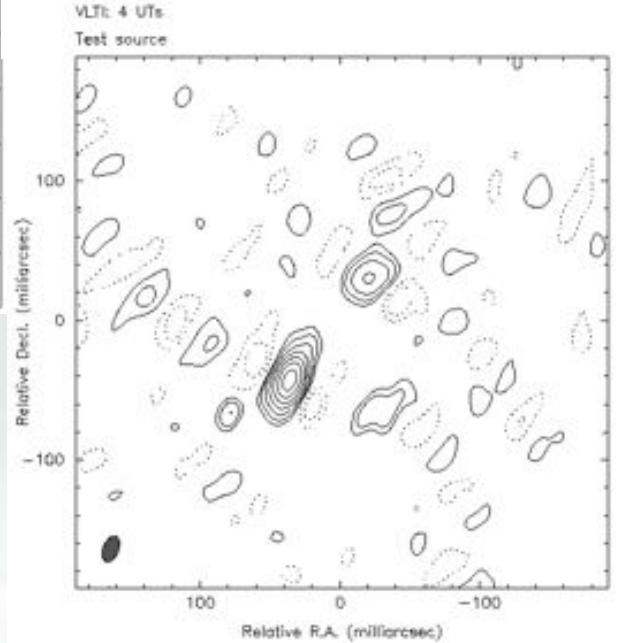
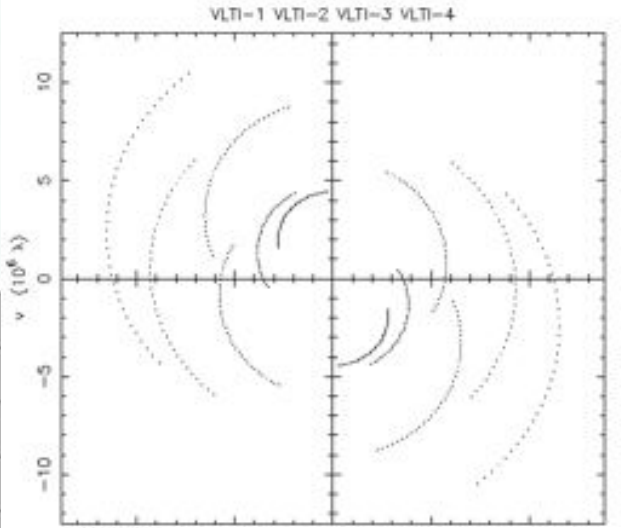

8 telescopes, 6 hrs

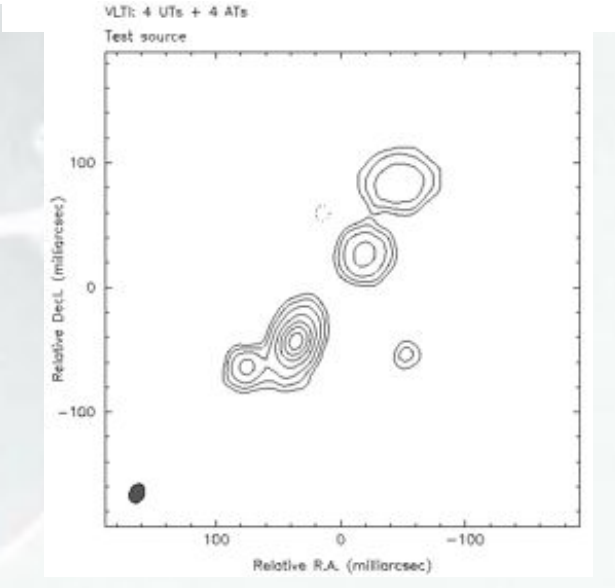
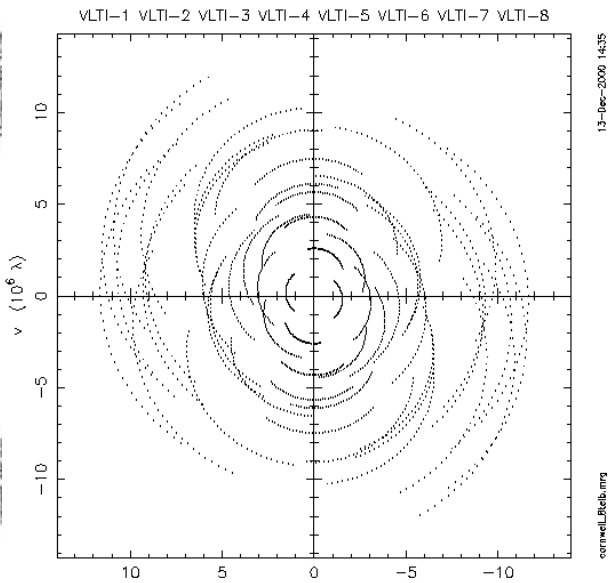

An introduction to optical/IR interferometry

- 6 Some examples of optical interferometers

Interferometry to-day is also:

The CHARA
interferometer

- 6 x 1m
telescopes
- Max. Base:
330m



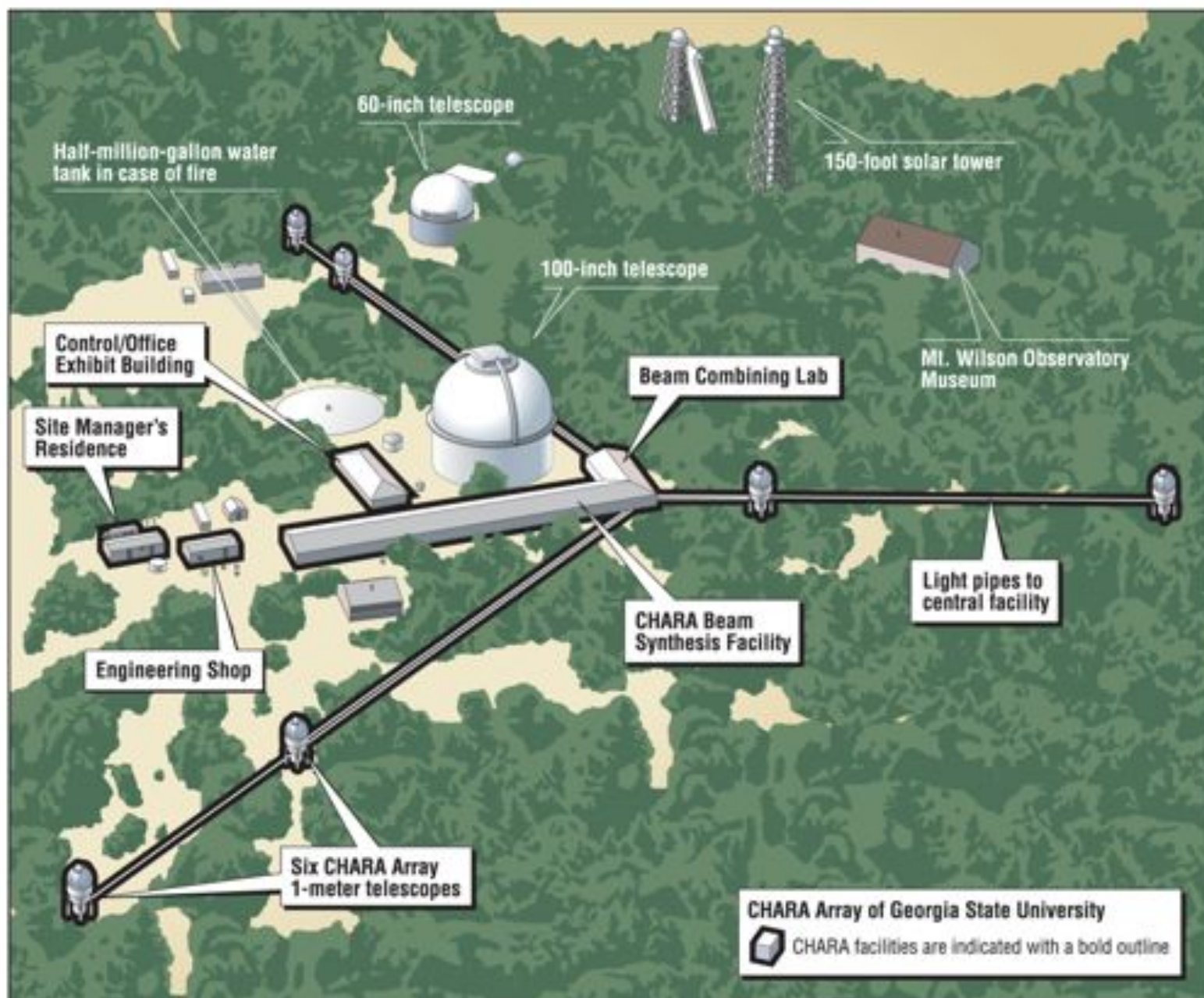

An introduction to optical/IR interferometry

- 6 Some examples of optical interferometers

Interferometry to-day is also:

Palomar
Testbed
Interferometer
(PTI)

- 3 x 40cm telescopes
- Max. Base: 110m



An introduction to optical/IR interferometry

- 6 Some examples of optical interferometers

Interferometry to-day

is also:

Keck
interferometer

- 2 x 10m
telescopes
- Base: 85m

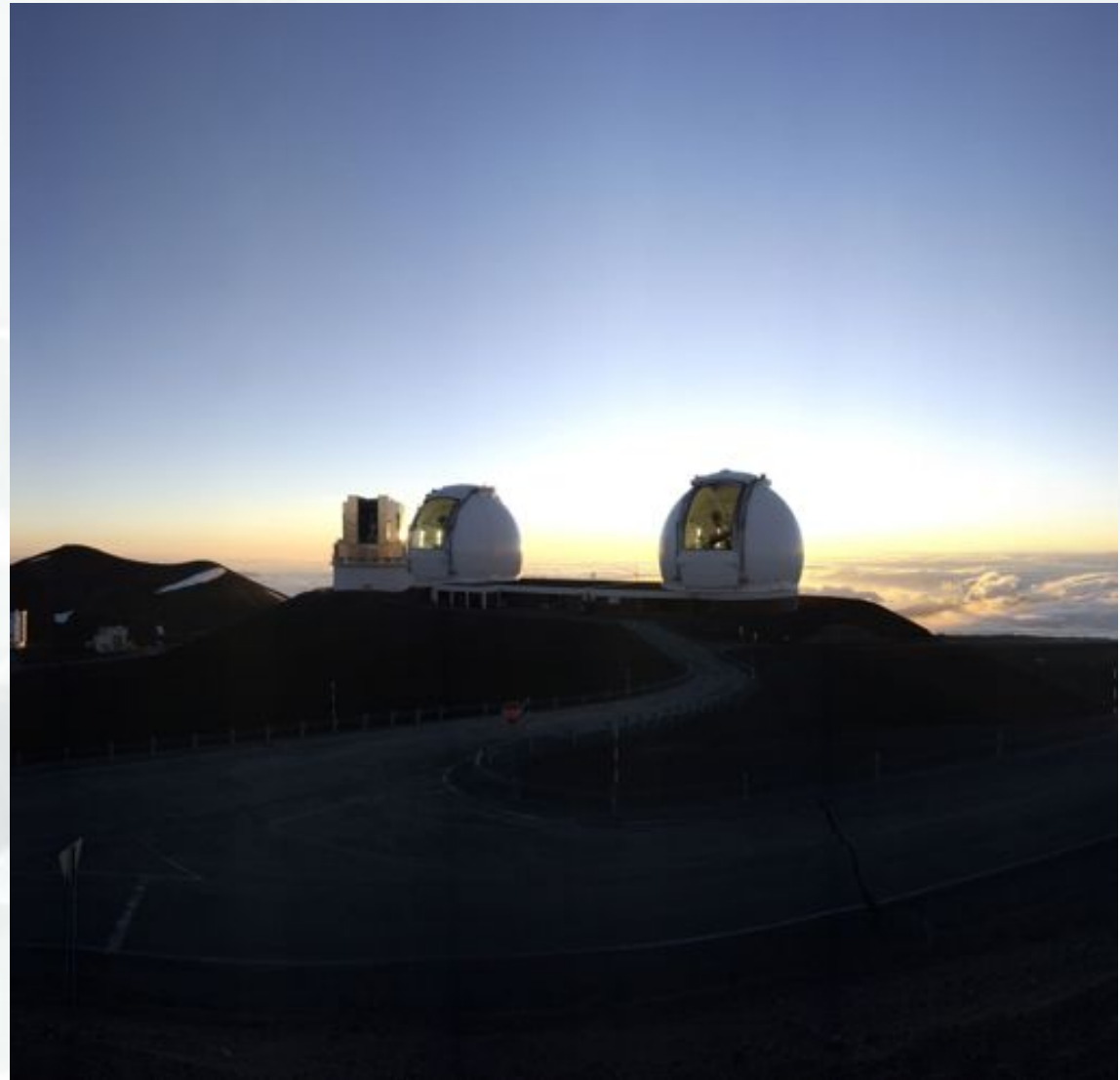



An introduction to optical/IR interferometry

■ 6 Some examples of optical interferometers

Interferometry to-day is also:

Nullin interferometry

- Measurement of « stellar leakage »
- Allow to resolve stars with a small size interferometer

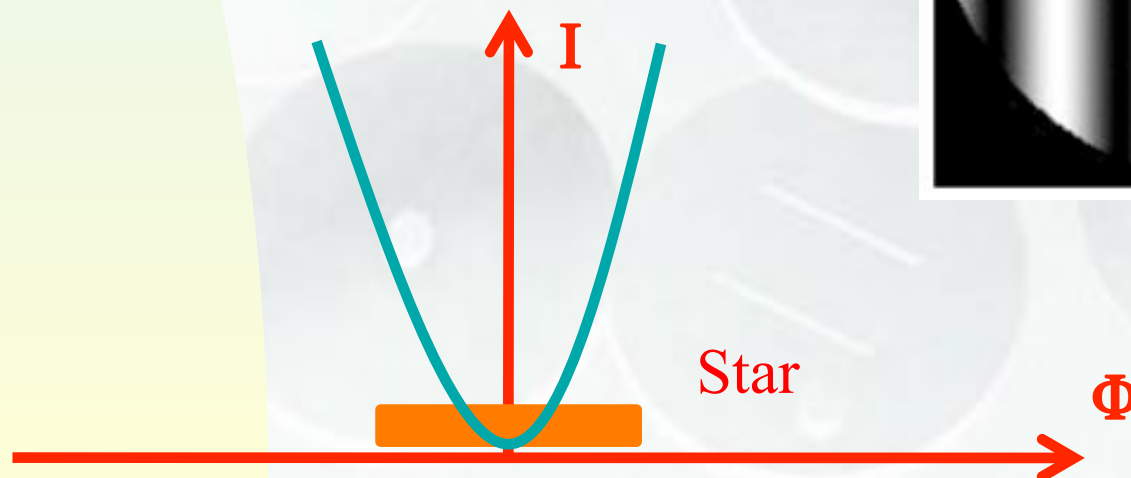
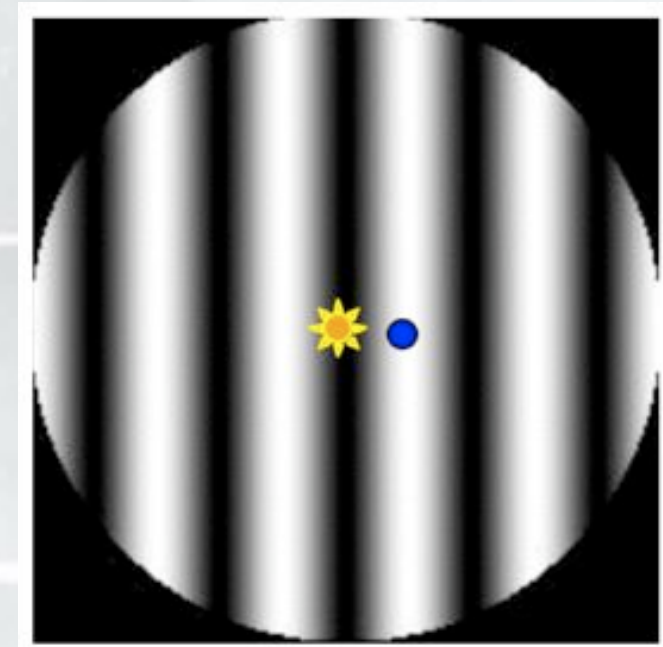

An introduction to optical/IR interferometry

- 6 Some examples of optical interferometers
- Interferometry to-day is also:**

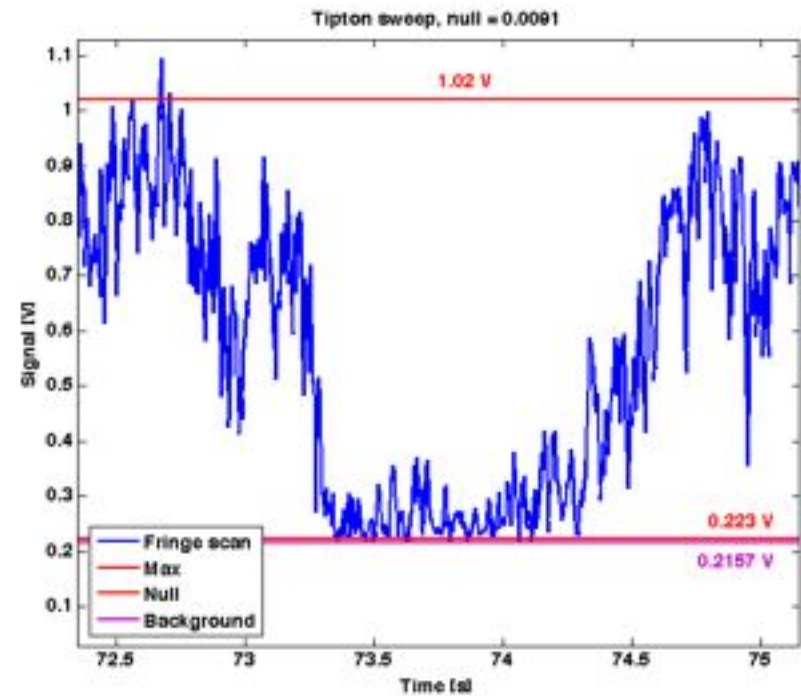
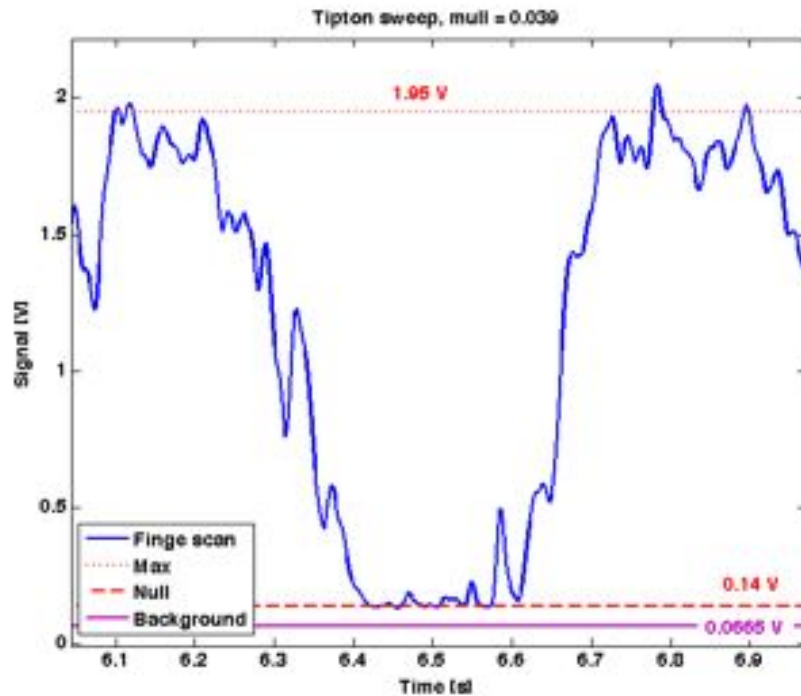

An introduction to optical/IR interferometry

- 6 Other examples of interferometers: ALMA



An introduction to optical/IR interferometry

- 6 Other examples of interferometers: DARWIN

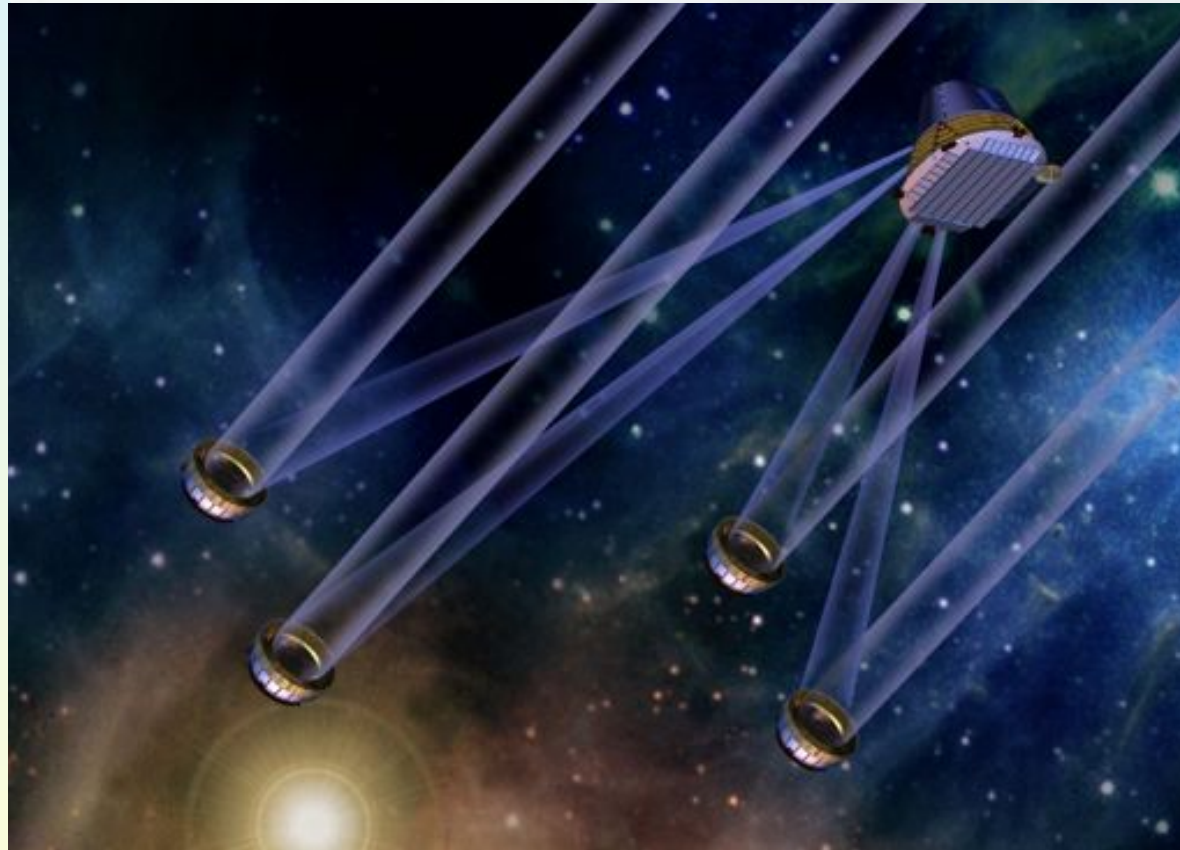

An introduction to optical/IR interferometry

- 7 Some results

Star	Spectral type	Luminosity class	Angular diameter $\times 10^{-3}$ seconds of arc
α Boo	K2	Giant	20
α Tau	K5	Giant	20
α Sco	M1-M2	Super-giant	40
β Peg	M2	Giant	21
σ Cet	M6e	Giant	47
α Ori	M1-M2	Super-giant variable	34→47

Table 2.1. Stars measured with Michelson's interferometer.
From Pease (1931).

An introduction to optical/IR interferometry

- 7 Some results

Table 2. Diamètres stellaires mesurés à l'IZT

NOM	SPECTRE	DIAMÈTRE $\lambda = 0,68 \mu\text{m}$ en ms. d'arc	MESURÉ $\lambda = 2,2 \mu\text{m}$ en ms. d'arc	R/R _☉	TEMPÉRATURE EFFECTIVE		DISTANCE en parsecs (1 pc = 3,26 al)
					$\lambda = 0,68 \mu\text{m}$ en degrés Kelvin	$\lambda = 2,2 \mu\text{m}$ en degrés Kelvin	
α Cas	K0III	$5,4 \pm 0,8$		26 ± 8	4700 ± 300		45 ± 9
β And	M0III	$13,3 \pm 1,7$	$14,4 \pm 0,8$	33 ± 9	3800 ± 380	3711 ± 84	23 ± 3
γ And	K3III	$6,8 \pm 0,8$		50 ± 14	4850 ± 250		75 ± 15
α Per	F8IV	$2,9 \pm 0,4$		55 ± 9	7000 ± 800		175 ± 9
α Cyg	A3Ie	$2,7 \pm 0,3$		145 ± 45	8200 ± 600		500 ± 100
α Ari	K2III	$7,6 \pm 1$		15 ± 5	4300 ± 350		23 ± 4
β Gem	K0III	$7,8 \pm 0,8$		8 ± 2	4800 ± 230		11 ± 1
β Umi	K4III	$5,9 \pm 1$		30 ± 9	4220 ± 300		31 ± 11
γ Ori	K5III	$8,7 \pm 0,8$	$10,2 \pm 1,4$	45 ± 10	4300 ± 230	3900 ± 270	59 ± 21
δ Ori	G8III	$3,8 \pm 0,3$		15 ± 5	4530 ± 220		36 ± 8
μ Gem	M3III		$14,6 \pm 0,8$	94 ± 30		3860 ± 95	60 ± 15
α Tau	K5III		$20,7 \pm 0,4$	47 ± 7		3904 ± 34	21 ± 3
α Boo	K2III		$21,5 \pm 1,2$	25 ± 6		4240 ± 120	11 ± 2
α Aur	G5III	$8,0 \pm 1,2$		$11,7 \pm 2$	5400 ± 200		$13,7 \pm 0,6$
α Aur _γ	G0III	$4,8 \pm 1,5$		$7,1 \pm 2$	5950 ± 200		$13,7 \pm 0,6$
α Lyr	A0V	$1,0 \pm 0,2$		$2,9 \pm 0,2$			$8,1 \pm 0,3$

An introduction to optical/IR interferometry

8 Three important theorems ... and some applications

8.1 The fundamental theorem

8.2 The convolution theorem

8.3 The Wiener-Khintchin theorem

Réf.: P. Léna; Astrophysique: méthodes physiques de l'observation (Savoirs Actuels / CNRS Editions)

An introduction to optical/IR interferometry

8.1 The fundamental theorem

$$a(p,q) = \text{TF}_-(A(x,y))(p,q),$$

$$a(p,q) = \int_{R^2} A(x,y) \exp[-i2\pi(px + qy)] dx dy,$$

with

$$p = x' / (\lambda f)$$

$$q = y' / (\lambda f)$$

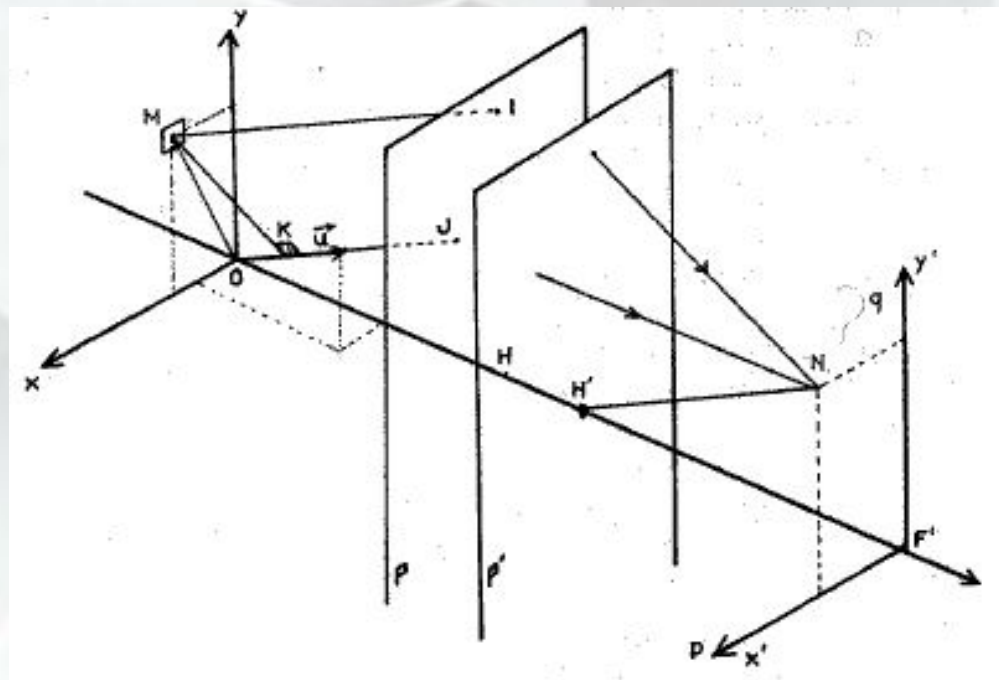

An introduction to optical/IR interferometry

8.1 The fundamental theorem

The distribution of the complex amplitude $a(p,q)$ in the focal plane is given by the Fourier transform of the distribution of the complex amplitude $A(x,y)$ in the entrance pupil plane.

An introduction to optical/IR interferometry

8.1 The fundamental theorem

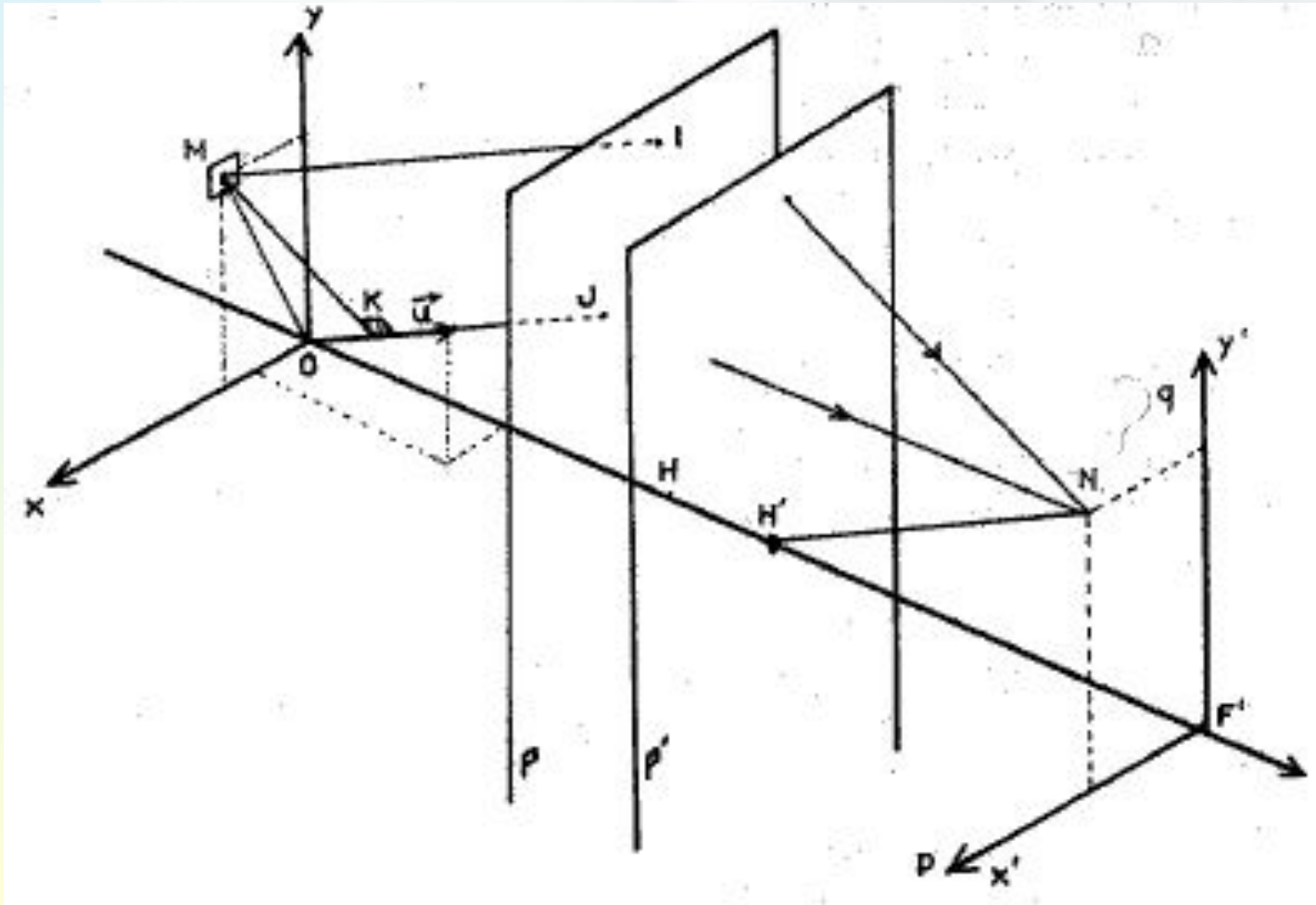

An introduction to optical/IR interferometry

8.1 The fundamental theorem

- **Démonstration**

$$A(x,y) \exp(i2\pi\nu t), \tag{8.1.3.1}$$

$$A(x,y) = A(x,y) \exp(i\phi(x,y)) P_0(x,y). \tag{8.1.3.2}$$

An introduction to optical/IR interferometry

8.1 The fundamental theorem

■ **Démonstration**

$$A(x,y) \exp(i2\pi vt + i\psi),$$

(8.1.3.3)

$$\delta = d(M | N) - d(O | N),$$

(8.1.3.4)

$$\psi = 2\pi \delta / \lambda.$$

(8.1.3.5)

An introduction to optical/IR interferometry

8.1 The fundamental theorem

■ Démonstration

$$\delta = -d(O, K) = -|(\mathbf{OM} \mathbf{u})|, \quad (8.1.3.6)$$

$$A(x,y) \exp(i2\pi(\nu t - xx'/\lambda f - yy'/\lambda f)). \quad (8.1.3.7)$$

$$\rho = x'/\lambda f, \quad q = y'/\lambda f, \quad (8.1.3.8)$$

$$\exp(i2\pi\nu t) A(x,y) \exp(-i2\pi(x\rho + yq)). \quad (8.1.3.9)$$

An introduction to optical/IR interferometry

8.1 The fundamental theorem

■ **Démonstration**

$$a(p, q) = \int_{R^2} A(x, y) \exp[-i2\pi(px + qy)] dx dy, \quad (8.1.3.10)$$

$$a(p, q) = TF_{-}[A(x, y)](p, q) \quad (8.1.3.11)$$

An introduction to optical/IR interferometry

8.1 The fundamental theorem

Application: Point Spread Function determination

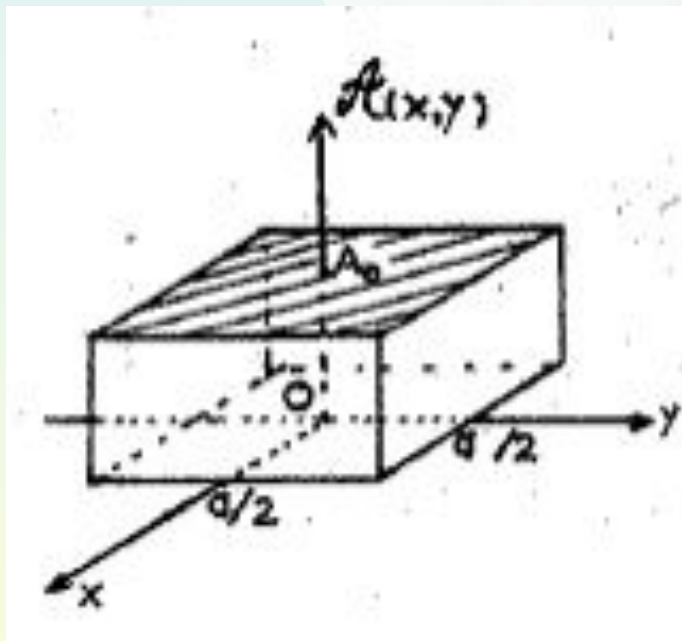

$$A(x,y) = A_0 P_0(x,y), \quad (8.1.1)$$

$$P_0(x,y) = \Pi(x/a) \Pi(y/a). \quad (8.1.2)$$

An introduction to optical/IR interferometry

8.1 The fundamental theorem

$$a(p, q) = TF [A(x, y)](p, q) = \int_{-a/2}^{a/2} \int_{-a/2}^{a/2} A_0 \exp[-i2\pi(px + qy)] dx dy \quad (8.1.3)$$

$$a(p, q) = A_0 \int_{-a/2}^{a/2} \exp[-i2\pi px] dx \int_{-a/2}^{a/2} \exp[-i2\pi qy] dy \quad (8.1.4)$$

$$a(p, q) = A_0 a^2 [\sin(\pi pa) / (\pi pa)] [\sin(\pi qa) / (\pi qa)]. \quad (8.1.5)$$

$$\begin{aligned} i(p, q) &= a(p, q) a^*(p, q) = |a(p, q)|^2 = |h(p, q)|^2 = \\ &= i_0 a^4 [\sin(\pi pa) / (\pi pa)]^2 [\sin(\pi qa) / (\pi qa)]^2. \end{aligned} \quad (8.1.6)$$

An introduction to optical/IR interferometry

8.1 The fundamental theorem

Application: Point Spread Function determination

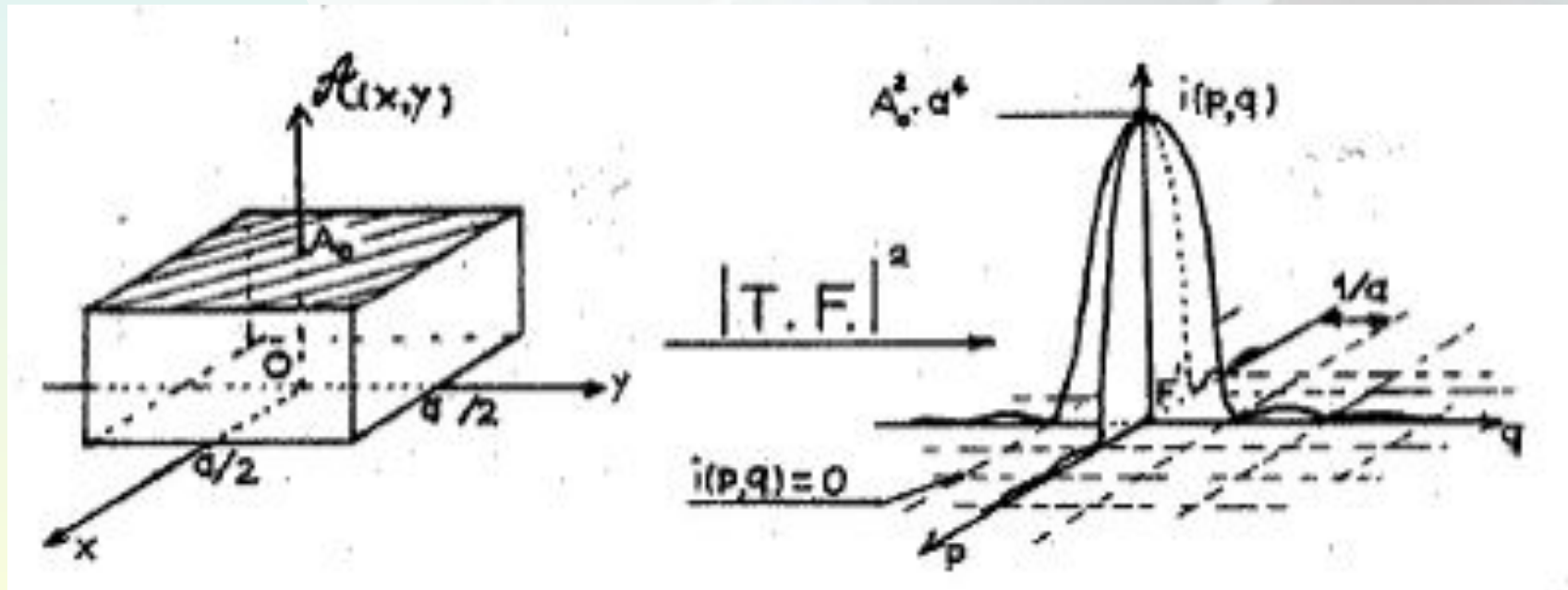

$$\Delta p = \Delta x' / (\lambda f); \Delta q = \Delta y' / (\lambda f) = 2/a \rightarrow \Delta \phi_x = \Delta \phi_y = 2\lambda/a \quad (8.1.7)$$

An introduction to optical/IR interferometry

8.1 The fundamental theorem

Application: Point Spread Function determination when observing a star along another direction

$$\psi = 2\pi \delta / \lambda = 2\pi(xb/f + yc/f) / \lambda, \quad (8.1.5.7)$$

$$A(x,y) = P_0(x,y) A_0 \exp[2i\pi(xb/f + yc/f) / \lambda]. \quad (8.1.5.8)$$

$$a(p,q) = A_0 \int_{-a/2}^{a/2} \exp[-2i\pi(p - b/f\lambda)x] dx \int_{-a/2}^{a/2} \exp[-2i\pi(q - c/f\lambda)y] dy \quad (8.1.5.9)$$

$$a(p,q) = A_0 a^2 \left(\frac{\sin(\pi(p - b/f\lambda)a)}{\pi(p - b/f\lambda)a} \right) \left(\frac{\sin(\pi(q - c/f\lambda)a)}{\pi(q - c/f\lambda)a} \right) \quad (8.1.5.10)$$

An introduction to optical/IR inter

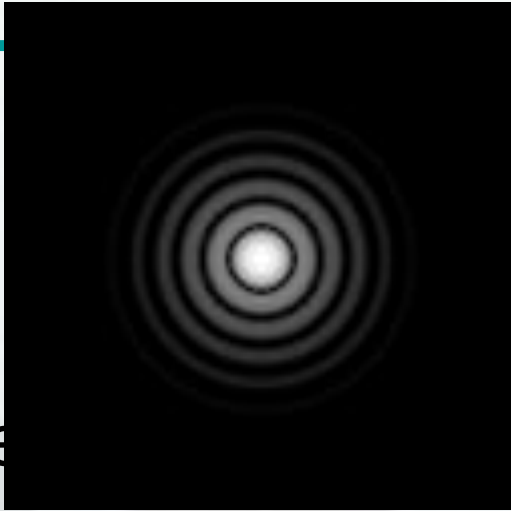

8.1 The fundamental theorem

Application: Point Spread Function dete

$$h(p,q) = \text{TF}_-(P(x,y))(p,q)$$

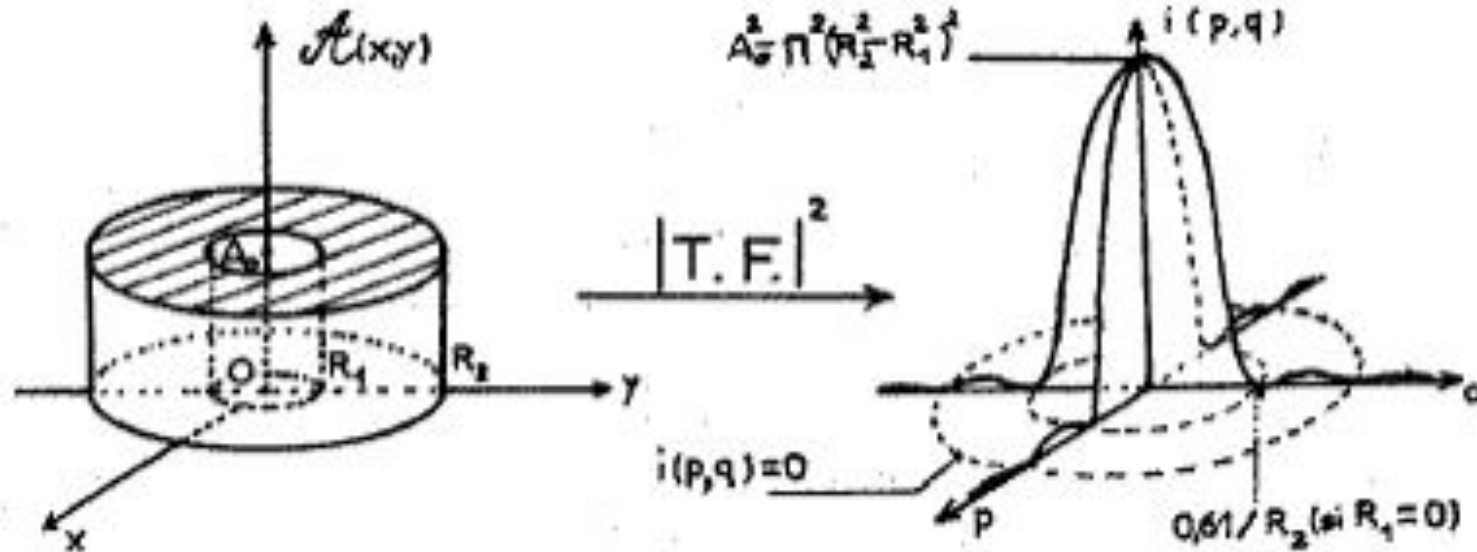

$$i(\rho') = |a(\rho')|^2 = (A_0 \pi)^2 [R_2^2 \frac{2 J_1(Z_2)}{Z_2} - R_1^2 \frac{2 J_1(Z_1)}{Z_1}]^2, \quad (8.1.8)$$

$$\text{with } Z_2 = 2\pi R_2 \rho' / (\lambda f) \text{ and } Z_1 = 2\pi R_1 \rho' / (\lambda f). \quad (8.1.9)$$

An introduction to optical/IR interferometry

■ BESSEL FUNCTIONS (REMINDER)

Integral representation of the Bessel functions

$$J_0(x) = \frac{1}{\pi} \int_0^\pi \cos[x \sin(\vartheta)] d\vartheta$$

$$J_n(x) = \frac{1}{\pi} \int_0^\pi \cos[n\vartheta - x \sin(\vartheta)] d\vartheta$$

Undefined integral

$$\int x' J_0(x') dx' = x J_1(x)$$

Series development ($x \sim 0$):

$$J_0(x) = 1 - x^2/2^2 + x^4/(2^2 4^2) - x^6/(2^2 4^2 6^2) + \dots$$

$$J_1(x) = x/2 - x^3/(2^2 4) + x^5/(2^2 4^2 6) - x^7/(2^2 4^2 6^2 8) + \dots$$

$$J_n(x) = (2 / (\pi x))^{1/2} \cos(x - n\pi/2 - \pi/4) \dots \text{ and when } x \text{ is large!}$$

Graphs of the $J_0(x)$ and $J_1(x)$ functions

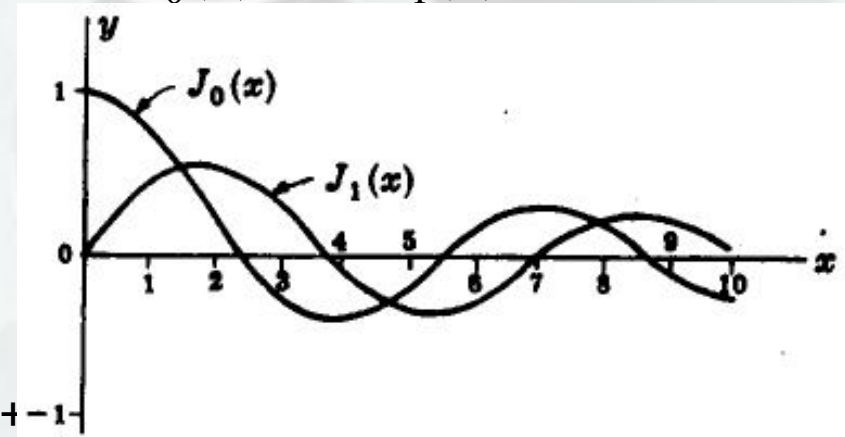

An introduction to optical/IR interferometry

8.1 The fundamental theorem

Application: Point Spread Function determination

$$x = \rho \cos(\theta), y = \rho \sin(\theta), p = \rho' \cos(\theta') / (\lambda f), q = \rho' \sin(\theta') / (\lambda f).$$

(8.1.5.13)

$$a(\rho', \theta') = A_0 \int_{R_1}^{R_2} \int_0^{2\pi} \exp\left[-2i\pi\rho\rho' \cos(\theta - \theta') / (\lambda f)\right] d(\theta - \theta') \rho d\rho$$

(8.1.5.14)

$$a(\rho', \theta') = a(\rho') = A_0 \pi \left[\frac{2R_2^2}{Z_2} J_1(Z_2) - \frac{2R_1^2}{Z_1} J_1(Z_1) \right]$$

(8.1.5.15)

$$Z_2 = 2\pi R_2 \frac{\rho'}{\lambda f} \quad \text{et} \quad Z_1 = 2\pi R_1 \frac{\rho'}{\lambda f}$$

(8.1.5.16)

$$\text{Pour le cas } R_1 = 0 \quad i(\rho') = |a(\rho')|^2 = 4(A_0\pi)^2 R_2^4 \left(\frac{J_1(Z_2)}{Z_2} \right)^2$$

(8.1.5.17)

An introduction to optical/IR inter

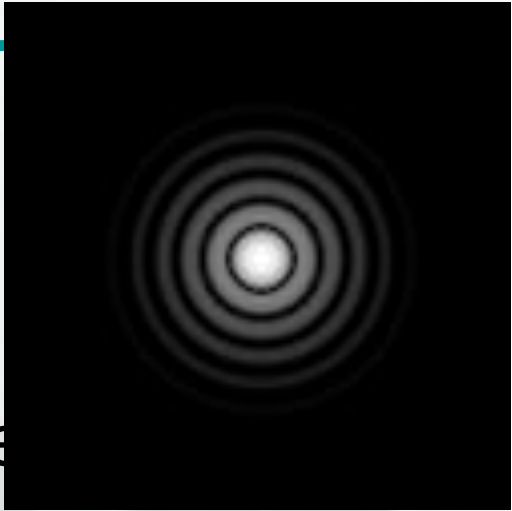

8.1 The fundamental theorem

Application: Point Spread Function dete

$$h(p,q) = \text{TF}_-(P(x,y))(p,q)$$

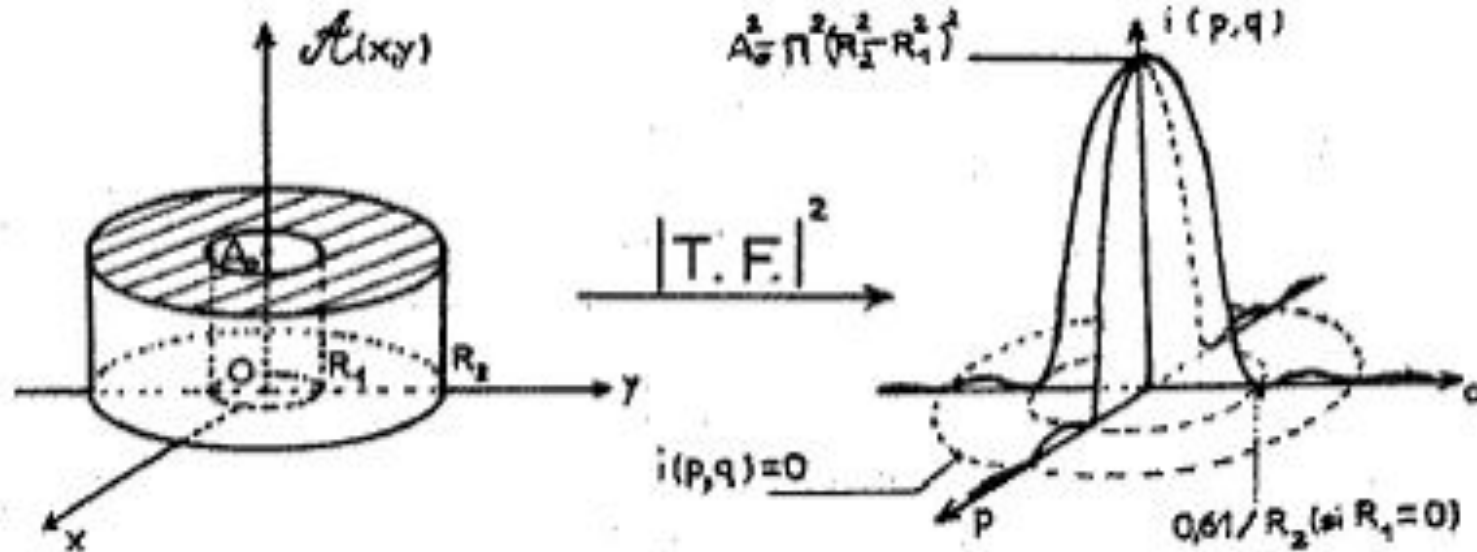

$$i(\rho') = |a(\rho')|^2 = (A_0 \pi)^2 [R_2^2 \frac{2 J_1(Z_2)}{Z_2} - R_1^2 \frac{2 J_1(Z_1)}{Z_1}]^2, \quad (8.1.8)$$

$$\text{with } Z_2 = 2\pi R_2 \rho' / (\lambda f) \text{ and } Z_1 = 2\pi R_1 \rho' / (\lambda f). \quad (8.1.9)$$

An introduction to optical/IR interferometry

8.1 The fundamental theorem

Application: Point Spread Function determination

$$\rho' (=r) = 1,22 \lambda f / D \quad (D = 2 R_2, R_1 = 0). \quad (8.1.5.18)$$

$$\frac{2\pi \int_0^r i(\rho') \rho' d\rho'}{2\pi \int_0^\infty i(\rho') \rho' d\rho'} = 0,84 \quad (8.1.5.19)$$

$$h(p,q) = \text{TF}_-(P(x,y))(p,q). \quad (8.1.5.20)$$