



---

DEA THESIS

Louvigny Yannick

# Preliminary design of twin-cylinder engines

Supervisor: Professor P. Duysinx

Academic year 2007-2008

August 2008

This thesis is submitted in partial fulfillment of the requirements for the Degree of Advanced Studies in Applied Sciences

# Abstract

This report deals with the preliminary design of a twin-cylinder engine. The goal of the work is not to make the detailed design of the engine but to draw the main characteristics of each kind of engine and to investigate which configuration of twin-cylinder engine matches in the best way to given requirements.

A simple model is developed from the motion equations of the rotating and oscillating parts of piston engine. This model allows calculating the values of the inertia forces and moments for each angular position of the crankshaft. Different configurations of single-cylinder and twin-cylinder engines (including in-line or boxer, in-phase or out-of-phase motion of the piston) are considered. All of these configurations are characterized by their own set of forces and moments.

As the free forces and moments are responsible for engine vibrations and thus vibrations of the vehicle and its passengers, a set of balancing solutions (modification of the crankshaft, addition of first or second order balance shafts) is considered to reduce these loads. This is the balancing of the engine. Great reductions of forces and moments can be obtained with more or less complex solutions. From a design point of view, the next step is to determine what level of vibration is acceptable and which solutions permit to reach this level. A model of a classical four-cylinder engine is made in order to serve as a reference for the comparison of the different configurations of twin-cylinder engine.

In addition to the inertia forces, the combustion of the fuel inside the cylinder produces also forces and moments in the engine. To estimate the total forces and moments created by the engine, the gas pressure force is calculated for each configuration of the engine.

The last step of this preliminary design consists in investigating the influence of design parameters that can impact the balancing of the engine. A sensitivity analysis is made with different design parameters of the engine (i.e. the mass of the piston, the mass and length of the connecting rod...) This analysis permits to know, depending of the configuration of the engine, which characteristics will require a greater attention during the design phases.

# Acknowledgement

First of all, I would like to express my gratitude to my supervisors, Professors Pierre Duysinx and Jean-Luc Bozet for giving me the opportunity to write this report and to work with them during these two years.

I wish also to thank Mr. Ernst Breuer, manager of BTM, who is the instigator of this project, for the time and the data, he shared with us.

I would like to thank Professor André Jamoulle for his knowledge and his precious advices.

Finally, I would like to express my gratitude to Cendrine and to my Family for their presence and support all these years.

# Table of contents

Abstract .....	2
Acknowledgement.....	3
Table of contents .....	4
1. Introduction and objectives .....	6
2. Literature review .....	8
3. Modeling of engines.....	11
3.1. Engine and crankshaft configurations .....	11
3.1.1. Engines .....	11
3.1.2. Crankshaft .....	12
3.1.3. Strokes.....	14
3.1.4. Balance shafts.....	15
3.2. Modeling .....	16
3.2.1. Coordinate system .....	16
3.2.2. Assumptions .....	17
3.2.3. Equations.....	18
4. Evaluation and balance of inertia forces .....	23
4.1. Approximation of equations.....	23
4.2. Shorter stroke single-cylinder engine.....	24
4.2.1. Reference data (case 1) .....	24
4.2.2. Optimization of the crankshaft (case 2) .....	28
4.2.3. Balance shafts.....	31
4.2.4. Summary .....	40
4.3. Longer stroke single-cylinder engine.....	42
4.4. Shorter stroke twin-cylinder in-line engine, in-phase arrangement .....	44
4.4.1. Reference data (case 1) .....	44
4.4.2. Optimization of the crankshaft (case 2) .....	45
4.4.3. Balance shafts.....	47
4.4.4. Summary .....	51
4.5. Longer stroke twin-cylinder in-line engine, in-phase arrangement .....	53
4.6. Shorter stroke twin-cylinder in-line engine, out-of-phase arrangement .....	55
4.6.1. Reference data (case 1) .....	55
4.6.2. Optimization of the crankshaft (case 2) .....	56
4.6.3. Balance shafts.....	58
4.6.4. Summary .....	60
4.7. Longer stroke twin-cylinder in-line engine, out-of-phase arrangement.....	62
4.8. Shorter stroke twin-cylinder boxer engine, out-of-phase arrangement.....	64
4.8.1. Reference data (case 1) .....	64
4.8.2. Optimized crank and balance shafts.....	64
4.8.3. Summary .....	65
4.9. Longer stroke twin-cylinder boxer engine, out-of-phase arrangement .....	67
4.10. Shorter stroke twin-cylinder boxer engine, in-phase arrangement .....	69
4.11. Longer stroke twin-cylinder boxer engine, in-phase arrangement.....	71
5. Effect of the gas pressure .....	73
5.1. Single-cylinder engine.....	73
5.2. In-line twin-cylinder in-phase engine .....	77
5.2.1. Shorter stroke .....	77
5.2.2. Longer stroke.....	81

5.3.	In-line twin-cylinder out-of-phase engine.....	83
5.3.1.	Shorter stroke .....	83
5.3.2.	Longer stroke.....	85
5.4.	Boxer twin-cylinder out-of-phase engine.....	86
5.4.1.	Shorter stroke .....	86
5.4.2.	Longer stroke.....	87
5.5.	Boxer twin-cylinder in-phase engine .....	87
5.5.1.	Shorter stroke .....	87
5.5.2.	Longer stroke.....	87
6.	Comparison of twin-cylinder engines .....	88
6.1.	Vibration point of view .....	88
6.1.1.	Comparison of different twin-cylinder arrangements .....	88
6.1.2.	Comparison with a four-cylinder engine.....	90
6.2.	Gas pressure effect point of view .....	94
7.	Sensitivity analysis.....	96
7.1.	Mass of the piston .....	96
7.1.1.	In-phase in-line twin-cylinder engine .....	96
7.1.2.	Out-of-phase in-line twin-cylinder engine .....	98
7.1.3.	Out-of-phase twin-cylinder boxer engine .....	99
7.1.4.	In-phase twin-cylinder boxer engine.....	100
7.2.	Mass of the connecting rod .....	101
7.2.1.	In-phase in-line twin-cylinder engine .....	101
7.2.2.	Out-of-phase in-line twin-cylinder engine .....	103
7.2.3.	Out-of-phase twin-cylinder boxer engine .....	104
7.2.4.	In-phase twin-cylinder boxer engine.....	105
7.3.	Length of the connecting rod .....	106
7.3.1.	In-phase in-line twin-cylinder engine .....	106
7.3.2.	Out-of-phase in-line twin-cylinder engine .....	108
7.3.3.	Out-of-phase twin-cylinder boxer engine .....	109
7.3.4.	In-phase twin-cylinder boxer engine.....	110
7.4.	Distance between bore centers .....	111
7.4.1.	In-phase in-line twin-cylinder engine .....	111
7.4.2.	Out-of-phase in-line twin-cylinder engine .....	112
7.4.3.	Out-of-phase twin-cylinder boxer engine .....	113
7.4.4.	In-phase twin-cylinder boxer engine.....	114
7.5.	Conclusions .....	115
8.	Conclusions .....	116
	References .....	121
	Appendix .....	123
	Appendix A: Graphics of forces and moments for the different configurations of twin-cylinder engine .....	123
	Appendix B: Graphics of forces and moments for the four-cylinder engine .....	160

# 1. Introduction and objectives

“The climate is changing”. “Pollution produced by human activities endangers the equilibrium of the planet”. Facing environmental and energy resources depletion challenges, automotive industry has to improve the fuel economy of new vehicles and reduce their polluting emissions. Transport of goods and people is an important source of CO<sub>2</sub> emissions. In particular, passenger cars that are widespread in our modern countries are responsible for an important amount of CO<sub>2</sub> and pollutants. To reduce pollution from those cars, there are two major solutions: a more rational use of the vehicle (carpooling...) and making cleaner cars.

To make cleaner vehicle, a strategy that is widely used nowadays is the *downsizing* i.e. replacing a big engine by a smaller one with a higher specific power. This has become possible thanks to turbochargers and direct injection. This tendency will be particularly reinforced with hybrid electric cars.

With the high specific power (horsepower per liter of engine displacement) achieved nowadays in common cars (more than 100 hp/l for gasoline or 85 hp/l for diesel), small twin-cylinder engines regain interests for use in urban cars and as prime movers in hybrid electric cars. The twin-cylinder has the advantage of needing fewer parts than a four-cylinder of the same displacement and thus being less expensive [HEISLER 1999]. Moreover some parts (piston, connecting rod, valve...) can be common with some four or six cylinders engines of the same line. Reducing the number of cylinders sounds also more interesting than reducing the volume of cylinders because of the more delicate design of small cylinders. On the other hand, the difficulty with engine having few cylinders (three or less) comes from the balancing of the engine.

A perfectly balanced engine is one in which the relative motion of the component parts do not set up an accumulation of forces that tends to make the engine shake and rock. Hence, if the perfectly balance engine were to be suspended freely in space, no vibration or other movement would be observed. Therefore, in theory, such an engine could be attached directly to its support frame. Conversely, a partially balanced engine requires some sort of suspension mounting to isolate the engine from its support frame to prevent any of the unbalanced reaction movement being transmitted through to the vehicle's chassis and body [HEISLER 1995].

So, the main goal of this study is to investigate the preliminary design of a twin-cylinder engine. This work is made in cooperation with BTD (Breuer technical development). BTD is one of Belgium's leading developers of modern engines, including both high-performance competition engines and series production engines [BTD 2008]. BTD has provided the technical data of the engine (geometry of the cylinder parts, pressure inside the cylinder...). The different steps and intermediate objectives of this work are:

- Considering and comparing different configurations of twin-cylinder engine to emphasize the advantages and drawbacks of each ones. The differences between these configurations include the relative position of the cylinders (in-line or opposed), the shape of the crankshaft (in-phase or out-of-phase).
- Computing the forces and moments inside the engines. The calculations are based on simplified models of the engines developed from the equations of motion of uncoupled rigid pistons.

- Balancing the engines. This is made by using different methods alone or in conjunction. These methods are namely the optimization of the crankshaft counterweights, the addition of one or two first or second order balance shafts.
- Introducing in the simulation the effect of the gas pressure inside the cylinder. This allows calculating the forces and moments due to the combustion, their effect on the balancing of the engine and the engine torque (instantaneous and average).
- Comparing the different twin-cylinder configurations with a classical four-cylinder engine in order to determine which configuration offers an equivalent comfort in terms of vibration but remains simple enough from a design point of view.
- Studying the influence of the stroke on the forces and moments generated by the engine. Two different strokes are included in the engine arrangements.
- Making a sensitivity analysis on the design parameters (i.e. mass of the piston, mass and length of the connecting rod and distance between the bore centers) in order to determine the most interesting parameters to modify to improve the balancing of the engine.

At the end of this approach, we would be able to provide guidelines to help designers to determine which configuration of twin-cylinder engine is adapted for their specific application. And we would know which parameters will be critical in the engine conception.

## 2.Literature review

New legislation and environmental considerations have pushed the car companies to improve the efficiency, and thus the specific power of their engines. Thanks to the high specific power reached nowadays by modern engines (gasoline or diesel), very small engines (displacements smaller than 1000 cc) are powerful enough to be operated in small urban cars or used as prime movers in hybrid cars. To build so small engines, there are two choices possible: using a traditional four-cylinder arrangement with small size cylinders or using fewer cylinders (two or three cylinders).

Reducing the volume of each cylinder is a hard task because the design of small mobile parts is very difficult and the efficiency becomes smaller (the friction to power ratio is increasing). Moreover, an engine with few cylinders has the advantage of needing fewer parts than a four-cylinder of the same displacement so it will be easier to build, to maintain and to repair. It will also be less expensive and shorter [HEISLER 1999]. On the other hand, the difficulty with engine having three or less cylinders comes from its balancing. Today, many car manufacturers are developing small engines with two or three cylinders:

Volkswagen [VW 2008] uses a gasoline three-cylinder engine (1198 cc offering different choices of power: 40 kW, 44 kW and 51 kW) or a diesel three-cylinders engine (1422 cc, 51 kW or 59 kW) in the smallest cars of the VW company (VW Fox, VW Polo, Seat Ibiza, Skoda Fabia...).

Hyundai [HYUNDAI 2008] introduces a three-cylinder diesel engine (1120 cc, 55 kW) in the Hyundai I10 (this engine is also mounted in the Kia Picanto).

Toyota [TOYOTA 2008] offers a three-cylinder gasoline engine (998 cc, 50kW) in the Toyota Aygo, Yaris and probably in the future Toyota IQ (this engine is also mounted in the Peugeot 107 and Citroen C1).

Daihatsu [DAIHATSU 2008], the specialist of the urban cars, offers a three-cylinder gasoline engine (989 cc, 43 kW) in the Daihatsu Trevis. While the Daihatsu Sirion and Cuore use the Toyota three-cylinder gasoline engine (998 cc, 50kW).

Opel [OPEL 2008] makes also a three-cylinder gasoline engine (998cc, 44kW) in the Opel Corsa and Agila.

And last but not least, the Smart [SMART 2008], built by Daimler, uses a complete range of three-cylinder engines, from diesel engine (799 cc, 33 kW) to gasoline engines without turbo compressor (999 cc, 45 kW or 52 kW) or equipped with a turbo compressor (999 cc, 62 kW or 72 kW).

Nevertheless, these two-cylinder or three-cylinder engines are not naturally balanced. So, in a basic configuration, they are noisier and more vibrating than an equivalent four-cylinder engine. Today, ride comfort and noise cancellation are crucial in the automotive industry. Even the most basic and low-cost cars of a manufacturer range have to be comfortable and well equipped. So the balancing of these small engines is at the center of the car manufacturers researches.



The basic notions for the calculation of the inertia forces and for the balancing of the more classical configurations of engine are well-known for a long time and are described in different reference textbooks [MAASS 1981, HEISLER 1995, BOSCH 2000]. But the subject is still studied nowadays, in particular, the more specific arrangements (boxer engine, Vee-engine with unusual angle between cylinder rows).

Grigoryev, Vasilyev and Dolgov [GRIGORYEV 2006, VASILYEV 2007] develop a method to determine which arrangement (vee-angle, shape of the crankshaft...) of a given engine gives the minimum mass and vibrations of the engine.

But these models only take into account the piston primary motion (longitudinal motion). The secondary motions of the piston (lateral and rotational motion) are neglected. In practice, due to a small clearance between the piston and the cylinder wall, there are always lateral and rotational motions of the piston. There is a side thrust force induced by the connecting rod and the direction of this force changes periodically. So the piston moves from one side to the opposite side of the cylinder wall and collides with it. This phenomenon is called “piston slap” and is responsible for unwanted noise and vibration. Cho et al. [CHO 2002] develop a simple model to estimate the impact force induced by the piston slap. To validate their model, they compare the numerical results with measured vibration responses, the model gives good predictions below 500 Hz but there are some discordances above 500 Hz.

Engine vibrations are not only due to the inertia forces, the fuel combustion inside the cylinders is also responsible for vibrations and noises. In particular, if the combustion is unequal in the different cylinders, the individual torque produced by each cylinder will be different and that will produce torsional vibrations of the crankshaft and risk of breakdown. Östman and Toivonen [ÖSTMAN 2008] suggest a method to reduce these torsional vibrations. The method uses the angular speed sensor of the crankshaft to detect unbalance torque distribution. The angular acceleration of the crankshaft allows calculating the net torque produced by each cylinder. The variations of torque are corrected by adjustment of the fuel injection in the right cylinders. The technique is tested on a real engine and a 90 % reduction of the amplitude of the torsional vibrations is achieved.

Chauvin et al. [CHAUVIN 2006] make the same kind of unbalance torque distribution measurements. In the first part of their study, they present also a method based on the crankshaft angular speed. But in the second part, they measure the air fuel ratio injected in each cylinder to control the combustion torque.

It appears that one of the most important components of the engine is the crankshaft. Of course, it is one of the components that transform the linear motion of the pistons into a rotational motion. But it is also used to carry the counterweights that balance a part of the inertia forces and moments. So to achieve a very small vibration level, a careful attention has to be accorded to the design of the crankshaft. That is the reason why there are still so much scientific studies dedicated to the crankshaft and its influence on the balancing of the engine.

Zouroufi and Fatemi [ZOUROUFI 2005] present a literature review on fatigue performance evaluation and comparisons of different manufacturing procedures of crankshaft. The crankshaft specifications, operating conditions and sources of failures are first reviewed, then the design and the manufacturing procedures of the crankshafts are discussed. Geometric optimization and cost analysis are also briefly presented.

Bayrakçeken et al. [BAYRAKÇEKEN 2007] study the failure causes of several crankshafts of single-cylinder diesel engines.

The next step consists in building a complete model of the engine including the crankshaft and all the mobile parts to study the dynamic and the vibrations of the engine. Boysal and Rahnejat [BOYSAL 1997] make a multi-body numerical nonlinear dynamic model of a single cylinder engine. The model includes a piston, connecting rod, crankshaft, flywheel, timing gear, torsional damper and crankshaft main journal bearings. The model is parameterized to allow testing of different designs. The results obtained provide dynamic response of all parts, torsional vibrations of the crankshaft and whirls of journal bearings. The numerical solutions agree with analytical solutions and experimental tests.

Mourelatos [MOURELATOS 2001] takes an interest in the same problem. He does a complete engine model that couples the crankshaft dynamics, the main bearings hydrodynamic lubrication and the engine block stiffness. The method is applied to a five-cylinder in-line engine. Computed vibrations of the crankshaft are compared with measured response and the correlation is very good. A V6 engine is also simulated in order to demonstrate the methodology capability to fit to different configurations.

Metallidis and Natsiavas [METALLIDIS 2003] present models of single-cylinder and multi-cylinder engines that take into account the dependence of the engine moment of inertia on the crankshaft rotation. The driving and the resisting torques depend also on the crankshaft rotation that leads to dynamic models with non-linear equations of motion. First, an analytical solution is searched for a linearized version of the equations, and then numerical results are given for linear and non-linear models. And finally, response of the system in case of engine misfire is investigated.

The balancing of the engine is never perfect, so it remains always some unwanted vibrations. Then, another important task is to minimize the vibrations that are transmitted from the engine to the rest of the vehicle. That is one function of the engine mounts.

Snyman et al. [SNYMAN 1995] study the minimization of the transmission of engine vibration in the case of a mounted four-cylinder engine. This is an optimization problem and the minimization of the motion at the mounting position is the objective function. The position and the phase angle of some balancing masses are the design variable. The authors apply Snyman's dynamic optimization algorithm (LFOP1B) successfully to this problem.

Foumani et al. [FOUMANI 2003] develop an experimental/numerical technique for engine mounts optimization. Their method is based on experimental results and does not require complicated mathematical models of the vehicle. They use only a quarter car model composed of three subsystems (chassis, mount and engine). The mount is the part to be optimized, the engine is assumed rigid and its inertia is known, and the response of the chassis is deduced from experiments

All these works and studies illustrate that actual car designers worry about minimizing noise and vibrations in modern car. For this purpose, the boxer engine shows real interests because its inertia forces are naturally balanced.

## 3. Modeling of engines

We describe in this section the different configurations of engines, crankshafts, strokes and balance shafts that are considered in this report. We also describe the set of axes, the models and establish the motion equations we use.

### 3.1. Engine and crankshaft configurations

#### 3.1.1. Engines

We focus on two different types of engine: in-line engine and boxer engine.

In the *in-line engine*, also designated as straight engine, cylinders are arranged consecutively in one row (figure 1). This is by far the most common configuration used for three, four and five cylinders engine mounted in small and medium-size cars. The reasons are that in-line engines are considerably easier to build than any other equivalent engine arrangements because the cylinder bank can be milled from a single metal casting and require fewer cylinder heads and camshafts [WIKIPEDIA 2007]. Moreover, it can be mounted in different directions, lengthways or transversely, and could accept an inclination, which is important for small engine bay and safety considerations.

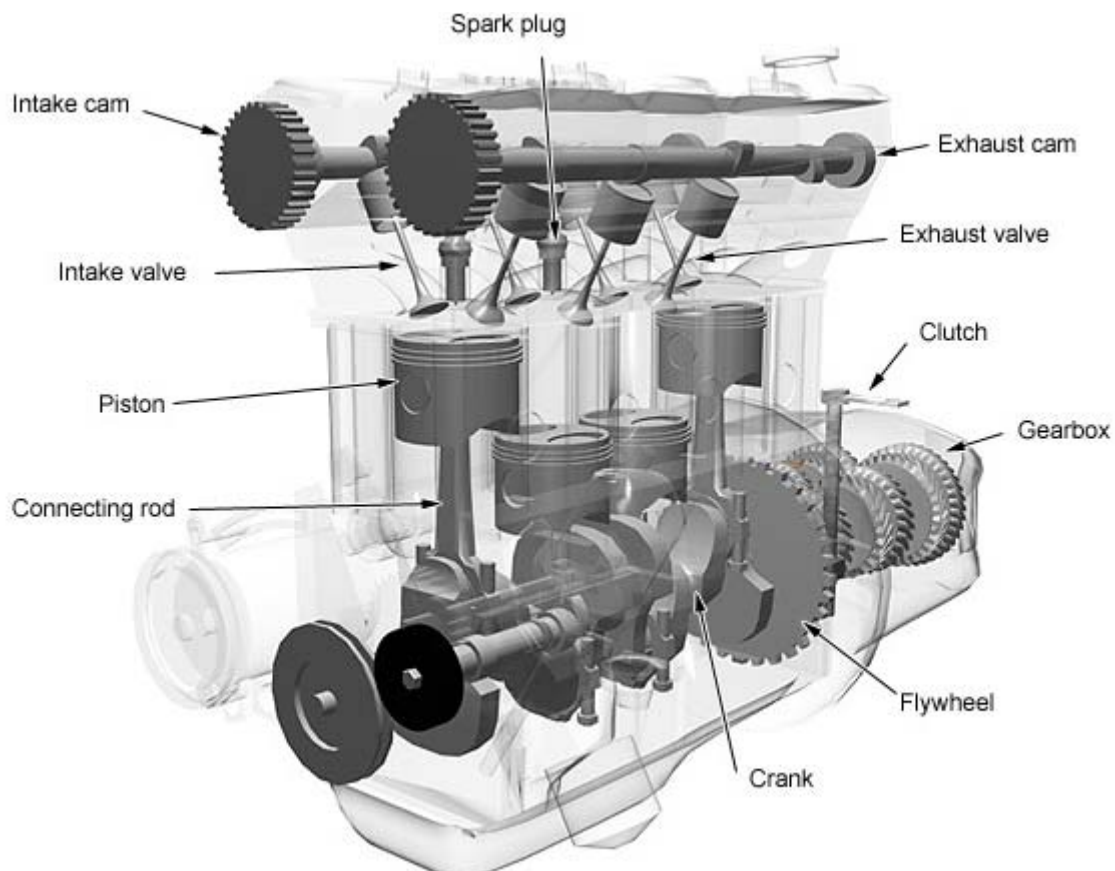
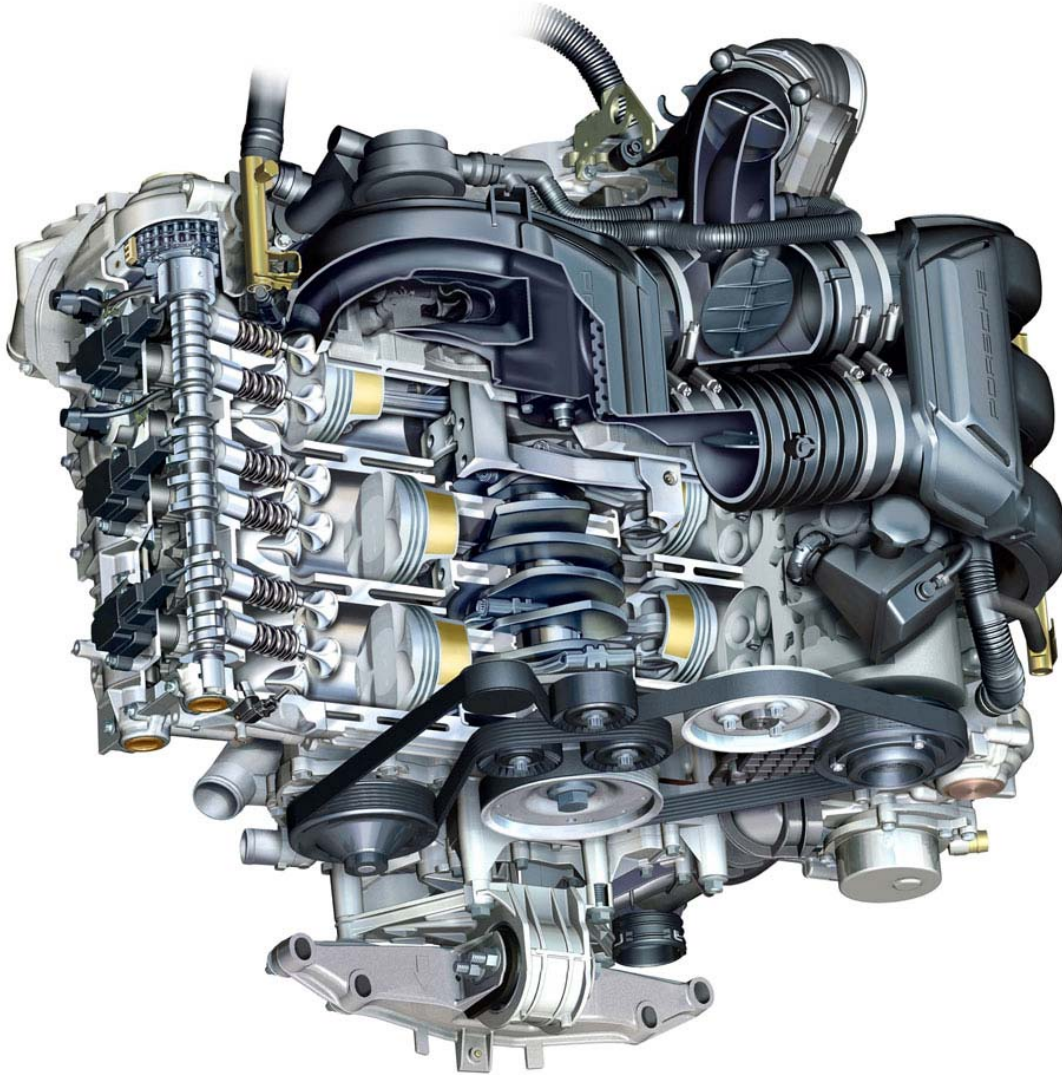


Figure 1: Four-cylinder in-line engine [CARBIBLES 2007]

*Boxer engine* (figure 2), also known as horizontally opposed engine or flat engine, is more compact than in-line engine, and has a lower center of gravity than any other common

configurations which gives a better stability and control to the vehicle. This type of engine, however, is wider than more traditional arrangement and is more expensive to build. The extra width may cause problems fitting the engine into the engine bay of a front engine car owing to the interference with the steering wheels. This type of engine is used by car manufacturers like Subaru or Porsche but also for motorbike by manufacturers like BMW.



**Figure 2: Six-cylinder boxer engine [PORSCHE 2007]**

### 3.1.2. Crankshaft

For *in-line engines*, we consider two arrangements of the crankshaft. The first one has its two crankpins, one for each connecting rod, on the same line grid, which means that the two pistons are moving in phase (reaching the top dead center (TDC) and bottom dead center (BDC) at the same time), so it is referred later as the *in-phase arrangement* (see figure 3). In the second configuration of the crankshaft, there is a phase shift of 180 degrees between the two crankpins; this phase shift leads to an out-of-phase movement of the piston (one piston

reaches the TDC when the second reaches the BDC), so it is referred later as the *out-of-phase arrangement* (see figure 4).

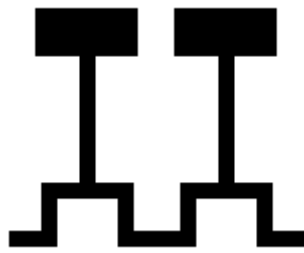


Figure 3: In-phase configuration (in-line engine)

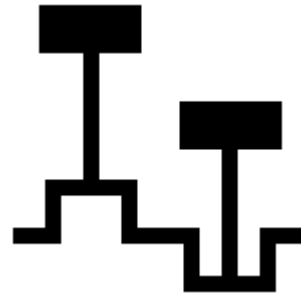


Figure 4: Out-of-phase configuration (in-line engine)

#### 3.1.2.1. Remark 1

We consider for *boxer engines*, the same arrangements of the crankshaft, but it is important to notice that in this case, the *in-phase arrangement* (two pistons moving in phase) corresponds to the crankshaft having a phase shift between its two crankpins (figure 5) and the *out-of-phase arrangement* corresponds to the crankshaft with the crankpins on the same line grid (figure 6). The names **in-phase and out-of-phase relate to the relative position of the pistons** and not to the relative position of the crankpins.

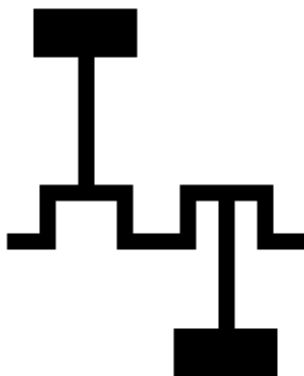


Figure 6: Out-of-phase configuration (boxer engine)

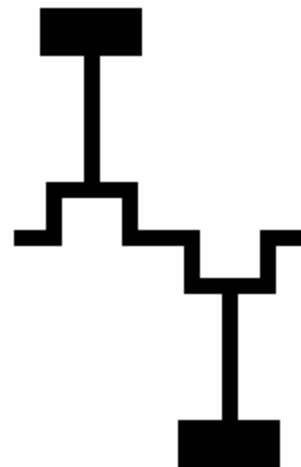


Figure 5: In-phase configuration (boxer engine)

#### 3.1.2.2. Remark 2

We only consider here crankshafts having two crankpins. Nevertheless, it is possible to use a single long crankpin instead of two crankpins on the same line grid (figure 7) for the in-phase in-line engine or for the out-of-phase boxer engine. At this point of the modeling, we choose not to focus on single crankpin crankshaft because it does not match with the modeling of the counterweights. We prefer to have the counterweight in front of the corresponding piston in order to minimize free moments due to the offset between the forces generated by the piston and the forces generated by the counterweight. This can be achieved practically by dividing

the mass of the counterweight between the two corresponding crank arms (figure 8), which is impossible for two connecting rods having only one crankpin.

Since the cylinders of the boxer engine are not on the same side of the crankshaft, the distance between the bore centers is not restrained by the cylinders size. So this distance could be reduced. In the case of the out-of-phase boxer engine, we could go further and put the two cylinders on the same axis and use one connecting rod with a big end in shape of fork and one normal connecting rod (figure 9). We will come back later to these solutions if they show some potential interest for our engines.

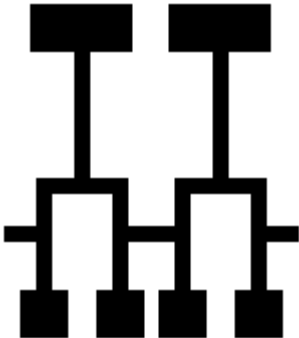


Figure 8: Position of the counterweights for a crankshaft with two crankpins

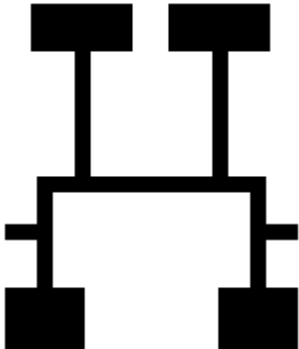


Figure 7: Position of the counterweights for a crankshaft with only one crankpin

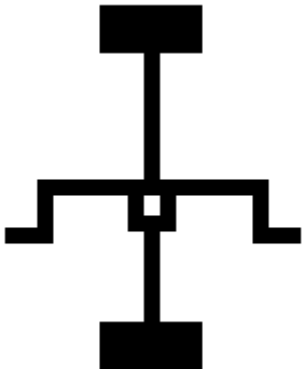


Figure 9: Fork connecting rod for out-of-phase boxer engine

### 3.1.3. Strokes

For the four configurations described previously (two engines and two crankshafts), we use, in this study, two different sets of data provided by Breuer Technical Development (see table 1 and figure 10). One corresponds to a stroke of 86,4mm that we call *shorter stroke engine* (if we compare the stroke to the cylinder bore 79,5mm, it is still a long stroke engine) while the other one with a stroke of 95,5mm is called *longer stroke engine*.

	Shorter stroke	Longer stroke
Cylinder bore $b$ (mm)	79,5	79,5
Distance between piston centers $a$ (mm)	88	88
Stroke $2r$ (mm)	86,4	95,5
Crank arm length $r$ (mm)	43,2	47,75
Connecting rod $l$ (mm)	136	144
Stroke to connecting rod ratio $\lambda=r/l$	0,3176	0,3316
Rotation speed (rpm)	4000	4000
Piston (pin included) weight (kg)	0,7172	0,7754
Connecting rod weight (kg)	0,7131	0,6287
Unbalance mass of one half crank (kg*m)	0,02054	0,02001

Table 1: Reference data of the shorter and longer stroke engines

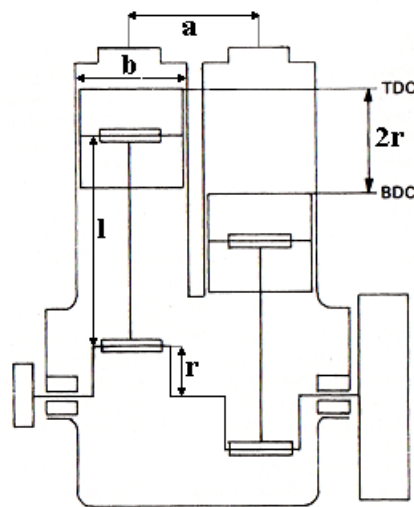


Figure 10: Geometry and data of the engines

### 3.1.4. Balance shafts

We also consider the possibility to use one or several balance shafts to counteract some of the residual forces. These shafts are designed to balance forces of one defined order. For the first order forces, the balance shafts should rotate at the same speed that the crankshaft whereas they should revolve at twice the crankshaft speed to counteract second order forces etc. The precise speed and phase shift of the balance shafts are obtained by connecting these shafts to the timing chain or belt with sprocket wheels or pulleys of appropriate diameters (i.e. half size of the crankshaft sprocket wheel to have the double speed).

The balance shafts are realized with an unbalance mass so when they revolve, they produce a rotating force. To balance the reciprocating force of the piston, the rotating force of the balance shaft can be transformed into an oscillating force by using two counterrotative balance shafts (see figure 11) . The component in the direction perpendicular to the cylinder bank (Y-direction) of the force generated by one balance shaft is compensated by the force generated by the second balance shaft. The two balance shafts have to be placed symmetrically on each side of the cylinder bank in order to produce no free moments.

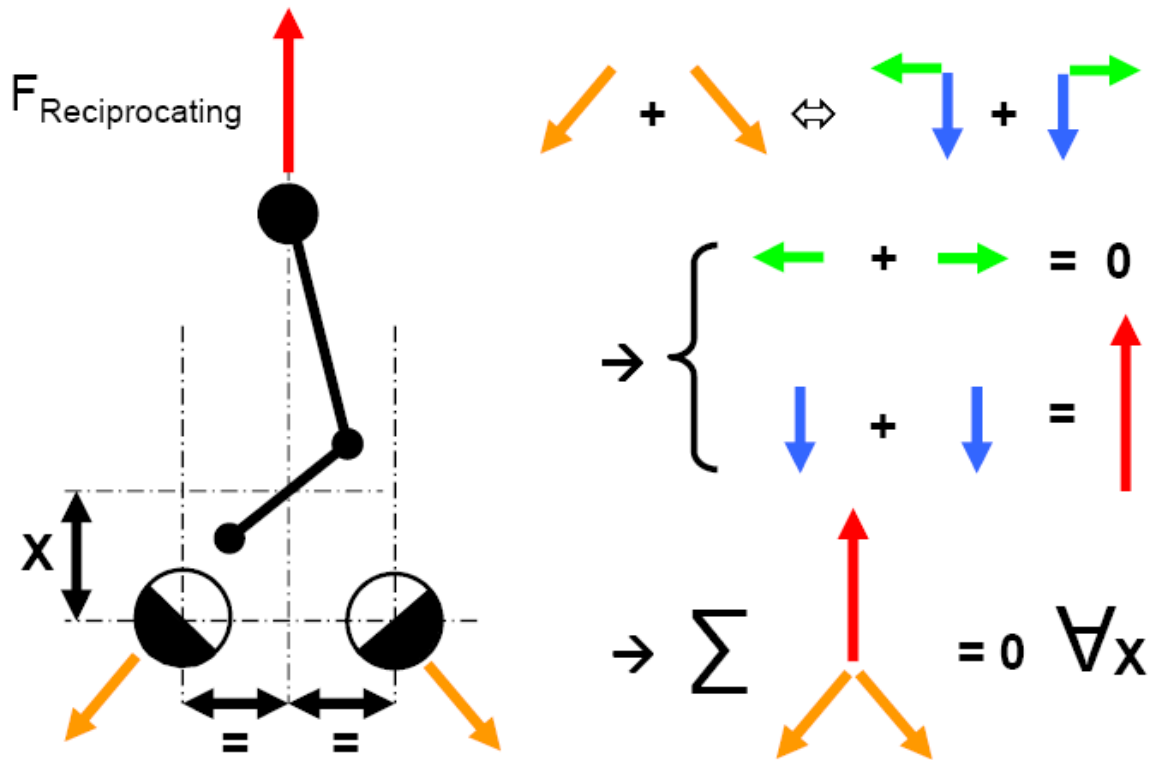


Figure 11: Two balance shafts balancing piston force (one order)

If we use balance shafts to counteract first order forces or moments, it is possible to use only one balance shaft. Because one of the two balances shaft rotates in the same direction that the crankshaft, so its unbalance mass can be added to the crank one. Thus, we keep only the modified crankshaft and the counterrotative balance shaft, the problem with that method is that the forces generated in the direction of the piston motion (X-direction) by both shafts and the piston are not aligned, neither the Y-forces so they produce rolling moments.

In the same manner, to counteract second order forces, we can use only one balance shaft. But, as the rotation speed of the balance shaft and the crankshaft are different, the second order Y-forces generated by the balance shaft can not be compensated by the unbalance mass of the crank. So we can decrease second order X-forces at the price of an increase in perpendicular forces and rolling moments.

## 3.2. Modeling

### 3.2.1. Coordinate system

In this study, the most convenient coordinate systems are right-handed Cartesian coordinate systems. We choose to use the direction of the cylinder as X-axis and the direction of the crankshaft as Z-axis, the direction of the Y-axis is deduced from the two other axes using the right hand rule (figures 12 & 13).



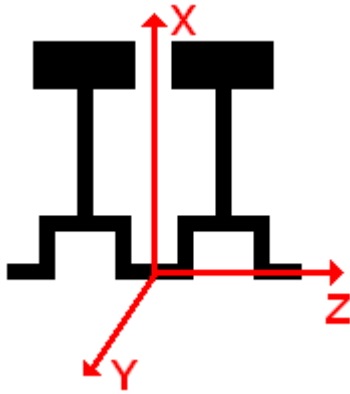


Figure 13: Coordinate system for the in-line engine

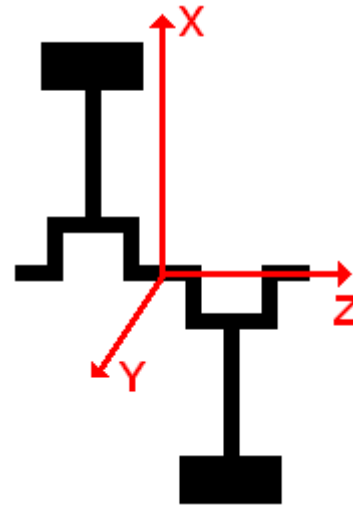


Figure 12: Coordinate system for the boxer engine

### 3.2.2. Assumptions

In this preliminary study, we make a few assumptions that are commonly accepted for the calculation of inertia forces and moments in engine.

We consider the engine as a rigid body mechanism. We do not take into account the flexibility of the different parts of the engine. The engine is seen as the sum of uncoupled cylinder sub-systems i.e. the forces generated by each piston and each crankshaft counterweight are calculated separately. Then, all single forces are summed to give the total forces and moments that are produced by the engine.

We separate the parts that experience a reciprocating movement (piston, gudgeon pin) and the ones that undergo a rotating movement (crankshaft, counterweight). The case of the connecting rod is more difficult because it has both an oscillating and rotating movements, so we make the assumption that one third of the connecting rod mass (small end) is a reciprocating mass and two third (big end) is a rotating mass [BOSCH 2000, pp. 397].

We suppose that all the forces in the Z-direction (direction of the crankshaft) are equal to zero.

We neglect the forces of the pistons against the cylinder wall or sleeve (piston slap).

We suppose also that the forces generated by the rotating mass related to one cylinder and the forces generated by the reciprocating mass of the same cylinder are included in the same Z-plane.

The oscillating inertia forces could be calculated using some relationships between the angle of the crank  $\theta$ , the pivoting angle of the connecting rod and the stroke to connecting rod ratio  $\lambda$  ( $= r/l$ ). All these relationships can be represented in the form of a Fourier series. In this series, we neglect the higher order terms and some coefficients if it leads to an error smaller than 0,1%.

### 3.2.3. Equations

#### 3.2.3.1. For one cylinder

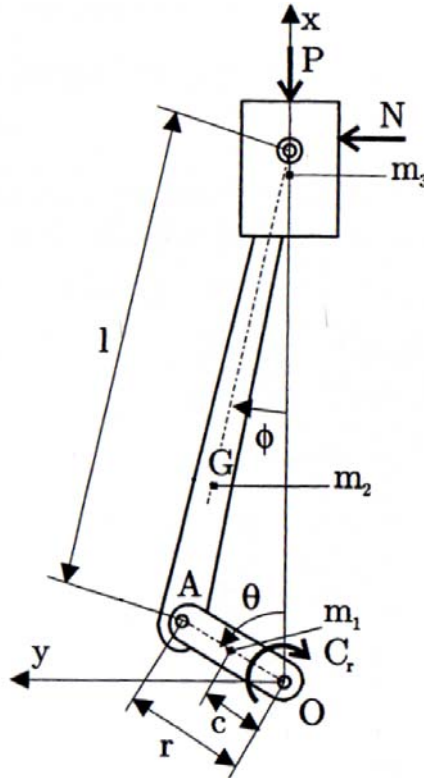
We start with writing the equations of the piston motion ( $s$ ), obtained by projection on the vertical (equation (1)) and horizontal (equation (2)) axes of the figure 14 [GOLINVAL 2001]. By deleting the angle  $\phi$  from the relations (1) and (2), the equation (3) that links the piston motion to the crankshaft angle is obtained. This relation can be linearized (equation (4)).

$$s = r \cdot \cos \theta + l \cdot \cos \phi \quad (1)$$

$$0 = r \cdot \sin \theta - l \cdot \sin \phi \quad (2)$$

$$s = r \cdot \left( \cos \theta + \frac{1}{\lambda} \cdot \sqrt{1 - \lambda^2 \cdot \sin^2 \theta} \right) \quad (3)$$

$$s = r \cdot \left( A_0 + \cos \theta + \frac{1}{4} \cdot A_2 \cdot \cos 2\theta + \frac{1}{16} \cdot A_4 \cdot \cos 4\theta + \dots \right) \quad (4)$$



**Figure 14: Piston motion, oscillating and rotating masses [GOLINVAL 2001]**

$$A_0 = \frac{1}{\lambda} - \frac{1}{4} \lambda - \frac{3}{64} \lambda^3 - \frac{5}{256} \lambda^5 + \dots \quad (5)$$

$$A_2 = \lambda + \frac{1}{4} \cdot \lambda^3 + \frac{15}{128} \cdot \lambda^5 + \dots \quad (6)$$

$$A_4 = -\frac{1}{4} \cdot \lambda^3 - \frac{3}{16} \cdot \lambda^5 + \dots \quad (7)$$

$$A_6 = \frac{9}{128} \lambda^5 + \dots \quad (8)$$

Next, we calculate the inertia forces for one cylinder [MAASS 1981, pp. 115]. The oscillating mass is the mass of the piston and the connecting rod (see figure 14) while the rotating mass is the mass of the connecting rod and the crankshaft.

$$F_y = r \cdot \omega^2 \cdot m_r \cdot \sin \theta \quad (9)$$

$$F_x = r \cdot \omega^2 \cdot [m_r \cdot \cos \theta + m_o \cdot (\cos \theta + A_2 \cdot \cos 2\theta + A_4 \cdot \cos 4\theta + A_6 \cdot \cos 6\theta + \dots)] \quad (10)$$

$$F_{res} = \sqrt{F_x^2 + F_y^2} \quad (11)$$

$$m_r = \text{rotating mass} = m_1 + 2/3 m_2 \quad (12)$$

$$m_o = \text{oscillating mass} = m_3 + 1/3 m_2 \quad (13)$$

Having the equations of the inertia forces for one cylinder and taking care of the configuration, we can write the equations for a second cylinder in a similar way.

### 3.2.3.2. In-line engine, in-phase arrangement

As one can see in figure 3, the two pistons in in-line, in-phase configuration have the same orientation and work in phase. So the forces generated by the second cylinder can be calculated with the same equations than the ones used for the first cylinder. Since the parts are identical for the two cylinders, the forces generated for the complete engine are exactly the double of the forces generated by one cylinder.

### 3.2.3.3. In-line engine, out-of-phase arrangement

As we can see in figure 4, the second piston has a phase shift of 180° with the first one. So for the second cylinder, we replace ( $\theta$ ) by ( $\theta+180$ ).

According to:

- $\cos (\theta+180) = -\cos (\theta)$
- $\sin (\theta+180) = -\sin (\theta)$
- $\cos (2*(\theta+180)) = \cos (2* \theta)$
- $\cos (4*(\theta+180)) = \cos (4* \theta)$
- $\cos (6*(\theta+180)) = \cos (6* \theta)$

We can conclude that the first order forces for the second cylinder are the opposite of the first order forces for the first cylinder. But, the forces of higher orders are equal for both cylinders. So when the effects of the two cylinders are taken into account, the total first order forces are zero but there are resulting first order moments due to the offset between the two cylinders.

The higher orders forces generated for the complete engine are exactly the double of the higher orders forces generated by one cylinder.

#### 3.2.3.4. Boxer engine, out-of-phase arrangement

In the boxer engine, the second cylinder is opposed to the first one, so the forces generated by both cylinder are also opposed, thus we have to change the sign of the forces from the second cylinder. As seen in figure 6, the pistons are moving out of phase, so one needs also to replace  $(\theta)$  by  $(\theta+180)$  for the second cylinder. Finally, this configuration is the opposite of the in-line engine out-of-phase arrangement i.e. the first order forces are doubled while the resulting higher orders forces are canceled, which also introduces free moments of higher order ( $>1$ ).

#### 3.2.3.5. Boxer engine, in-phase arrangement

In this case, the movement of the two pistons is permanently opposed (figure 5). So the forces of the second cylinder are exactly the opposite of the forces of the first cylinder. Thus, the resulting inertia forces of the engine are null for all orders; but the opposed forces create moments (first and higher orders) in the engine.

A summary of the different forces and moments acting on the engine is presented in table 2.

	First order forces	High order forces ( $>1$ )	First order moments	High order moments ( $>1$ )
In-line, in-phase	Yes	Yes	No	No
In-line, out-of-phase	No	Yes	Yes	No
Boxer, in-phase	No	No	Yes	Yes
Boxer, out-of-phase	Yes	No	No	Yes

**Table 2: Forces and moments in the different configurations of twin-cylinder engine**

#### 3.2.3.6. Balance shafts

The force generated by a balance shaft can be expressed in the two main directions (X and Y) under the form:

$$F_x = r_{bs} \cdot m_{bs} \cdot \omega^2 \cdot \cos \theta \quad (14)$$

$$F_y = r_{bs} \cdot m_{bs} \cdot \omega^2 \cdot \sin \theta \quad (15)$$

$$r_{bs} \cdot m_{bs} = \text{unbalance mass of the balance shaft}$$

#### 3.2.3.7. Calculations of the moments

Depending on the configuration of the engine, it can exist free moments due to a difference between the forces generated by the cylinders or by the balance shafts. These moments are calculated with respect to the *middle of the crankshaft*. We can separate the resulting moment in three moments, one around each main direction:

- $M_x$  is the yawing moment (see figure 15)
- $M_y$  is the pitching moment
- $M_z$  is the rolling moment
- $M_{res}$  is the resulting moment

$$M_x = F_{y1} \cdot \frac{a}{2} - F_{y2} \cdot \frac{a}{2} - Z_3 \cdot F_{y3} - Z_4 \cdot F_{y4} \quad (16)$$

$$M_y = -F_{x1} \cdot \frac{a}{2} + F_{x2} \cdot \frac{a}{2} + Z_3 \cdot F_{x3} + Z_4 \cdot F_{x4} \quad (17)$$

$$M_z = -Y_3 \cdot F_{x3} - Y_4 \cdot F_{x4} + X_3 \cdot F_{y3} + X_4 \cdot F_{y4} \quad (18)$$

$$M_{res} = \sqrt{M_x^2 + M_y^2 + M_z^2} \quad (19)$$

- Indices 1 and 2 relate to the two cylinders
- Indices 3 and 4 relate to the two balance shafts
- $X_i$ ,  $Y_i$  and  $Z_i$  are the coordinates of the balance shafts
- $a$  is the distance between the bore center

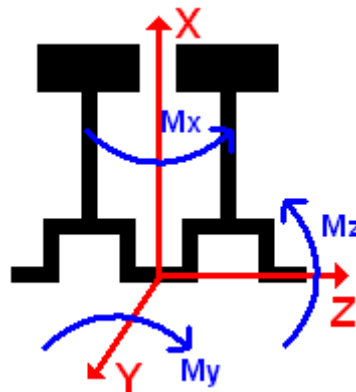


Figure 15: Definition of the three moments

### 3.2.3.8. Forces due to the gas pressure

To calculate the force generated by the gas pressure on the piston, we multiply the relative pressure ( $p$ ) by the area of the piston (equation (20)).

$$F_{x,gp} = p \cdot \pi \cdot \left(\frac{b}{2}\right)^2 \quad (20)$$

To calculate the torque of the engine, the gas force is added to the inertia force which gives the total force in the cylinder (equation (21)). This force is then multiplied by the effective lever arm (since the crankshaft rotates, the length of the lever arm varies between zero and the length of the crank arm ( $r$ )). That gives the instantaneous torque ( $T_i$ ) generated by one cylinder (equation (22)). The sum of the torque generated by each cylinder is averaged over 720 degrees to have the brake torque ( $T$ ) of the engine.

$$F_{x,gp} + F_{x,inertia} = F_{x,total} \quad (21)$$

$$T_i = F_{x,total} * r * \sin \theta \quad (22)$$

The gases obtained by the fuel combustion create a pressure acting on the cylinder sleeve, on the piston and on the cylinder head (see figure 17). This pressure is modeled by four forces in the two dimensions drawing of the figure 16. It appears clearly that the horizontal forces ( $H_l$  and  $H_r$ ) are equivalent and opposed (in a real view, since the cylinder is round, there is an endless number of forces in the horizontal plane nevertheless the resulting force is still null). So the resultant forces on the cylinder sleeve are null and there are no lateral forces due to the gas pressure.

The force acting on the piston is the one that produces the useful torque. The force is transmitted from the piston to the crankshaft through the connecting rod and from the crankshaft to the engine block ( $V_p/2$ ) through the bearings. The gas pressure creates exactly the same force on the cylinder head but in the other direction ( $V_c = -V_p$ ). This force is transmitted from the cylinder head to the engine block ( $v_c/2$ ) by the cylinder head bolts. And thus there are no resulting forces because the two forces counteract each other ( $V_c/2 = -V_p/2$ ).

The forces due to the gas pressure are inner forces; they are only responsible for the torque and for tensile stresses in the engine block [VANOVERSCHELDE 2008]. **They do not need to be balanced.**



Figure 17: Gas pressure inside one cylinder

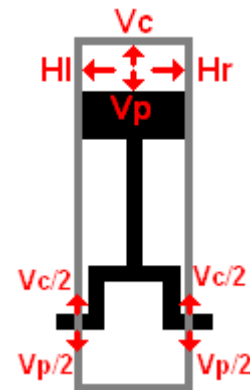


Figure 16: Forces resulting from the gas pressure

## 4. Evaluation and balance of inertia forces

In this section, we first discuss shortly about the equations of the forces in the engine and the approximations that can be made. After that, we simulate two single-cylinder engines (shorter and longer stroke engines) and different arrangements of two-cylinder engine. Then, we give the results of the calculation of forces and moments for the different configurations of engine described previously (the complete set of curves for all longer stroke twin-cylinder configurations are given in the appendix A). The calculation of forces and moments is carried out for an engine rotation speed of **4000 rpm** because it is its maximum rotation speed and it gives the maximum inertia forces. For each engine configuration, we are first interested in the resulting forces and moments for the basic crankshaft (well balanced, no rotating forces generated). Then we study the effect of the unbalance mass of the crankshaft and search for an optimal value of this unbalance mass (minimization of the resulting forces or moments). After that, we compare different configurations of balance shafts and different combinations of crankshaft and balance shafts. We also investigate the effect of the gas pressure in the model.

### 4.1. Approximation of equations

The equation (10) used to determine the value of  $F_x$  is a Fourier series with some coefficients  $A_0, A_2, A_4, A_6 \dots$ . All of them do not have the same importance and some of them can be neglected. These coefficients are composed of different powers of the stroke to connecting rod ratio  $\lambda$ . The value of  $\lambda$  is 0,32 so it means that  $\lambda^5$  is 0,0033 which is one percent of  $\lambda$ . Therefore we guess that some terms with higher power of  $\lambda$  could be neglected. We determine in this section which terms in  $\lambda$  and which order of forces can be neglected. To this end, we compare, in table 3, the error on the maximum force and the mean value (averaged over one rotation of the crankshaft) of the relative error between the values of  $F_x$  with the equations limited to a given order (first, second or fourth) and the values of  $F_x$  with the equations limited to the sixth order (we assume that the equations limited to the sixth order are already sufficiently accurate) in the case of the shorter stroke single cylinder engine (described in point 4.2).

Approximation	$F_{x,max}$ (N)	Error on $F_{x,max}$ (%)	Mean error (%)
First order	7238,0	24,11 %	101,18 %
Second order	9597,9	0,64 %	1,80 %
Fourth order	9535,5	0,02 %	0,04 %
Sixth order	9537,1		

**Table 3: Maximum forces and related errors for different approximations of the equations**

We notice in table 3 that the error committed if we use only the first order of the equation is very important, 24% on the maximum value but also more than 100 % in the mean (the relative error can be huge when the force is close to zero). According to these results, we choose to work with the first, second and fourth orders terms and to neglect the sixth and higher orders terms because with this simplification, the committed error is less than 0,1% (Mean relative error between fourth and sixth order is 0,04 %, and error between sixth order and higher orders are even smaller).

By reviewing literature [BOSCH 2000], we note that some authors neglect the terms of the third and higher powers in  $\lambda$ . So the calculations are made with only the first order terms and the coefficients of the second order limited to  $\lambda$ . We compare the results obtained with this approximation ( $F_{x,max} = 9537,1$  N) with the results of the complete sixth order equation ( $F_{x,max} = 9537,1$  N). The error on the maximum values of  $F_x$  is nearly null (less than 0,1%). This is due to the fact that the coefficients neglected at the second order ( $1/4*\lambda^3+15/128*\lambda^5$ ) and sixth order ( $9/128*\lambda^5$ ) are exactly the opposite of the coefficient of the fourth order ( $-1/4*\lambda^3-24/128*\lambda^5$ ). Then for  $\theta = 0+k*360^\circ$  (which is the position that give the maximum value of  $F_x$  in this configuration), the error is nearly zero but in the mean, the relative error is 3,8 %. Moreover, we make an error of three percents on the values of the second order forces. So if we choose to balance these forces by counterrotative balance shafts, this will result in an error on the values of the unbalance mass of the shafts. Therefore we decide to work with the first, second and fourth orders of the equations (limited to terms in  $\lambda$ ,  $\lambda^3$  and  $\lambda^5$ ).

## 4.2. Shorter stroke single-cylinder engine

### 4.2.1. Reference data (case 1)

We are interested first at the most basic engine, one cylinder, with no balance shaft and a well-balanced crankshaft. This means that the crankshaft and the related part of the connecting rod produce no forces. We focus mainly on the forces in the direction of the piston motion (figure 18).

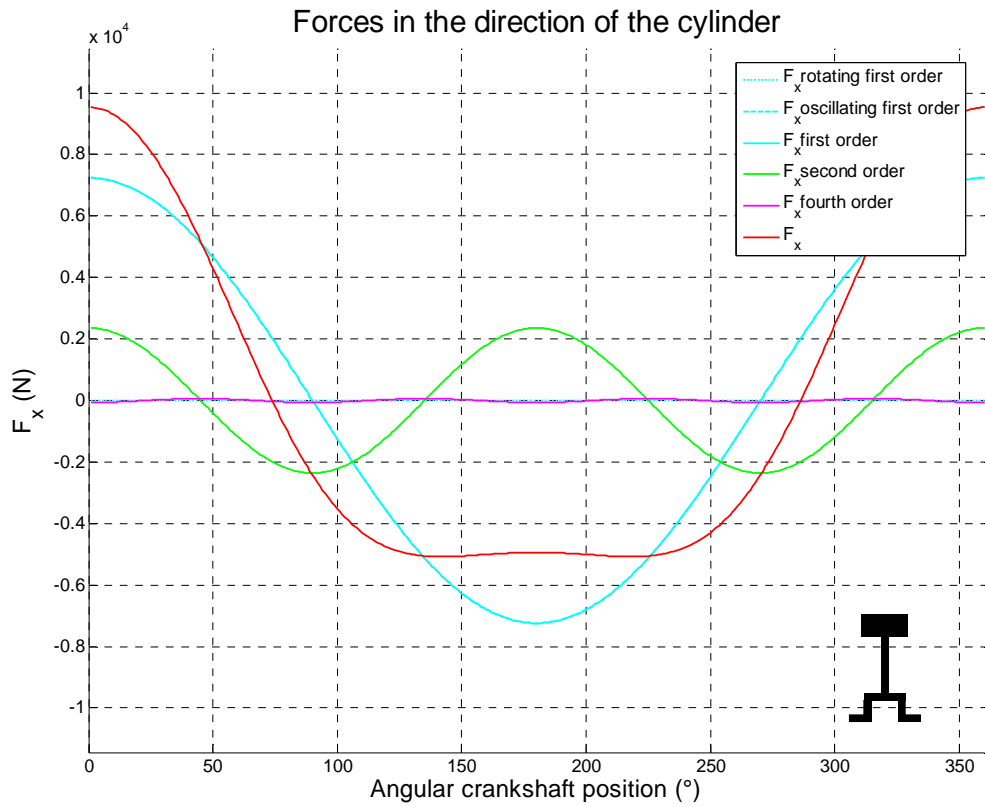
We can see that the forces due to the rotating parts are zero (dotted light blue line), the counterweights are designed to balance the crankshaft and the connecting rod. Then we note that the dominating force is the first order reciprocating force (dashed light blue line) because the movement of the piston is not balanced (maximum value is 7238,1 N). These two forces are first order and their sum is the total first order force in the X-direction (solid light blue line), since the rotating effect is zero, the total first order force is limited to the oscillating component.

Another force with a less important effect but not negligible (maximum value is 2360 N which is 33% of first order maximum value) is the second order force (green line); we can notice that the frequency of the second order effect is, obviously, the double of the first order force.

The force of the fourth order is also represented (magenta line) but it is close to zero (maximum is 31,3 N) and it could be neglected in first approximation.

The red line is the total force in the X-direction ( $F_x$ ) and it corresponds to the sum of all forces described previously. We can see that for  $\theta = 0^\circ$  (TDC), first order and second order forces have the same direction and their effects add to each other to reach the maximum value of  $F_x$  which is 9535,5 N. But for  $\theta = 180^\circ$  (BDC), first order forces are negative whereas the second order forces are positive so the second order forces reduce the peak value (the maximum negative force is 5077,5 N at  $\theta = 142^\circ$  &  $218^\circ$ ). So the total force in X-direction is smaller at the bottom dead center than at the top dead center.





**Figure 18:  $F_x$  for shorter stroke single-cylinder engine rotating at 4000 rpm**

In figure 19, we notice that the force in the Y-direction ( $F_y$ ) is, as expected, equal to zero.

Concerning the moments deriving from the forces, they are all null (figure 20). This is a consequence of the fact that the forces of the cylinder are applied at the center of the engine.

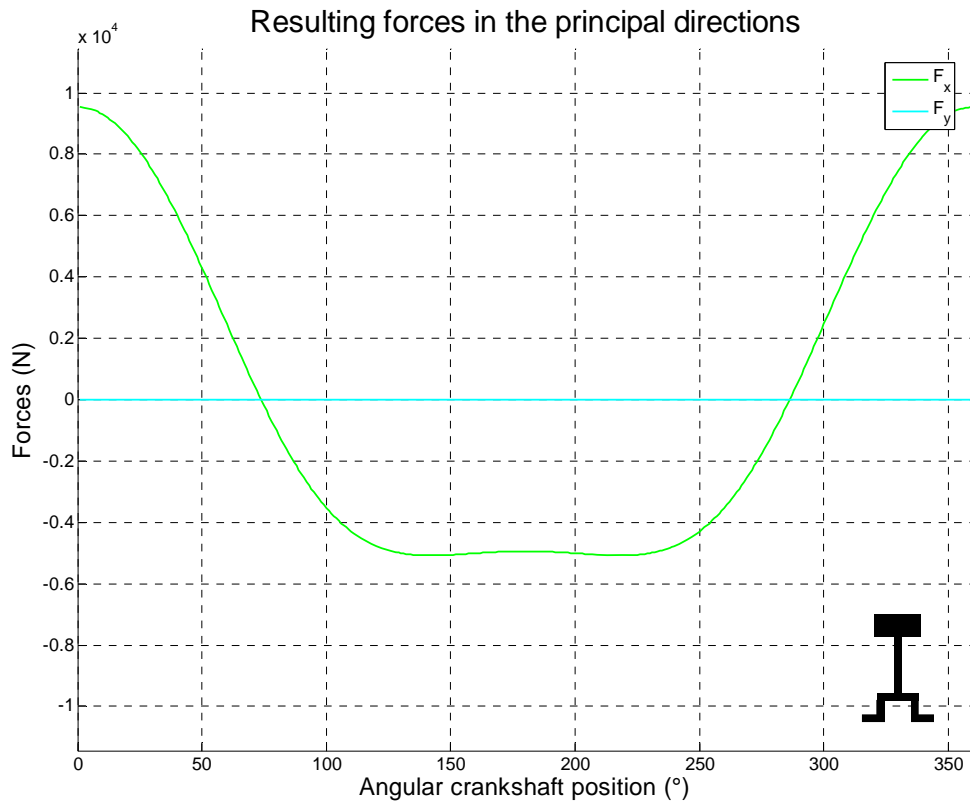


Figure 19:  $F_x$  and  $F_y$  for shorter stroke single-cylinder engine rotating at 4000 rpm

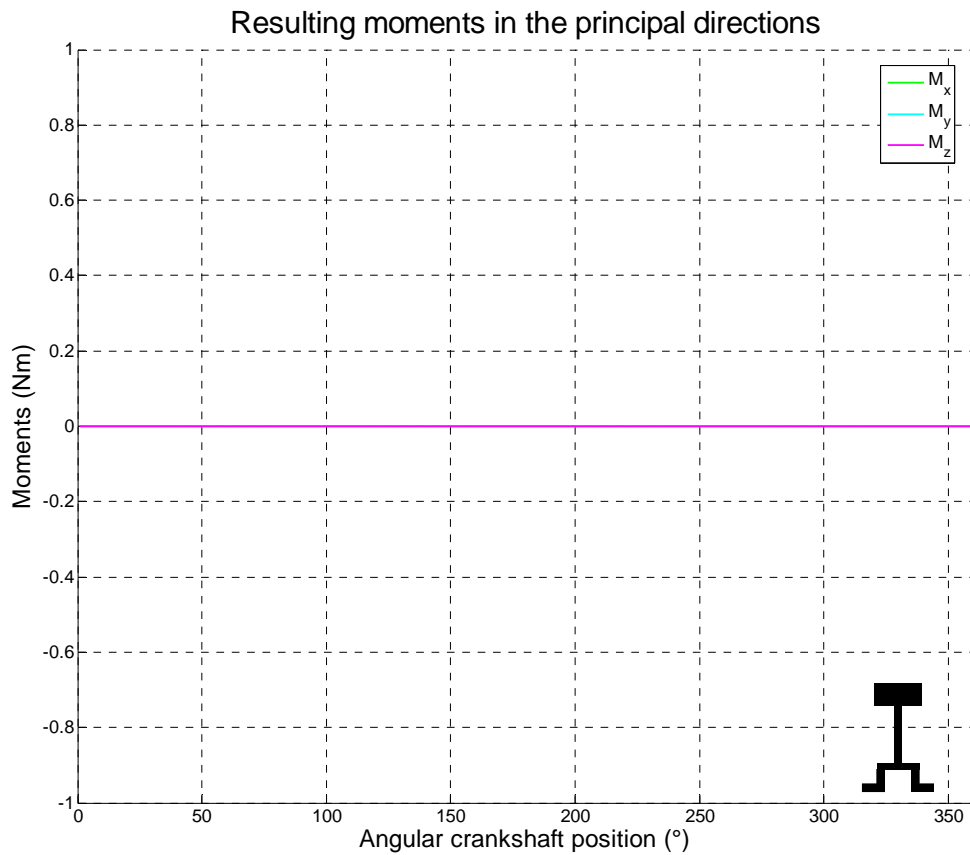
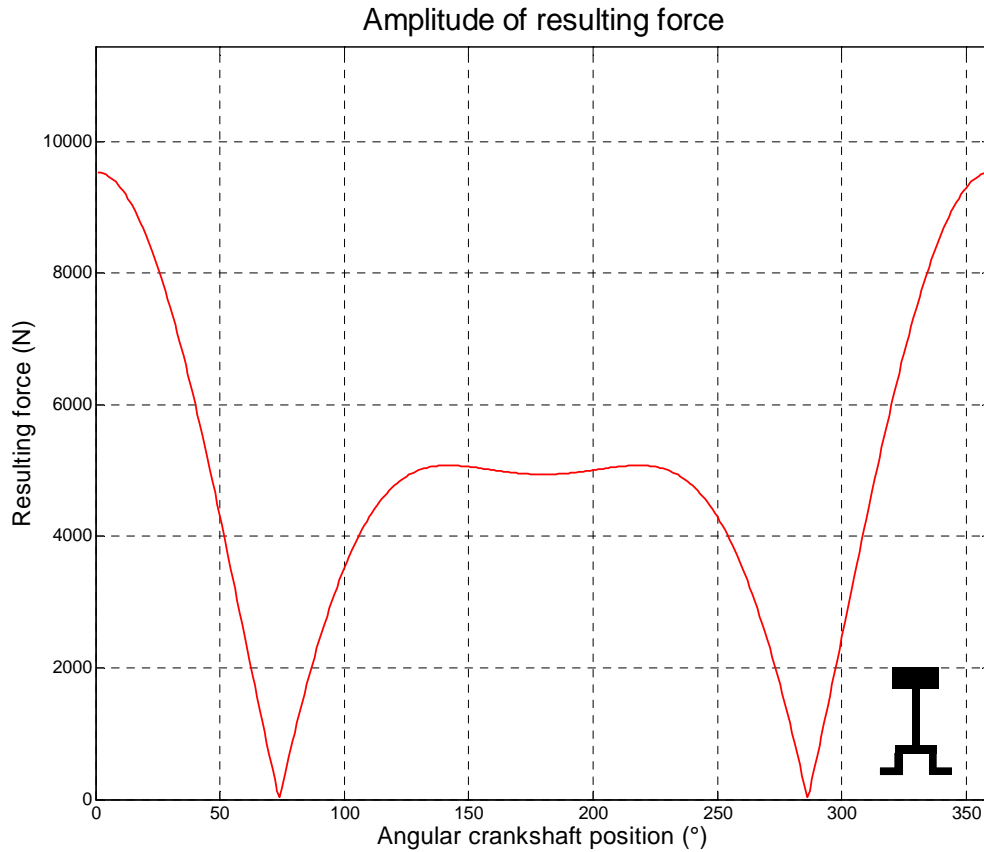


Figure 20:  $M_x$ ,  $M_y$  and  $M_z$  for shorter stroke single-cylinder engine rotating at 4000 rpm

Then, we calculate the resulting force ( $F_{res} = \sqrt{F_x^2 + F_y^2}$ , see figure 21). Since  $F_y$  is zero, the resulting force is equal to the absolute value of  $F_x$ .

The resulting moment is obviously equal to zero because all moments are zero.



**Figure 21: Amplitude of the resulting force for shorter stroke single-cylinder engine rotating at 4000 rpm**

$F_{x,max}$ (N)	9535,49
$F_{y,max}$ (N)	0,00
$F_{res,max}$ (N)	9535,49
$\Delta F_{res}$ (N)	4719,74
$M_{x,max}$ (Nm)	0,00
$M_{y,max}$ (Nm)	0,00
$M_{z,max}$ (Nm)	0,00
$M_{res,max}$ (Nm)	0,00
$\Delta M_{res}$ (Nm)	0,00

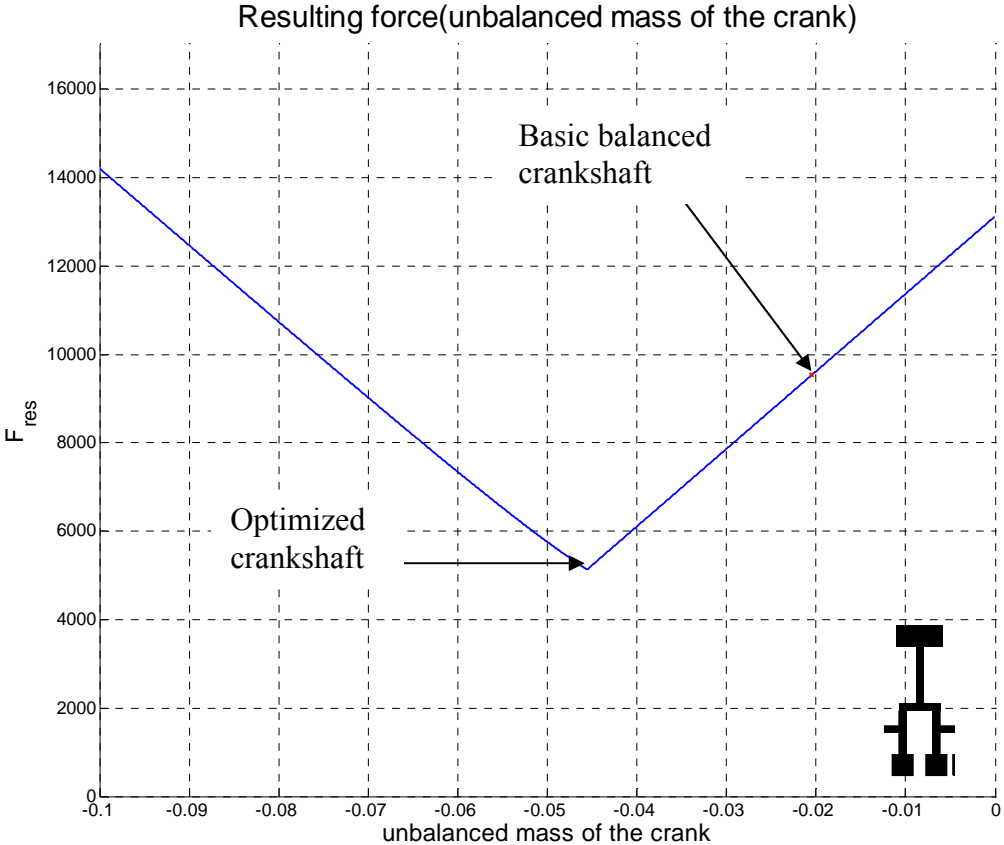
**Table 4: Maximum values of forces and moments for single-cylinder engine at 4000 rpm**

Table 4 presents a summary of the maximum values obtained for the principal forces and moments.  $\Delta F_{res}$  and  $\Delta M_{res}$  are the variations between the maximum and minimum value of  $F_{res}$  or  $M_{res}$ .

The single-cylinder engine is characterized by important forces (9535 N) of first, second and higher orders. In this case, the force is in pure X-direction; there is no effect in Y-direction due to the balancing of the crankshaft. One major advantage of this engine is that there is no resulting moments in any direction.

### 4.2.2. Optimization of the crankshaft (case 2)

The previous section shows that one disadvantage of the single-cylinder engine is the important forces (exclusively in X-direction) that are not balanced. We try here to reduce these forces by a proper choice of the crankshaft counterweights. We are aware that modifying the unbalance mass of the crank will increase the forces in the Y-direction; so to avoid increasing the total forces, we search the value of the unbalance mass of the crankshaft that minimizes the maximum resulting force ( $F_{res}$ ). This is carried out by making a parametric study of the unbalance mass with respect to the resulting force (figure 22). The red point indicates the reference value of the crankshaft. This means that an optimal choice of counterweight can nearly divides by two the maximum resulting force.

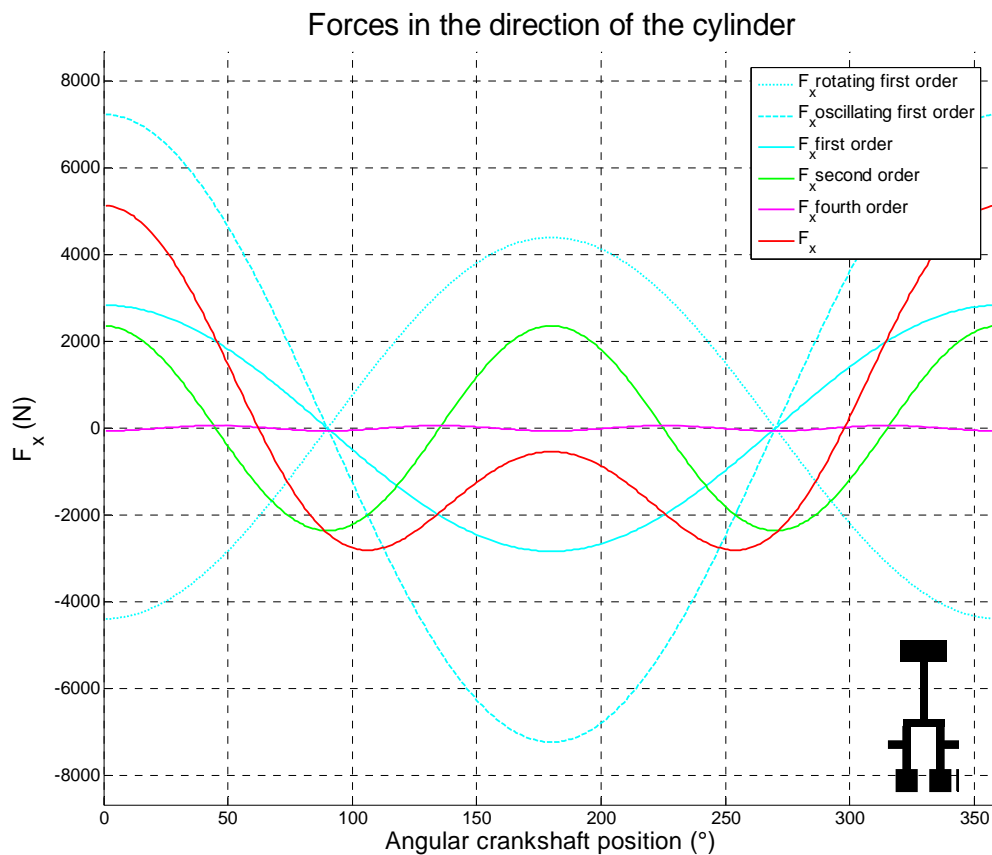


**Figure 22: Minimization of  $F_{res}$  in the shorter stroke single-cylinder engine by variation of the unbalance mass of the crank**

Now, we calculate the forces in the two main directions and the resulting force for the engine with the optimized crankshaft (unbalance mass of one crankshaft equal to 0,04561 kg\*m

instead of 0,02054 kg\*m). There is no need to calculate the moments because they are still equal to zero. The rotating force of the crankshaft has no influence on them.

Figure 23 shows that, compared to figure 18, the oscillating first order, the second order and fourth order forces are not modified. Only the rotating first order forces (dotted light blue line) have been modified and therefore the total first order force and total force in the X-direction. We notice that the maximum value of the oscillating force is a little higher than the maximum value of the rotating force but with a phase shift of  $180^\circ$  (principle of the counterweight). So the first order forces are reduce from 7238,1 N to 2838,9 N which is a decrease of 61%. When considering also the high order forces, one notices that the maximum value of the total force decreases from 9535,5 N to 5136,2 N, which is a decrease of 46% and the maximum negative value also decrease in the same proportion.

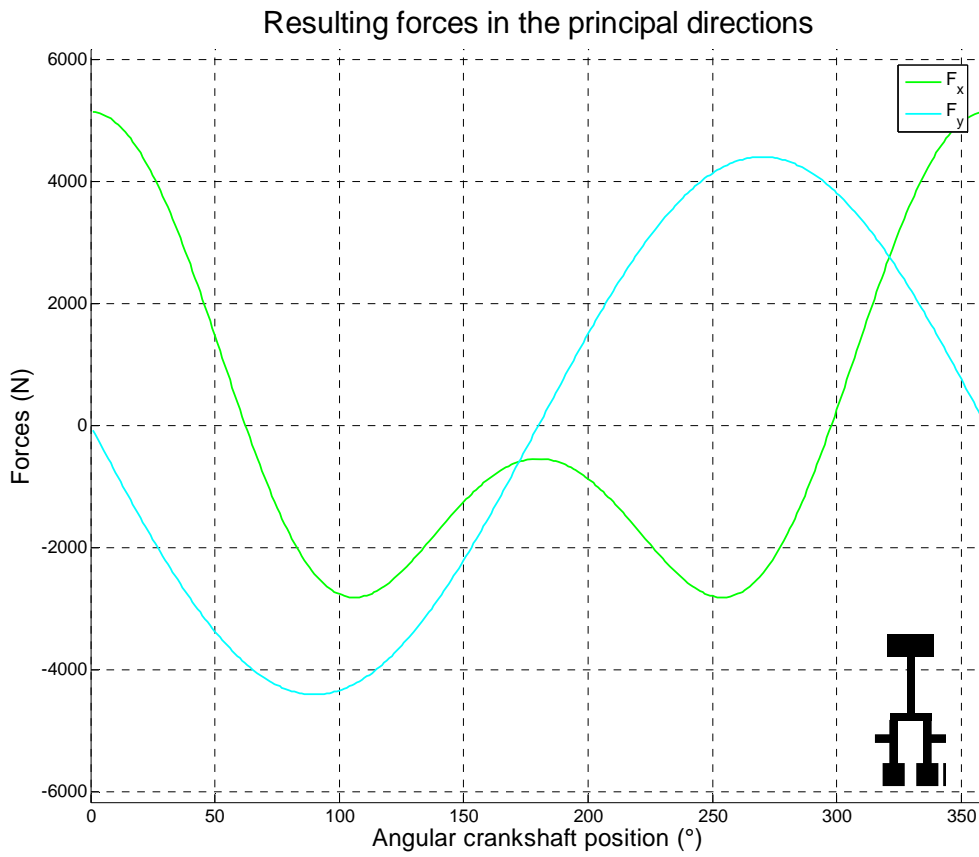


**Figure 23:  $F_x$  for optimized shorter stroke single-cylinder engine**

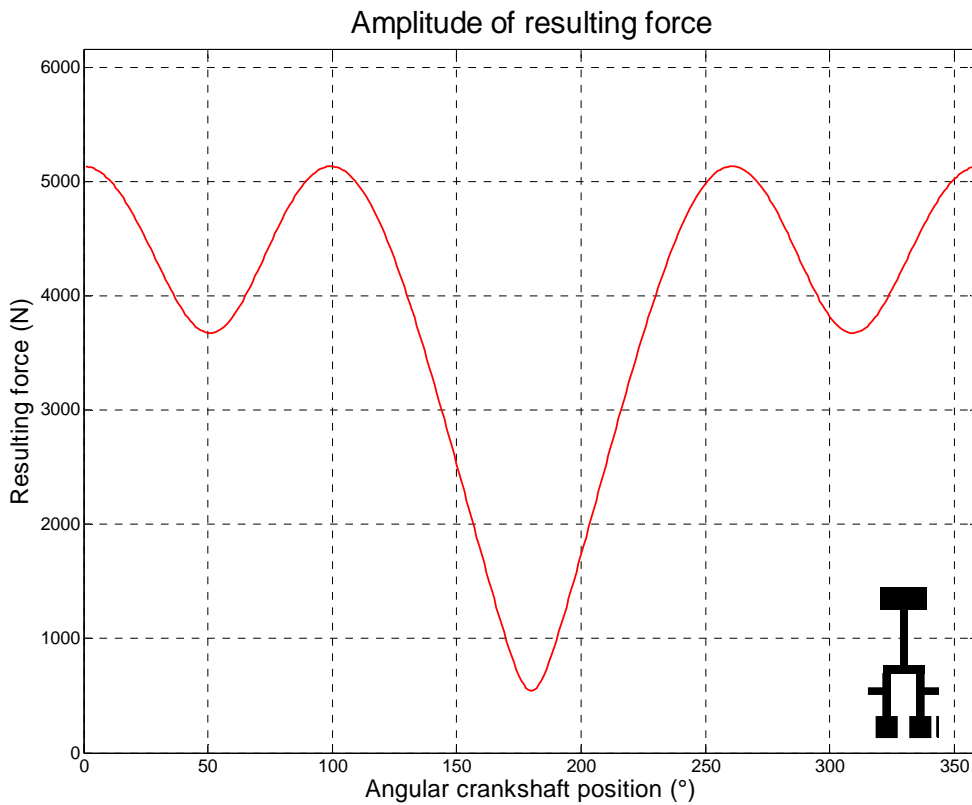
Figure 24 shows the total force in the X-direction, as in figure 19, but this time there is also a force in the Y-direction which is the opposite of a sinusoid. The maximum value of the Y-force is a little smaller than the X-force.

One notices, in figure 25, that the maximum value of the resulting force is not reached for only one position of the crankshaft as before but now in three positions. The first maximum is at the TDC as before and the force is in the X-direction. But there are two others maxima at  $90^\circ$  and  $270^\circ$ , these maxima are produced by the Y-forces and the second order X-forces.

Table 5 presents a summary of the key results.



**Figure 24:  $F_x$  and  $F_y$  for optimized shorter stroke single-cylinder engine**



**Figure 25:  $F_{res}$  for optimized shorter stroke single-cylinder engine**

$F_{x,max}$ (N)	5136,24
$F_{y,max}$ (N)	4399,25
$F_{res,max}$ (N)	5136,29
$\Delta F_{res}$ (N)	4595,02
$M_{x,max}$ (Nm)	0,00
$M_{y,max}$ (Nm)	0,00
$M_{z,max}$ (Nm)	0,00
$M_{res,max}$ (Nm)	0,00
$\Delta M_{res}$ (Nm)	0,00

**Table 5: Maximum values of forces and moments for optimized shorter stroke single-cylinder engine**

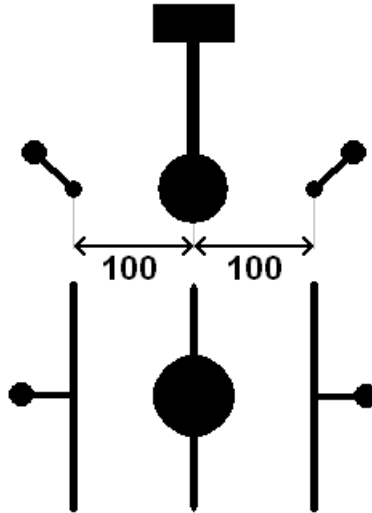
If we compare the results of table 4 and 5, we can conclude that we have achieved rather high reduction by simply modifying the counterweight of the crankshaft. Indeed, we have decreased the X-force at the price of an increasing of the Y-force. Nevertheless, the maximum of  $F_x$  and  $F_y$  are out of phase, thus the maximum of the resulting force is reduced by 46% and the variations of resulting force are also smaller.

Optimizing the counterweight of the crankshaft is a non-expensive solution to reduce vibrations and loads on engine supports.

### 4.2.3. Balance shafts

In this section, we compare different associations of balance shafts and crankshaft for the single-cylinder engine. We begin by adding one or two balance shafts to the engine to counteract first order forces, and then we do the same to counteract second order forces. In the case where we use only one first order balance shaft, the counterweights of the balance shaft are modified to play the role of a second balance shaft.

The position of the balance shafts is really important, especially if we use only one balance shaft. If the balance shafts are not well placed, they will produce forces that are not aligned with the piston and crankshaft forces and it will generate free moments. We choose to place the balance shafts in the same horizontal plane than the crankshaft at 100 mm (arbitrary choice) on each side of the cylinder plane (see figure 26). The balance shafts have to be placed symmetrically with respect to the cylinder row in order to produce no rolling moment. Lengthways, they are positioned at the middle of the engine to avoid free pitching or yawing moments.



**Figure 26: Position of the balance shafts in the shorter stroke single-cylinder engine**

#### 4.2.3.1. Basic crankshaft + two first order balance shafts (case 3)

We use in this configuration two balance shafts revolving at 4000 rpm to balance first order X-forces. The maximum X-force generated by the two balance shafts has to compensate the maximum first order X-force generated by the oscillating parts of the cylinder (the rotating parts are already balanced and do not produce forces).

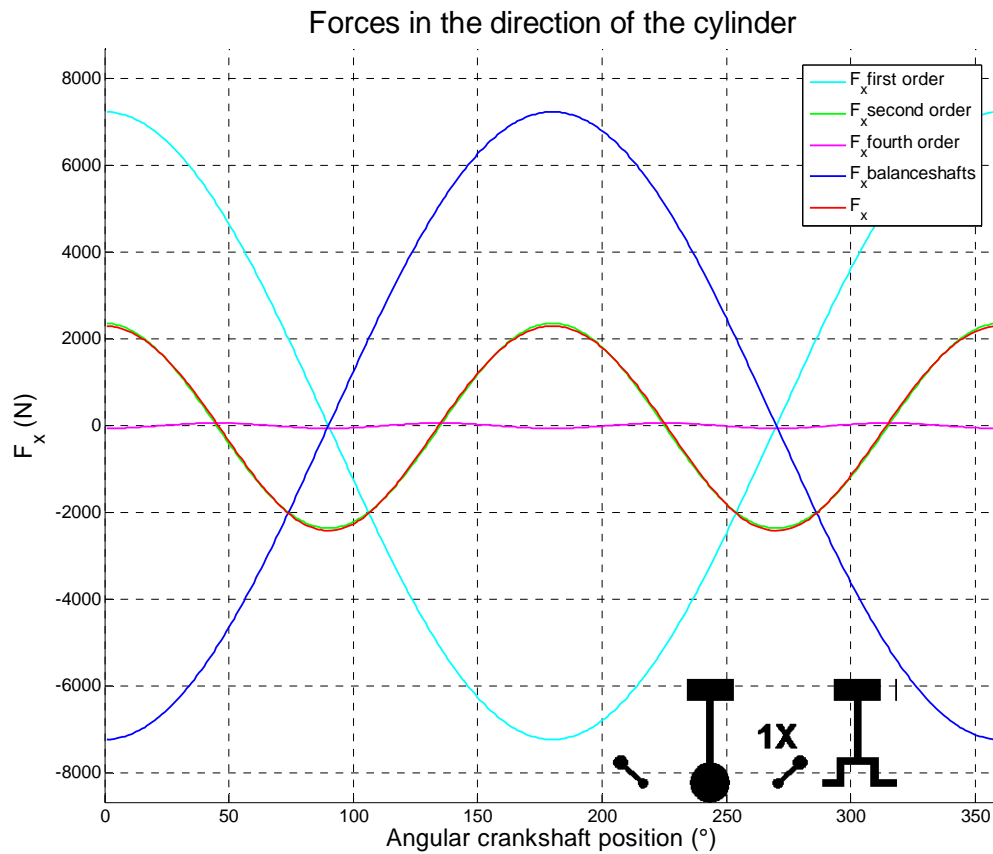
- Maximum force generated by the two balance shafts:  $F_x = 2 \cdot r_{bs} \cdot m_{bs} \cdot \omega^2$  (23)
- Maximum first order force generated by the cylinders:  $F_x = r \cdot \omega^2 \cdot m_o$  (24)

The equality between the equations (23) and (24) gives the equation (25) to calculate the unbalance mass of one balance shaft:

$$r_{bs} \cdot m_{bs} = \frac{r \cdot m_o}{2} \quad (25)$$

Finally, the value of the unbalance mass of one first order balance shaft is 0,020625 kg\*m for the position described previously. We notice from this reasoning that the balancing does not depend on the rotation speed.





**Figure 27: F<sub>x</sub> for shorter stroke single-cylinder engine with two first order balance shafts**

Figure 27 shows that the rotating forces produced by the balance shaft (dark blue line) are exactly the opposite of the engine first order forces (light blue line). The total force (red line) is the sum of the second and fourth order forces which are more or less equivalent to the second order force.

The force in the Y-direction is null so the resulting force is nearly equal to the second order force.

The summary of the key results is given in table 6.

$F_{x,max}$ (N)	2422,25
$F_{y,max}$ (N)	0,00
$F_{res,max}$ (N)	2422,25
$\Delta F_{res}$ (N)	2402,13
$M_{x,max}$ (Nm)	0,00
$M_{y,max}$ (Nm)	0,00
$M_{z,max}$ (Nm)	0,00
$M_{res,max}$ (Nm)	0,00
$\Delta M_{res}$ (Nm)	0,00

**Table 6: Maximum value of forces and moments for shorter stroke single-cylinder engine with two first order balance shafts**

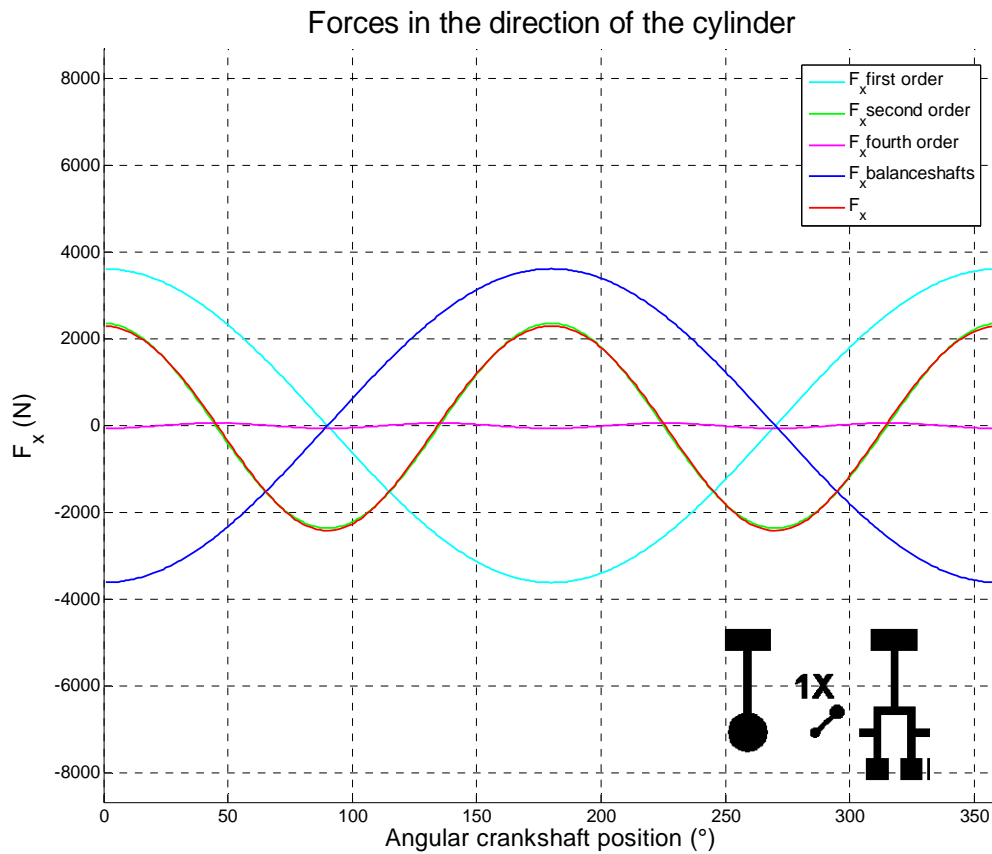
#### 4.2.3.2. Modified crankshaft + one first order balance shaft (case 4)

One alternative to the two first order balance shafts is to incorporate one balance shaft to the crankshaft. The unbalance mass of the balance shaft is added to the unbalance mass of the crank and only the counterrotative balance shaft is kept. By doing this, we use only one balance shaft, which reduces the complexity of the engine.

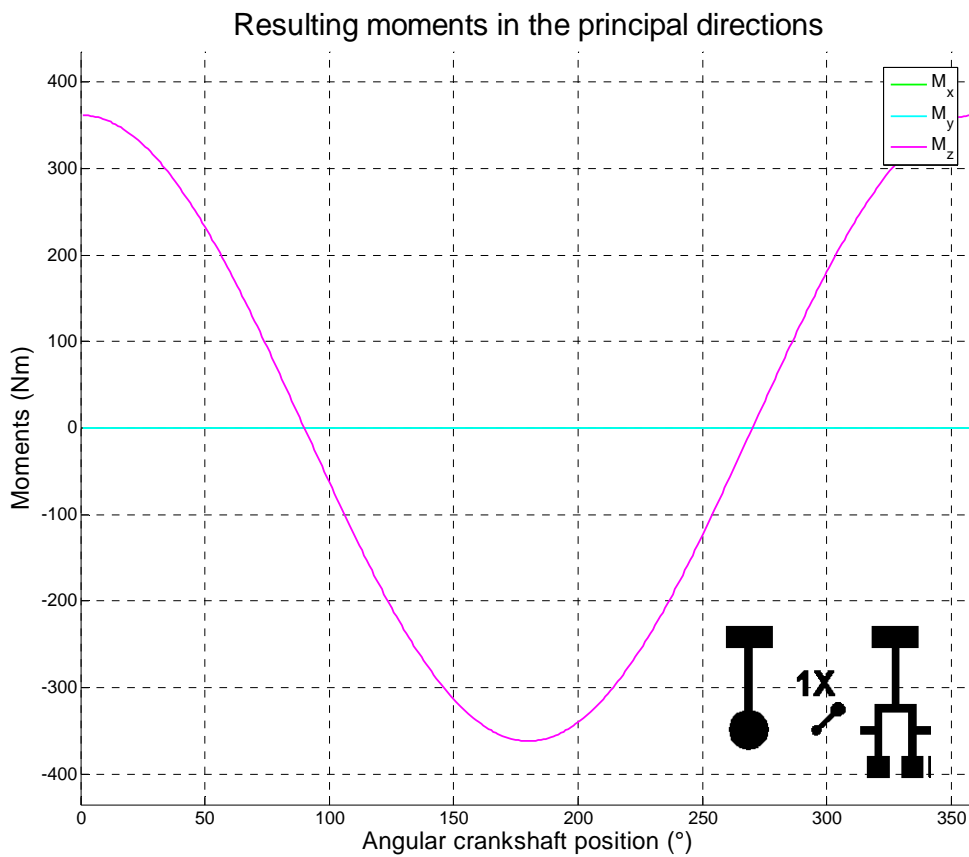
By comparison with figure 18, the figure 28 shows that the first order forces (light blue line) are reduced by the force of the crankshaft. And the remaining part of the first order is counteracted by the force of the single balance shaft (dark blue line).

The Y-force generated by the crankshaft is counteracted by the Y-force of the balance shaft. Since in this case, the balance shaft has the same X-coordinate than the crankshaft, the Y-forces are on the same line, they do not produce any moment around the Z-axis. But the X-forces are not on the same line, so they produce a Z-moment (figure 29).

With only one balance shaft, it is not possible to place it such as the X-forces and the Y-forces are both aligned in the same configuration. So *there is always a rolling moment with a single balance shaft*. Otherwise, all the results are the same than with two balance shafts (see table 7) with the advantage to have a less complex configuration.



**Figure 28:**  $F_x$  for shorter stroke single-cylinder engine with one first order balance shaft



**Figure 29:** Moments for shorter stroke single-cylinder engine with one first order balance shaft

$F_{x,max}$ (N)	2422,25
$F_{y,max}$ (N)	0,00
$F_{res,max}$ (N)	2422,25
$\Delta F_{res}$ (N)	2402,13
$M_{x,max}$ (Nm)	0,00
$M_{y,max}$ (Nm)	0,00
$M_{z,max}$ (Nm)	361,9
$M_{res,max}$ (Nm)	361,9
$\Delta M_{res}$ (Nm)	361,9

**Table 7: Maximum value of forces and moments for shorter stroke single-cylinder engine with one first order balance shaft**

#### 4.2.3.3. Optimized crankshaft + two second order balance shafts (case 5)

We have seen in figure 23 that when the value of the unbalance mass of the crankshaft is optimized, the second order force become an important part of the resulting force (nearly 50%). So we decide to compensate the entire second order force with two balance shafts rotating at twice the crankshaft speed. Nevertheless, as we reduce the X-force with the balance shafts, we need to calculate a new optimum value for the crankshaft with a parametric study.

- Maximum force generated by the two balance shafts:

$$F_x = 2 \cdot r_{bs} \cdot m_{bs} \cdot (2 \cdot \omega)^2 \quad (26)$$

- Maximum second order force generated by the cylinder:

$$F_x = r \cdot \omega^2 \cdot m_o \cdot A_2 \quad (27)$$

The equality between the equations (26) and (27) gives the relation (28) to calculate the unbalance mass of one balance shaft:

$$r_{bs} \cdot m_{bs} = \frac{r \cdot m_o \cdot A_2}{8} \quad (28)$$

Compared to the case with two first order balance shafts, we notice that the unbalance mass of the crank is smaller in this case, 0,04130 kg\*m instead of 0,04561 kg\*m. And the unbalance mass of one balance shaft is 0,00168 kg\*m. This value may seem small, compared to unbalance mass of one first order balance shaft (0,020625 kg\*m), but we have to keep in

mind that the balance shafts revolve at twice the crank speed. Since the force is proportional to the square of the rotating speed, when we double the speed, the force is multiplied by four.

Figure 30 shows that the force generated by the balance shafts is exactly the opposite of the second order force. So the total X-force is the sum of reduced first order force and negligible fourth order force.

Another advantage of this configuration is that the amplitude (modulus) of the resulting force is nearly constant (see figure 31).

Table 8 presents a summary of the key results.

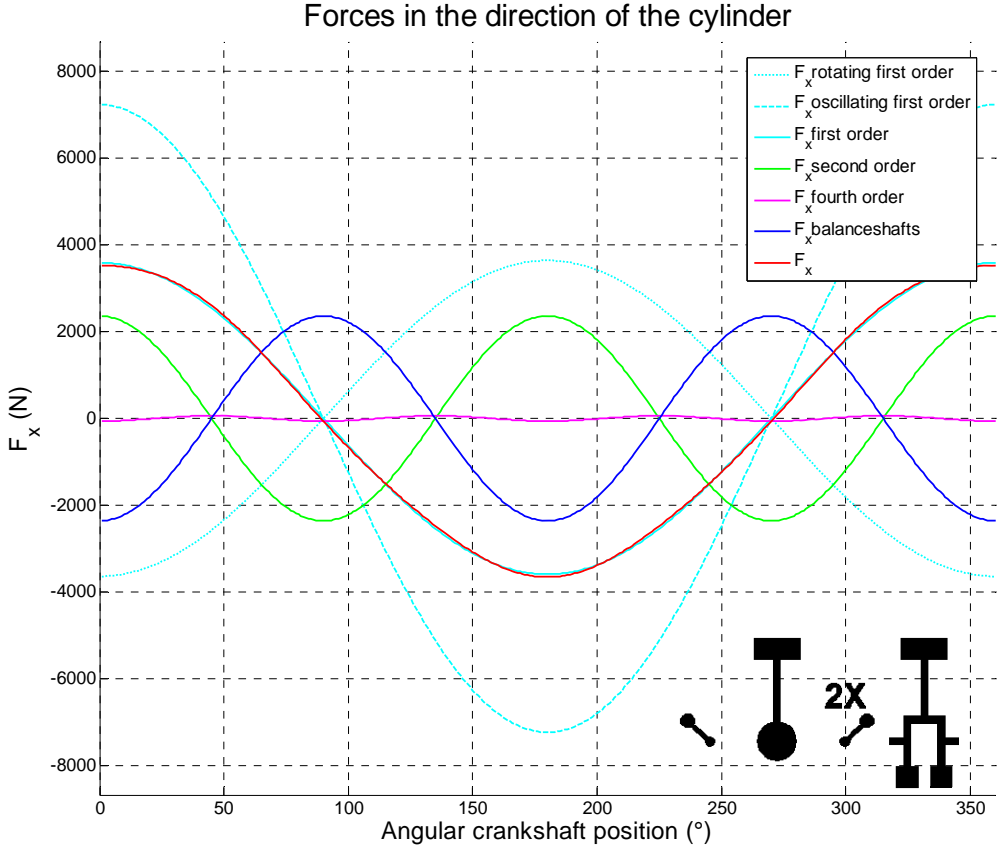
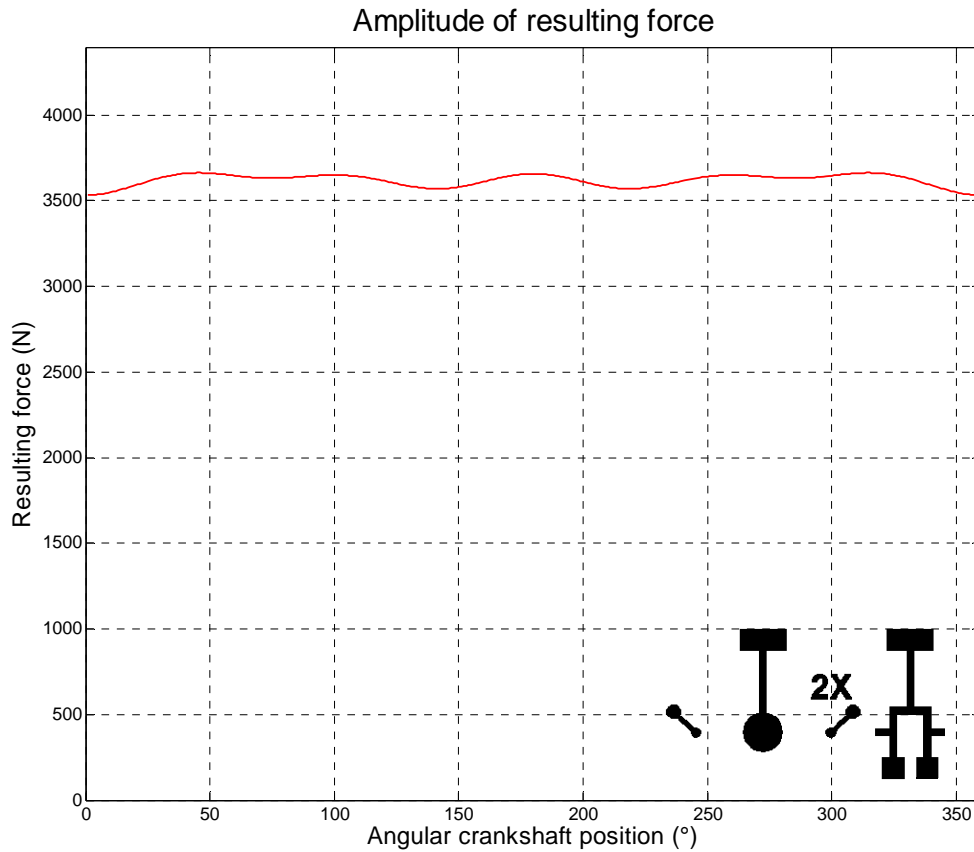


Figure 30:  $F_x$  for shorter stroke single-cylinder engine with two second order balance shafts



**Figure 31: F<sub>res</sub> for shorter stroke single-cylinder engine with two second order balance shafts**

$F_{x,max}$ (N)	3657,37
$F_{y,max}$ (N)	3643,02
$F_{res,max}$ (N)	3663,17
$\Delta F_{res}$ (N)	130,57
$M_{x,max}$ (Nm)	0,00
$M_{y,max}$ (Nm)	0,00
$M_{z,max}$ (Nm)	0,00
$M_{res,max}$ (Nm)	0,00
$\Delta M_{res}$ (Nm)	0,00

**Table 8: Maximum value of forces and moments for shorter stroke single-cylinder engine with two second order balance shafts**

#### 4.2.3.4. Modified crankshaft + one first order and one second order balance shaft (case 6)

Based on the case of the modified crankshaft and one first order balance shaft, we decide to add to this configuration (case 4) one single second order balance shaft to reduce the second

order force. By comparison with the case without the second order balance shaft, we notice a reduction of 50% of the resulting force but the price is an increase of 25% of the resulting moment (see table 9).

$F_{x,max}$ (N)	1242,32
$F_{y,max}$ (N)	1179,93
$F_{res,max}$ (N)	1242,32
$\Delta F_{res}$ (N)	124,77
$M_{x,max}$ (Nm)	0,00
$M_{y,max}$ (Nm)	0
$M_{z,max}$ (Nm)	479,89
$M_{res,max}$ (Nm)	479,89
$\Delta M_{res}$ (Nm)	479,58

**Table 9: Maximum value of forces and moments for shorter stroke single-cylinder engine with one first and one second order balance shafts**

#### 4.2.3.5. Three or four balance shafts

We also study some cases with more than two balance shafts. These configurations are more expensive and more difficult to design but they could lead to important reductions in resulting moments and forces.

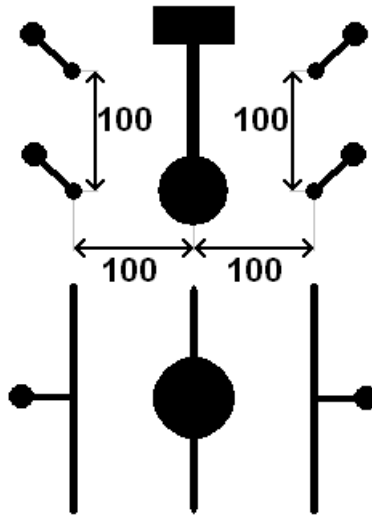
The first one continues along the former case (case 6) with two second order balance and one first order shafts (the second first order shaft is carried out using a modified balancing of the crankshaft) in order to suppress the entire second order force (case 7).

We are also interested in the case with two first order and one second order balance shafts (case 8).

Finally, the last case consists in two first order and two second order balance shafts, the first and second order forces are completely suppressed in this last case (case 9).

The balance shafts three and four are placed 100mm (arbitrary choice) above the two first balance shafts (see figure 32).

The values calculated for these three configurations are given in table 10.



**Figure 32: Position of the balance shafts 3 and 4 in the shorter stroke single-cylinder engine**

#### 4.2.4. Summary

All the different configurations studied for the shorter stroke single-cylinder engine are summarized in the table (table 10) and graphic (figure 33) below.

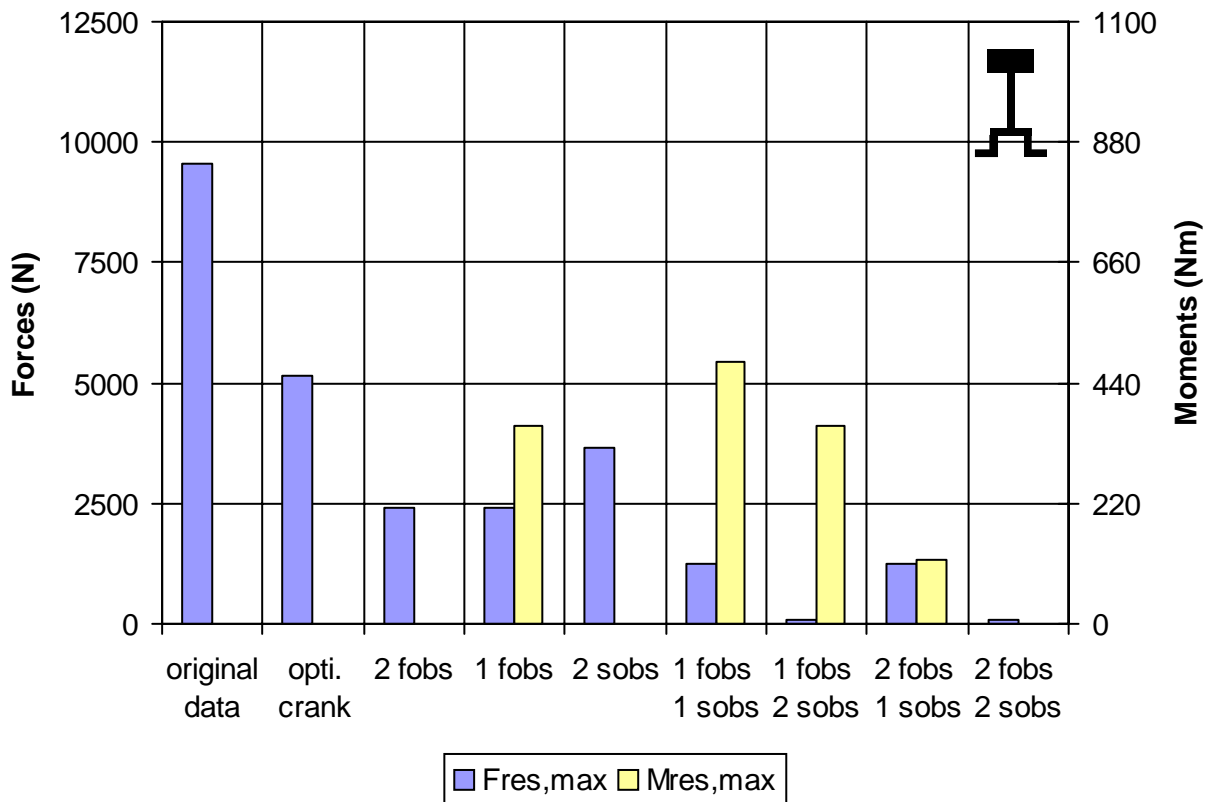
Here are a few remarks concerning the results presented in the table:

- The unbalance mass of the first order balance shafts (FOBS) is 0,020625 kg\*m.
- The unbalance mass of the second order balance shafts (SOBS) is 0,00168 kg\*m.
- The unbalance mass of the crankshaft is given in the table.



Case	1	2	3	4	5	6	7	8	9
Name	Basic	opti. crank	2FOBS	1FOBS	opti. c. 2SOBS	1FOBS 1SOBS	1FOBS 2SOBS	2FOBS 1SOBS	2FOBS 2SOBS
Crank (kg*m)	0,02054	0,04561	0,02054	0,04116	0,04130	0,04116	0,04116	0,02054	0,02054
$F_{x,max}$ (N)	9535	5136	2422	2422	3657	1242	63	1243	63
$F_{y,max}$ (N)	0	4399	0	0	3643	1180	0	1180	0
$F_{res,max}$ (N)	9535	5136	2422	2422	3663	1242	63	1243	63
$\Delta F_{res}$ (N)	4720	4595	2402	2402	131	125	61	125	61
$M_{x,max}$ (Nm)	0	0	0	0	0	0	0	0	0
$M_{y,max}$ (Nm)	0	0	0	0	0	0	0	0	0
$M_{z,max}$ (Nm)	0	0	0	362	0	480	362	118	0
$M_{res,max}$ (Nm)	0	0	0	362	0	480	362	118	0
$\Delta M_{res}$ (Nm)	0	0	0	362	0	480	362	118	0
Complexity	--	-	++	+	++	++	+++	+++	++++

**Table 10: Maximum values of forces and moments for different balancing systems of the shorter stroke single-cylinder engine rotating at 4000 rpm**



**Figure 33: Maximum values of resulting forces and moments for different balancing systems of the shorter stroke single-cylinder engine rotating at 4000 rpm**

### 4.3. Longer stroke single-cylinder engine

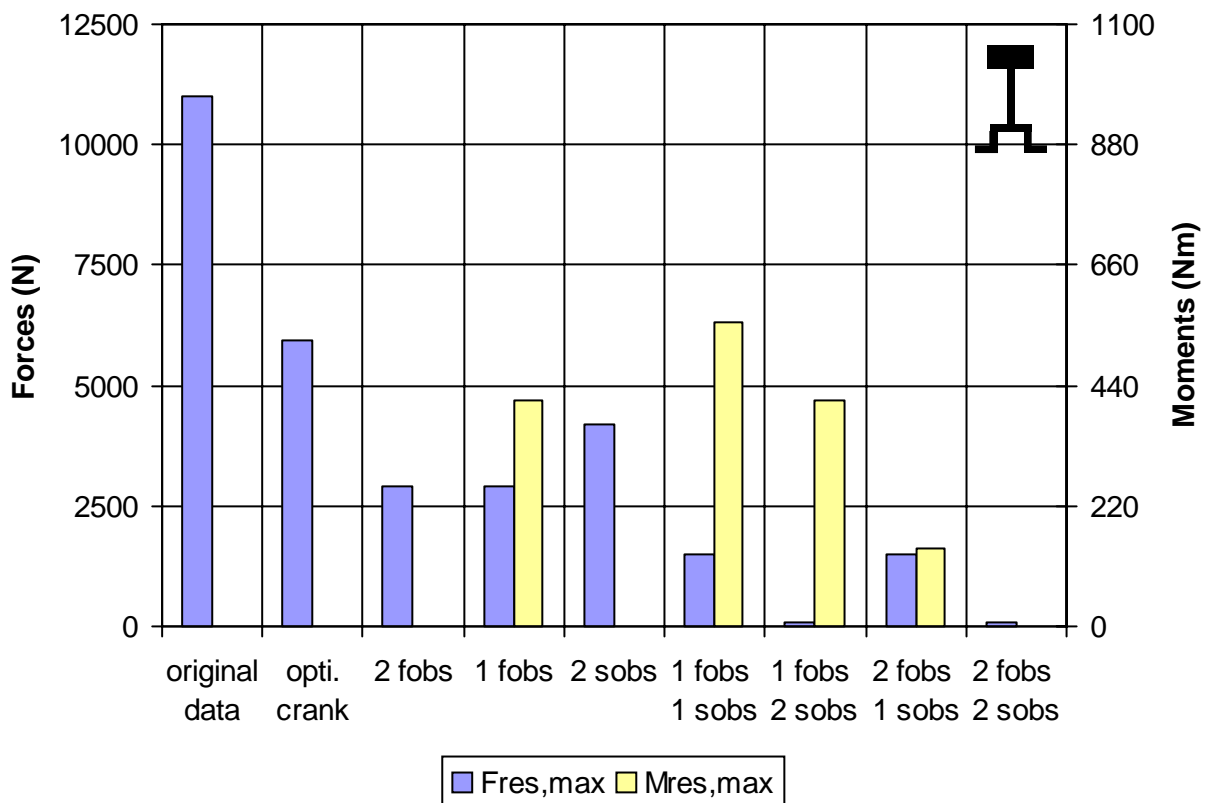
The engine with the longer stroke is characterized by a higher oscillating mass ( $0,985 \text{ kg} > 0,955 \text{ kg}$ ), a longer stroke ( $0,04775 \text{ m} > 0,0432 \text{ m}$ ) and a higher stroke to connecting rod ratio ( $0,3316 > 0,3176$ ) than the shorter stroke engine. So the forces generated by the longer stroke engine are a little higher than the forces of the shorter stroke engine even if they have the same aspect for the same configuration of engine. Thus, we do not describe once again all results and figures; we only give the final results (table 11) and graphic (figures 34).

Here are a few remarks concerning the results presented in the table:

- The unbalance mass of the first order balance shafts (FOBS) is  $0,02352 \text{ kg}\cdot\text{m}$ .
- The unbalance mass of the second order balance shafts (SOBS) is  $0,00201 \text{ kg}\cdot\text{m}$ .
- The unbalance mass of the crankshaft is given in the table.

Case	1	2	3	4	5	6	7	8	9
Name	Basic	opti. crank	2FOBS	1FOBS	opti. c. 2SOBS	1FOBS 1SOBS	1FOBS 2SOBS	2FOBS 1SOBS	2FOBS 2SOBS
Crank (kg*m)	0,02001	0,04875	0,02001	0,04353	0,04371	0,04353	0,04353	0,02001	0,02001
Fx,max (N)	10987	5945	2897	2897	4176	1489	82	1489	82
Fy,max (N)	0	5042	0	0	4158	1408	0	1408	0
Fres,max (N)	10987	5945	2897	2897	4184	1489	82	1489	82
$\Delta$ Fres (N)	10939	5469	2880	2880	171	163	79	163	79
Mx,max (Nm)	0	0	0	0	0	0	0	0	0
My,max (Nm)	0	0	0	0	0	0	0	0	0
Mz,max (Nm)	0	0	0	413	0	554	413	141	0
Mres,max (Nm)	0	0	0	413	0	554	413	141	0
$\Delta$ Mres (Nm)	0	0	0	413	0	550	413	141	0
Complexity	--	-	++	+	++	++	+++	+++	++++

**Table 11: Maximum values of forces and moments for different balancing systems of the longer stroke single-cylinder engine rotating at 4000 rpm**



**Figure 34: Maximum values of resulting forces for different balancing systems of the longer stroke single-cylinder engine rotating at 4000 rpm**

## 4.4. Shorter stroke twin-cylinder in-line engine, in-phase arrangement

We focus now on the **twin-cylinder engine** and we begin with the shorter stroke in-line engine with in-phase arrangement of the crankshaft. As noticed in a first analysis, we expect to note that the forces generated by the complete engine are the double of the forces generated by the single-cylinder engine. So it means that forces of all orders (first, second, fourth...) are not null. And as the pistons move in phase and in the same direction, there is no moment generated.

### 4.4.1. Reference data (case 1)

We look at the basic configuration of the engine, with no balance shaft and a well-balanced crankshaft. This means that the crankshaft and the related part of the connecting rod produce no forces. We focus mainly on the forces in the direction of the piston motion (figure 35).

We notice that the shapes of the forces curves are exactly the same than the curves of the single-cylinder engine (see figure 18). But the values are doubled, the maximum value of the force  $F_x$  is 19071 N instead of 9535,5 N for the single-cylinder engine.

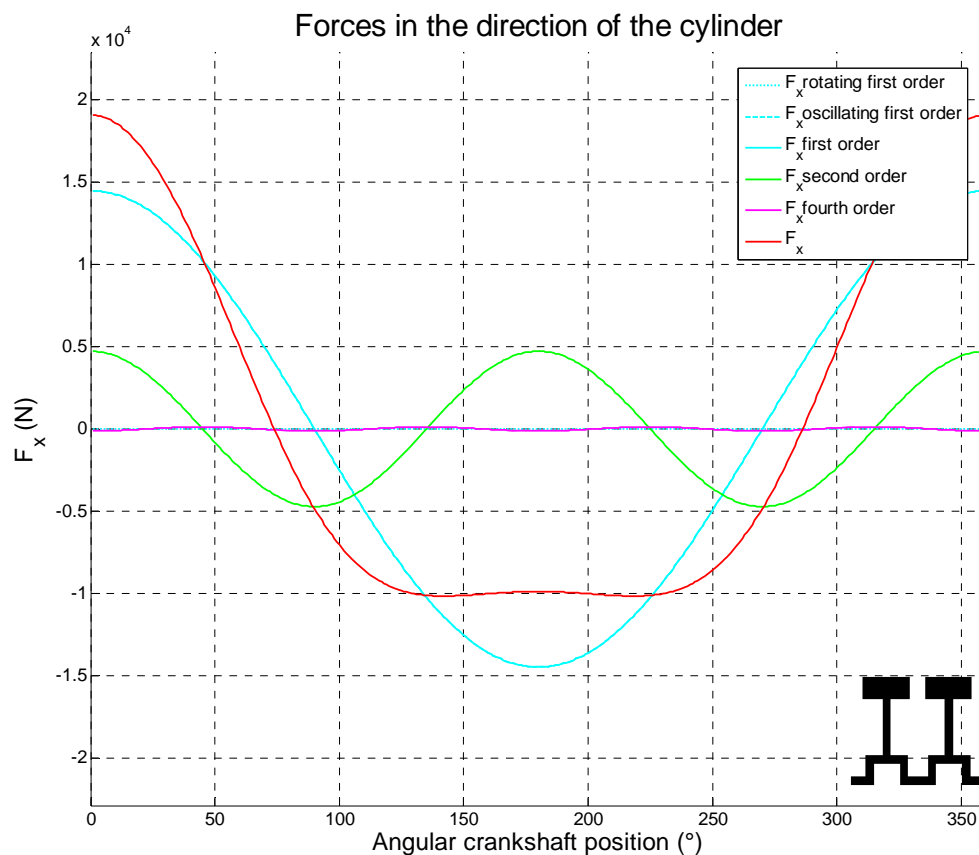


Figure 35:  $F_x$  for shorter stroke twin-cylinder in-phase in-line engine rotating at 4000 rpm

Table 12 presents a summary of the maximum values obtained for the principal forces and moments.  $\Delta F_{res}$  and  $\Delta M_{res}$  are the variations between the maximum and minimum value of  $F_{res}$  or  $M_{res}$ .

$F_{x,max}$ (N)	19070,98
$F_{y,max}$ (N)	0,00
$F_{res,max}$ (N)	19070,98
$\Delta F_{res}$ (N)	19003,85
$M_{x,max}$ (Nm)	0,00
$M_{y,max}$ (Nm)	0,00
$M_{z,max}$ (Nm)	0,00
$M_{res,max}$ (Nm)	0,00
$\Delta M_{res}$ (Nm)	0,00

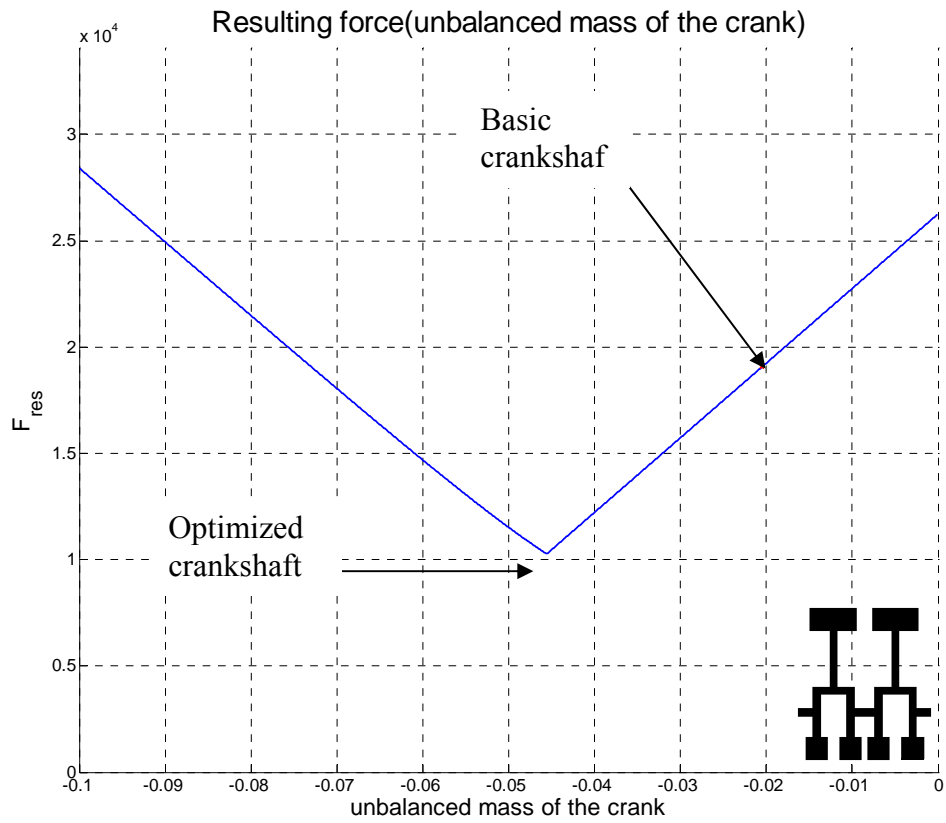
**Table 12: Maximum values of forces and moments for shorter stroke in-phase in-line twin-cylinder engine at 4000 rpm**

The in-phase in-line engine is characterized by important forces (19070 N) of first, second and higher orders like the single-cylinder engine. In this case, the force is in pure X-direction; there is no effect in Y-direction due to the balancing of the crankshaft. One major advantage of this configuration is that there is no resulting moments in any direction.

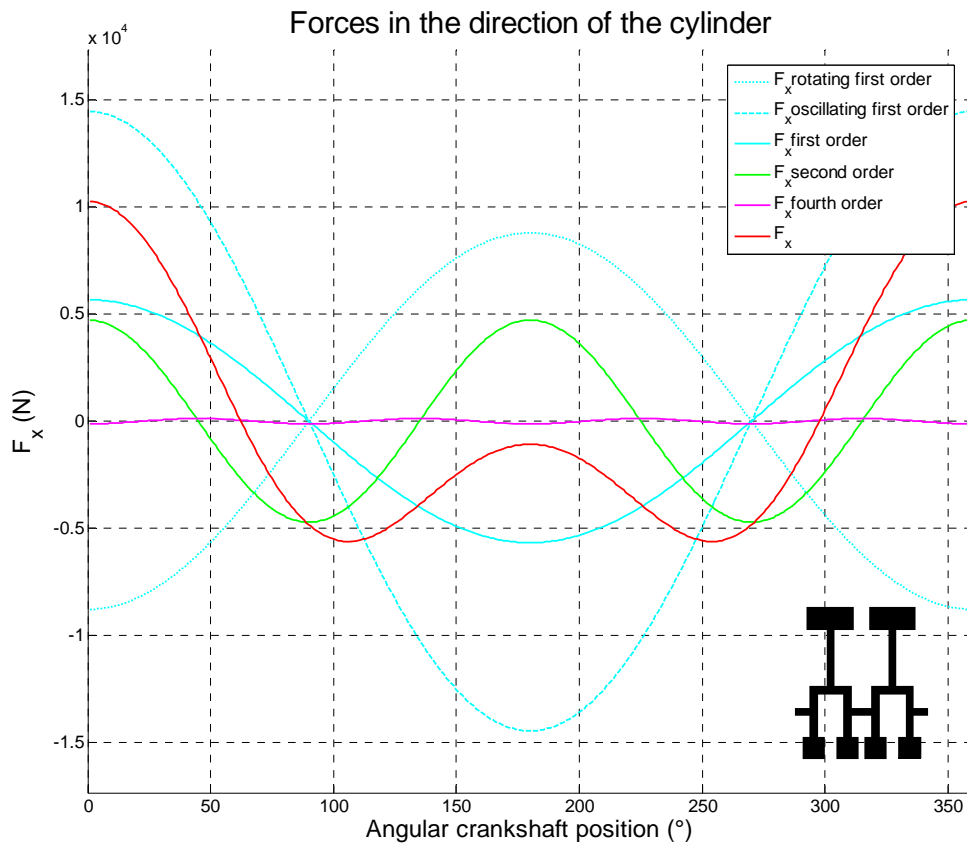
#### 4.4.2. Optimization of the crankshaft (case 2)

We try here to decrease the important X-forces of the basic configuration by a proper choice of the crankshaft counterweights. Using a parametric study, we look for the value of the unbalance mass of the crankshaft that minimizes the maximum resulting force ( $F_{res}$ ). In figure 36, the red point indicates the reference value of the crankshaft. This means that an appropriate choice of counterweight can nearly divide by two the maximum resulting force.

Figure 37 shows that, compared with figure 35, the oscillating first order, the second order and fourth order forces are not modified. Only the rotating first order forces (dotted light blue line) have been modified and therefore the total first order force and total force in the X-direction. We notice that the maximum value of the oscillating force is a little higher than the maximum value of the rotating force but with a phase shift of  $180^\circ$  (principle of the counterweight). So the first order forces are reduced from 14476,1 N to 5677,5 N which is a decrease of 61%. When considering also the high order forces, one notices that the maximum value of the total force decreases from 19071 N to 10272,5 N, which is a decrease of 46% and the maximum negative value also decreases in the same proportion.



**Figure 36: Minimization of  $F_{res}$  by variation of the unbalance mass of the crank for the shorter stroke in-phase in-line twin-cylinder engine**



**Figure 37:  $F_x$  for optimized shorter stroke in-phase in-line twin-cylinder engine**

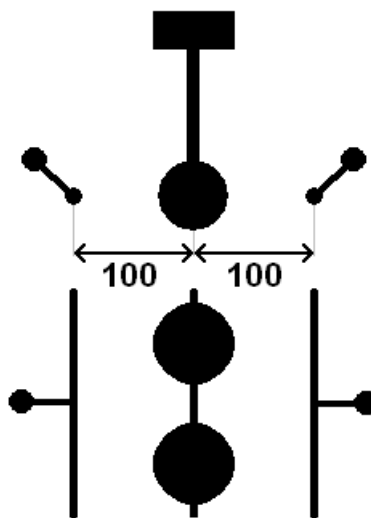
Table 13 presents a summary of the key results.

$F_{x,max}$ (N)	10272,48
$F_{y,max}$ (N)	8798,50
$F_{res,max}$ (N)	10272,58
$\Delta F_{res}$ (N)	9190,04
$M_{x,max}$ (Nm)	0,00
$M_{y,max}$ (Nm)	0,00
$M_{z,max}$ (Nm)	0,00
$M_{res,max}$ (Nm)	0,00
$\Delta M_{res}$ (Nm)	0,00

**Table 13: Maximum values of forces and moments for optimized shorter stroke in-phase in-line twin-cylinder engine**

#### 4.4.3. Balance shafts

In this section, we try different associations of balance shafts and crankshaft for the in-phase in-line twin-cylinder engine. The position of the balance shafts is very important, especially if we use only one balance shaft. If the balance shafts are not well placed, they will produce forces that are not aligned with the forces of the pistons and the crankshaft and it will generate free moments. We choose to place the balance shafts in the same horizontal plane than the crankshaft at 100 mm on each side of the cylinder plane (see figure38). The balance shafts have to be placed symmetrically with respect to the cylinder row in order to produce no rolling moment. Lengthways, they are positioned at the middle of the engine to avoid free pitching or yawing moments.



**Figure 38: Position of the balance shafts in the twin-cylinder engine**

#### 4.4.3.1. Basic crankshaft + two first order balance shafts (case 3)

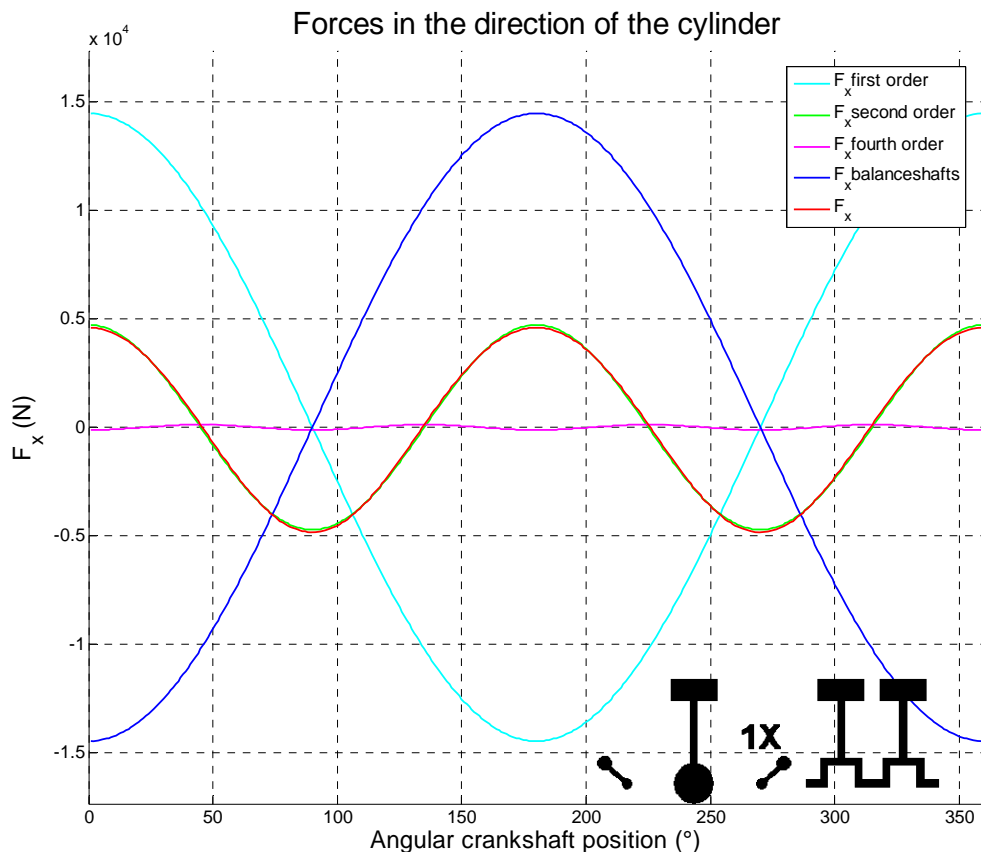
We use in this configuration two balance shafts revolving at 4000 rpm to balance first order X-force. The maximum X-force generated by the two balance shafts has to compensate the maximum first order X-force generated by the oscillating parts of the two cylinders (the rotating parts are already balanced and do not produce forces).

- Maximum force generated by the two balance shafts:  $F_x = 2 \cdot r_{bs} \cdot m_{bs} \cdot \omega^2$  (29)
- Maximum first order force generated by the two cylinders:  $F_x = 2 \cdot r \cdot \omega^2 \cdot m_o$  (30)

The equality between the equations (29) and (30) gives the equation (31) to calculate the unbalance mass of one balance shaft:

$$r_{bs} \cdot m_{bs} = r \cdot m_o \quad (31)$$

Finally, the value of the unbalance mass of a first order balance shaft is 0,04125 kg\*m for the position described previously. We notice that in this approach the balancing does not depend on the rotation speed.



**Figure 39: Fx for shorter stroke in-phase in-line twin-cylinder engine with two first order balance shafts**

Figure 39 shows that the rotating forces produced by the balance shaft (dark blue line) are exactly the opposite of the engine first order forces (light blue line). The total force (red line) is the sum of the second and fourth order forces which is more or less equivalent to the second order force.



The summary of the key results is given in table 14.

$F_{x,max}$ (N)	4844,51
$F_{y,max}$ (N)	0,00
$F_{res,max}$ (N)	4844,51
$\Delta F_{res}$ (N)	4804,66
$M_{x,max}$ (Nm)	0,00
$M_{y,max}$ (Nm)	0,00
$M_{z,max}$ (Nm)	0,00
$M_{res,max}$ (Nm)	0,00
$\Delta M_{res}$ (Nm)	0,00

**Table 14: Maximum value of forces and moments for shorter stroke in-phase in-line twin-cylinder engine with two first order balance shafts**

#### 4.4.3.2. Optimized crankshaft + two second order balance shafts (case 5)

We decide to compensate the entire second order force with two balance shafts rotating at twice the crankshaft speed. Nevertheless, as we reduce the X-force with the balance shafts, we need to calculate a new optimum value for the crankshaft with a new parametric study.

- Maximum force generated by the two balance shafts:

$$F_x = 2 \cdot r_{bs} \cdot m_{bs} \cdot (2 \cdot \omega)^2 \quad (32)$$

- Maximum second order force generated by the two cylinders:

$$F_x = 2 \cdot r \cdot \omega^2 \cdot m_o \cdot A_2 \quad (33)$$

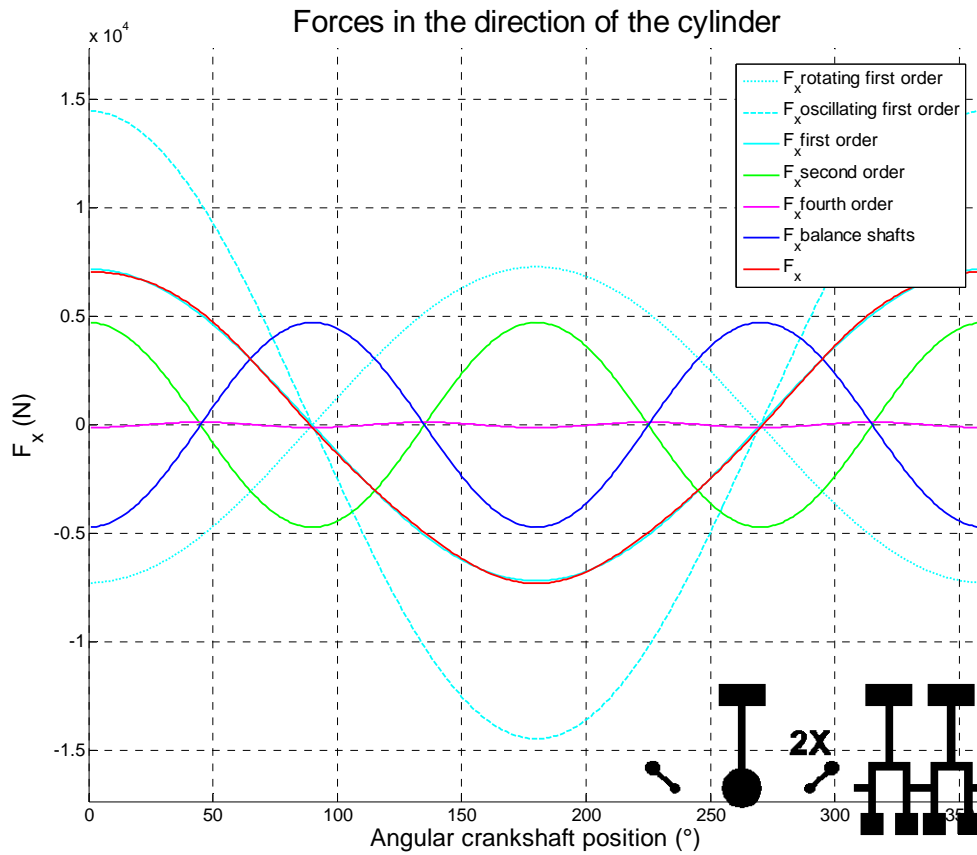
The equality between the equations (32) and (33) gives one relation (34) to calculate the unbalance mass of one balance shaft:

$$4 \cdot r_{bs} \cdot m_{bs} = r \cdot m_o \cdot A_2 \quad (34)$$

Compared to the case with two first order balance shafts, we notice that the unbalance mass of one half crank is smaller in this case, 0,04130 kg\*m instead of 0,04561 kg\*m. And the unbalance mass of one balance shaft is 0,00336 kg\*m..

Figure 40 shows that the force generated by the balance shafts is exactly the opposite of the second order force. So the total X-force is the sum of reduced first order force and negligible fourth order force.

Table 15 presents a summary of the key results.



**Figure 40:  $F_x$  for shorter stroke in-phase in-line twin-cylinder engine with two second order balance shafts**

$F_{x,max}$ (N)	7314,72
$F_{y,max}$ (N)	7286,04
$F_{res,max}$ (N)	7326,34
$\Delta F_{res}$ (N)	261,12
$M_{x,max}$ (Nm)	0,00
$M_{y,max}$ (Nm)	0,00
$M_{z,max}$ (Nm)	0,00
$M_{res,max}$ (Nm)	0,00
$\Delta M_{res}$ (Nm)	0,00

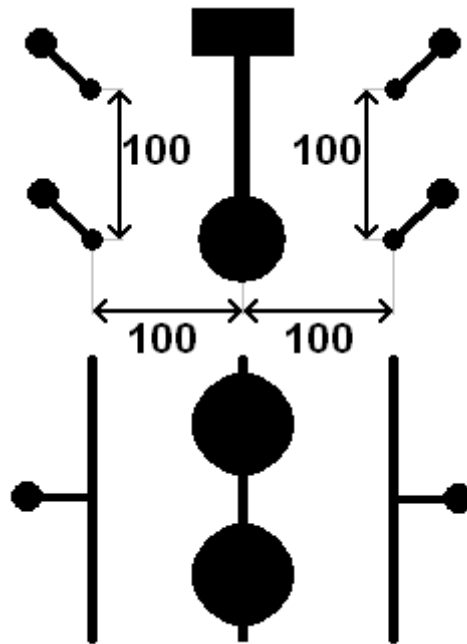
**Table 15: Maximum value of forces and moments for shorter stroke in-phase in-line twin-cylinder engine with two second order balance shafts**

#### 4.4.3.3. Three or four balance shafts

We also study some cases with more than two balance shafts. These configurations are more expensive and more difficult to design but they could lead to important reductions in resulting moments and forces.

The balance shafts three and four are placed 100mm above the two first balance shafts (see figure 41).

The values calculated for these three configurations are given in table 16.



**Figure 41: Position of the balance shafts three and four in the twin-cylinder engine**

#### 4.4.4. Summary

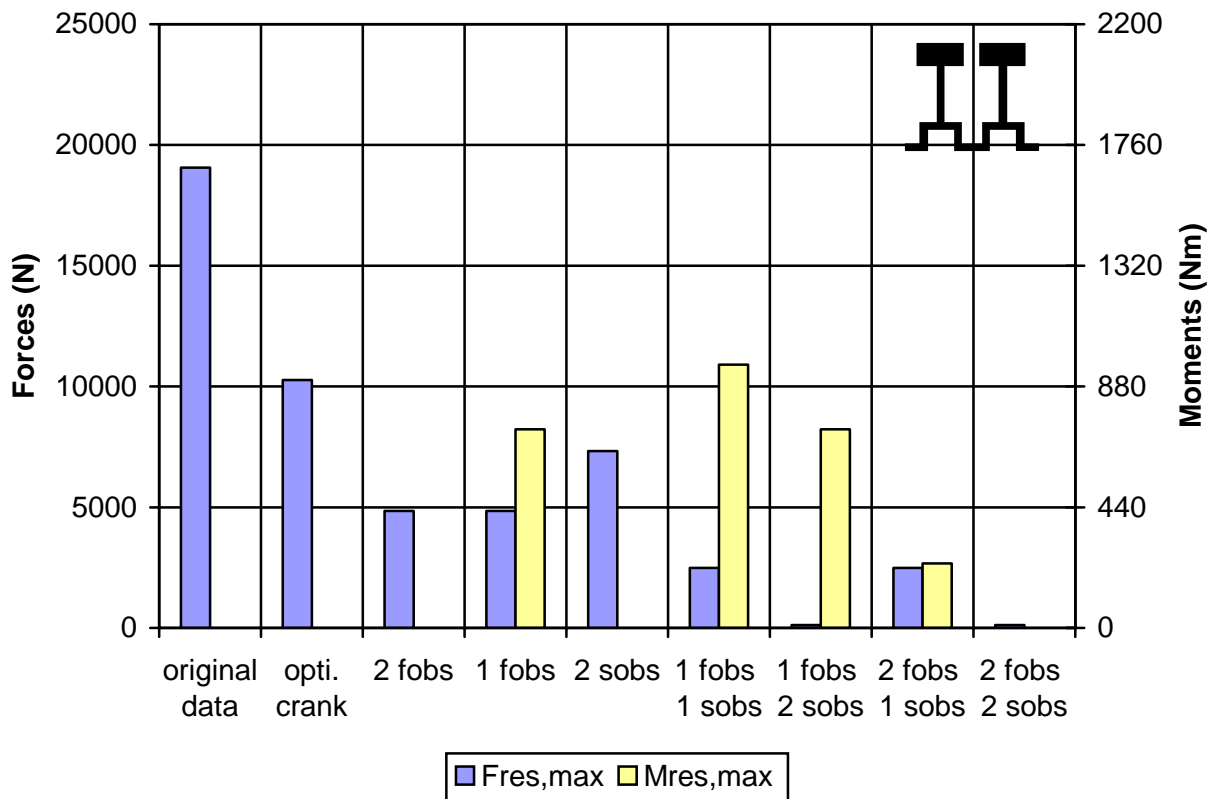
All the different configurations studied for the shorter stroke in-phase in-line engine are summarized in the table (table 16) and graphic (figure 42) below.

Here are a few remarks concerning the results presented in the table:

- The unbalance mass of the first order balance shafts (FOBS) is 0,04125 kg\*m.
- The unbalance mass of the second order balance shafts (SOBS) is 0,00336 kg\*m.
- The unbalance mass of the crankshaft is given in the table but it is the value for one half crankshaft (this value has to be doubled for the entire crankshaft).

Case	1	2	3	4	5	6	7	8	9
Name	Basic	opti. crank	2FOBS	1FOBS	opti. c. 2SOBS	1FOBS 1SOBS	1FOBS 2SOBS	2FOBS 1SOBS	2FOBS 2SOBS
Crank (kg*m)	0,02054	0,04561	0,02054	0,04116	0,04130	0,04116	0,04116	0,02054	0,02054
$F_{x,max}$ (N)	19071	10272	4845	4845	7315	2485	125	2485	125
$F_{y,max}$ (N)	0	8799	0	0	7286	2360	0	2360	0
$F_{res,max}$ (N)	19071	10273	4845	4845	7326	2485	125	2485	125
$\Delta F_{res}$ (N)	19004	9190	4805	4805	261	250	122	250	122
$M_{x,max}$ (Nm)	0	0	0	0	0	0	0	0	0
$M_{y,max}$ (Nm)	0	0	0	0	0	0	0	0	0
$M_{z,max}$ (Nm)	0	0	0	724	0	960	724	236	0
$M_{res,max}$ (Nm)	0	0	0	724	0	960	724	236	0
$\Delta M_{res}$ (Nm)	0	0	0	724	0	959	724	236	0
Complexity	--	-	++	+	++	++	+++	+++	++++

**Table 16: Maximum values of forces and moments for different balancing systems of the shorter stroke in-phase in-line twin-cylinder engine rotating at 4000 rpm**



**Figure 42: Maximum values of resulting forces and moments for different balancing systems of the shorter stroke in-phase in-line twin-cylinder engine rotating at 4000 rpm**

## 4.5. Longer stroke twin-cylinder in-line engine, in-phase arrangement

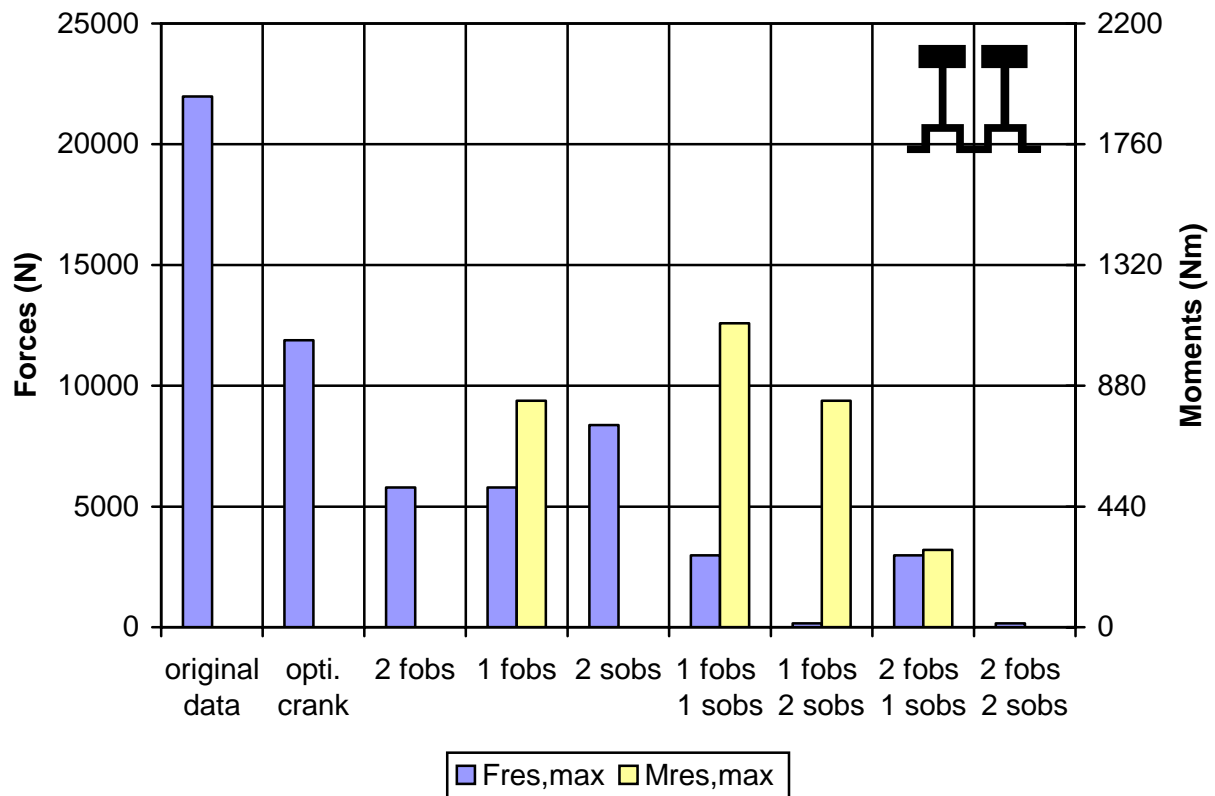
The forces generated by the longer stroke engine are a little higher than the force of the shorter stroke engine even if they have the same aspect for the same configuration of engine and balancing system. Thus, we do not describe once again all figures; we only give the final results table (table 17) and graphic (figures 43).

Here are a few remarks concerning the results presented in the table:

- The unbalance mass of the first order balance shafts (FOBS) is 0,04703 kg\*m.
- The unbalance mass of the second order balance shafts (SOBS) is 0,00401 kg\*m.
- The unbalance mass of the crankshaft is given in the table but it is the value for one half crankshaft (this value has to be doubled for the entire crankshaft).

Case	1	2	3	4	5	6	7	8	9
Name	Basic	opti. crank	2FOBS	1FOBS	opti. c. 2SOBS	1FOBS 1SOBS	1FOBS 2SOBS	2FOBS 1SOBS	2FOBS 2SOBS
Crank (kg*m)	0,02001	0,04875	0,02001	0,04353	0,04371	0,04353	0,04353	0,02001	0,02001
$F_{x,max}$ (N)	21973	11889	5794	5794	8352	2978	163	2978	163
$F_{y,max}$ (N)	0	10084	0	0	8316	2816	0	2816	0
$F_{res,max}$ (N)	21973	11889	5794	5794	8368	2978	163	2978	163
$\Delta F_{res}$ (N)	21877	10937	5760	5760	341	326	157	326	157
$M_{x,max}$ (Nm)	0	0	0	0	0	0	0	0	0
$M_{y,max}$ (Nm)	0	0	0	0	0	0	0	0	0
$M_{z,max}$ (Nm)	0	0	0	825	0	1107	825	282	0
$M_{res,max}$ (Nm)	0	0	0	825	0	1107	825	282	0
$\Delta M_{res}$ (Nm)	0	0	0	825	0	1099	825	282	0
Complexity	--	-	++	+	++	++	+++	+++	++++

**Table 17: Maximum values of forces and moments for different balancing systems of the longer stroke in-phase in-line twin-cylinder engine rotating at 4000 rpm**



**Figure 43: Maximum values of resulting forces for different balancing systems of the longer stroke in-phase in-line twin-cylinder engine rotating at 4000 rpm**

## 4.6. Shorter stroke twin-cylinder in-line engine, out-of-phase arrangement

We investigate now the second arrangement of the crankshaft, the out-of-phase configuration of the in-line engine. As pointed out in the modeling section, we expect that the first order forces are canceled and that there are free moments due to the misalignment of the forces.

As for the in-phase arrangement, we proceed by studying the behavior of the engine rotating at 4000 rpm with the reference data, then we optimize the crankshaft and we finish by calculating different configurations of crank and balance shafts.

### 4.6.1. Reference data (case 1)

Figure 44 shows that the first order forces are equal to zero and the total X-force are the sum of the second and fourth order forces (as in the case of the in-phase in-line engine with two first order balance shafts). We notice also that the main disadvantage of this configuration is that the opposite motion of the pistons produces a **first order moment around the Y-axis** (see figure 45). All the maximum values of forces and moments are given in table 18.

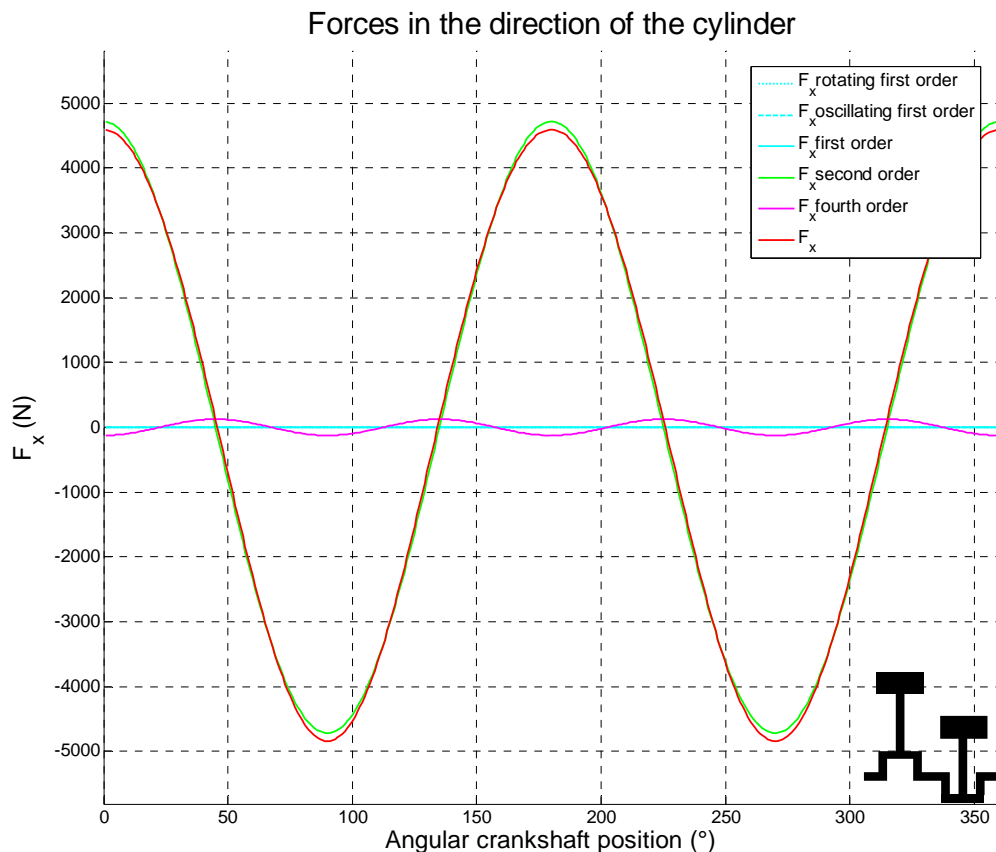
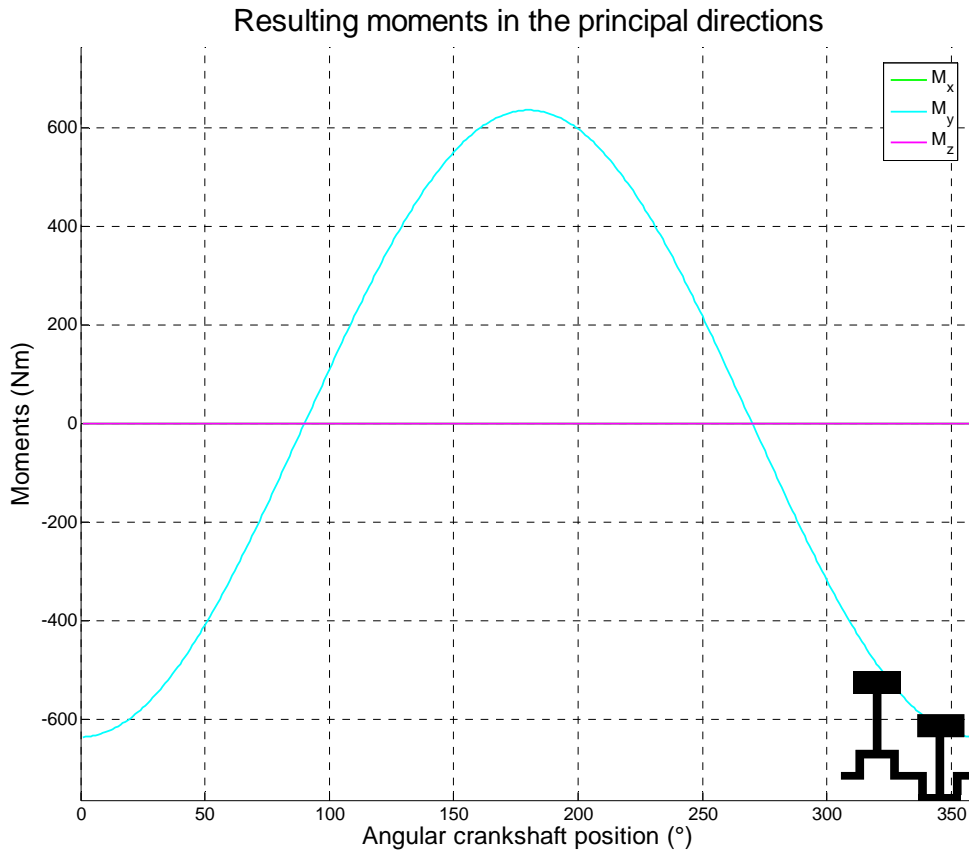


Figure 44:  $F_x$  for shorter stroke out-of-phase in-line twin-cylinder engine



**Figure 45: Moments for shorter stroke out-of-phase in-line twin-cylinder engine**

$F_{x,max}$ (N)	4844,51
$F_{y,max}$ (N)	0,00
$F_{res,max}$ (N)	4844,51
$\Delta F_{res}$ (N)	4804,25
$M_{x,max}$ (Nm)	0,00
$M_{y,max}$ (Nm)	636,94
$M_{z,max}$ (Nm)	0,00
$M_{res,max}$ (Nm)	636,94
$\Delta M_{res}$ (Nm)	636,94

**Table 18: Maximum values of forces and moments for shorter stroke out-of-phase in-line twin-cylinder engine**

#### 4.6.2. Optimization of the crankshaft (case 2)

As the first order forces are already equal to zero, we modify, in a parametric study, the counterweight in order to minimize the moments (see figure 46). We notice, in table 19, that



the pitching moment is reduced from 637 Nm to 318,5 Nm i.e. 50% but the yaw moment has increased from 0 to 318,5 Nm. Nevertheless, as yaw and pitch moments have a phase shift of 90°, the amplitude of the resulting moment is nearly constant and equal to 318,5 Nm. To reach this important reduction of moments, the unbalance mass of one half of the crank has been modified to 0,04116 kg\*m instead of 0,02054 kg\*m.

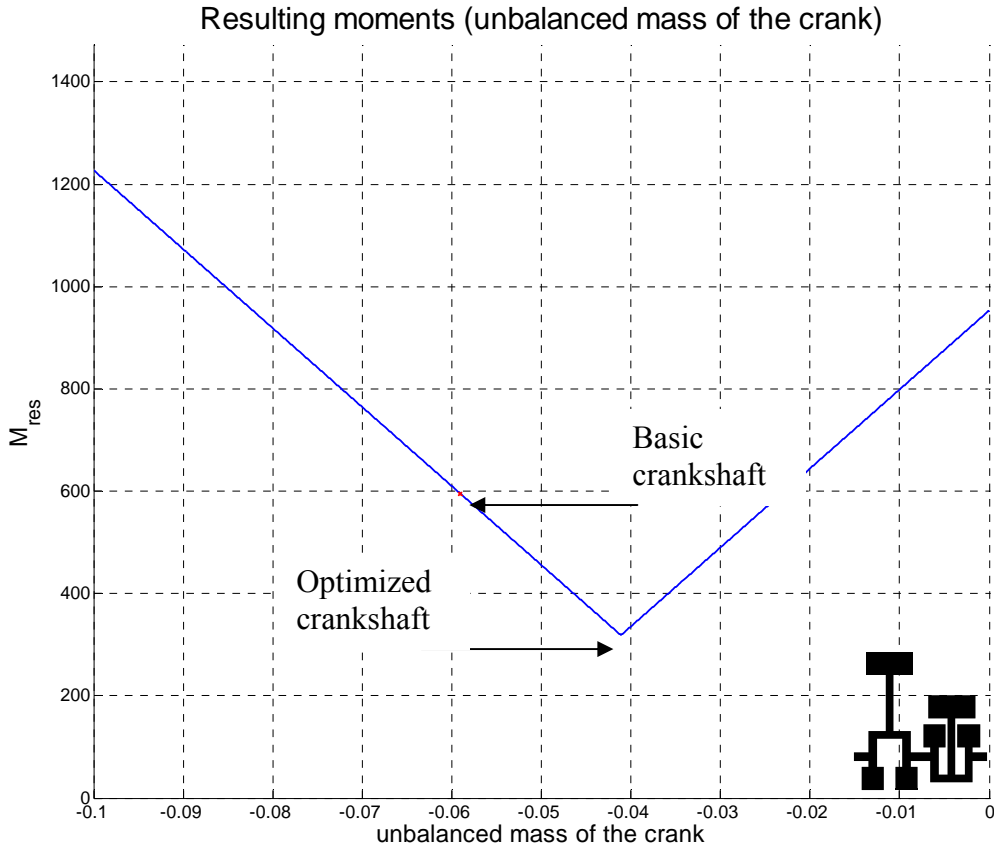


Figure 46: Minimization of  $M_{res}$  by variation of the unbalance mass of the crank

$F_{x,max}$ (N)	4844,51
$F_{y,max}$ (N)	0,00
$F_{res,max}$ (N)	4844,51
$\Delta F_{res}$ (N)	4804,25
$M_{x,max}$ (Nm)	318,42
$M_{y,max}$ (Nm)	318,52
$M_{z,max}$ (Nm)	0,00
$M_{res,max}$ (Nm)	318,52
$\Delta M_{res}$ (Nm)	0,10

Table 19: Maximum values of forces and moments for optimized shorter stroke out-of-phase in-line twin-cylinder engine

### 4.6.3. Balance shafts

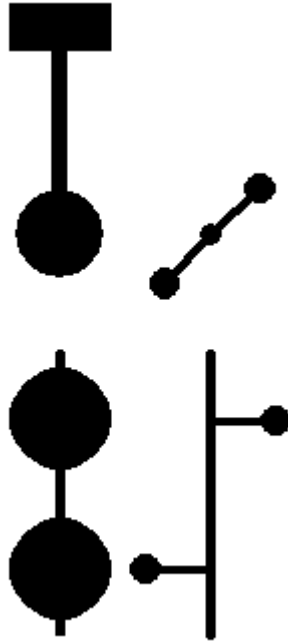
In this section, we try different combination of balance shafts and crankshaft to the twin-cylinder in-line out-of-phase engine. We investigate the same or nearly equivalent configurations than for the in-phase engine, so we keep the same case numbering.

#### 4.6.3.1. Optimized crankshaft + one first order double balance shaft (case 4)

The first configuration that we have tested for the in-phase engine was the two first order balance shafts that compensate the first order X-force (case 3). For the out-of-phase engine, the first order force is already balanced but a first order pitching moment exists.

So, we decide to find a configuration with two first order balance shafts that can counteract this pitching moment (around the Y-axis). To create an opposed pitching moment, the Z-coordinate of the two balance shafts has to be different. We want also that the balance shafts do not produce any new resulting forces, so that the forces generated by each shafts have to be opposed for every positions of the crankshaft. So the two balance shafts have to rotate in the same direction and to be out-of-phase. The problem with the two shafts rotating in the same direction is that they create a rolling moment unless they are on the same axis parallel to the crankshaft (the position of this axis has no influence on the moments).

So instead of having two counterrotative balance shafts, we design a unique shaft with two opposed unbalance masses (see figure 47). The Z-positions and the value of the unbalance masses are the factors that specify the values of the produced moments. This configuration of balance shaft creates a pitching moment without rolling moment and forces but there is an undesired yaw moment that is created. Nevertheless, we remember that with the optimized crankshaft, we have a yaw and a pitching moment of equal values. So we decide to apply our double balance shaft to the engine with the optimized crankshaft. The results are presented in table 20. Another solution could be using a second counterrotative double balance shaft [SWOBODA 1984, pp. 280], but it's a more expensive solution that leads to the same results (case 3). In fact, in our solution, the unbalance masses of the second double balance shaft are incorporated to the unbalance masses of the crankshaft.



**Figure 47: Design of the double balance shaft**

$F_{x,max}$ (N)	4844,51
$F_{y,max}$ (N)	0,00
$F_{res,max}$ (N)	4844,51
$\Delta F_{res}$ (N)	4804,25
$M_{x,max}$ (Nm)	0,04
$M_{y,max}$ (Nm)	0,06
$M_{z,max}$ (Nm)	0,00
$M_{res,max}$ (Nm)	0,06
$\Delta M_{res}$ (Nm)	0,03

**Table 20: Maximum values of forces and moments for optimized shorter stroke out-of-phase in-line twin-cylinder engine with one double first order balance shaft**

#### 4.6.3.2. Second order balance shafts

We try different configurations using second order balance shafts to counteract the second order forces that are dominant in this case. Since for this arrangement, there is a first order moment and no first order forces, we need only one double first order balance shaft, the case with one or two double first order balance shafts are equivalent. So we discuss only three different cases, one with an optimized crankshaft and two second order balance shafts (case 5), one with an optimized crankshaft, one first and one second order balance shaft (case 6, the case 8 being equivalent with two first order balance shafts) and finally one with an optimized

crankshaft, one first and two second order balance shafts (case 7, the case 9 being equivalent). The results are given in table 21 and figure 48.

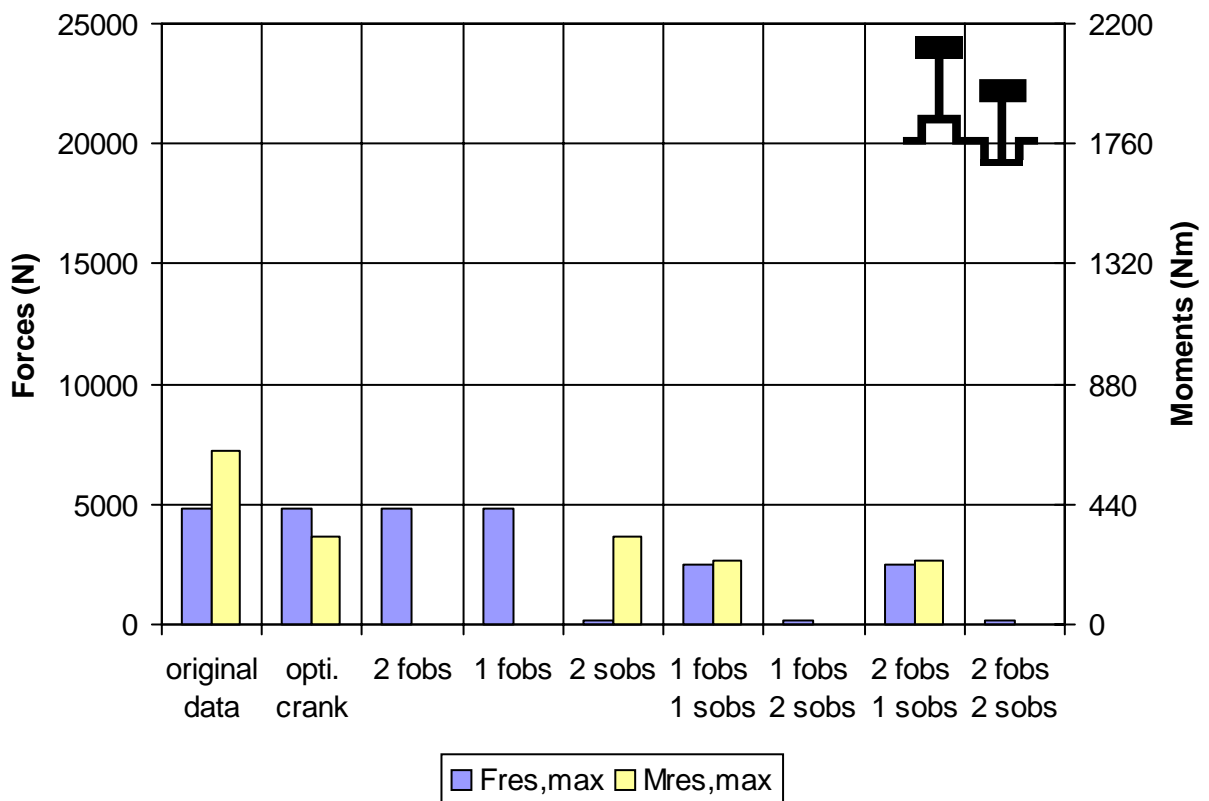
#### 4.6.4. Summary

Here are a few remarks concerning these results:

- The unbalance mass of one half of the first order double balance shaft (FOBS) is 0,02063 kg\*m.
- The unbalance mass of the second order balance shafts (SOBS) is 0,00336 kg\*m.
- The unbalance mass of the crankshaft is given in the table but it is the value for one half crankshaft (this value is null for the entire crankshaft).

Case	1	2	3	4	5	6	7	8	9
Name	Basic	opti. crank	2FOBS	1FOBS	opti. c. 2SOBS	1FOBS 1SOBS	1FOBS 2SOBS	2FOBS 1SOBS	2FOBS 2SOBS
Crank (kg*m)	0,02054	0,04116	0,02054	0,04116	0,04116	0,04116	0,04116	0,02054	0,02054
$F_{x,max}$ (N)	4845	4845	4845	4845	125	2485	125	2485	125
$F_{y,max}$ (N)	0	0	0	0	0	2360	0	2360	0
$F_{res,max}$ (N)	4845	4845	4845	4845	125	2485	125	2485	125
$\Delta F_{res}$ (N)	4804	4804	4804	4804	120	250	120	250	120
$M_{x,max}$ (Nm)	0	318	0	0	318	0	0	0	0
$M_{y,max}$ (Nm)	637	319	0	0	319	0	0	0	0
$M_{z,max}$ (Nm)	0	0	0	0	0	236	0	236	0
$M_{res,max}$ (Nm)	637	319	0	0	319	236	0	236	0
$\Delta M_{res}$ (Nm)	637	0	0	0	0	236	0	236	0
Complexity	--	-	++	+	++	++	+++	+++	++++

**Table 21: Maximum values of forces and moments for different balancing systems of the shorter stroke out-of-phase in-line twin-cylinder engine rotating at 4000 rpm**



**Figure 48: Maximum values of resulting forces and moments for different balancing systems of the shorter stroke out-of-phase in-line twin-cylinder engine rotating at 4000 rpm**

## 4.7. Longer stroke twin-cylinder in-line engine, out-of-phase arrangement

The forces generated by the longer stroke engine are a little higher than the ones of the shorter stroke engine but they have the same aspect for the same configuration of engine and balancing system. Thus, we do not discuss all the results but we only give them in a table (table 22) and graphic (figure 49).

Here are a few remarks concerning the results presented in table 22 and figure 49:

- The unbalance mass of one half of the first order double balance shaft (FOBS) is 0,023515 kg\*m.
- The unbalance mass of the second order balance shafts (SOBS) is 0,00401 kg\*m.
- The unbalance mass of the crankshaft is given in the table but it is the value for one half crankshaft (this value is null for the entire crankshaft).

Case	1	2	3	4	5	6	7	8	9
Name	Basic	opti. crank	2FOBS	1FOBS	opti. c. 2SOBS	1FOBS 1SOBS	1FOBS 2SOBS	2FOBS 1SOBS	2FOBS 2SOBS
Crank (kg*m)	0,02001	0,04353	0,02001	0,04353	0,04353	0,04353	0,04353	0,02001	0,02001
$F_{x,max}$ (N)	5794	5794	5794	5794	163	2978	163	2978	163
$F_{y,max}$ (N)	0	0	0	0	0	2816	0	2816	0
$F_{res,max}$ (N)	5794	5794	5794	5794	163	2978	163	2978	163
$\Delta F_{res}$ (N)	5760	5760	5760	5760	157	326	157	326	157
$M_{x,max}$ (Nm)	0	363	0	0	363	0	0	0	0
$M_{y,max}$ (Nm)	726	363	0	0	363	0	0	0	0
$M_{z,max}$ (Nm)	0	0	0	0	0	282	0	282	0
$M_{res,max}$ (Nm)	726	363	0	0	363	282	0	282	0
$\Delta M_{res}$ (Nm)	726	0	0	0	0	282	0	282	0
Complexity	--	-	++	+	++	++	+++	+++	++++

Table 22: Maximum values of forces and moments for different balancing systems of the longer stroke out-of-phase in-line twin-cylinder engine rotating at 4000 rpm

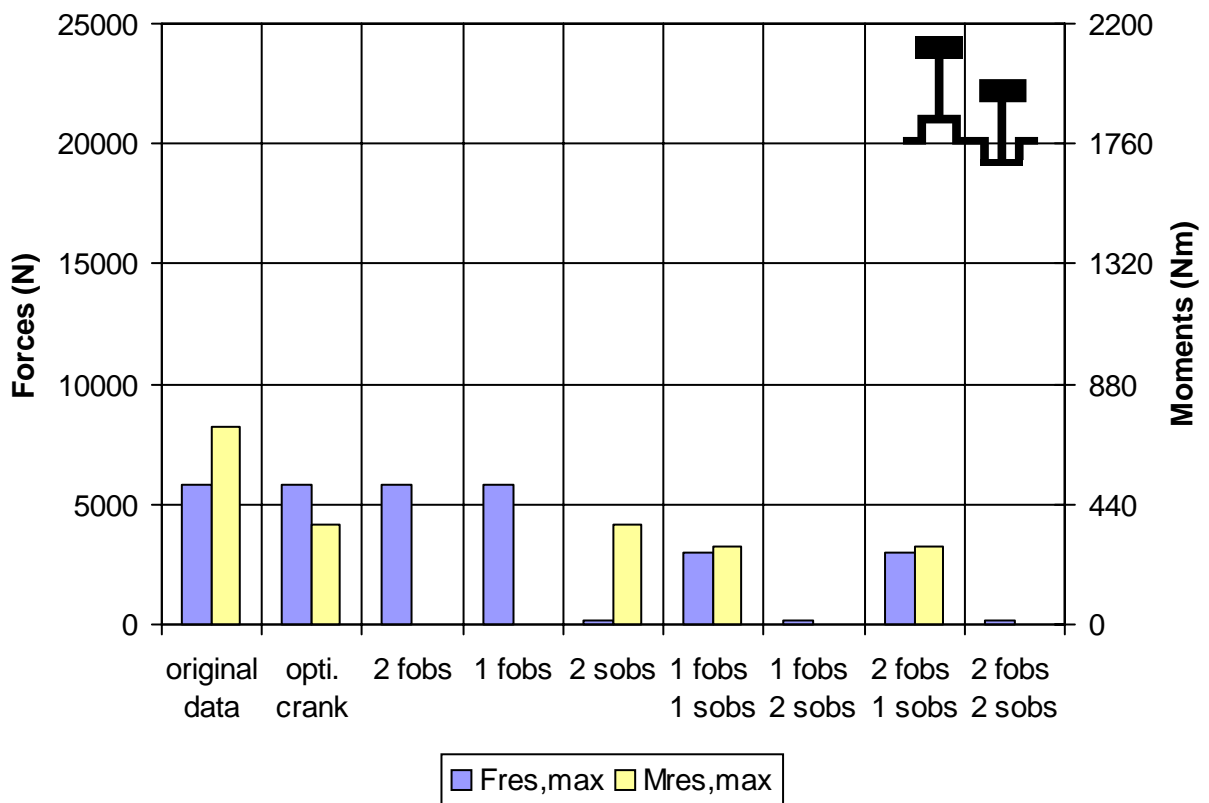


Figure 49: Maximum values of resulting forces and moments for different balancing systems of the longer stroke out-of-phase in-line twin-cylinder engine rotating at 4000 rpm

## 4.8. Shorter stroke twin-cylinder boxer engine, out-of-phase arrangement

We focus now on the second type of engine, the boxer engine, with the out-of-phase configuration of the crankshaft. So we expect, as we have seen in the modeling section, that the high order (strictly higher than the first order) forces vanish and that there are free moments due to the misalignment of the forces.

We proceed, as for the in-line engine, by studying the behavior with the reference data, then we optimize the crankshaft and we finish by calculating different configurations of crank and balance shafts.

### 4.8.1. Reference data (case 1)

The second and fourth order forces are equal to zero and the total X-force is equal to the oscillating first order force. We notice also that the disadvantage of this configuration is that the opposite motion of the piston produces second and fourth order moments around the Y-axis (see figure 50).

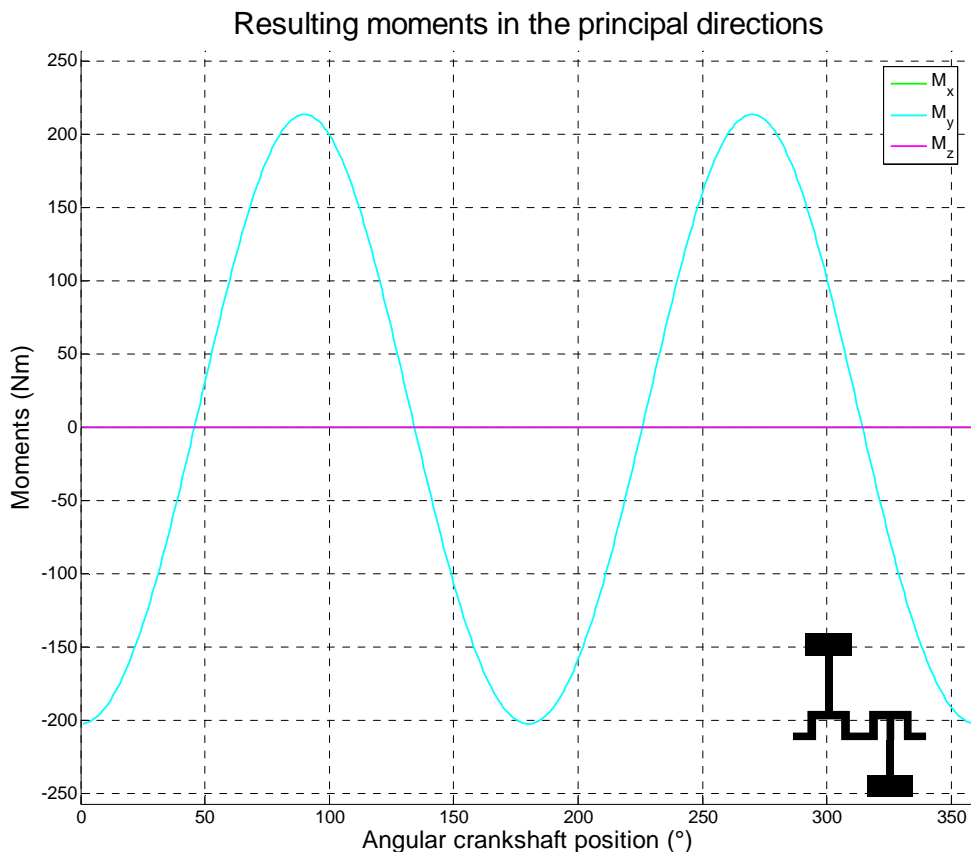


Figure 50: Moments for shorter stroke out-of-phase twin-cylinder boxer engine

### 4.8.2. Optimized crank and balance shafts

There is two problems with this configuration, the first order force and the second order moment; the first order force can be reduced by optimizing the crankshaft (case 2 and 5),



using one (case 4, 6 and 7) or two (case 3, 8 and 9) first order balance shafts. The second order moment can be reduced by using two second order double balance shafts.

These second order double balance shafts are the equivalent of the double balance shaft used for the out-of-phase in-line engine. But in this configuration, we can not counteract the yaw moment by modifying the counterweight of the crankshaft so we use two counterrotative balance shafts.

Another solution to reduce the pitching moment is to reduce the distance between the axes of the cylinders. This solution is possible for the boxer engine because the cylinders are not on the same row. We can go further and put the two cylinders on the same axis by using one special connecting rod (figure 9) that completely suppresses the pitching moment without using expensive second order balance shafts. Nevertheless, at this point of the study, we decide to keep the same distance between the pistons that the in-line engine in order to compare easily the two types of engine. We will focus on the impact of this distance in the sensitivity analysis section of this report.

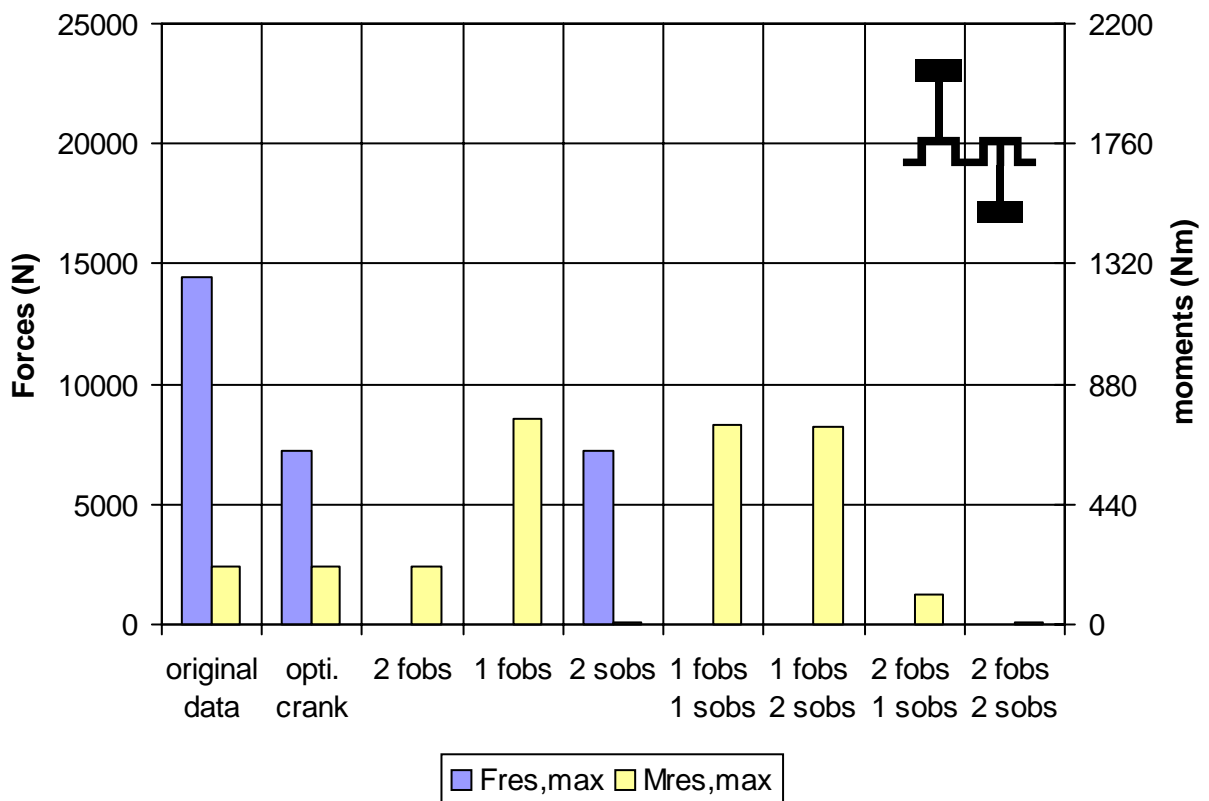
### 4.8.3. Summary

Here are a few remarks concerning the results presented in table 23 and figure 51:

- The unbalance mass of the first order balance shaft (FOBS) is 0,04125 kg\*m.
- The unbalance mass of one half of the second order double balance shafts (SOBS) is 0,00168 kg\*m.
- The unbalance mass of the crankshaft is given in the table but it is the value for one half crankshaft (this value has to be doubled for the entire crankshaft).

Case	1	2	3	4	5	6	7	8	9
Name	Basic	opti. crank	2FOBS	1FOBS	opti. c. 2SOBS	1FOBS 1SOBS	1FOBS 2SOBS	2FOBS 1SOBS	2FOBS 2SOBS
Crank (kg*m)	0,02054	0,04116	0,02054	0,04116	0,04116	0,04116	0,04116	0,02054	0,02054
$F_{x,max}$ (N)	14476	7239	0	0	7239	0	0	0	0
$F_{y,max}$ (N)	0	7237	0	0	7237	0	0	0	0
$F_{res,max}$ (N)	14476	7239	0	0	7239	0	0	0	0
$\Delta F_{res}$ (N)	14476	2	0	0	0	0	0	0	0
$M_{x,max}$ (Nm)	0	0	0	0	0	104	0	104	0
$M_{y,max}$ (Nm)	213	213	213	213	5	109	5	109	5
$M_{z,max}$ (Nm)	0	0	0	724	0	724	724	0	0
$M_{res,max}$ (Nm)	213	213	213	752	5	730	724	109	5
$\Delta M_{res}$ (Nm)	211	211	211	538	5	621	718	11	5
Complexity	--	-	++	+	++	++	+++	+++	++++

**Table 23: Maximum values of forces and moments for different balancing systems of the shorter stroke out-of-phase twin-cylinder boxer engine rotating at 4000 rpm**



**Figure 51: Maximum values of resulting forces and moments for different balancing systems of the shorter stroke out-of-phase twin-cylinder boxer engine rotating at 4000 rpm**

## 4.9. Longer stroke twin-cylinder boxer engine, out-of-phase arrangement

Here are a few remarks concerning the results presented in table 24 and figure 52:

- The unbalance mass of the first order balance shaft (FOBS) is 0,04703 kg\*m.
- The unbalance mass of one half of the second order double balance shafts (SOBS) is 0,00201 kg\*m.
- The unbalance mass of the crankshaft is given in the table but it is the value for one half crankshaft (this value has to be doubled for the entire crankshaft).

Case	1	2	3	4	5	6	7	8	9
Name	Basic	opti. crank	2FOBS	1FOBS	opti. c. 2SOBS	1FOBS 1SOBS	1FOBS 2SOBS	2FOBS 1SOBS	2FOBS 2SOBS
Crank (kg*m)	0,02001	0,04353	0,02001	0,04353	0,04353	0,04353	0,04353	0,02001	0,02001
$F_{x,max}$ (N)	16505	8253	1	1	8253	1	1	1	1
$F_{y,max}$ (N)	0	8252	0	0	8252	0	0	0	0
$F_{res,max}$ (N)	16505	8253	1	1	8253	1	1	1	1
$\Delta F_{res}$ (N)	16505	0	1	1	1	1	1	1	1
$M_{x,max}$ (Nm)	0	0	0	0	0	124	0	124	0
$M_{y,max}$ (Nm)	255	255	255	255	7	131	7	131	7
$M_{z,max}$ (Nm)	0	0	0	825	0	825	825	0	0
$M_{res,max}$ (Nm)	255	255	255	860	7	833	825	131	7
$\Delta M_{res}$ (Nm)	253	253	253	605	7	702	818	14	7
Complexity	--	-	++	+	++	++	+++	+++	++++

Table 24: Maximum values of forces and moments for different balancing systems of the longer stroke out-of-phase twin-cylinder boxer engine rotating at 4000 rpm

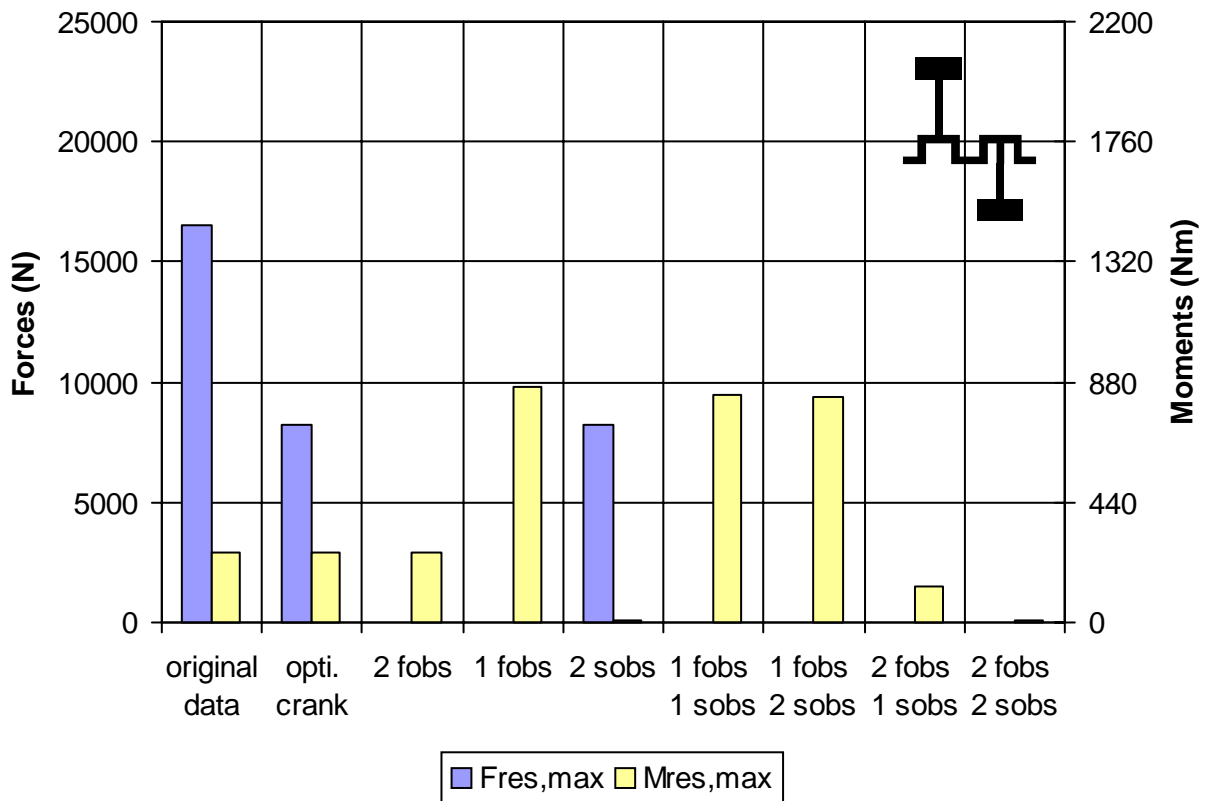


Figure 52: Maximum values of resulting forces for different balancing systems of the longer stroke out-of-phase twin-cylinder boxer engine

## 4.10. Shorter stroke twin-cylinder boxer engine, in-phase arrangement

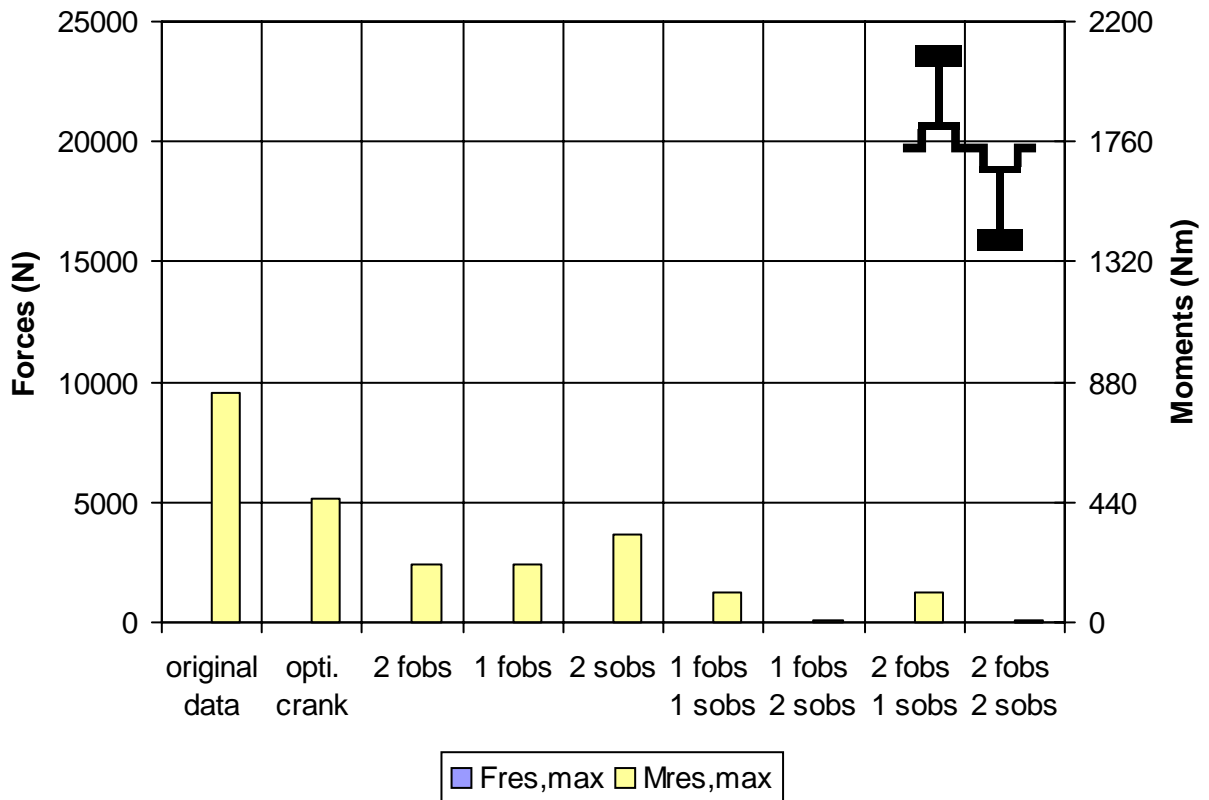
We see in table 25, that the characteristics of the in-phase boxer engine is that **the forces are null** (see also figure 53) and that there are pitching moments of first, second and fourth orders. To reduce these moments, we use different methods, optimizing the crankshaft, using first and second orders double balance shafts. We could also reduce the distance between the axes of the two cylinders; we will study this solution in a next section.

Here are a few remarks concerning the results presented in table 25 and figure 53:

- The unbalance mass of one half of the first order double balance shaft (FOBS) is 0,020623 kg\*m.
- The unbalance mass of one half of the second order double balance shafts (SOBS) is 0,00168 kg\*m.
- The unbalance mass of the crankshaft is given in the table but it is the value for one half crankshaft (this value is equal to zero for the entire crankshaft).

Case	1	2	3	4	5	6	7	8	9
Name	Basic	opti. crank	2FOBS	1FOBS	opti. c. 2SOBS	1FOBS 1SOBS	1FOBS 2SOBS	2FOBS 1SOBS	2FOBS 2SOBS
Crank (kg*m)	0,02054	0,04561	0,02054	0,04116	0,04116	0,04116	0,04116	0,02054	0,02054
$F_{x,max}$ (N)	0	0	0	0	0	0	0	0	0
$F_{y,max}$ (N)	0	0	0	0	0	0	0	0	0
$F_{res,max}$ (N)	0	0	0	0	0	0	0	0	0
$\Delta F_{res}$ (N)	0	0	0	0	0	0	0	0	0
$M_{x,max}$ (Nm)	0	387	0	0	318	104	0	104	0
$M_{y,max}$ (Nm)	839	452	213	213	324	109	5	109	5
$M_{z,max}$ (Nm)	0	0	0	0	0	0	0	0	0
$M_{res,max}$ (Nm)	839	452	213	213	324	109	5	109	5
$\Delta M_{res}$ (Nm)	836	404	211	211	11	11	5	11	5
Complexity	--	-	++	+	++	++	+++	+++	++++

**Table 25: Maximum values of forces and moments for different balancing systems of the shorter stroke in-phase twin-cylinder boxer engine rotating at 4000 rpm**



**Figure 53: Maximum values of resulting forces and moments for different balancing systems of the shorter stroke in-phase twin-cylinder boxer engine rotating at 4000 rpm**

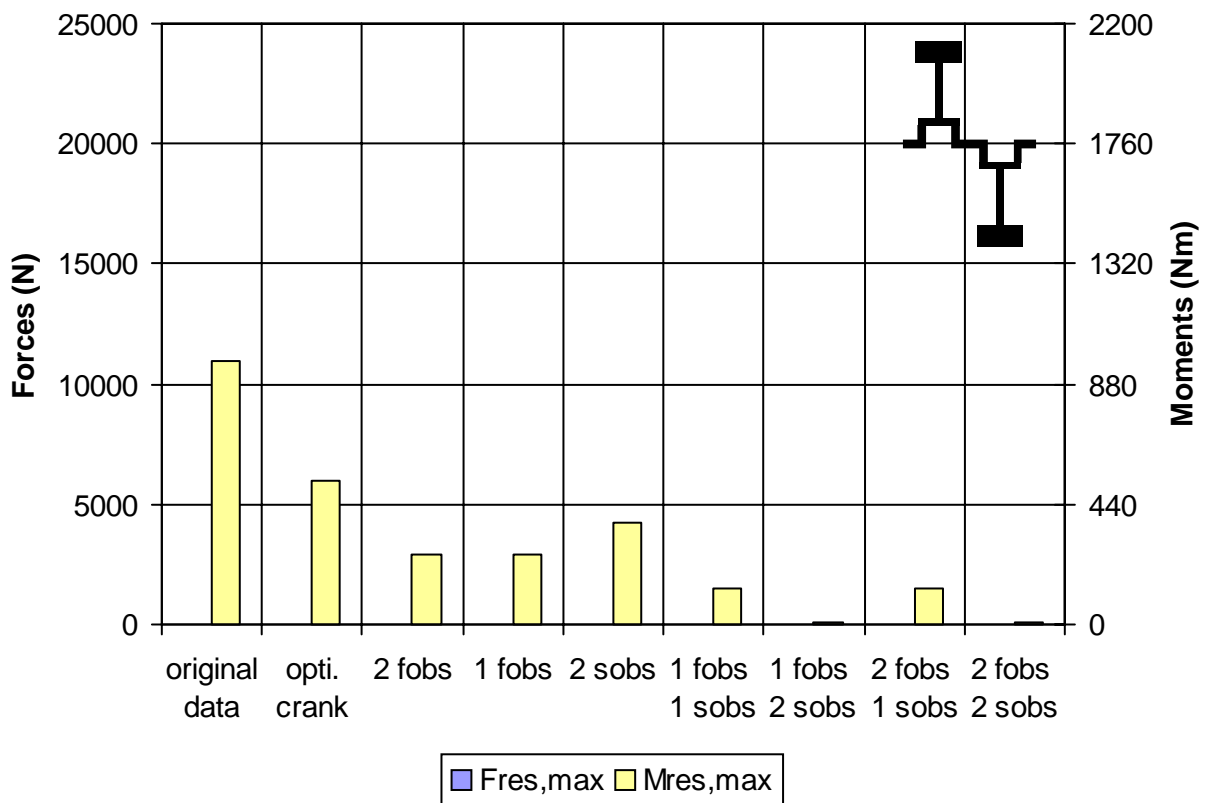
#### 4.11. Longer stroke twin-cylinder boxer engine, in-phase arrangement

Here are a few remarks concerning the results presented in table 26 and figure 54:

- The unbalance mass of one half of the first order double balance shaft (FOBS) is 0,023517 kg\*m.
- The unbalance mass of one half of the second order double balance shafts (SOBS) is 0,00201 kg\*m.
- The unbalance mass of the crankshaft is given in the table but it is the value for one half crankshaft (this value is equal to zero for the entire crankshaft).

Case	1	2	3	4	5	6	7	8	9
Name	Basic	opti. crank	2FOBS	1FOBS	opti. c. 2SOBS	1FOBS 1SOBS	1FOBS 2SOBS	2FOBS 1SOBS	2FOBS 2SOBS
Crank (kg*m)	0,02001	0,04875	0,02001	0,04353	0,04353	0,04353	0,04353	0,02001	0,02001
$F_{x,max}$ (N)	0	0	0	0	0	0	0	0	0
$F_{y,max}$ (N)	0	0	0	0	0	0	0	0	0
$F_{res,max}$ (N)	0	0	0	0	0	0	0	0	0
$\Delta F_{res}$ (N)	0	0	0	0	0	0	0	0	0
$M_{x,max}$ (Nm)	0	444	0	0	363	124	0	124	0
$M_{y,max}$ (Nm)	967	523	255	255	370	131	7	131	7
$M_{z,max}$ (Nm)	0	0	0	0	0	0	0	0	0
$M_{res,max}$ (Nm)	967	523	255	255	370	131	7	131	7
$\Delta M_{res}$ (Nm)	963	481	253	253	14	14	7	14	7
Complexity	--	-	++	+	++	++	+++	+++	++++

**Table 26: Maximum values of forces and moments for different balancing systems of the longer stroke in-phase twin-cylinder boxer engine rotating at 4000 rpm**



**Figure 54: Maximum values of resulting forces and moments for different balancing systems of the longer stroke in-phase twin-cylinder boxer engine rotating at 4000 rpm**



## 5. Effect of the gas pressure

The effect of the gas pressure inside the cylinder is now considered in the calculation of the forces in the engine. The pressure in the cylinder has been determined by experiments on an existing similar diesel engine by Breuer Technical Development. The gas pressure at **full throttle** is known for every position of the crankshaft angle between 0 and 720 degree and for different engine speeds (1000, 2000, 3000 and 4000 rpm).

### 5.1. Single-cylinder engine

Figure 55 shows the pressure inside the cylinder for the engine rotating at 2000 rpm and the throttle opened wide. When the piston is close to the top dead center (crank angle equal to 360°), the fuel is injected in the cylinder. The mix of fuel and air compressed by the piston ignites and the combustion begins. The combustion produces hot gases that increase the pressure in the cylinder (curve peak in figure 55) and force the piston to move to the bottom dead center, it is the power stroke.

The figure 56 shows the same curve for different engine speeds. We notice that at 1000 rpm (idle speed) the peak is smaller than at 2000 rpm (about 33% smaller). But after 2000 rpm, the pressure remains nearly constant and the maximum pressure, occurring a dozen of degrees after the top dead center, is more or less 180 bars at 2000, 3000 and 4000 rpm.

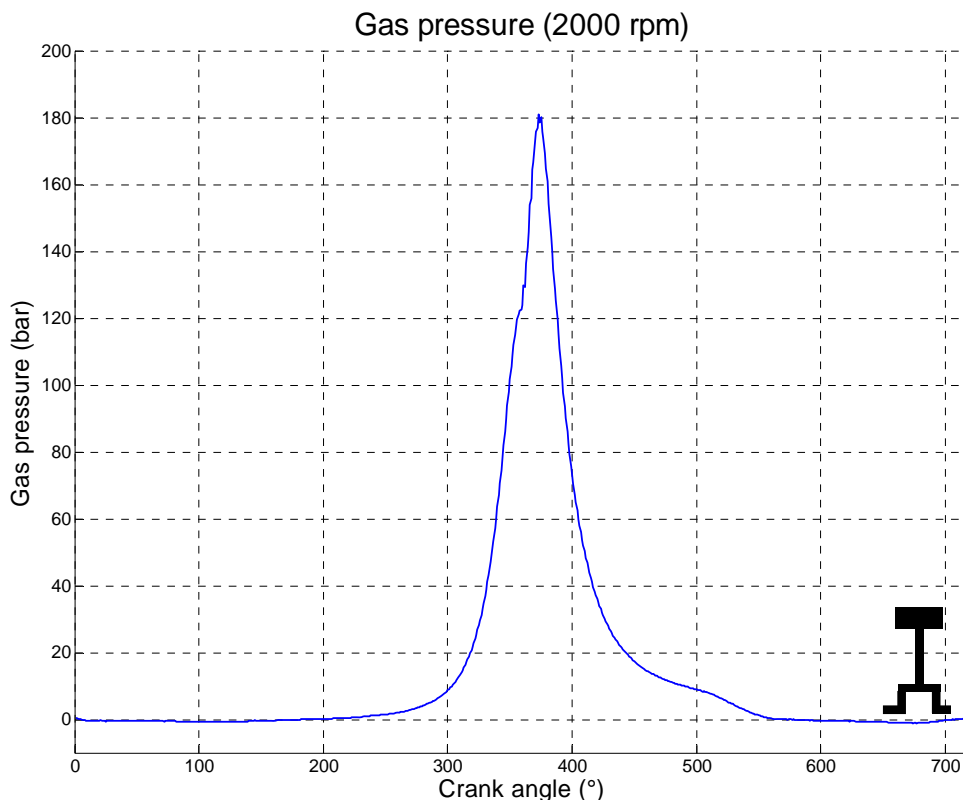
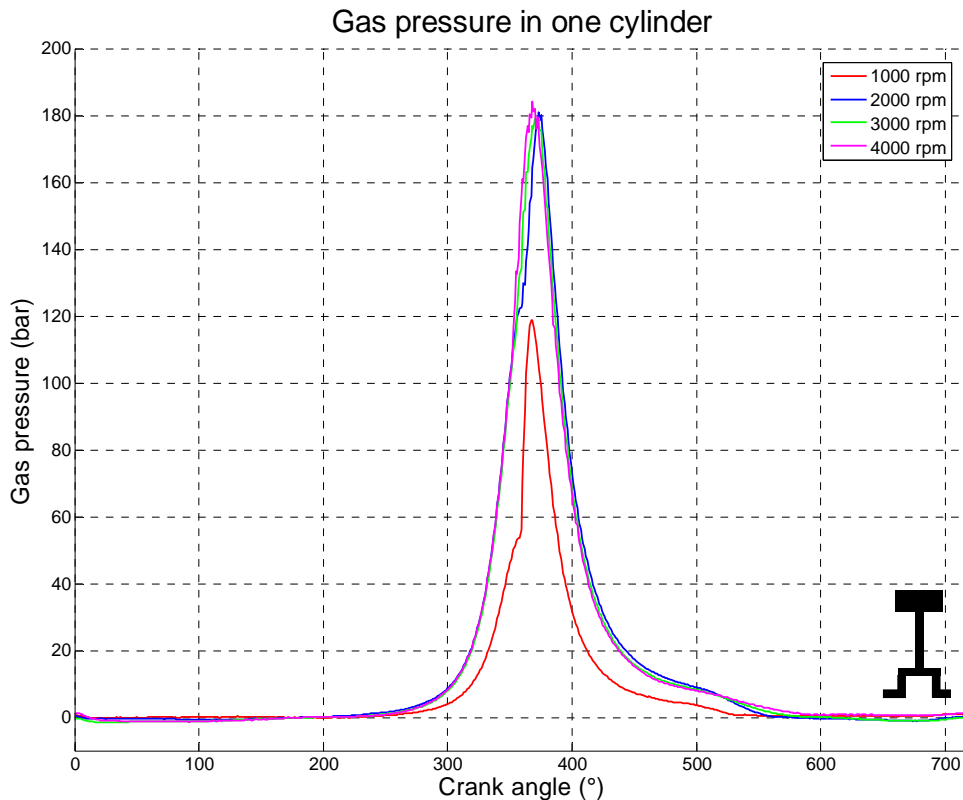


Figure 55: Gas pressure inside the cylinder for the single-cylinder engine rotating at 2000 rpm

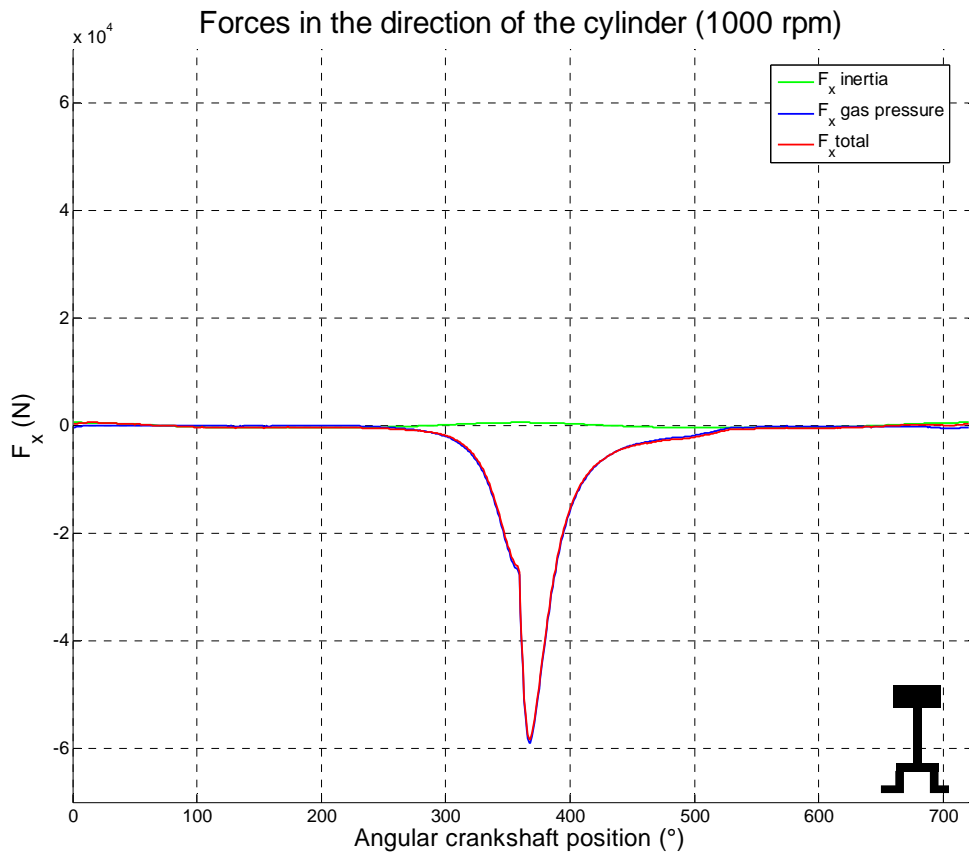


**Figure 56: Gas pressure in the single-cylinder engine for different speeds**

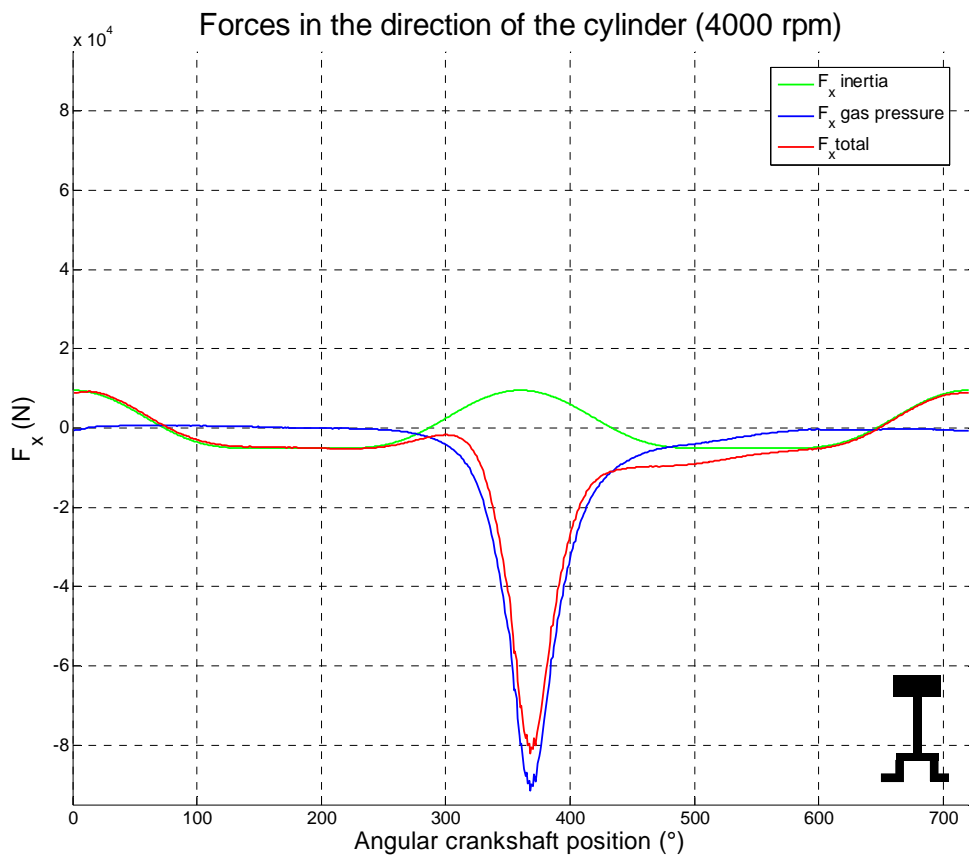
Figures 57 and 58 shows, for different speeds of the shorter stroke single-cylinder engine, the inertia force, the gas pressure force and the sum of these forces which is the **total force applied on the piston**. The force due to the gas pressure that is applied on the piston is not transmitted to the engine mounts because it is counteracted by the gas force that is applied on the cylinder head (see figure 16).

In figure 57, we notice that the peak in the gas force is negative; this comes from the choice of axes, this means that the gas force points toward the crankshaft. We also notice that when the engine rotates slowly (1000 rpm), the inertia forces are very small compared to the gas force (with throttle opened wide). So the total force applied on the piston is nearly equal to the gas force.

When the engine rotates faster (see figure 58), things are slightly different. Inertia forces grow with the square of the speed and begin to become important at 4000 rpm. Though the maximal value of the inertia forces is still small compared to the peak of gas force, its effect is not negligible and tends to reduce the peak of force on the piston. And when the piston is at the top dead center after the exhaust stroke (crankshaft angle =  $0^\circ$ ), the inertia forces are prevailing because there is no combustion. This affects the torque variation.



**Figure 57: Inertia force and gas pressure force in the shorter stroke single-cylinder engine (1000 rpm)**



**Figure 58: Inertia force and gas pressure force in the shorter stroke single-cylinder engine (4000 rpm)**

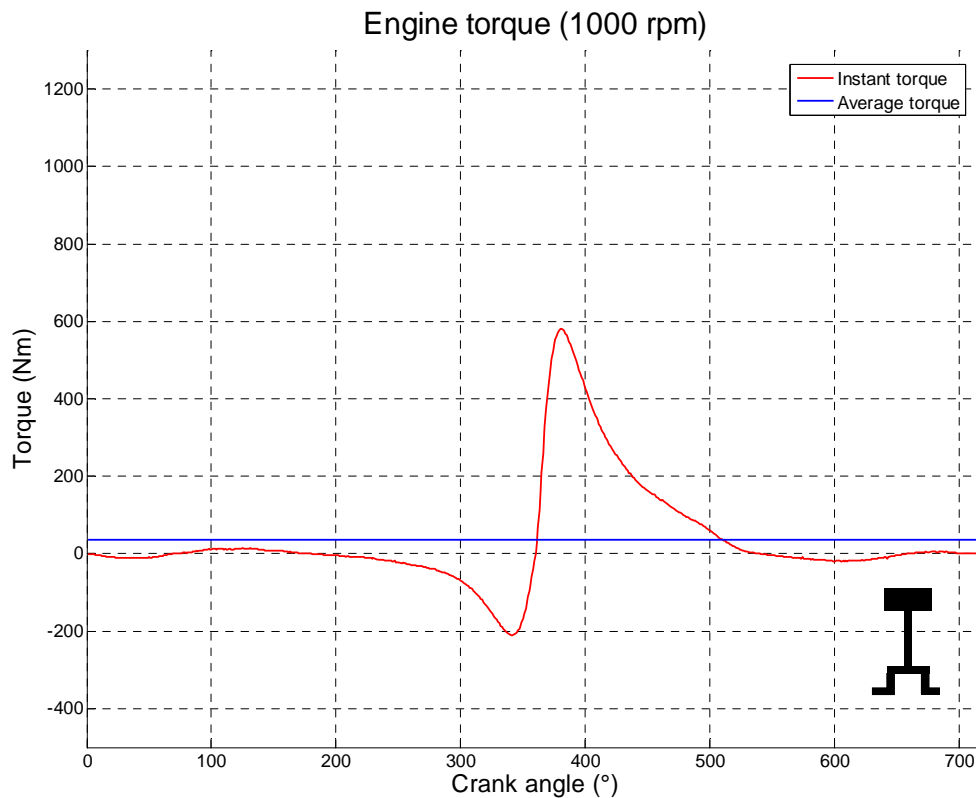
Figure 59 shows, for an engine speed of 1000 rpm, the variation of torque during two revolutions of the crankshaft. We notice that the torque oscillates around an average value, with one important peak that corresponds to the combustion of the fuel in the cylinder. This value depends from the engine speed and corresponds to the net indicated torque of the engine. To avoid important variations of speed over one revolution of the crankshaft, a flywheel is essential. To design it, the energy that it has to absorb and release at each revolution of the crankshaft has to be known because the energy stored in the flywheel ( $E$ ) is function of its moment of inertia ( $J$ ) and its angular speed ( $\omega$ ).

$$E = \frac{1}{2} \cdot J \cdot \omega^2 \quad (35)$$

This variation of energy is calculated by integration of the torque variations (absolute value of the difference between the instant and average torque). The table 27 shows the average torque and the variation of energy (received and given back by the flywheel during two revolutions of the crankshaft) with respect to the engine speed.

Engine speed (rpm)	1000	2000	3000	4000
Average Torque (Nm)	35,5	80	72,9	64,1
Variation of energy (J)	1106,1	2405,1	2342,9	2590,4

**Table 27: Average torque and variation of energy for the shorter stroke single-cylinder engine**



**Figure 59: Variation of torque in a shorter stroke single-cylinder engine rotating at 1000 rpm**

On the basis of the calculated average torque, an estimation of the power and torque curves can be drawn (figure 60). Knowing the torque in four operation points, the power can be deduced for this operation point (the power is the product of torque and angular speed). Then, a third degree polynomial extrapolation of the power curve is made (blue line). And the torque curve (red line) is calculated from the power curve (it is the reason why there are small differences between the torque curve and the calculated torque points, but a direct polynomial extrapolation of the torque curve does not give correct results).

From these curves, a maximum power of 26,9 kW (36,5 hp) at 3800 rpm can be expected from this engine. This is the *net indicated power* (power delivered to the piston over the entire four-stroke cycle), this power is calculated directly at the exit of the cylinder. It does not take into account the loss in the different engine organs (oil and water pumps, camshafts...) which lead to a smaller **brake power** (usable power delivered by the engine to the load [HEYWOOD 1988, pp. 46]).

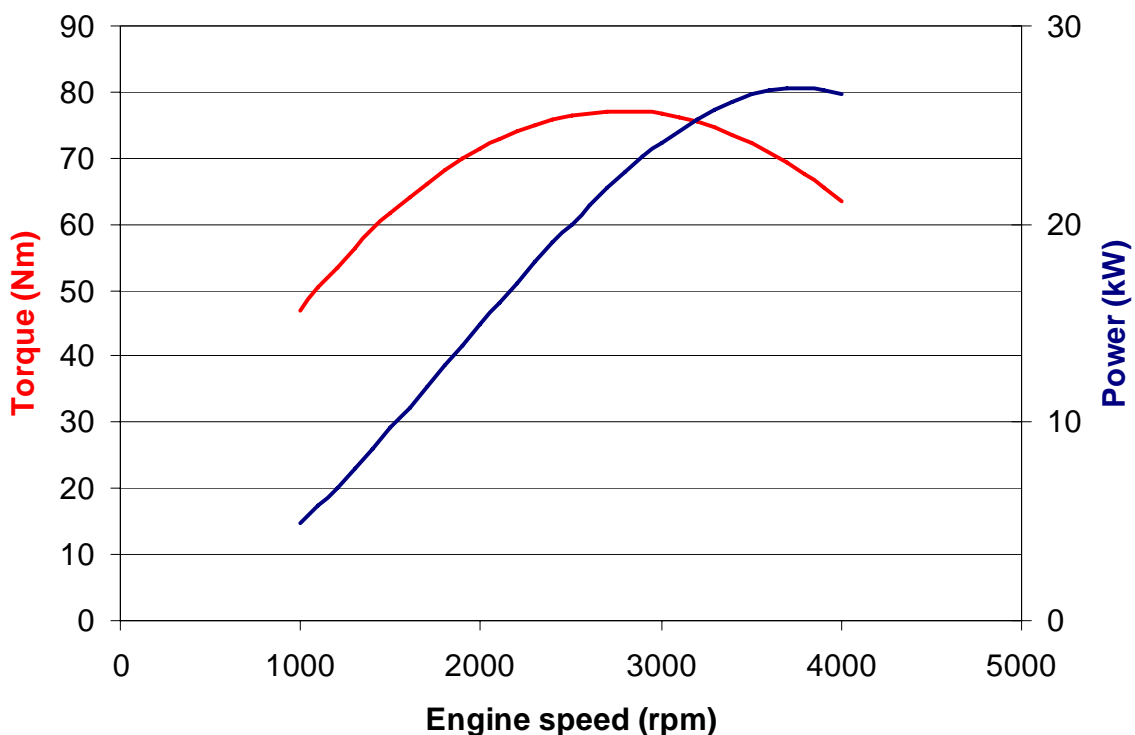


Figure 60: Extrapolation of the power and torque for the shorter stroke single-cylinder engine

## 5.2. In-line twin-cylinder in-phase engine

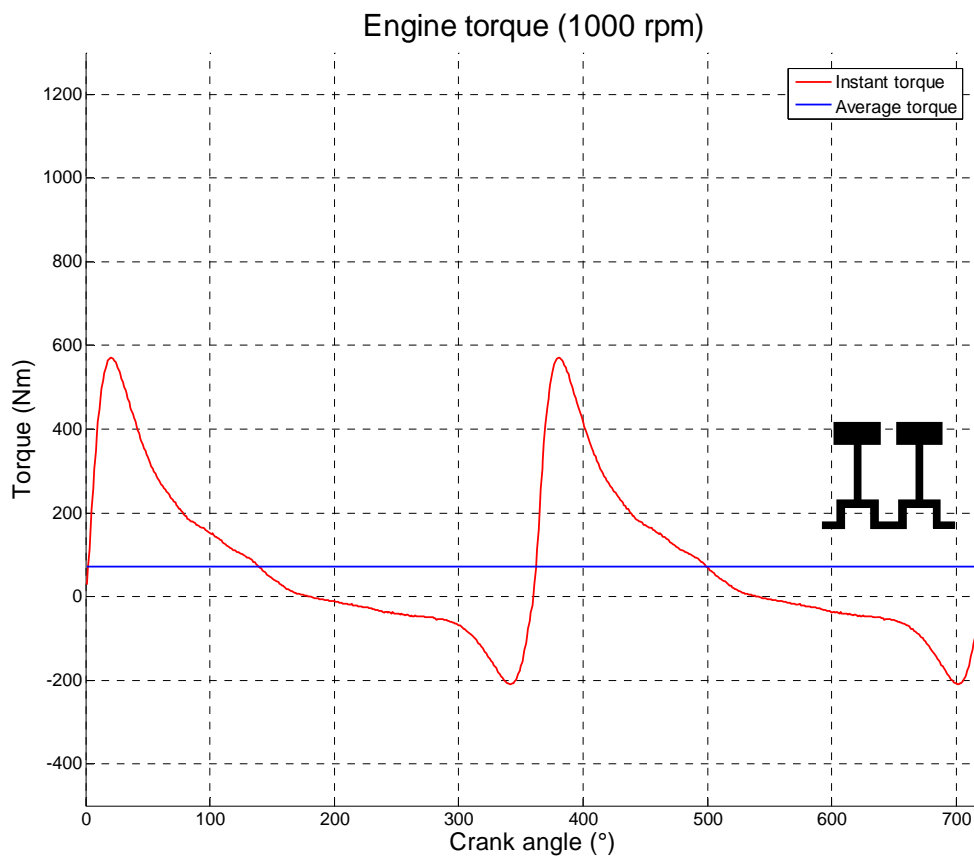
### 5.2.1. Shorter stroke

Figures 61 to 64 show, for different engine speeds, the variation of torque during two revolutions of the crankshaft of the in-phase in-line twin-cylinder engine. We notice that the instant torque curve has two major peaks (with a phase-shift of 360 degrees) corresponding to the combustion heat release in each of the two cylinders. The table 28 shows the average torque and the variation of energy (received and given back by the flywheel during **one revolution** of the crankshaft since the period of the instant torque variation is 360 degrees) with respect to the engine speed. We notice that although the twin-cylinder in phase in-line engine is twice more powerful than the single-cylinder engine, the variation of energy at the

flywheel is smaller. It is due to the combustion in the second cylinder that levels the variation torque. This is a disadvantage of the small engine: smaller is the number of cylinders for a given power, bigger will be the flywheel to smooth the speed variations of the crankshaft.

Engine speed (rpm)	1000	2000	3000	4000
Average Torque (Nm)	71,1	160	145,8	128,1
Variation of energy (J)	935,8	1968,3	1874,9	1982

**Table 28: Average torque and variation of energy for the shorter stroke in-phase in-line twin-cylinder engine**



**Figure 61: Variation of torque in a shorter stroke in-phase in-line twin-cylinder engine (1000 rpm)**

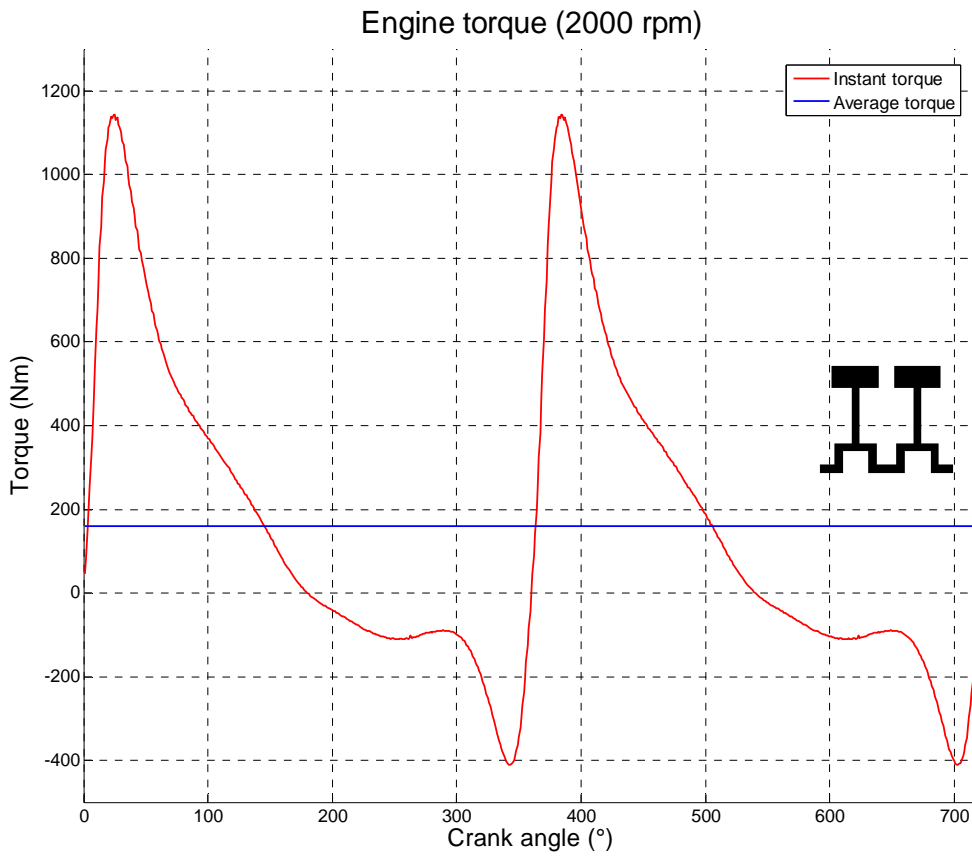


Figure 62: Variation of torque in a shorter stroke in-phase in-line twin-cylinder engine (2000 rpm)

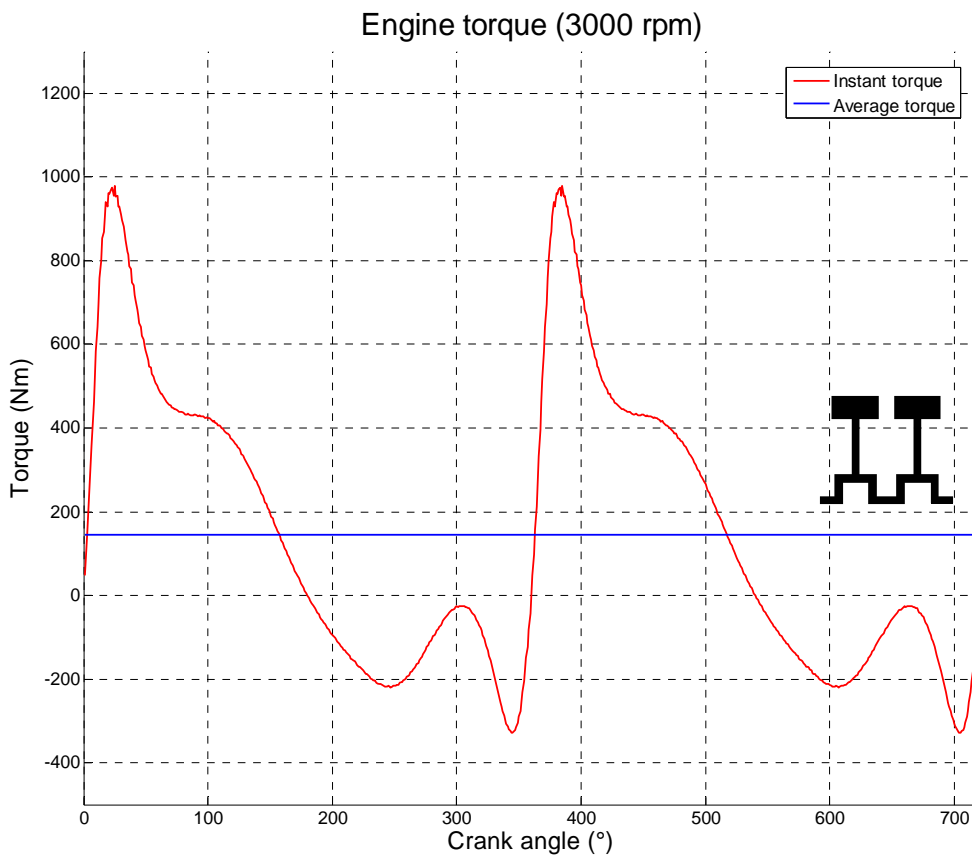
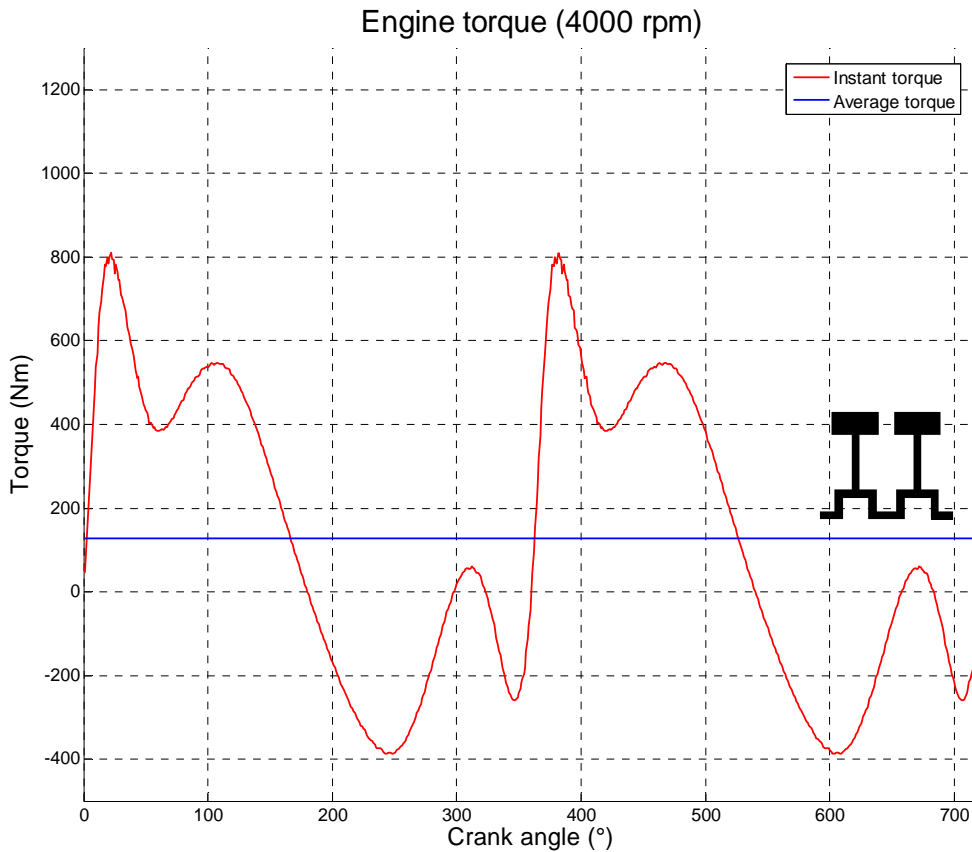
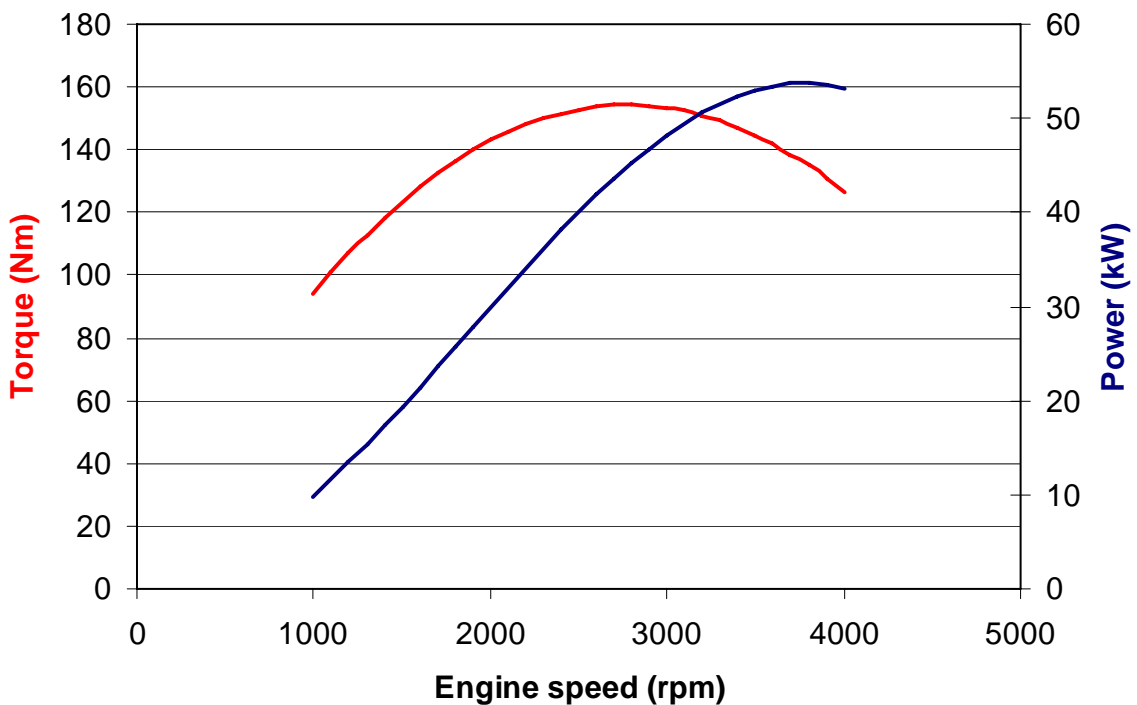


Figure 63: Variation of torque in a shorter stroke in-phase in-line twin-cylinder engine (3000 rpm)



**Figure 64: Variation of torque in a shorter stroke in-phase in-line twin-cylinder engine (4000 rpm)**

With the values of average torque that have been calculated, an estimation of the net indicated power and torque curves can be drawn (figure 65). From these curves, a net indicated maximum power of 53,7 kW (73 hp) at 3800 rpm can be expected from this engine.

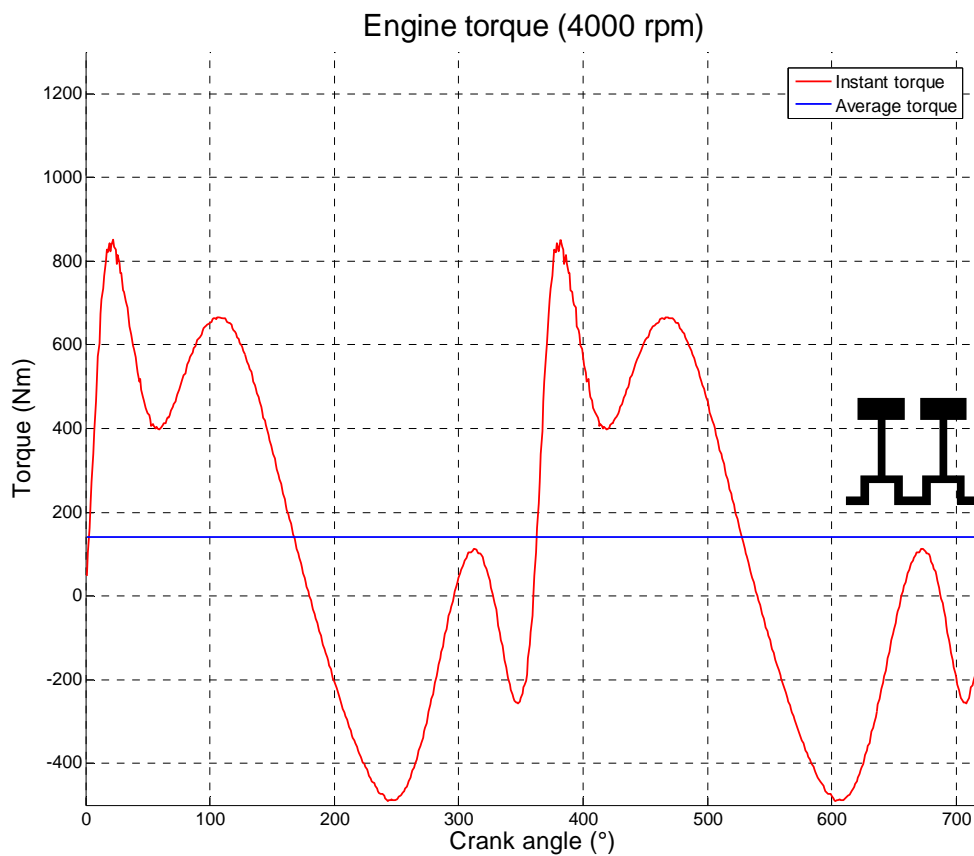


**Figure 65: Extrapolation of the power and torque for the shorter stroke twin-cylinder engine**



### 5.2.2. Longer stroke

The figure 66 shows the variation of torque during two revolutions of the crankshaft for the longer stroke engine rotating at 4000 rpm. We notice that the curves have the same aspect that the ones of figure 64 but the values are a little higher. So we do not reproduce all the graphics, we just give the new values of average torque and variation of energy (see table 29). Torque and power curves, extrapolated as in the previous section, can be seen in figure 67. We notice that the power and torque are a little higher (10,5 %) in the longer stroke engine. Another difference between the two engines is the variation of energy to be absorbed by the flywheel that is bigger in the longer stroke engine. From the figure 67, a maximum net indicated power of 59,4 kW (81 hp) at 3800 rpm can be expected.



**Figure 66: Variation of torque in a longer stroke in-phase in-line twin-cylinder engine (4000 rpm)**

Engine speed (rpm)	1000	2000	3000	4000
Average Torque (Nm)	78,6	176,9	161,2	141,6
Variation of energy (J)	1036,2	2185,1	2100,2	2245,6

**Table 29: Average torque and energy variation for the longer stroke in-phase in-line twin-cylinder engine**

Figure 68 shows the gas pressure force and the inertia force in the X-direction for the in-phase in-line engine in its basic configuration (basic crankshaft, no balance shaft) and for a rotation speed of 4000 rpm. As for the single-cylinder engine, the inertia forces are opposed to the gas force when the pistons are at the TDC. Nevertheless, as there are two cylinders, the inertia

forces are doubled. While the peak of force due to the combustion has the same value but occurs every 360 degrees instead of 720 degrees. It means that the peak of force due to the combustion is partially reduced by the inertia forces.

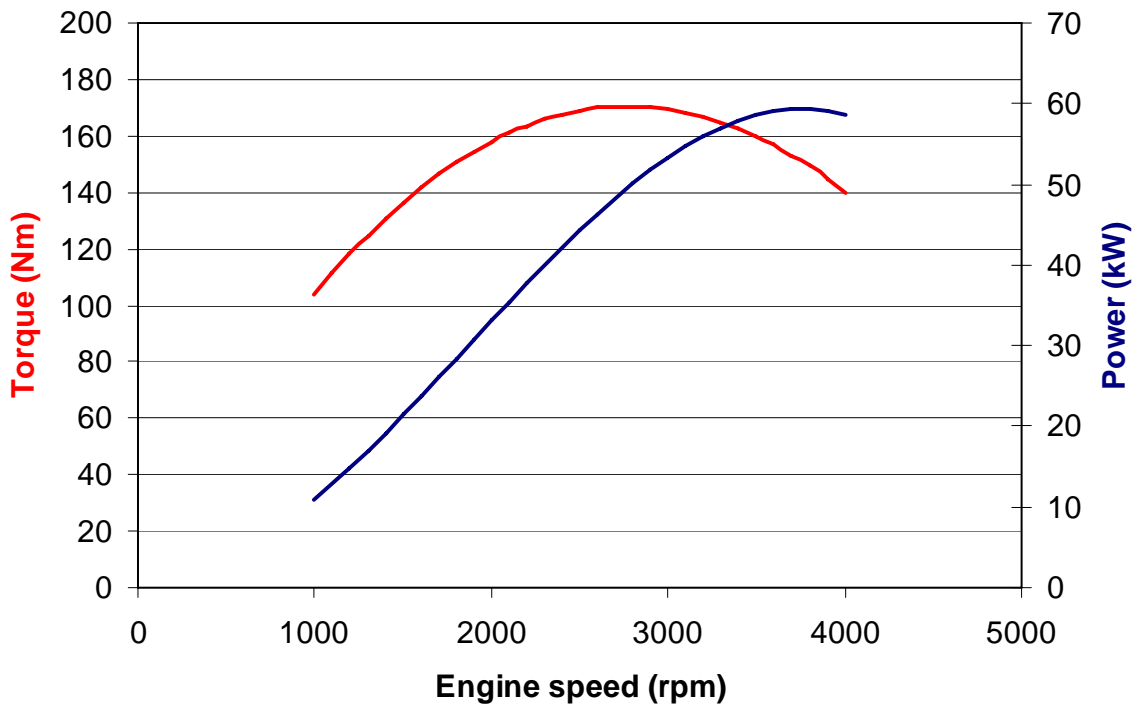


Figure 67: Extrapolation of the power and torque for the longer stroke twin-cylinder engine

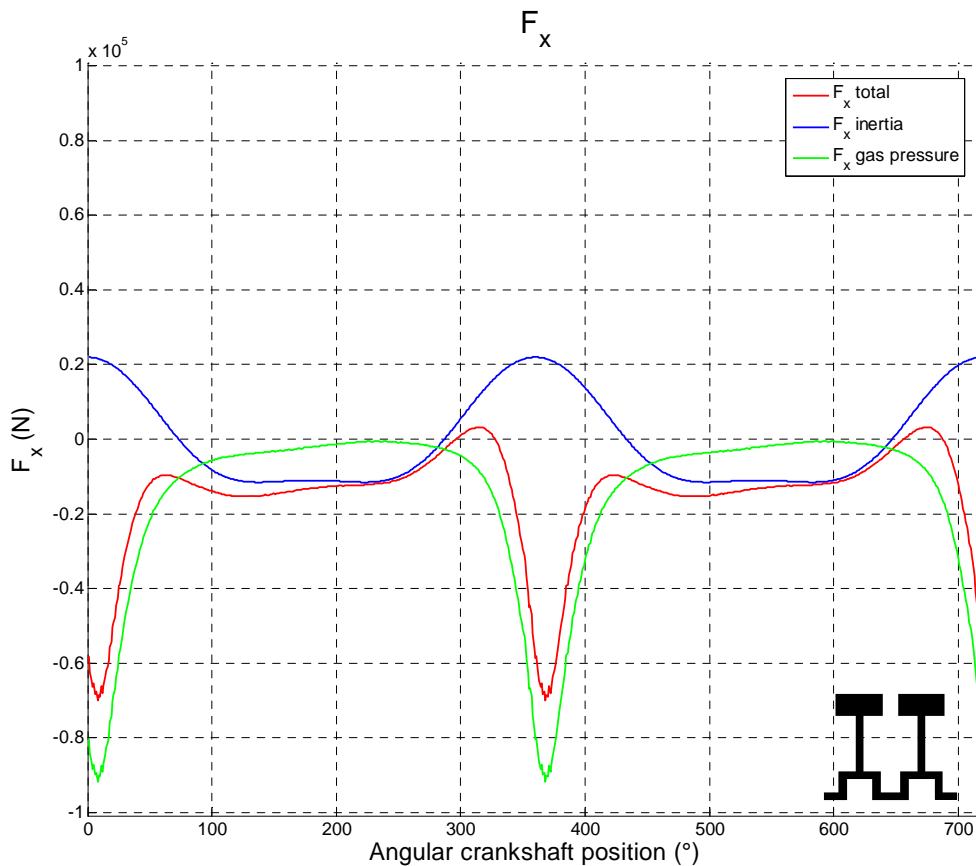


Figure 68: Inertia forces, gas pressure forces (full throttle) and total forces for the longer stroke in-phase in-line twin-cylinder engine (basic configuration) rotating at 4000 rpm

## 5.3. In-line twin-cylinder out-of-phase engine

### 5.3.1. Shorter stroke

The figure 69 and 70 show the variation of torque in the out-of-phase engine. We notice that there is a variable crank angle ( $180^\circ$  or  $540^\circ$ ) between the two torque peaks due to the phase shift of the pistons. So the periodicity of the torque variation is  $720^\circ$  whereas it is  $360^\circ$  for the in-phase engine. Therefore, we calculate the variation of energy for two rotations of the crankshaft instead of one. These variations of energy along with the average torques are given in table 30.

The most important thing to notice is that the average torque is equal to the one found for the shorter stroke in-phase engine. It means that *the torque and power do not depend on the configuration of the engine.*

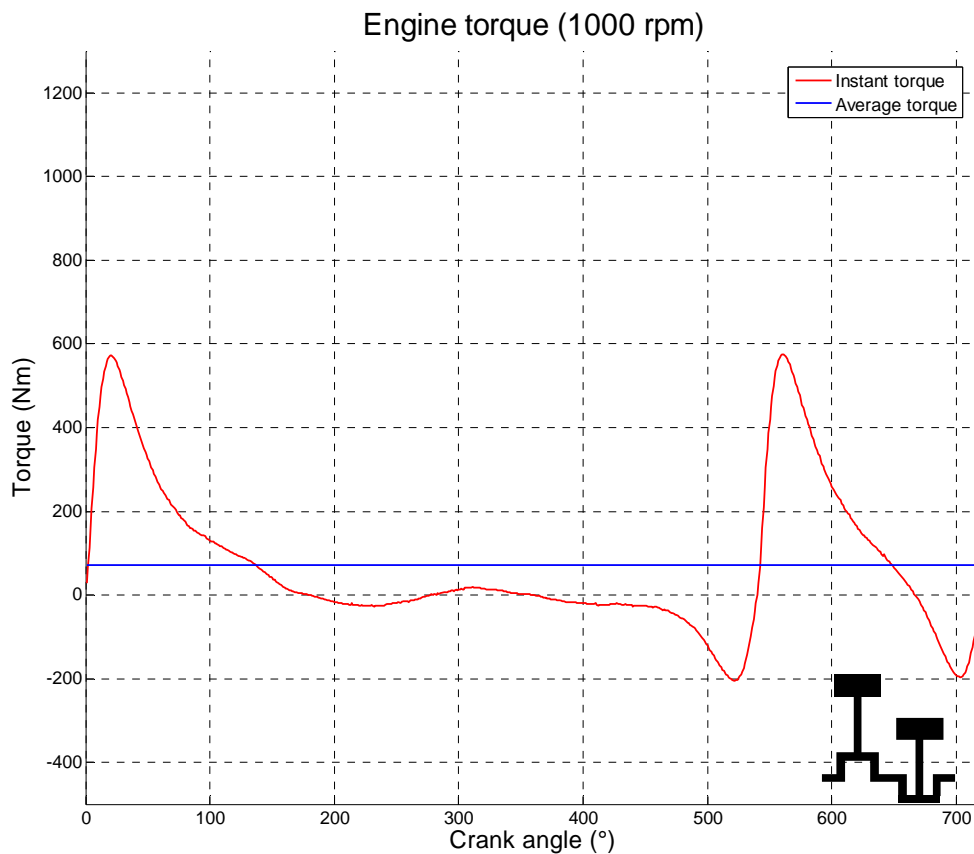
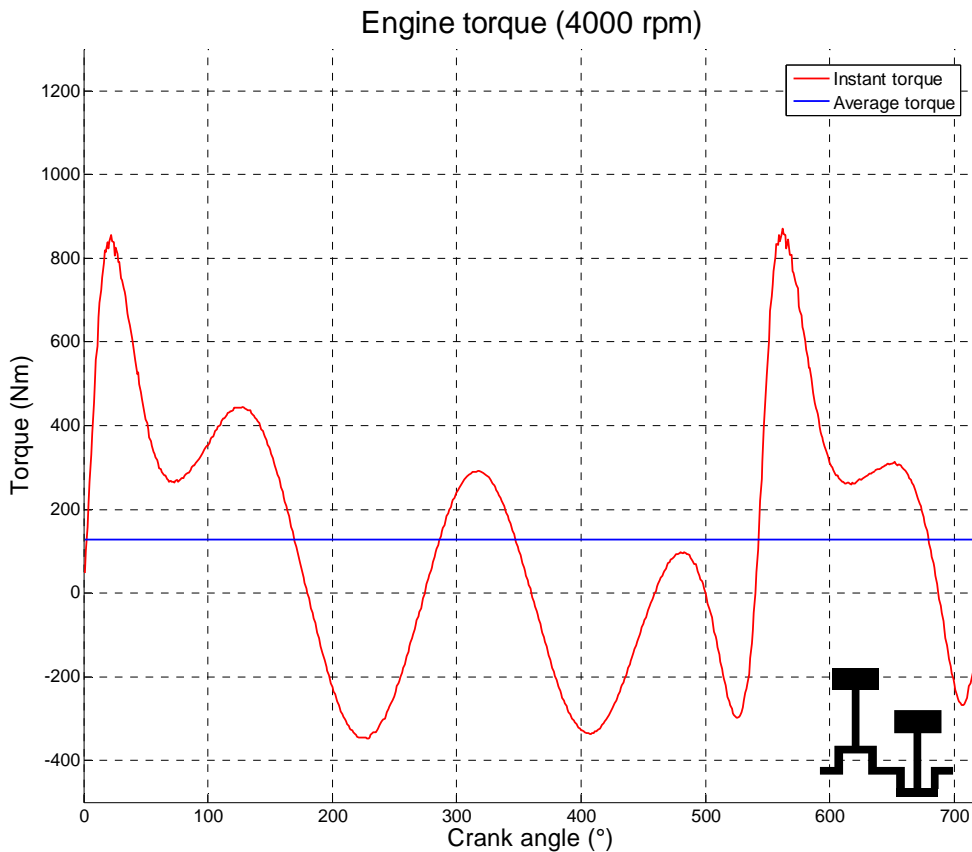


Figure 69: Variation of torque in a shorter stroke out-of-phase in-line twin-cylinder engine (1000 rpm)



**Figure 70: Variation of torque in a shorter stroke out-of-phase in-line twin-cylinder engine (4000 rpm)**

Engine speed (rpm)	1000	2000	3000	4000
Average Torque (Nm)	71,1	160	145,8	128,1
Variation of energy (J)	1726,7	3684,7	3349,4	3278,5

**Table 30: Average torque and energy variation for the shorter stroke out-of-phase in-line twin-cylinder engine**

The instant torque can be separated in two main contributions:

- The instant torque due to the gas pressure inside the cylinders (figure 71). This torque is the sum of the gas pressure torque inside each cylinder. Its average value depends from the pressure, the number of cylinders, the piston area and the crank arm. Since the crank arm is equal to the half of the stroke, it means that the average torque depends only from the pressure and the engine size (displacement).
- The instant torque due to the inertia forces (figure 72), its average value on one rotation of the crankshaft is zero.

No matter what is the configuration of the twin-cylinder engine, the average net indicated torque is the double of the torque produced by one cylinder. So the average torque of the engine depends only on the pressure inside the cylinders and the cylinders size (number of cylinder, stroke and piston area).

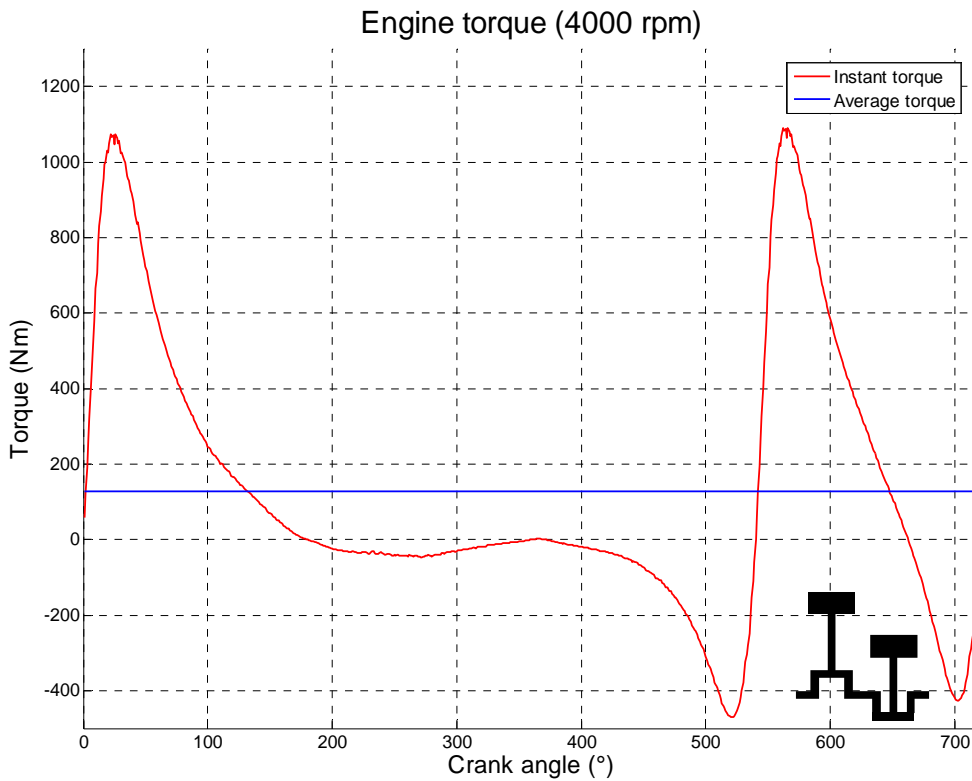


Figure 71: Part of the torque due to the gas pressure in an out-of-phase twin-cylinder engine

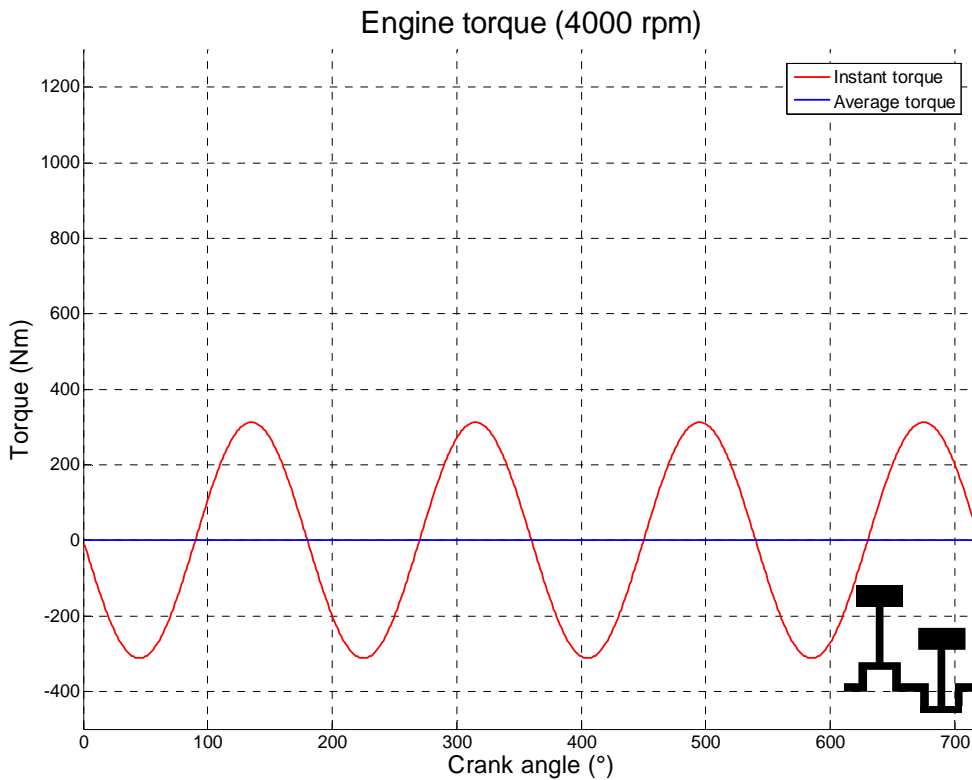


Figure 72: Part of the torque due to the inertia forces in an out-of-phase twin-cylinder engine

### 5.3.2. Longer stroke

As for the in-phase in-line engine, the longer stroke version of the out-of-phase in-line engine behaves similarly to the shorter stroke one. So we just look at the variations of energy and the

average torques (see table 31). As it is an out-of-phase engine, the energy variations are calculated on two rotations of the crankshaft.

Engine speed (rpm)	1000	2000	3000	4000
Average Torque (Nm)	78,6	176,9	161,2	141,6
Variation of energy (J)	1900,4	4047,2	3698,3	3670,8

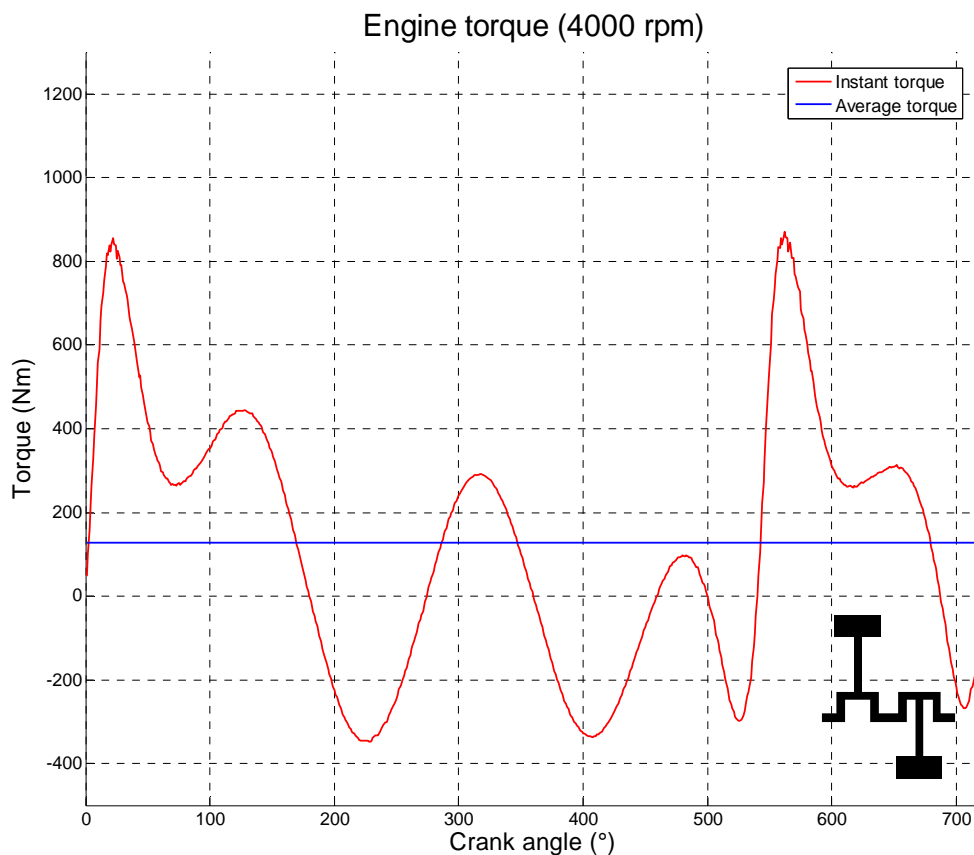
**Table 31: Average torque and variation of energy for the longer stroke out-of-phase in-line engine**

## 5.4. Boxer twin-cylinder out-of-phase engine

### 5.4.1. Shorter stroke

We notice that the figure 73, representing the variation of torque in an out-of-phase boxer engine rotating at 4000 rpm, is exactly the same as in figure 70 concerning the out-of-phase in-line engine. The variations of torque in the two out-of-phase engines (boxer and in-line) are the same because the two components of the total torque (torque due to the inertia forces and torque due to the gas pressure) are equal in the two out-of-phase engines.

Since the variations of torque are the same as in the shorter stroke out-of-phase in-line engine, the average torque and the variation of energy during two rotations of the crankshaft (presented in table 32) are also the same.



**Figure 73: Variation of torque in a shorter stroke out-of-phase boxer engine rotating at 4000 rpm**

Engine speed (rpm)	1000	2000	3000	4000
Average Torque (Nm)	71,1	160	145,8	128,1
Variation of energy (J)	1726,7	3684,7	3349,4	3278,5

**Table 32: Average torque and variation of energy for the shorter stroke out-of-phase boxer engine**

#### 5.4.2. Longer stroke

Results presented in table 33 are the same for the longer stroke out-of-phase boxer engine and for the longer stroke out-of-phase in-line engine.

Engine speed (rpm)	1000	2000	3000	4000
Average Torque (Nm)	78,6	176,9	161,2	141,6
Variation of energy (J)	1900,4	4047,2	3698,3	3670,8

**Table 33: Average torque and variation of energy for the longer stroke out-of-phase boxer engine**

### 5.5. Boxer twin-cylinder in-phase engine

#### 5.5.1. Shorter stroke

As the variations of torque are the same in the two out-of-phase engines, the variations of torque in the two in-phase engines are equal. So the values of torque and variation of energy during one rotation of the crankshaft (tables 34 and 35) can be deduced from the in-phase in-line engine results.

Engine speed (rpm)	1000	2000	3000	4000
Average Torque (Nm)	71,1	160	145,8	128,1
Variation of energy (J)	935,8	1968,3	1874,9	1982

**Table 34: Average torque and variation of energy for the shorter stroke in-phase boxer engine**

#### 5.5.2. Longer stroke

Engine speed (rpm)	1000	2000	3000	4000
Average Torque (Nm)	78,6	176,9	161,2	141,6
Variation of energy (J)	1036,2	2185,1	2100,2	2245,6

**Table 35: Average torque and variation of energy for the longer stroke in-phase boxer engine**

## 6. Comparison of twin-cylinder engines

### 6.1. Vibration point of view

#### 6.1.1. Comparison of different twin-cylinder arrangements

This section presents a comparison between the four different configurations of twin-cylinder engine (in-phase, out-of-phase in-line engine, in-phase and out-of-phase boxer engine). The detailed comparison is only carried out for the longer stroke set of data. Indeed, only the amplitude of the forces and moments curves is different between the longer and shorter stroke engine, the aspect of the different curves remains the same. So the conclusions are the same for the shorter and longer stroke engines.

The difficulty of the comparison comes from the mix of forces and moments in the engine. If there were only one of the two types of loading, the comparison would be easier. Furthermore the case of the forces is easy to deal with, because the values of the forces are absolute. They do not depend from the position where they are calculated or from the position of the different parts. So the smaller are the forces, the best is the balancing of the engine.

Unlikely, the value of the moments depends from the relative position of the different parts of the engine. The distance between the two cylinders is a very important parameter, especially in the boxer engine where this value is not limited by the piston diameter. So it could easily be reduced, which means also decreasing the moments. Finally, the position of the balance shafts is critical for the value of the different moments, especially if there is an odd number of balance shafts.

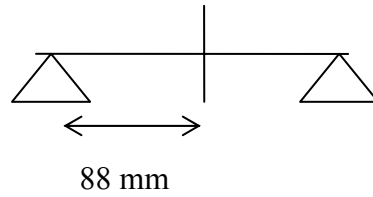
The unbalanced moments produce opposite forces on the engine mounts. It means that if the position of the engine mounts were known for all different configurations, we could calculate the total forces on each mount and it could be a good criterion to compare the engine.

We compare here for a simple example the effect of the first order X-force in the in-phase in-line engine and in the in-phase boxer engine. We make the assumption that the engine has two mounts placed symmetrically at 88 mm of the middle Z-plane of the engine (see figure 74). The first order X-force for one longer stroke cylinder is equal to 8253 N.

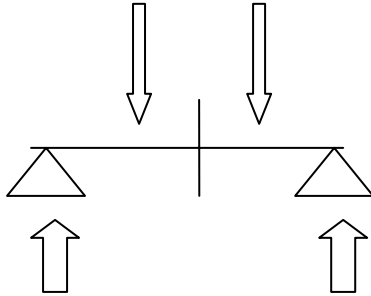
For the in-line engine (figure 75), the total force is 16505 N that is divided on the two mounts, it means 8253 N supported by each engine mounts because the system is symmetric.

For the boxer engine, the forces of the two cylinders are opposed and they create a torque of 726 Nm (figure 76). This moment is compensated by two equal and opposite forces, one on each engine mount. The value of one of this force is 4126 N, which is the half of the value found for the in-line engine. The fact that the distance between the engine mounts is bigger than the distance between the cylinder makes that the moment (two opposite forces) has a smaller impact on the engine mounts than the forces (two forces in the same direction). The bigger is the distance between the mounts, the smaller is the load on the mounts. And the distance between two engine mounts is at least the double of the distance between the cylinders. Thus it means that the moments are less penalizing (at least twice) than the equivalent unidirectional forces.

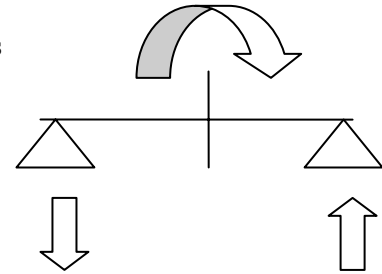




**Figure 74: Position of engine mounts**



**Figure 75: Effect of forces**



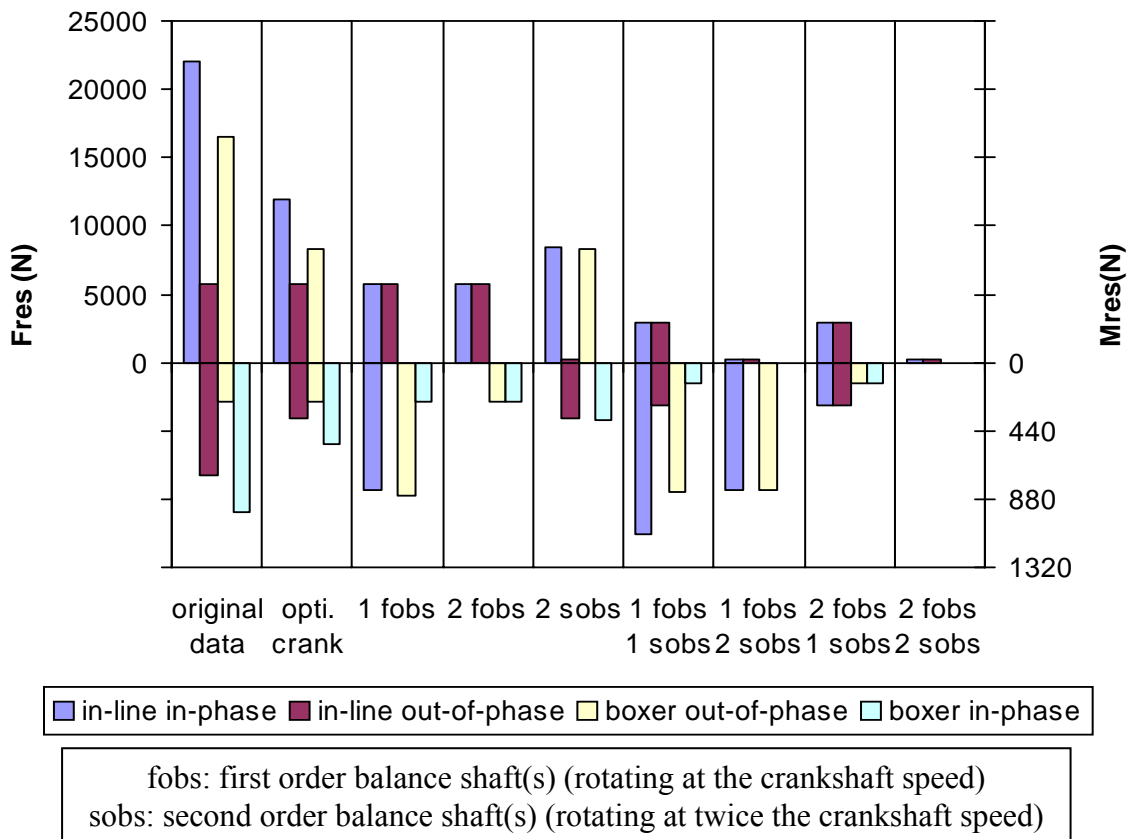
**Figure 76: Effect of moments**

Figure 77 shows a comparison of the maximum value of the resulting force and moment for all configurations of engine that we considered in this study.

In the reference data case of figure 77, we notice that the distribution of resulting forces and moments is the one expected from the equation section. Considering that moments are less penalizing than forces, an ordering of the four basic configurations (no optimization of the crankshaft and no balance shafts) of engine can be made. The intrinsically best balanced engine is the in-phase boxer engine because it generates no resulting forces, neither first nor second order. There are only first and second order moments. In second position, it is the out-of-phase in-line engine which generates second order forces and first order moments, but no first order forces. Then, it is the out-of-phase boxer engine with first order forces and second order moments. And finally, the in-phase in-line engine that has first and second order forces but no moments.

Figure 77 shows that with only the optimization of the crankshaft, the dominating loading (force or moment) is divided by nearly two for each configuration. Nevertheless, the basic load is in only one direction ( $F_x$  or  $M_y$ ), whereas the modification of the crankshaft leads to loadings in two directions ( $F_x, F_y$  or  $M_x, M_y$ ). These bidirectional forces could lead to some modifications to the engine mounts that are not isotropic.

Increasing the number of balance shafts brings globally a reduction of forces or moments (figure 77). With four balance shafts, all the engines are well-balanced (except effects of the fourth and higher orders but they are negligible). But it is a really complex solution and it is possible to reach a good engine balance with less balance shafts.



**Figure 77: Comparison of the resulting force and moment for different balancing systems of longer stroke twin-cylinder engine**

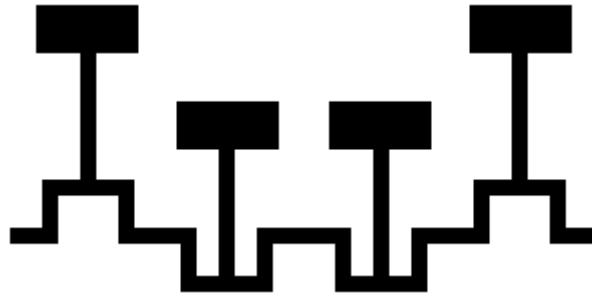
It is sometimes possible and interesting to use only one balance shaft instead of two to reduce forces or moments of one specific order. Of course, it does not cancel alone the entire load but it can cut it by two. For first order forces or moments, the counterweight of the crankshaft can play the role of the second balance shaft in order to cancel entirely the load. This solution is not well-adapted to configurations with first order forces (in-phase in-line engine and out-of-phase boxer engine). Because the non-symmetrical position of the crank and the balance shaft creates an important moment around Z-axis (see figure 77). But it works very well with configurations having first order moment (out-of-phase in-line engine and in-phase boxer engine), where the double balance shaft do not create free rolling moments.

### 6.1.2. Comparison with a four-cylinder engine

In the previous sections, different solutions were considered to reduce the forces and moments inside the engine. Some solutions lead to values of forces and moments close or even equal to zero but in return, they are complicated and expensive. So, the question is: “what are acceptable values of forces and moments”. To answer this question, we decide to study the inertia forces of a traditional four-cylinder engine and to compare it to our solutions.

#### 6.1.2.1. Description of the four cylinders engine

The engine is a conventional four-cylinder in-line engine with a classic configuration of the crankshaft (see figure 78 [MEMETEAU 1997, pp.79]). The characteristics of its pistons and its cylinders are identical to the one of the longer stroke twin-cylinder engine (see table 1).



**Figure 78: Crankshaft of the four-cylinder engine**

We notice that the configuration of the four-cylinder engine is equivalent to two out-of-phase in-line twin-cylinder engines placed face-to-face. The table 36 gives the maximum values of forces and moments for the four-cylinder engine rotating at 4000 rpm (the graphics showing all the forces and moments are given in the appendix B). As two of the four cylinders have a phase shift of 180 degrees with the two others cylinders. Their first order forces are always equal and opposite. So the total first order forces are equal to zero but the higher orders forces are not null. Since the crankshaft and the cylinder bank are symmetrical with respect to the middle of the engine, the moments in the engine are null.

As the twin-cylinder engine has twice less cylinders than the four-cylinder one, its horsepower and torque are also the half of the ones of the four-cylinder. The comparison has to be made between engines of the same horsepower and torque. So the inertia forces of the four-cylinder engine are divided by two (see table 37) to give the reference level that we want to reach for our twin-cylinder engine. The inertia loadings of our reference engine are only composed of second and higher order forces.

$F_{x,max}$ (N)	11587,78
$F_{y,max}$ (N)	0,00
$F_{res,max}$ (N)	11587,78
$\Delta F_{res}$ (N)	11519,65
$M_{x,max}$ (Nm)	0,00
$M_{y,max}$ (Nm)	0,00
$M_{z,max}$ (Nm)	0,00
$M_{res,max}$ (Nm)	0,00
$\Delta M_{res}$ (Nm)	0,00

**Table 36: Maximum value of forces and moments for longer stroke in-line four-cylinder engine**

$F_{x,max}$ (N)	5793,89
$F_{y,max}$ (N)	0,00
$F_{res,max}$ (N)	5793,89
$\Delta F_{res}$ (N)	5759,81
$M_{x,max}$ (Nm)	0,00
$M_{y,max}$ (Nm)	0,00
$M_{z,max}$ (Nm)	0,00
$M_{res,max}$ (Nm)	0,00
$\Delta M_{res}$ (Nm)	0,00

Table 37: Maximum value of forces and moments for the reference four-cylinder engine

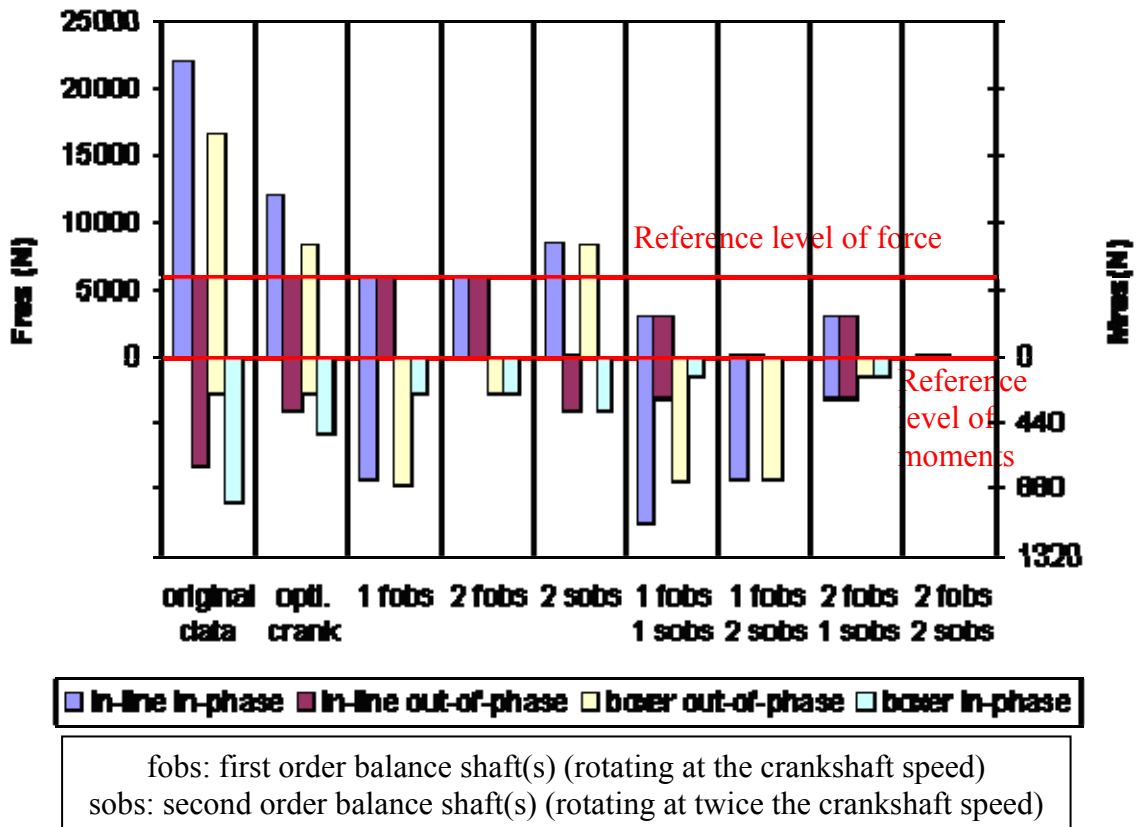


Figure 79: Resulting force and moment for different balancing systems of longer stroke twin-cylinder engine and reference level

#### 6.1.2.2. In-line in-phase engine

The figure 79 and the table 17 give all the forces and moments for all the different configurations of in-line in-phase engine under study. We notice that the simplest configuration that gives identical or better results than the reference engine is the one with two first order balance shafts. If we use two balance shafts (unbalance mass = 0,04703 kg\*m), the in-line in-phase twin cylinder engine produces exactly the same forces and moments than the reference engine.

#### 6.1.2.3. In-line out-of-phase engine

The figure 79 and the table 22 give all the forces and moments for all the different configurations of in-line out-of-phase engine that we study. We notice that the simplest configuration that gives identical or better results than the reference engine is the one with one modified crankshaft and one first order double balance shaft. If we use this crankshaft (unbalance mass of one half of the crankshaft = 0,04353 kg\*m) and this balance shaft (unbalance mass of one half of the double balance shaft = 0,023515 kg\*m.), the in-line out-of-phase twin-cylinder engine produces exactly the same forces and moments than the reference engine.

#### 6.1.2.4. Boxer out-of-phase engine

The figure 79 and the table 24 show that a very good configuration for out-of-phase boxer engine is the one with two first order balance shafts because they cancel the first order forces. It remains only the second and higher order moments that are rather small. Nevertheless these moments can be reduced by bringing closer the piston centers. That can be achieved by using a system with a connecting rod in shape of fork. In this case, the distance become null and so does the moments.

$F_{x,max}$ (N)	0,09
$F_{y,max}$ (N)	0,00
$F_{res,max}$ (N)	0,09
$\Delta F_{res}$ (N)	0,09
$M_{x,max}$ (Nm)	0,00
$M_{y,max}$ (Nm)	43,46
$M_{z,max}$ (Nm)	0,00
$M_{res,max}$ (Nm)	43,46
$\Delta M_{res}$ (Nm)	43,20

**Table 38: Maximum values of forces and moments for the out-of-phase boxer engine with two first order balance shaft and a reduced distance between bore centers.**

Alternatively, one can use two normal connecting rods, on the same crankpin, next to each other. In this case, the distance between bore centers is assumed to be approximately fifteen millimeters. The values of forces and moments for this configuration (two first order balance shafts and distance between bore centers equal to fifteen millimeters) are given in the table 38.

#### 6.1.2.5. Boxer in-phase engine

The figure 79 and the table 26 show that one interesting configuration for in-phase boxer engine is one with a modified crankshaft (unbalance mass = 0,04875 kg\*m) and no balance shaft. The only loading inside the engine is a multi-orders bidirectional moment of maximum values equal to 523 Nm.

Nevertheless these moments can be reduced by bringing closer the piston centers. In this case, the two connecting rods can not be on the same crankpin. So, we have to take into account the size of different parts of the crankshaft (two crank arms and one journal) to determine the minimum distance between the two piston centers. This distance is assumed to be approximately sixty millimeters. The table 39 shows the values of forces and moments in the boxer in-phase engine with a modified crankshaft (unbalance mass = 0,04875 kg\*m) and a reduced distance between bore centers. This configuration gives values of moments that are small enough (if we suppose that the engine mounts are spaced of 176 mm, the double of the distance between bore centers, the forces produced by the moments on the mounts are 4053 N which is smaller than the force of the reference engine).

$F_{x,max}$ (N)	0,00
$F_{y,max}$ (N)	0,00
$F_{res,max}$ (N)	0,00
$\Delta F_{res}$ (N)	0,00
$M_{x,max}$ (Nm)	302,52
$M_{y,max}$ (Nm)	198,60
$M_{z,max}$ (Nm)	0,00
$M_{res,max}$ (Nm)	356,68
$\Delta M_{res}$ (Nm)	328,10

**Table 39: Maximum values of forces and moments for the out-of-phase boxer engine with a modified crankshaft and a reduced distance between bore centers.**

## 6.2. Gas pressure effect point of view

In this section, we take care of the effect deriving from the gas pressure (peak of forces or moments, average torque, variations of torque, firing order...) in addition to the balancing of inertia forces.

At first, we consider the out-of-phase engines, both in-line and boxer. The main drawback of these configurations is the variable crankshaft angle between the two power strokes. These variations lead to important variations of torque and to a torque periodicity equal to 720 degrees instead of 360 degrees. These two reasons make that, in the out-of-phase configurations, the flywheel has to be oversized. The energy to be absorbed and released is nearly the double than in an in-phase configuration. Moreover, the non-periodic injection gives two very close ignitions followed by a blank which could be very dissonant. And an unpleasant sonority can be a real restraint for the introduction to the market of such an engine.

The effect of the gas pressure is the same in the in-phase in-line engine and in the in-phase boxer engine. The variations of torque and energy are equal in both cases. So the choice is purely a matter of balancing and has been discussed in the previous section. The boxer engine has intrinsically its forces balanced. And its moments could be reduced easily by bringing closer the axes of the cylinders, optimizing the crankshaft and, if it is not enough balanced yet, using one double balance shaft. To cancel completely the first and second order forces in an in-line in-phase engine, it needs four balance shafts, which is generally too complex.

Two different sets of data has been simulated, one with a shorter stroke and one with a longer one. The longer stroke engine presents the advantage of having a higher torque than the shorter stroke one (10,5 % higher). But this engine has higher inertia forces or moments (13 % higher) to balance and a higher variation of energy to be absorbed by the flywheel (10 % higher). So if the shorter stroke engine is enough powerful for the car in which we want to use it, the shorter stroke engine is the best solution. But if more power is needed, the longer stroke engine may be used because it provides more than 10 % of additional torque but it requires a bigger flywheel and it generates more vibrations.

## 7. Sensitivity analysis

In this section, different parameters such as the mass of the piston, the mass and length of the connecting rod and the distance between the cylinder axes are modified. The effect of these parameters variations on the resulting forces and moments is observed. The goals are to determine if a significant reduction of the loads can be achieved with small variations of these design parameters.

All these modifications have an impact on the resulting forces or moments. The sensitivity analysis is made with respect to the **reference configurations of longer stroke twin-cylinder engine**. All variations are calculated with the engine rotating at 4000 rpm.

### 7.1. Mass of the piston

#### 7.1.1. In-phase in-line twin-cylinder engine

The table 40 and figure 80 show the influence of the piston mass on the resulting moment and force.

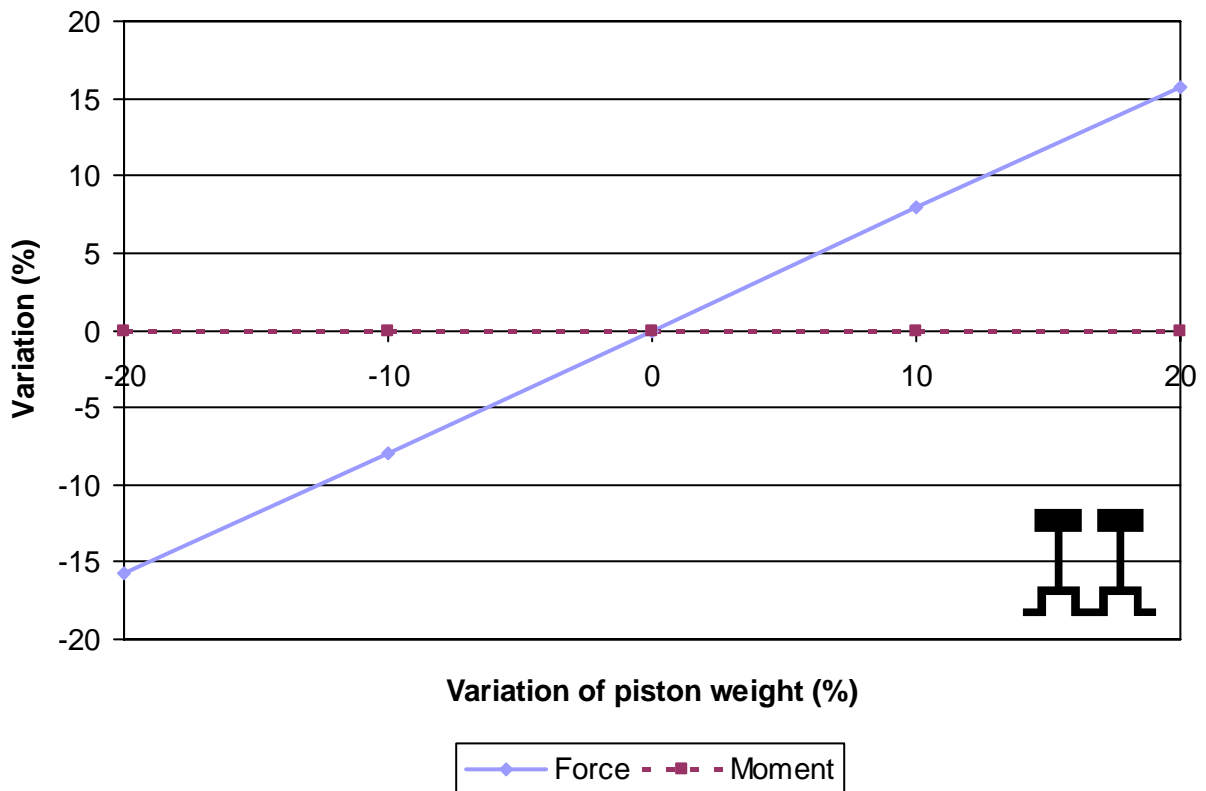
The amplitude of the resulting forces varies linearly with the mass of the piston. The slope of this variation is smaller than one. In fact, the percentage of variation of forces is equal to the percentage of variation of the total oscillating mass (mass of the piston and one third of the connecting rod mass). A decrease of ten percents of the total oscillating mass gives a decrease of ten percents of the resulting moments. As the mass of the piston is only one part of the total oscillating mass, a decrease of ten percents of the piston mass gives a decrease of less than ten percents of the total oscillating mass and thus a reduction of less than ten percents of the resulting forces.

The in-phase in-line engine produces no moment for any values of piston mass.



Piston mass (kg)	0,6203	0,6979	0,7754	0,8529	0,9305
Variation of the piston mass (%)	-20,0	-10,0	0,0	10,0	20,0
Resulting force (N)	18513	20243	21973	23702	25432
Variation of resulting force (%)	-15,7	-7,9	0,0	7,9	15,7
Resulting moment (Nm)	0	0	0	0	0
Variation of resulting moment (%)	0,0	0,0	0,0	0,0	0,0

**Table 40: Impact of the piston mass for the longer stroke in-phase in-line engine rotating at 4000 rpm**



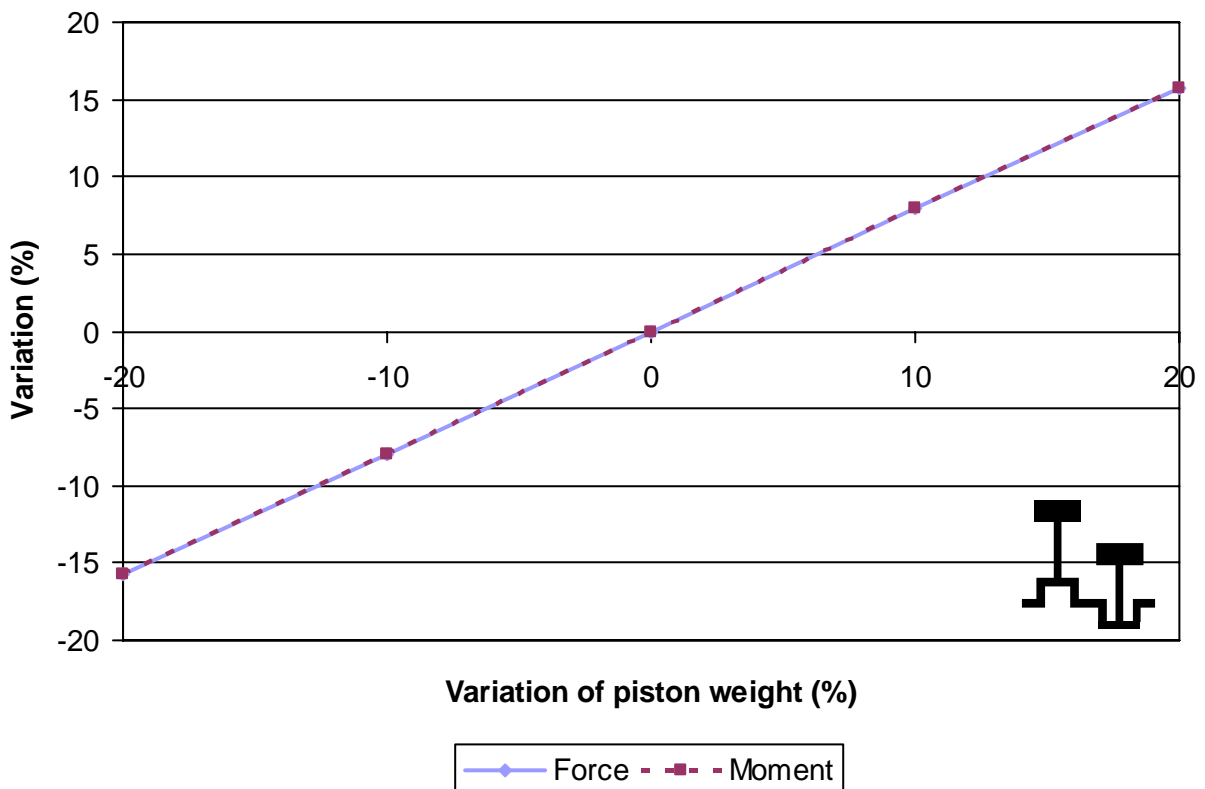
**Figure 80: Impact of the piston mass for the longer stroke in-phase in-line engine rotating at 4000 rpm**

### 7.1.2. Out-of-phase in-line twin-cylinder engine

The table 41 and figure 81 show the influence of the piston mass on the resulting moment and force for the longer stroke out-of-phase in-line engine. As for the in-phase engine, the amplitude of the resulting forces varies linearly with the mass of the piston and the slope of this variation is the same. But in this case, there is also a variation of moment. The resulting moment behaves like the resulting force with respect to the variation of piston mass.

Piston mass (kg)	0,6203	0,6979	0,7754	0,8529	0,9305
Variation of the piston mass (%)	-20,0	-10,0	0,0	10,0	20,0
Resulting force (N)	4882	5338	5794	6250	6706
Variation of resulting force (%)	-15,7	-7,9	0,0	7,9	15,7
Resulting moment (Nm)	612	669	726	783	841
Variation of resulting moment (%)	-15,7	-7,9	0,0	7,9	15,7

**Table 41: Impact of the piston mass for the longer stroke out-of-phase in-line engine rotating at 4000 rpm**



**Figure 81: Impact of the piston mass for the longer stroke out-of-phase in-line engine rotating at 4000 rpm**

### 7.1.3. Out-of-phase twin-cylinder boxer engine

The table 42 and figure 82 show the influence of the piston mass on the resulting moment and force for the longer stroke out-of-phase boxer engine. The percentages of variations of force and moments are the same than in the case of the out-of-phase in-line engine. The only difference comes from the absolute values because, in this case, the engine produces first order forces and second order moments instead of second order forces and first order moment for the in-line engine.

Piston mass (kg)	0,6203	0,6979	0,7754	0,8529	0,9305
Variation of the piston mass (%)	-20,0	-10,0	0,0	10,0	20,0
Resulting force (N)	13906	15205	16504	17804	19103
Variation of resulting force (%)	-15,7	-7,9	0,0	7,9	15,7
Resulting moment (Nm)	215	235	255	275	295
Variation of resulting moment (%)	-15,7	-7,9	0,0	7,9	15,7

Table 42: Impact of the piston mass for the longer stroke out-of-phase boxer engine rotating at 4000 rpm

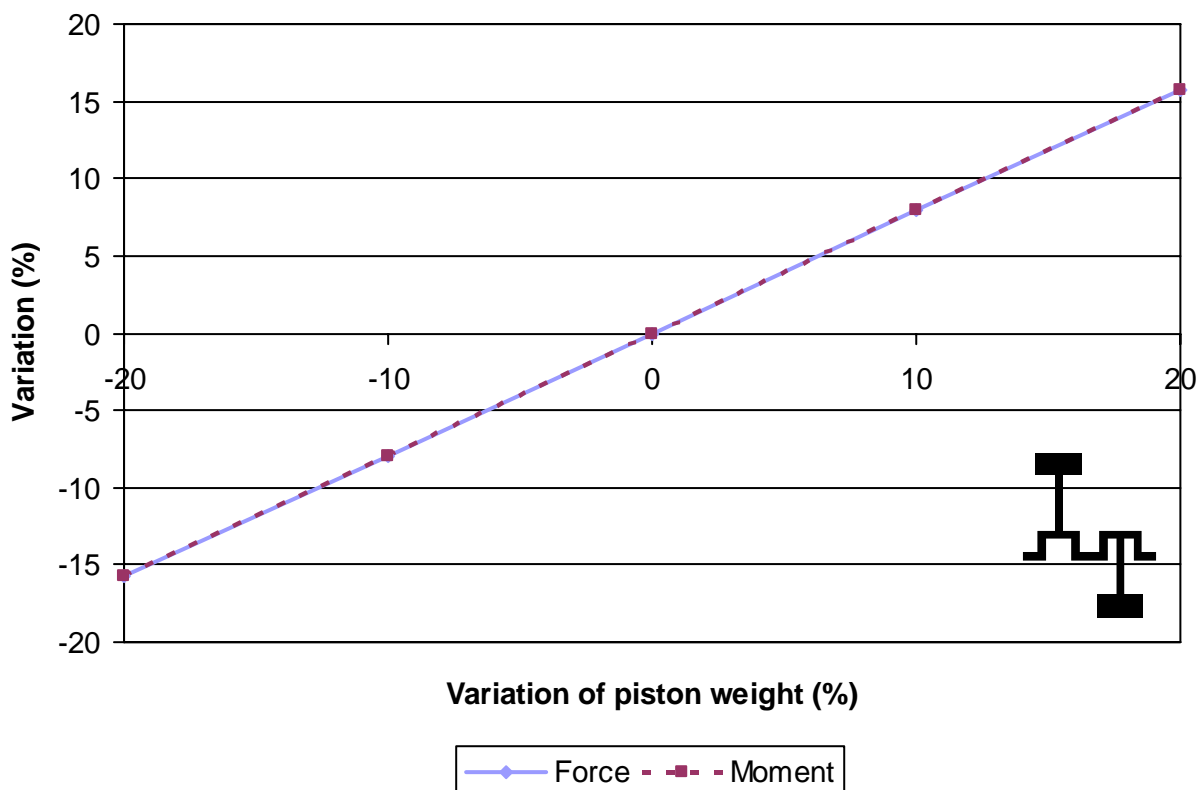


Figure 82: Impact of the piston mass for the longer stroke out-of-phase boxer engine rotating at 4000 rpm

### 7.1.4. In-phase twin-cylinder boxer engine

The table 43 and figure 83 show the influence of the piston mass on the resulting moment and force for the longer stroke in-phase boxer engine. For the in-phase boxer engine, there are no variations of force when the mass of the piston changes because this engine does not produce any free forces.

Piston mass (kg)	0,6203	0,6979	0,7754	0,8529	0,9305
Variation of the piston mass (%)	-20,0	-10,0	0,0	10,0	20,0
Resulting force (N)	0	0	0	0	0
Variation of resulting force (%)	0,0	0,0	0,0	0,0	0,0
Resulting moment (Nm)	815	891	967	1043	1119
Variation of resulting moment (%)	-15,7	-7,9	0,0	7,9	15,7

Table 43: Impact of the piston mass for the longer stroke in-phase boxer engine rotating at 4000 rpm

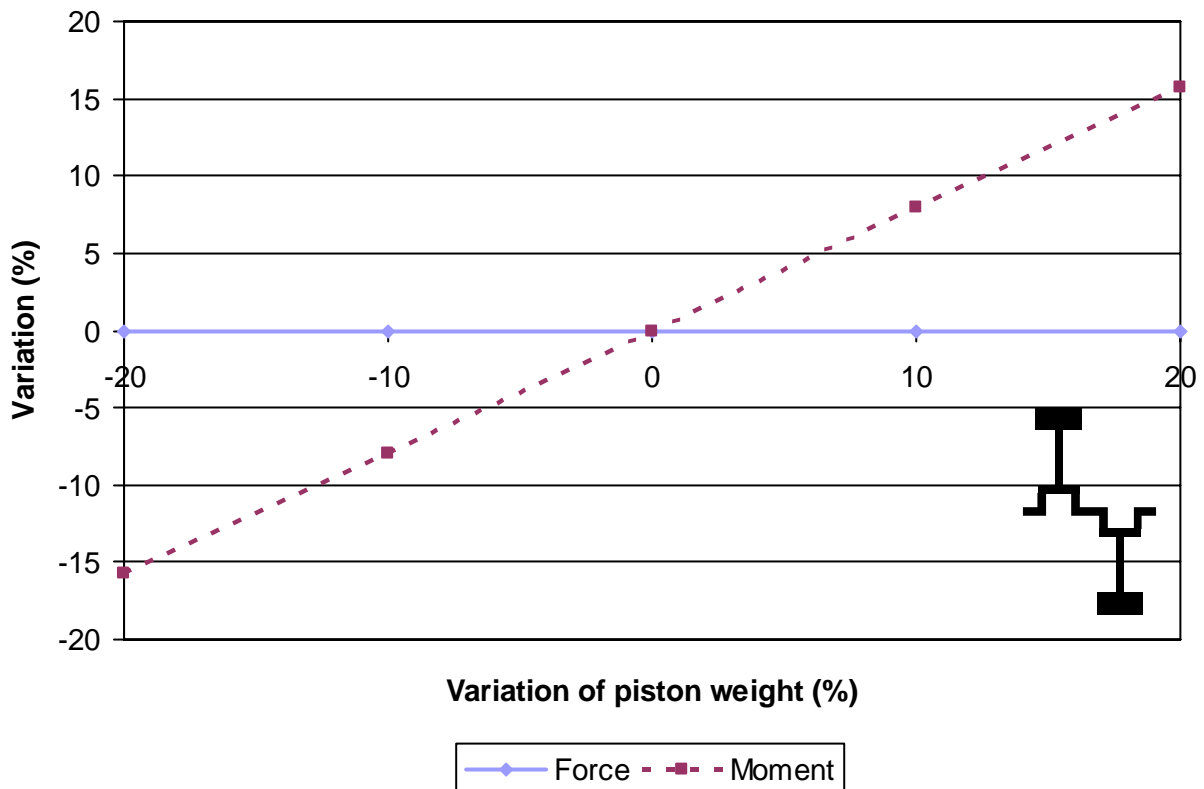


Figure 83: Impact of the piston mass for the longer stroke in-phase boxer engine rotating at 4000 rpm

## 7.2. Mass of the connecting rod

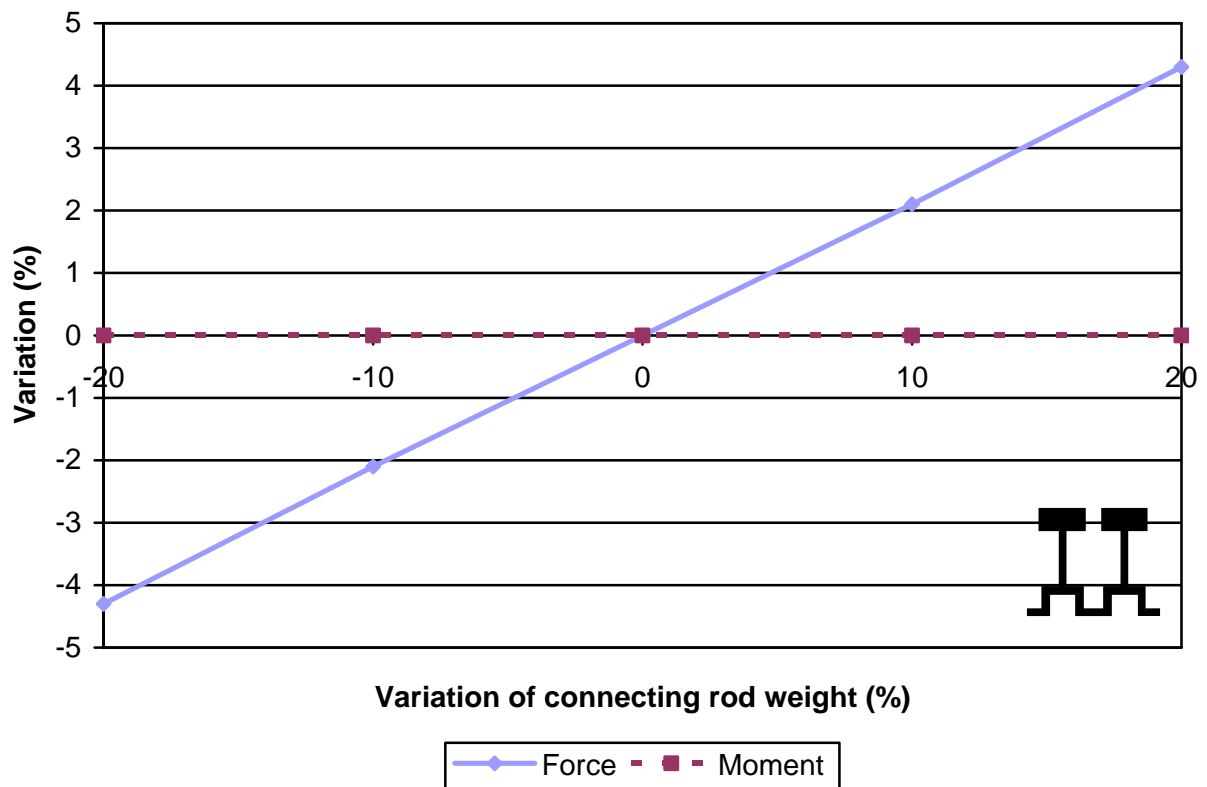
In this section, we modify the mass of the connecting rod. As the counterweights of the crankshaft are designed to cancel the force created by the revolution of the crankshaft and the connecting rod, each time the mass of the connecting rod is modified, the counterweights have to be recalculated and modified.

### 7.2.1. In-phase in-line twin-cylinder engine

The table 44 and figure 84 show the influence of the connecting rod mass on the resulting moment and force for the in-phase in-line engine. As for the variation of the piston mass, a decrease of the connecting rod mass leads to a decrease of magnitude of the resulting forces. Since the relative mass of the connecting rod in the total oscillating mass is smaller than the piston mass, its impact is less important. If we reduce the mass of the connecting rod and the mass of the piston at the same time, we will obtain exactly the same percentage of reduction of the resulting force.

Connecting rod mass (kg)	0,5030	0,5658	0,6287	0,6916	0,7544
Variation of the rod mass (%)	-20,0	-10,0	0,0	10,0	20,0
Resulting force (N)	21038	21505	21973	22440	22908
Variation of resulting force (%)	-4,3	-2,1	0,0	2,1	4,3
Resulting moment (Nm)	0	0	0	0	0
Variation of resulting moment (%)	0,0	0,0	0,0	0,0	0,0

**Table 44: Effect of the connecting rod mass on the forces and moments for the longer stroke in-phase in-line engine rotating at 4000 rpm**



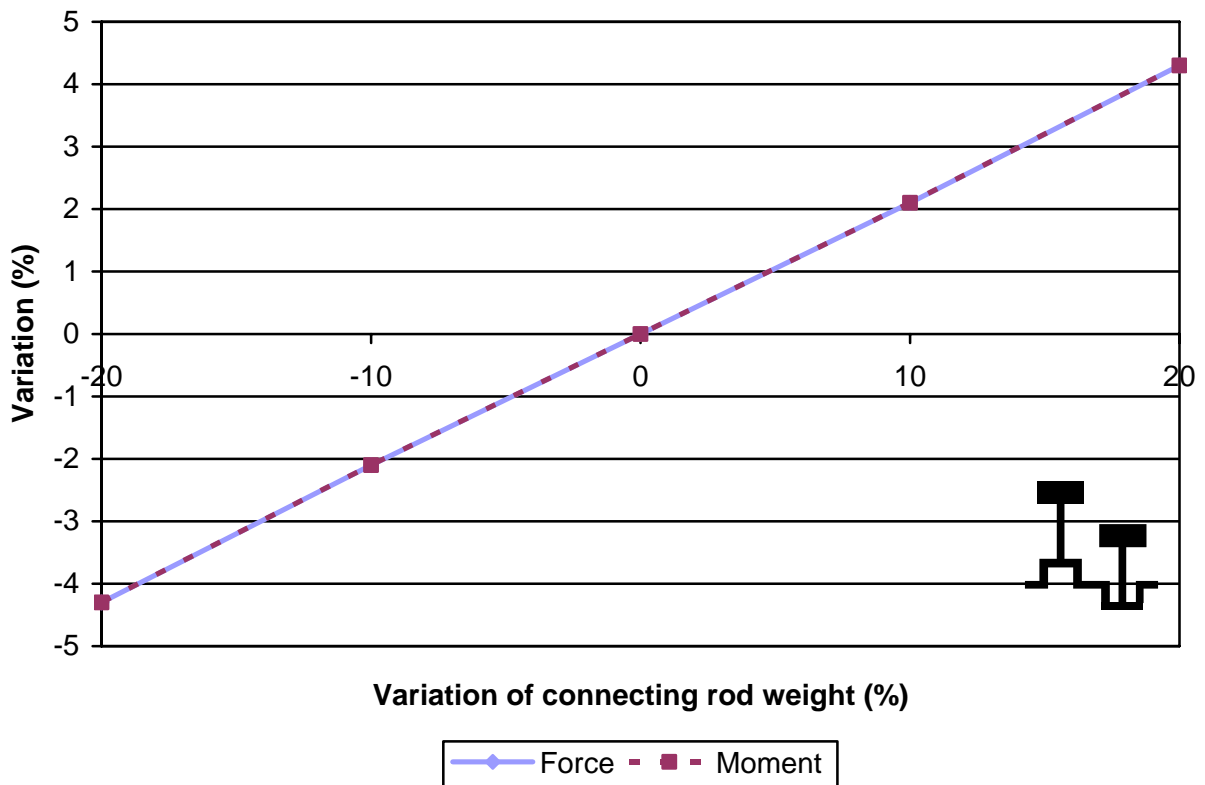
**Figure 84: Effect of the connecting rod mass on the forces and moments for the longer stroke in-phase in-line engine rotating at 4000 rpm**

### 7.2.2. Out-of-phase in-line twin-cylinder engine

The table 45 and figure 85 show the influence of the connecting rod mass on the resulting moment and force for the out-of-phase in-line engine.

Connecting rod mass (kg)	0,5030	0,5658	0,6287	0,6916	0,7544
Variation of the rod mass (%)	-20,0	-10,0	0,0	10,0	20,0
Resulting force (N)	5547	5671	5794	5917	6040
Variation of resulting force (%)	-4,3	-2,1	0,0	2,1	4,3
Resulting moment (Nm)	695	711	726	742	757
Variation of resulting moment (%)	-4,3	-2,1	0,0	2,1	4,3

**Table 45: Effect of the connecting rod mass on the forces and moments for the longer stroke out-of-phase in-line engine rotating at 4000 rpm**



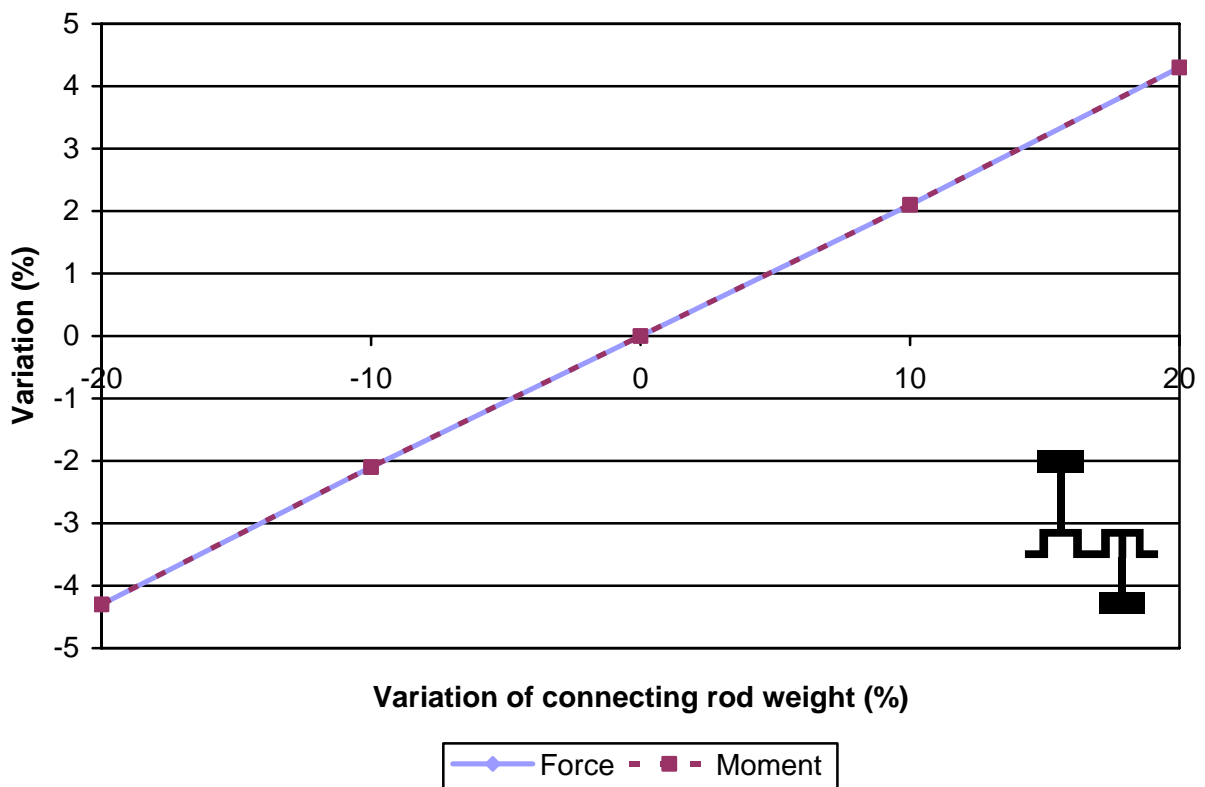
**Figure 85: Effect of the connecting rod mass on the forces and moments for the longer stroke out-of-phase in-line engine rotating at 4000 rpm**

### 7.2.3. Out-of-phase twin-cylinder boxer engine

The table 46 and figure 86 show the influence of the connecting rod mass on the resulting moment and force for the out-of-phase boxer engine.

Connecting rod mass (kg)	0,5030	0,5658	0,6287	0,6916	0,7544
Variation of the rod mass (%)	-20,0	-10,0	0,0	10,0	20,0
Resulting force (N)	15802	16153	16504	16856	17207
Variation of resulting force (%)	-4,3	-2,1	0,0	2,1	4,3
Resulting moment (Nm)	244	250	255	260	266
Variation of resulting moment (%)	-4,3	-2,1	0,0	2,1	4,3

**Table 46: Effect of the connecting rod mass on the forces and moments for the longer stroke out-of-phase boxer engine rotating at 4000 rpm**



**Figure 86: Effect of the connecting rod mass on the forces and moments for the longer stroke out-of-phase boxer engine rotating at 4000 rpm**

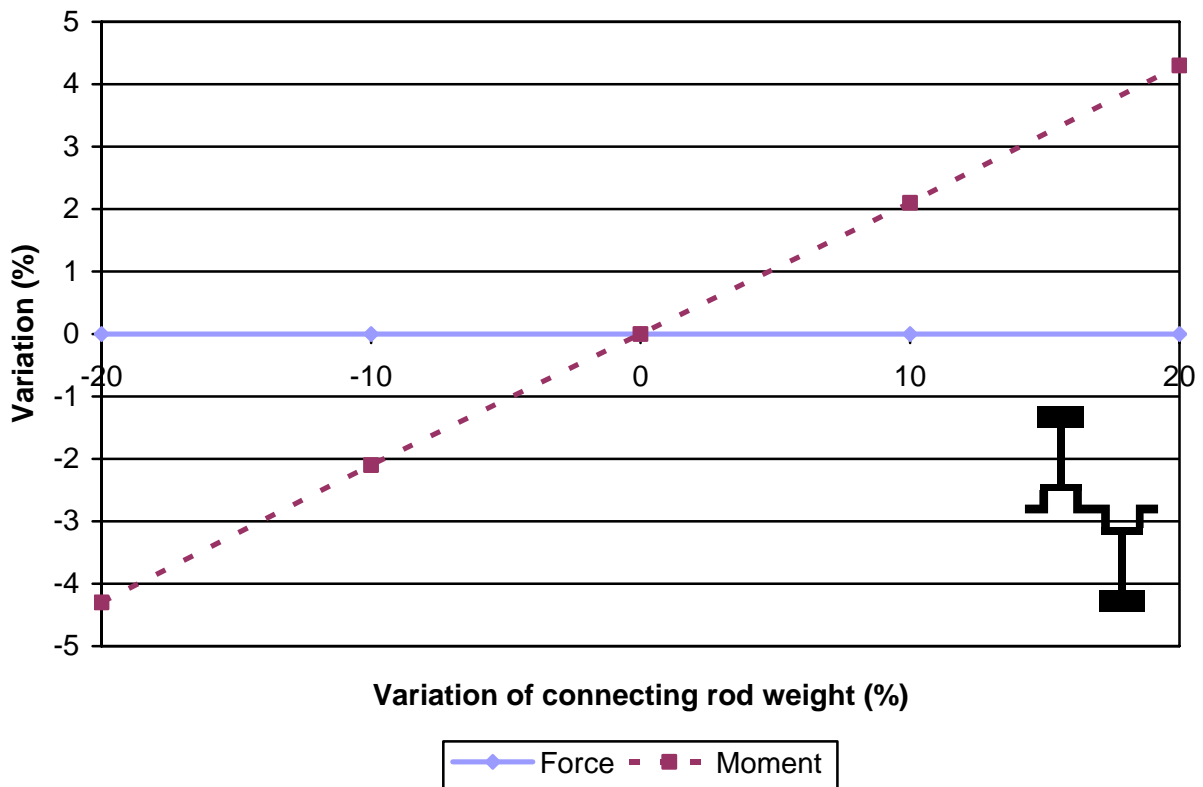


### 7.2.4. In-phase twin-cylinder boxer engine

The table 47 and figure 87 show the influence of the connecting rod mass on the resulting moment and force for the in-phase boxer engine.

Connecting rod mass (kg)	0,5030	0,5658	0,6287	0,6916	0,7544
Variation of the rod mass (%)	-20,0	-10,0	0,0	10,0	20,0
Resulting force (N)	0	0	0	0	0
Variation of resulting force (%)	0,0	0,0	0,0	0,0	0,0
Resulting moment (Nm)	926	946	967	987	1008
Variation of resulting moment (%)	-4,3	-2,1	0,0	2,1	4,3

**Table 47: Effect of the connecting rod mass on the forces and moments for the longer stroke in-phase boxer engine rotating at 4000 rpm**



**Figure 87: Effect of the connecting rod mass on the forces and moments for the longer stroke in-phase boxer engine rotating at 4000 rpm**

## 7.3. Length of the connecting rod

### 7.3.1. In-phase in-line twin-cylinder engine

The table 48 and figure 88 show the influence of the connecting rod length on the resulting moment and force for the in-phase in-line engine.

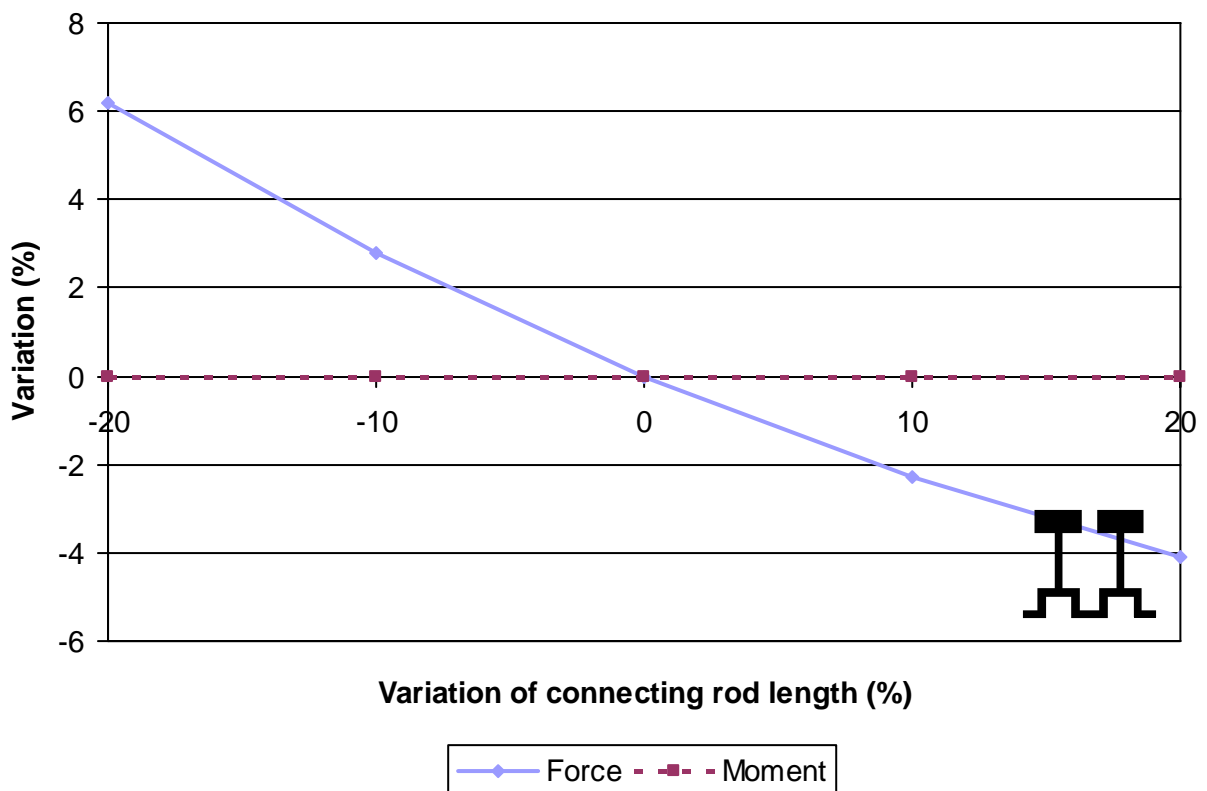
We notice that an increase of the connecting rod length leads to a slight and non-linear decrease of the resulting forces. By looking at the equations (1) to (13), we notice that the length of the connecting rod appears only in the stroke to connecting rod ratio. And the stroke to connecting rod ratio is used with different exponents in the high order terms. So the variation of forces is non-linear with respect to the variation of connecting rod length.

The length of the connecting rod has no influence neither on the first order forces like in the out-of-phase boxer engine (figure 90) nor on the first order moment like in the out-of-phase in-line engine(see figure 89).

But the variation of second order forces (figure 89) or moments (figure 90) is very important.

Connecting rod length (m)	0,1152	0,1296	0,1440	0,1584	0,1728
Variation of the rod length (%)	-20,0	-10,0	0,0	10,0	20,0
Resulting force (N)	23331	22578	21973	21477	21063
Variation of resulting force (%)	6,2	2,8	0,0	-2,3	-4,1
Resulting moment (Nm)	0	0	0	0	0
Variation of resulting moment (%)	0,0	0,0	0,0	0,0	0,0

**Table 48: Effect of the connecting rod length on the forces and moments for the longer stroke in-phase in-line engine rotating at 4000 rpm**



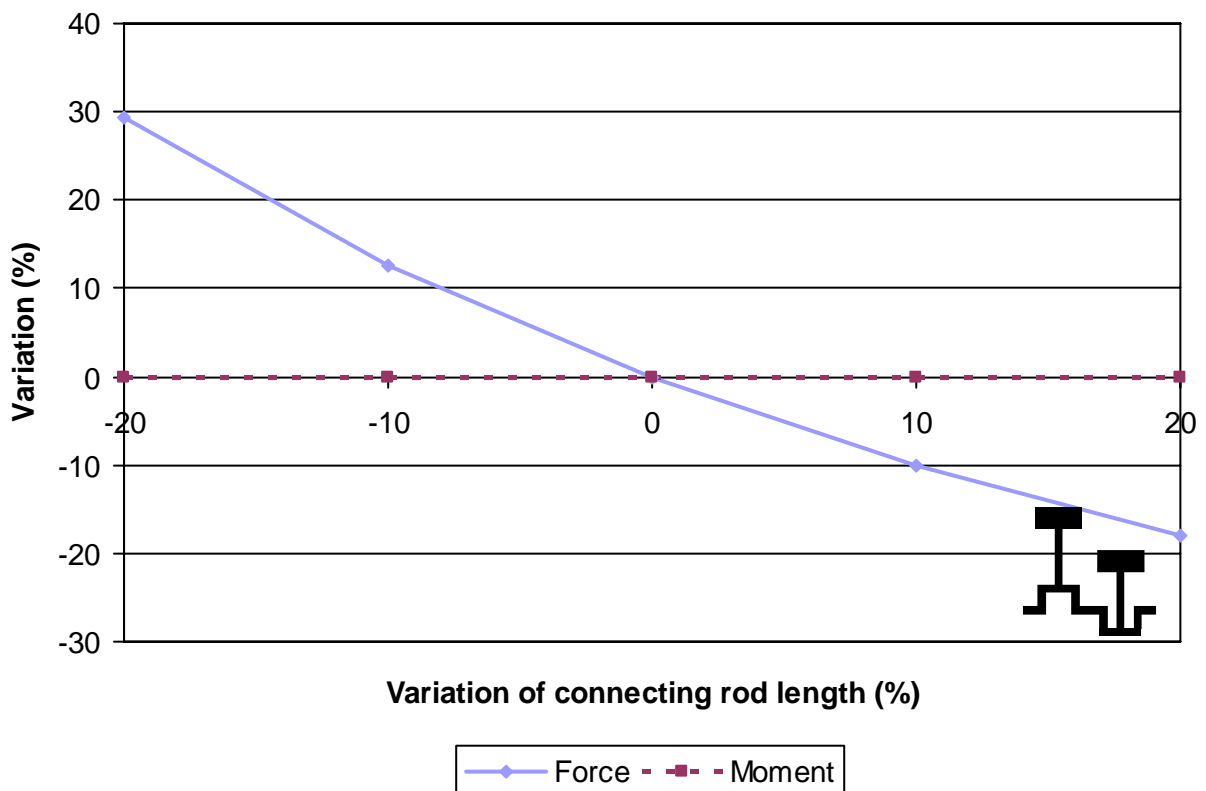
**Figure 88: Effect of the connecting rod length on the forces and moments for the longer stroke in-phase in-line engine rotating at 4000 rpm**

### 7.3.2. Out-of-phase in-line twin-cylinder engine

The table 49 and figure 89 show the influence of the connecting rod length on the resulting moment and force for the out-of-phase in-line engine.

Connecting rod length (m)	0,1152	0,1296	0,1440	0,1584	0,1728
Variation of the rod length (%)	-20,0	-10,0	0,0	10,0	20,0
Resulting force (N)	7490	6528	5794	5214	4743
Variation of resulting force (%)	29,3	12,7	0,0	-10,0	-18,1
Resulting moment (Nm)	726	726	726	726	726
Variation of resulting moment (%)	0,0	0,0	0,0	0,0	0,0

**Table 49: Effect of the connecting rod length on the forces and moments for the longer stroke out-of-phase in-line engine rotating at 4000 rpm**



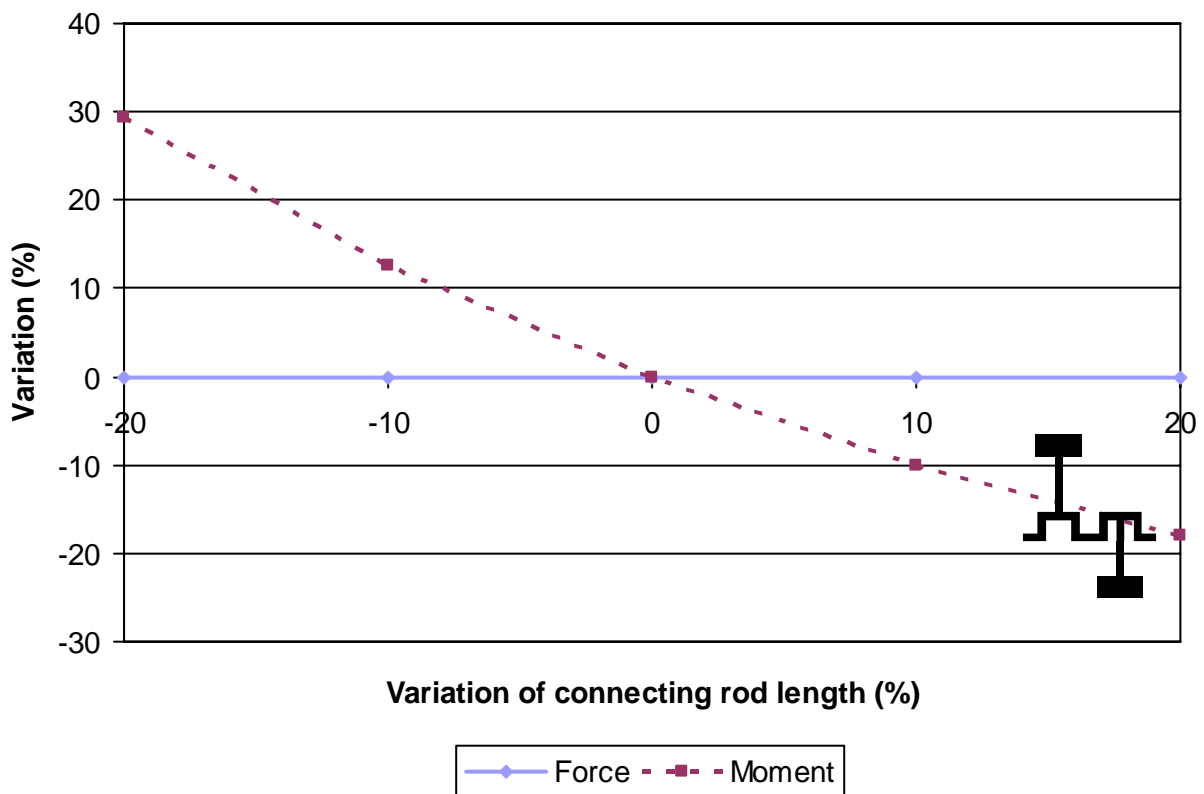
**Figure 89: Effect of the connecting rod length on the forces and moments for the longer stroke out-of-phase in-line engine rotating at 4000 rpm**

### 7.3.3. Out-of-phase twin-cylinder boxer engine

The table 50 and figure 90 show the influence of the connecting rod length on the resulting moment and force for the out-of-phase boxer engine.

Connecting rod length (m)	0,1152	0,1296	0,1440	0,1584	0,1728
Variation of the rod length (%)	-20,0	-10,0	0,0	10,0	20,0
Resulting force (N)	16504	16504	16504	16504	16504
Variation of resulting force (%)	0,0	0,0	0,0	0,0	0,0
Resulting moment (Nm)	330	287	255	229	209
Variation of resulting moment (%)	29,2	12,6	0,0	-10,0	-18,2

**Table 50: Effect of the connecting rod length on the forces and moments for the longer stroke out-of-phase boxer engine rotating at 4000 rpm**



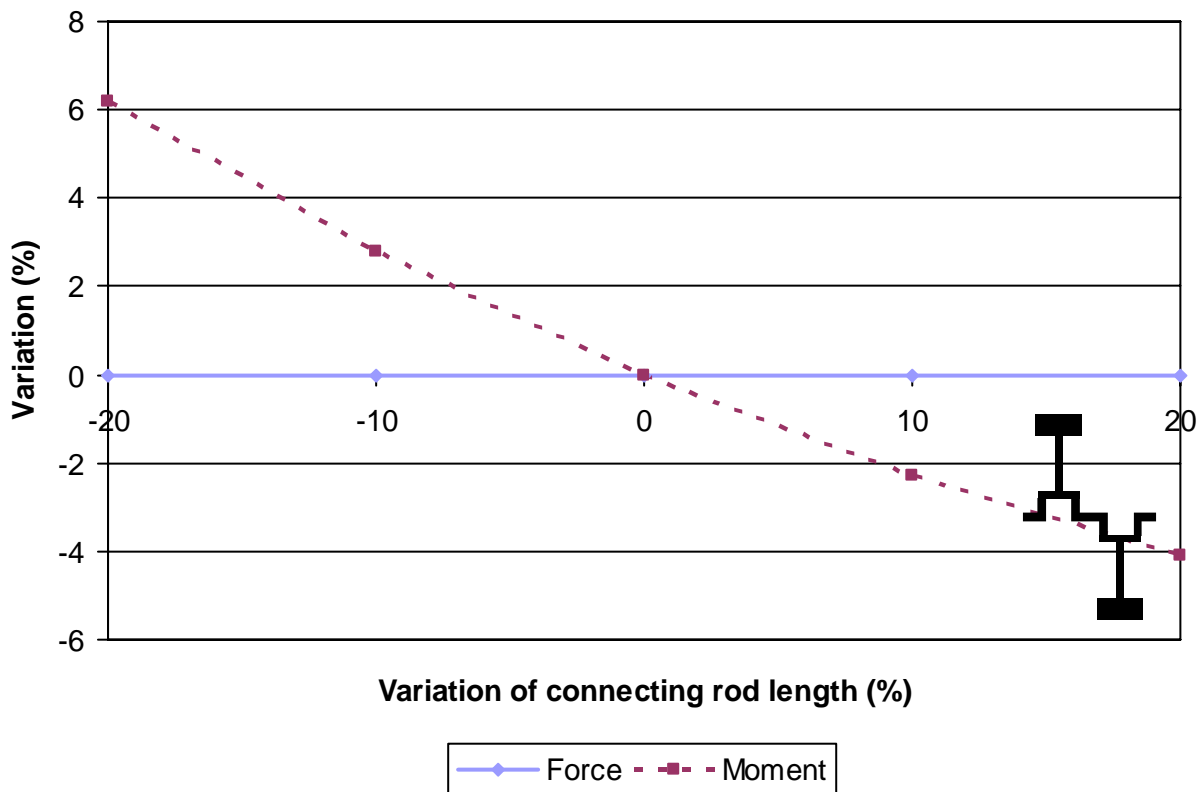
**Figure 90: Effect of the connecting rod length on the forces and moments for the longer stroke out-of-phase boxer engine rotating at 4000 rpm**

### 7.3.4. In-phase twin-cylinder boxer engine

The table 51 and figure 91 show the influence of the connecting rod length on the resulting moment and force for the in-phase boxer engine.

Connecting rod length (m)	0,1152	0,1296	0,1440	0,1584	0,1728
Variation of the rod length (%)	-20,0	-10,0	0,0	10,0	20,0
Resulting force (N)	0	0	0	0	0
Variation of resulting force (%)	0,0	0,0	0,0	0,0	0,0
Resulting moment (Nm)	1027	993	967	945	927
Variation of resulting moment (%)	6,2	2,8	0,0	-2,3	-4,1

**Table 51: Effect of the connecting rod length on the forces and moments for the longer stroke in-phase boxer engine rotating at 4000 rpm**



**Figure 91: Effect of the connecting rod length on the forces and moments for the longer stroke in-phase boxer engine rotating at 4000 rpm**

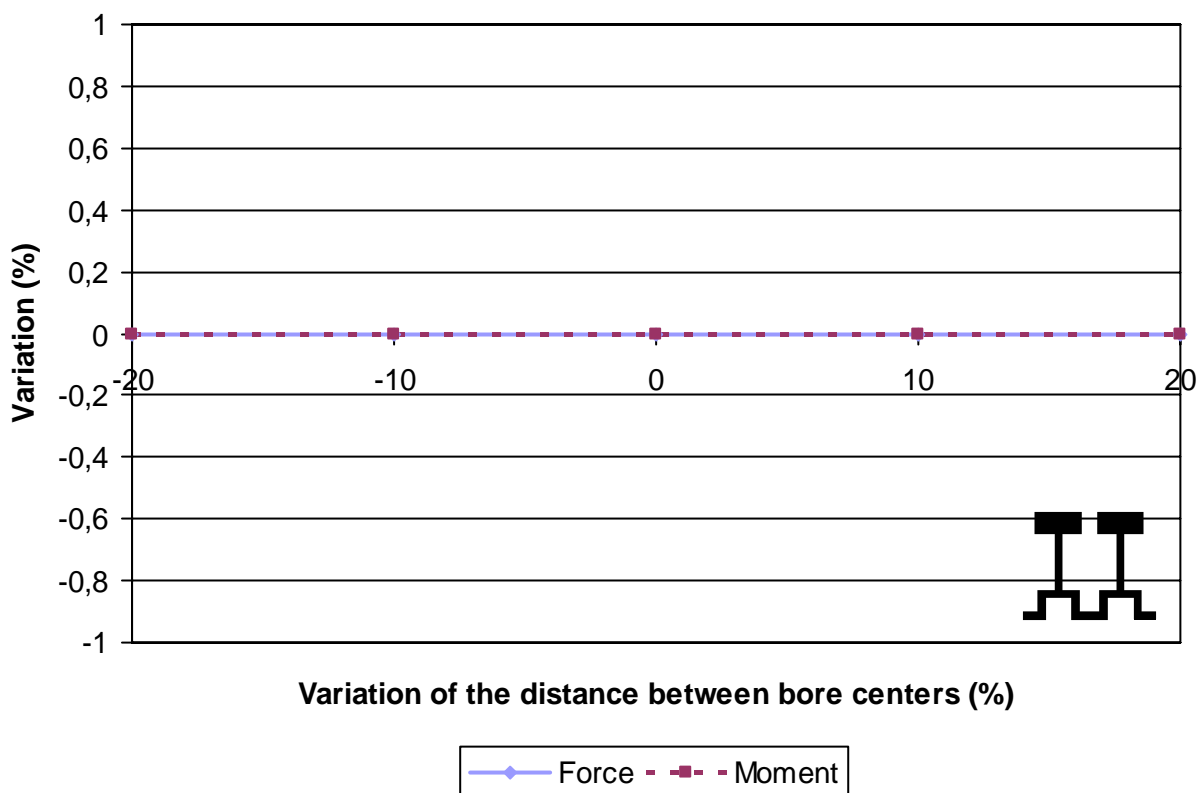
## 7.4. Distance between bore centers

### 7.4.1. In-phase in-line twin-cylinder engine

The table 52 and figure 92 show the influence of the distance between bore centers on the resulting moment and force for the in-phase in-line engine. The distance between bore centers has no influence on the forces generated by the engine.

Distance between bore centers (m)	0,0704	0,0792	0,0880	0,0968	0,1056
Variation of the distance (%)	-20,0	-10,0	0,0	10,0	20,0
Resulting force (N)	21973	21973	21973	21973	21973
Variation of resulting force (%)	0,0	0,0	0,0	0,0	0,0
Resulting moment (Nm)	0	0	0	0	0
Variation of resulting moment (%)	0,0	0,0	0,0	0,0	0,0

**Table 52: Effect of the distance between bore centers on the forces and moments for the longer stroke in-phase in-line engine rotating at 4000 rpm**



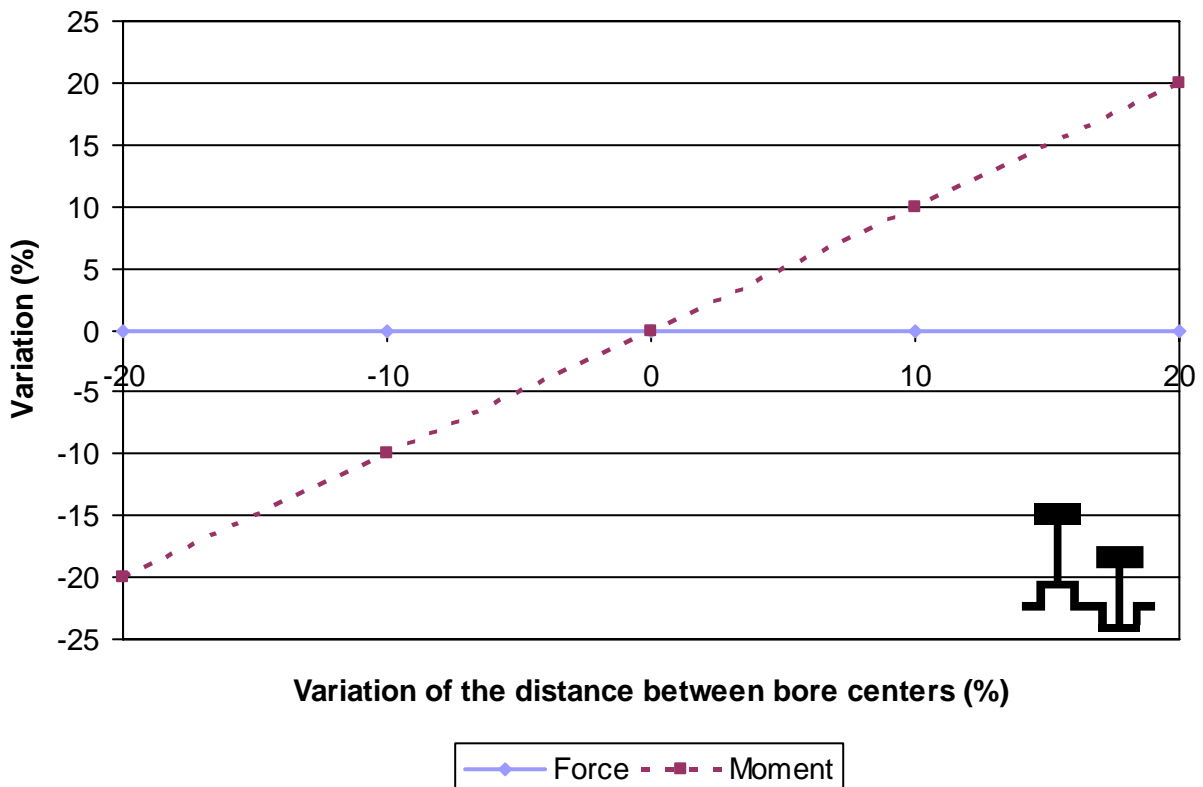
**Figure 92: Effect of the distance between bore centers on the forces and moments for the longer stroke in-phase in-line engine rotating at 4000 rpm**

### 7.4.2. Out-of-phase in-line twin-cylinder engine

The table 53 and figure 93 show the influence of the distance between bore centers on the resulting moment and force for the out-of-phase in-line engine. The first order moments in a twin-cylinder engine are directly proportional (linear) to the distance between bore centers (see equations (16) and (17)).

Distance between bore centers (m)	0,0704	0,0792	0,0880	0,0968	0,1056
Variation of the distance (%)	-20,0	-10,0	0,0	10,0	20,0
Resulting force (N)	5794	5794	5794	5794	5794
Variation of resulting force (%)	0,0	0,0	0,0	0,0	0,0
Resulting moment (Nm)	581	654	726	799	871
Variation of resulting moment (%)	-20,0	-10,0	0,0	10,0	20,0

**Table 53: Effect of the distance between bore centers on the forces and moments for the longer stroke out-of-phase in-line engine rotating at 4000 rpm**



**Figure 93: Effect of the distance between bore centers on the forces and moments for the longer stroke out-of-phase in-line engine rotating at 4000 rpm**

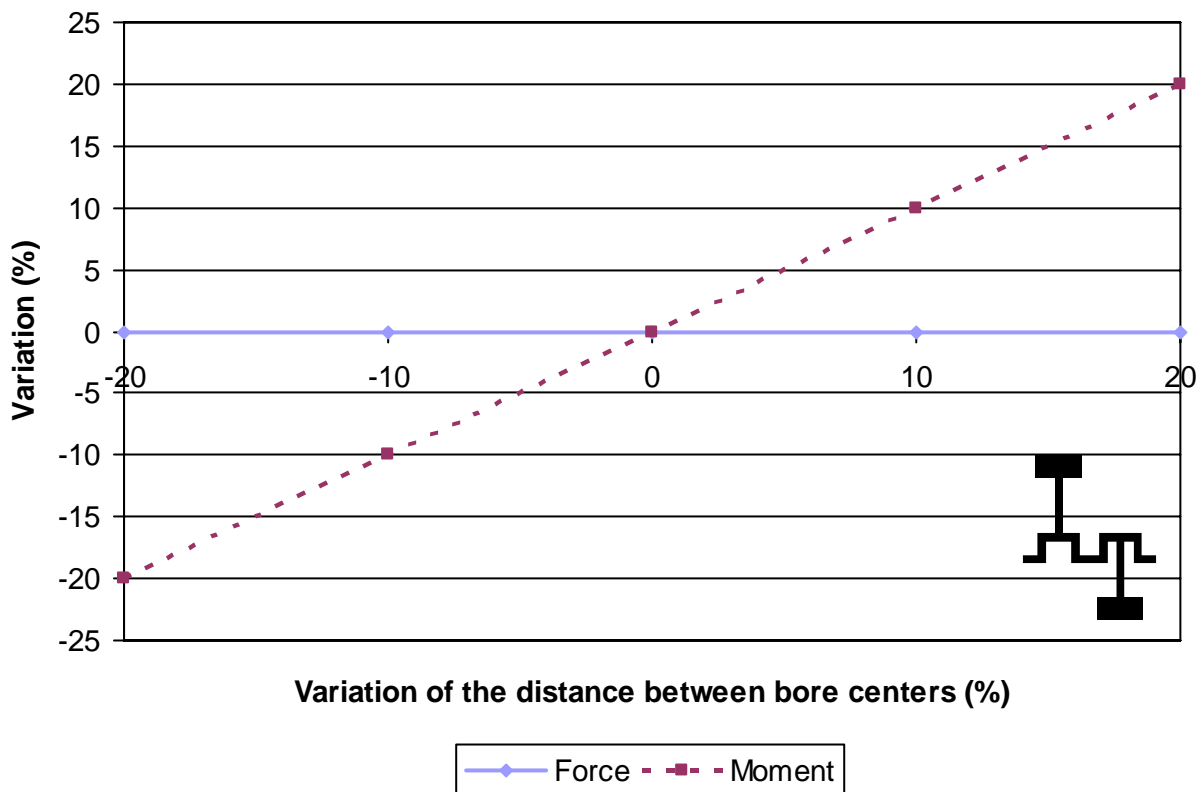


### 7.4.3. Out-of-phase twin-cylinder boxer engine

The table 54 and figure 94 show the influence of the distance between bore centers on the resulting moment and force for the out-of-phase boxer engine. The second order moments in a twin-cylinder engine are directly proportional to the distance between bore centers.

Distance between bore centers (m)	0,0704	0,0792	0,0880	0,0968	0,1056
Variation of the distance (%)	-20,0	-10,0	0,0	10,0	20,0
Resulting force (N)	16504	16504	16504	16504	16504
Variation of resulting force (%)	0,0	0,0	0,0	0,0	0,0
Resulting moment (Nm)	204	229	255	280	306
Variation of resulting moment (%)	-20,0	-10,0	0,0	10,0	20,0

**Table 54: Effect of the distance between bore centers on the forces and moments for the longer stroke out-of-phase boxer engine rotating at 4000 rpm**



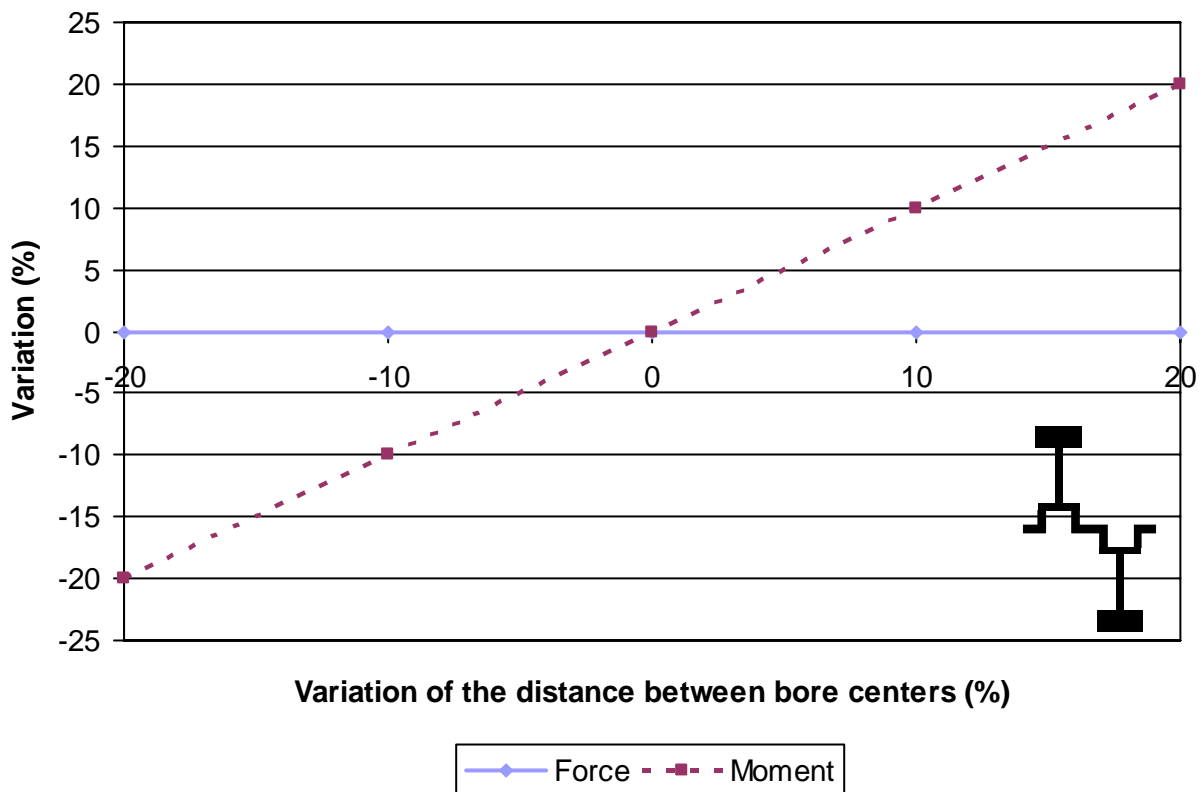
**Figure 94: Effect of the distance between bore centers on the forces and moments for the longer stroke out-of-phase boxer engine rotating at 4000 rpm**

### 7.4.4. In-phase twin-cylinder boxer engine

The table 55 and figure 95 show the influence of the distance between bore centers on the resulting moment and force for the in-phase boxer engine. The moments in a twin-cylinder engine are directly proportional to the distance between bore centers.

Distance between bore centers (m)	0,0704	0,0792	0,0880	0,0968	0,1056
Variation of the distance (%)	-20,0	-10,0	0,0	10,0	20,0
Resulting force (N)	0	0	0	0	0
Variation of resulting force (%)	0,0	0,0	0,0	0,0	0,0
Resulting moment (Nm)	773	870	967	1063	1160
Variation of resulting moment (%)	-20,0	-10,0	0,0	10,0	20,0

**Table 55: Effect of the distance between bore centers on the forces and moments for the longer stroke in-phase boxer engine rotating at 4000 rpm**



**Figure 95: Effect of the distance between bore centers on the forces and moments for the longer stroke in-phase boxer engine rotating at 4000 rpm**

## 7.5. Conclusions

All the parameters we have studied in this section have an impact on the characteristics of the engine, but their effect can be completely different. So we describe here the variation of parameters that can lead to an improvement of the dynamic characteristics (decrease of the resulting forces or moments).

A reduction of the oscillating parts mass leads to a decrease of resulting forces and moments. The relative mass of the connecting rod in the total oscillating mass is smaller than the relative mass of the piston, because the rod has also a rotating motion. So the reduction of mass for the piston is more interesting.

Increasing the length of the connecting rod is a good method to reduce the second and higher order forces and moments but there are some limitations (weight of the connecting rod, buckling hazards, engine height).

A reduction of the distance between bore centers leads to a reduction of the resulting moments. It is a really good solution for boxer engine because the distance between the bore centers is not limited by the bore diameter. So it enables a significant reduction of the moments.

## 8. Conclusions

In this report, we study the inertia forces and the balancing of four different configurations of twin-cylinder engine (in-phase in-line engine, out-of-phase in-line engine, in-phase boxer engine and out-of-phase boxer engine) and two different lengths of stroke. We also study the effect of the gas pressure on engine supporting efforts.

Each one of the four different configurations is subject to two types of loads. The in-phase in-line engine produces first and second order forces (second and higher order, but the higher order are nearly negligible). The out-of-phase in-line engine produces second order forces and first order moments. The in-phase boxer engine generates first and second order moments. And the out-of-phase engine produces first order forces and second order moments. The aspect of the loadings is the same for the two different strokes but the values are higher for the longer stroke.

For all these engines, we try different combinations of balance shafts and crankshaft in order to minimise the forces and moments. Configurations with three or four balance shafts can completely cancel the forces and moments at the price of a high complexity.

So to have an idea of an acceptable level of free forces, we compare the different arrangements with a four-cylinder in-line engine of equivalent power.

The most interesting configuration of engine is the in-phase boxer engine because it does not need to be equipped with balance shafts to reach a low level of vibrations. Some modification of the crankshaft counterweights and a reduction of the distance between bore centers, which is also an advantage for the size of the engine, is favourable and enough to have a well-balanced engine. The most interesting solutions for the other configurations of engine are:

- The out-of-phase in-line engine with a modified crankshaft and one first order double balance shaft,
- The out-of-phase boxer engine with two first order balance shafts and reduced distance between bore centers
- The in-phase in-line engine with two first order balance shafts.

The gas pressure in one cylinder produces a force on the piston that does not need to be balanced. The reason is that the force is transmitted to the engine block through the crankshaft and the gas pressure creates an exact opposite force on the cylinder head that is also transmitted to the engine block. These two forces counteract each other.

For one given pressure inside the cylinder, a longer stroke produces a larger torque. The instantaneous torque produced by the engine is the sum of the torque due to the gas pressure and the torque due to the inertia forces. But the average torque depends only from the gas pressure because the average torque due to the inertia forces is null. So the torque of the engine does not depend on the configuration. But the variation of torque depends on the configuration and thus the size of the flywheel is a function of the arrangement of the engine (in-phase or out-of-phase).

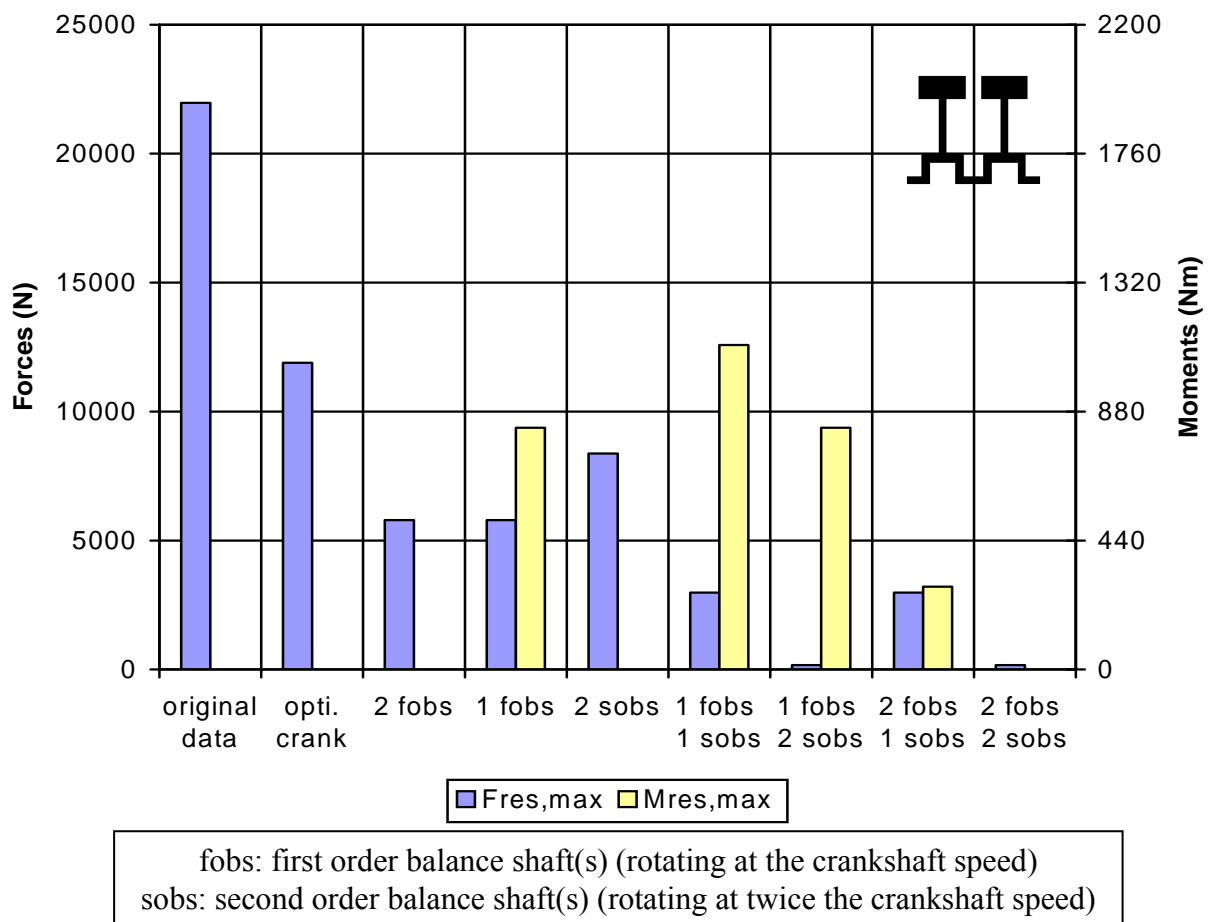
The out-of-phase engines have irregular combustion so they can sound strange. Moreover the variation of torque has to be averaged on two rotations of the crankshaft instead of one, which implies that they need bigger flywheels.

The influence of the variation of different parameters on the forces and moments inside the engine has also been studied. Thereby, the reduction of weight of the connecting rod and the piston, or the increase of length of the connecting rod leads to a decrease of the forces or moments. And for the boxer engine, a reduction of the distance between bore centers allows a decrease of the moments.

The next sections give a short summary of the main properties of the different configurations of twin-cylinder engine.

### In-phase in-line twin-cylinder engine

The in-phase in-line engine is the most classical configuration of twin-cylinder engine. It is subject to *first and second order forces* but it is not subject to moments, at least in its basic configuration.

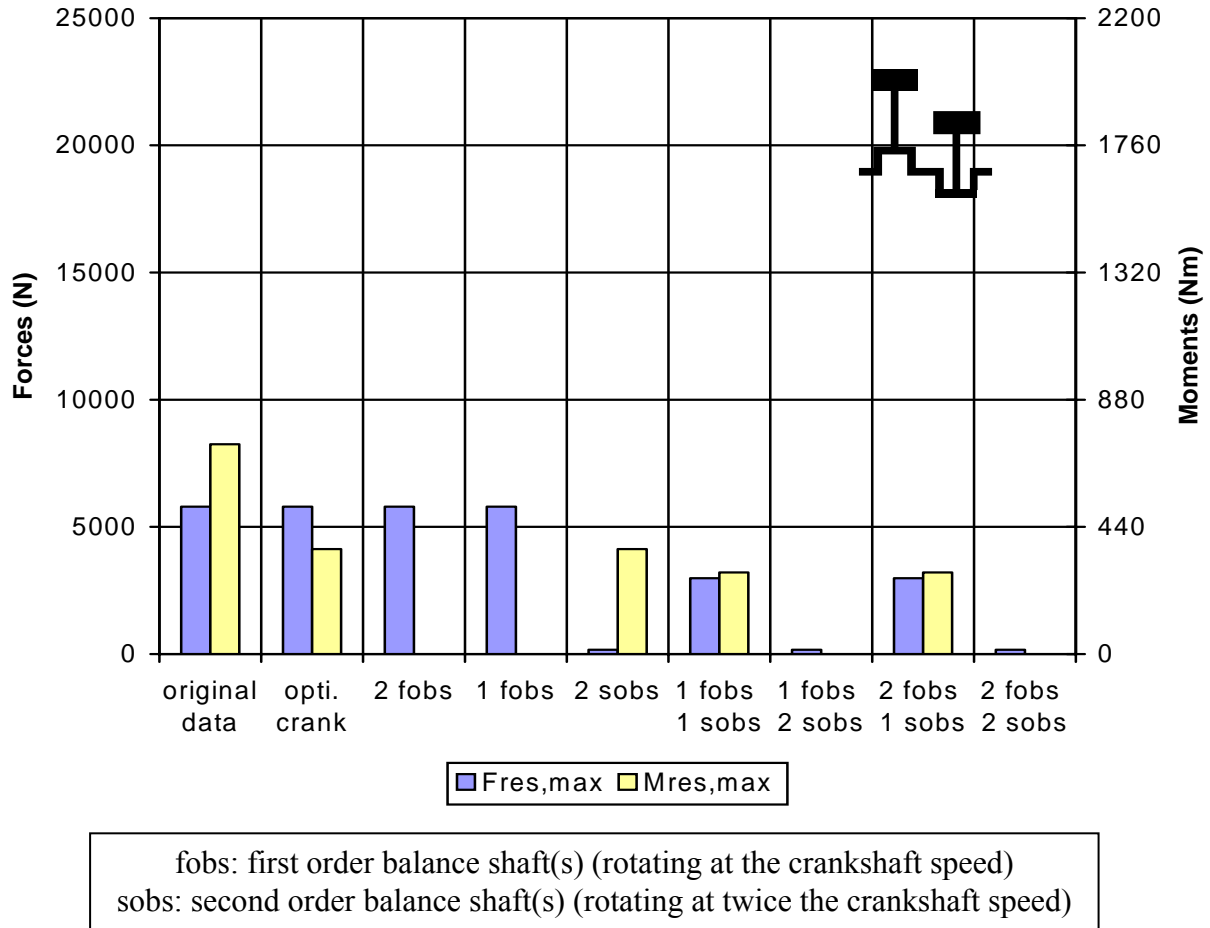


**Figure 96: Maximum values of resulting forces for different balancing systems of the longer stroke in-phase in-line twin-cylinder engine rotating at 4000 rpm**

The simplest configuration of in-phase in-line engine that has a small enough level of loadings (smaller or equal to the reference level) is the one with *two first order balance shafts* (see figure 96). We notice that due to the first order forces, it is recommended to avoid all the solutions using one single first order balance shaft because the offset between the crankshaft and the balance shaft creates important rolling moments.

## Out-of-phase in-line twin-cylinder engine

The out-of-phase in-line engine is subject to *second order forces* and *first order moments*.

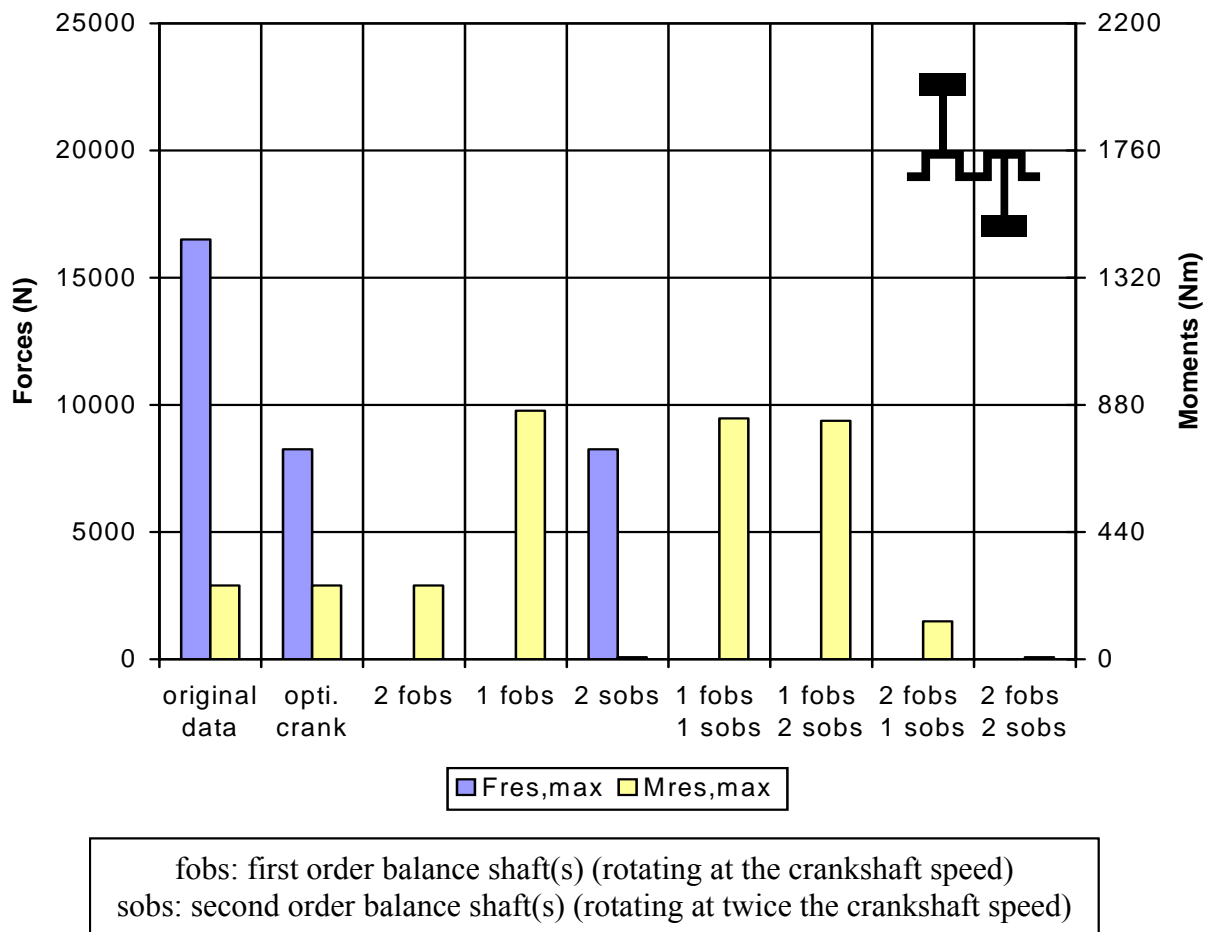


**Figure 97: Maximum values of resulting forces and moments for different balancing systems of the longer stroke out-of-phase in-line twin-cylinder engine rotating at 4000 rpm**

The simplest configuration of out-of-phase in-line engine that has a small level of loadings (smaller or equal to the reference level) is the one with *the modified crankshaft and one first order balance shafts* (see figure 97). In fact, the crankshaft is modified to have the same effect that a second balance shaft. As there are no first order forces, the offset between the crankshaft and the balance shaft does not produce free rolling moments.

## Out-of-phase twin-cylinder boxer engine

The out-of-phase boxer engine is subject to *first order forces* and *second order moments*.

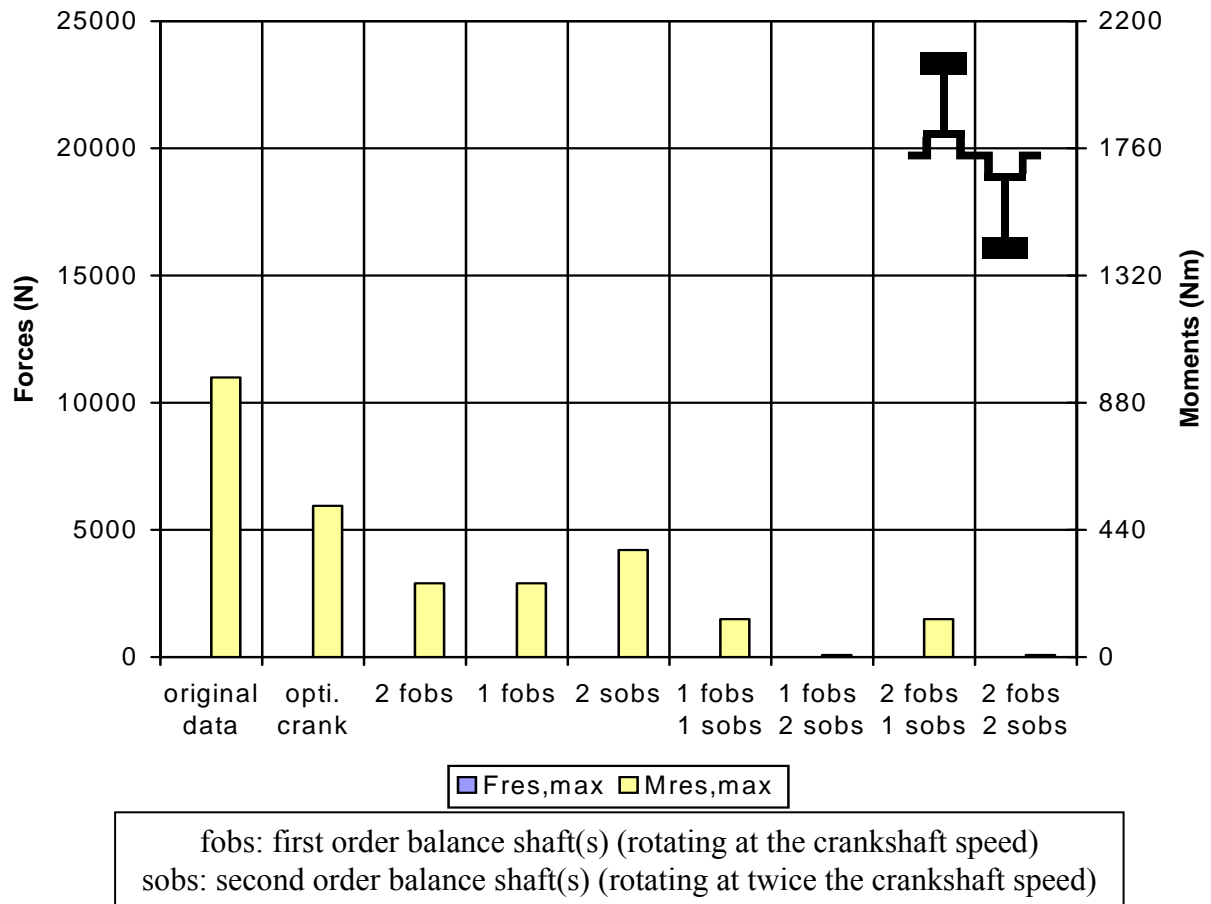


**Figure 98: Maximum values of resulting forces for different balancing systems of the longer stroke out-of-phase twin-cylinder boxer engine at 4000 rpm**

The simplest configuration of out-of-phase boxer engine that has a small enough level of loadings (smaller or equal to the reference level) is the one with *two first order balance shafts* (see figure 98). With this solution, it remains only second order moments. Moreover, these moments can be reduced by bringing the connecting rods close to each others. That is possible for this kind of engine because, as the cylinders are opposed, the distance between the bore centres are not limited by the size of the piston and because the connecting rods can be attached to the same crankpin. So the distance between the connecting rod can be nearly equal to zero and so does the value of the moments. This configuration can cancel nearly all inertia forces and moments and allows having a very compact engine.

## In-phase twin-cylinder boxer engine

The in-phase boxer engine is subject to *first and second order moments* but it is not subject to forces in any configuration.



**Figure 99: Maximum values of resulting forces and moments for different balancing systems of the longer stroke in-phase twin-cylinder boxer engine rotating at 4000 rpm**

The simplest configuration of in-phase boxer engine that has a small enough level of loadings (smaller or equal to the reference level) is the one with *one first order balance shafts* (see figure 99). In this configuration, it remains only the second order moments like in the out-of-phase boxer engine with two first order balance shafts. And in this case, the distance between bore centres can also be reduced. But, there is a limitation due to the fact that the connecting rods are attached on two different crankpins.

If advantages are taken of the reduction of distance between the bore centres, the moments can be small enough to consider a solution without balance shafts. A solution with an *optimized crankshaft* gives already good results. The drawback of this configuration is that the load becomes a mix of rolling and yawing moments instead of rolling moments alone. This may need to modify the support mounts of the engine.



# References

BAYRAKÇEKEN H., TASGETIREN S. & AKSOY F., *Failures of single cylinder diesel engines crank shafts*, Engine Failure Analysis 14 (2007), pp. 725-730

*Automotive handbook, 5th edition*, BOSCH, 2000

BOYSAL A. & RAHNEJAT H., *Torsional vibration analysis of a multi-body single cylinder internal combustion engine model*, Applied Mathematics Modelling 21 (1997), pp.481-493

BRUN R., *Science et technique du moteur diesel industriel et de transport, tome 2, seconde édition*, Technip, 1977

BTD (<http://www.btd.be>), accessed August 2008

CARBIBLES (<http://www.carbibles.com/>), accessed July 2007

CHAUVIN J., CORDE G., MOULIN P., PETI N. & ROUCHON P., *High frequency individual cylinder estimation for control of diesel engines*, Oil & Gas Science and Technology, Vol. 61(2006) pp. 57-72

CHO S.H., AHN S.T. & KIM Y.H., *A simple model to estimate the impact force induced by the piston slap*, Journal of Sound and Vibration (2002) 255(2), pp. 229-242

DAIHATSU (<http://fr.daihatsu.be>), accessed August 2008

FOUMANI M. S., KHAJEPOUR A. & DURALI M., *Optimization of engine mount characteristics using experimental/numerical analysis*, Journal of Vibration and Control 9 (2003), pp.1121-1139

GOLINVAL J.C., JAMOULLE A. & MARIN F., *Two cylinders engine (Technical report)*, Université de Liège, 2000

GOLINVAL J.C., *Dynamique des constructions mécaniques (Cours)*, AEES Université de Liège, 2001

GRIGORYEV E., VASILYEV, A. & DOLGOV K., *The influence of the arrangement scheme on balancing and mass dimension parameters of engines*, ISSN 1392-1207 MECHANIKA 2006 Nr. 5

HEISLER H., *Advanced engine technology*, Butterworth-Heinemann, 1995

HEISLER H., *Vehicle and engine technology, second edition*, Butterworth-Heinemann, 1999

HEYWOOD J.B., *Internal combustion engine fundamentals*, McGraw-Hill, 1988

HYUNDAI (<http://www.hyundai.be>), accessed August 2008

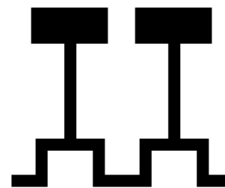
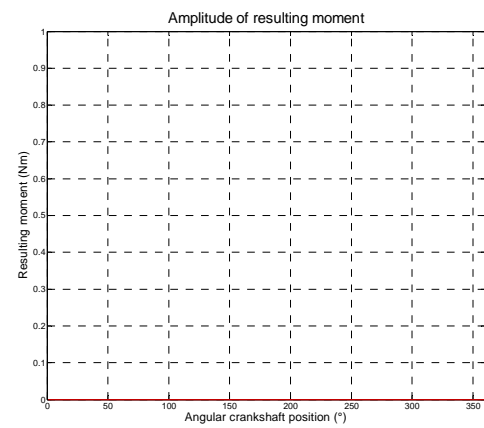
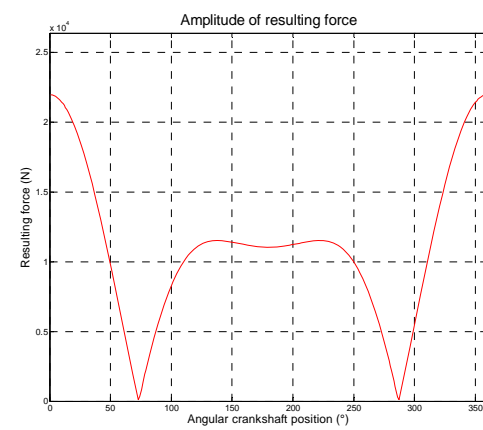
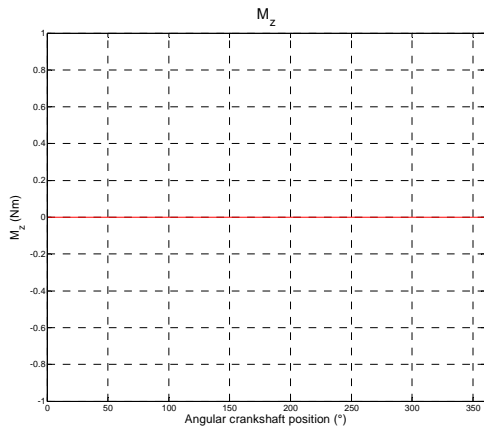
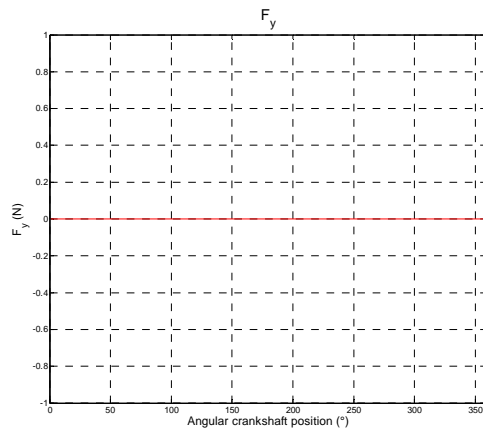
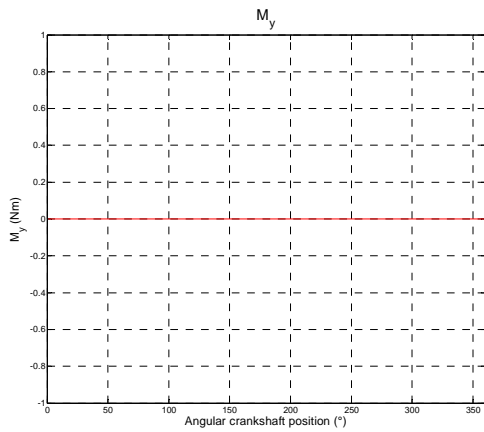
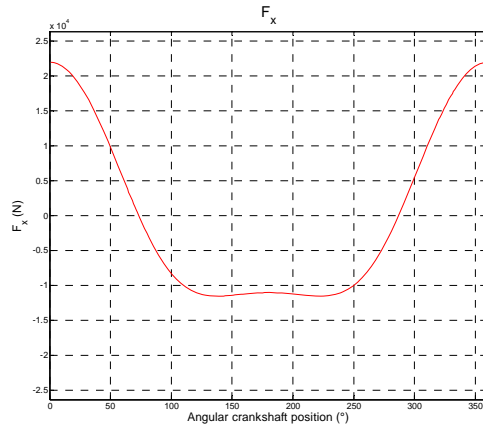
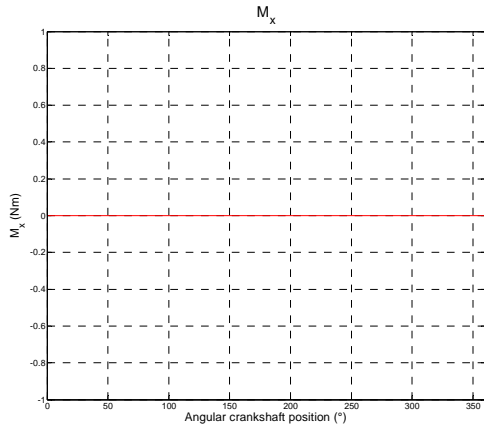
- MAASS H. & KLIER H., *Kräfte, momente und deren ausgleich in der verbrennungskraftmaschine*, Springer-Verlag, 1981
- MEMETEAU H., *Technologie fonctionnelle de l'automobile, tome 1*, Dunod, 1997
- METALLIDIS P. & NATSIAVAS S., *Linear and nonlinear dynamics of reciprocating engines*, International Journal of Non-Linear Mechanics 38(2003), pp. 723-738
- MOURELATOS Z. P., *A crankshaft system model for structural dynamic analysis of internal combustion engines*, Computer and Structures 79 (2001), pp.2009-2027
- OPEL (<http://www.opel.be>), accessed August 2008
- ÖSTMAN F. & TOIVONEN H. T., *Active torsional vibration control of reciprocating engines*, Control Engineering Practice, 16 (2008), pp. 78-88
- PORSCHE (<http://imp.porsche.com/belgium/>), accessed July 2007
- POUILLE J.P., *Moteurs diesel d'automobiles, conception et mise au point*, Techniques de l'ingénieur (<http://www.techniques-ingenieur.fr/>), accessed June 2007
- SMART (<http://www.smart.com/fr>), accessed August 2008
- SNYMAN J. A., HEYNS P. S. & VERMEULEN P. J., *Vibration isolation of a mounted engine through optimization*, Mech. Mach. Theory, Vol. 30 (1995), pp.109-118
- SWOBODA B., *Mécanique des moteurs alternatifs*, Technip, 1984
- TOYOTA (<http://www.toyota.be>), accessed August 2008
- VASILYEV, A. & DOLGOV K., *The arrangement scheme and its influence on vibration process of the vehicle piston engine*, ISSN 1392-1207 MECHANIKA 2007 Nr. 4
- VANOVERSCHELDE N., *Etude de la dynamique d'un groupe motopropulseur deux cylindres à plat (Master thesis)*, Université de Liège, 2008
- VW (<http://be.volkswagen.com>), accessed August 2008
- WIKIPEDIA (<http://wikipedia.org/>), accessed July 2007
- ZOUROUFI M. & FATEMI A., *A literature review on durability evaluation of crankshafts including comparisons of competing manufacturing processes and cost analysis*, 26<sup>th</sup> Forging Industry Technical conference, Chicago IL, November 2005

# Appendix

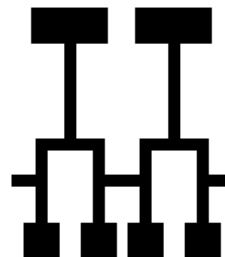
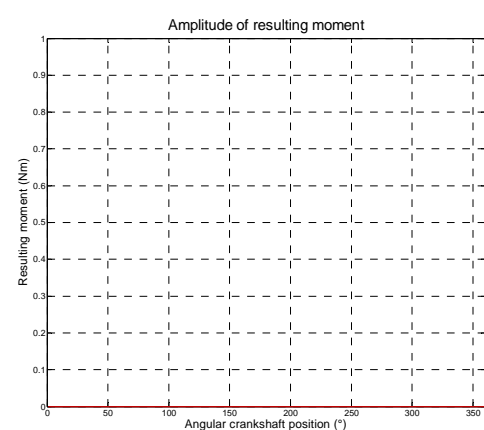
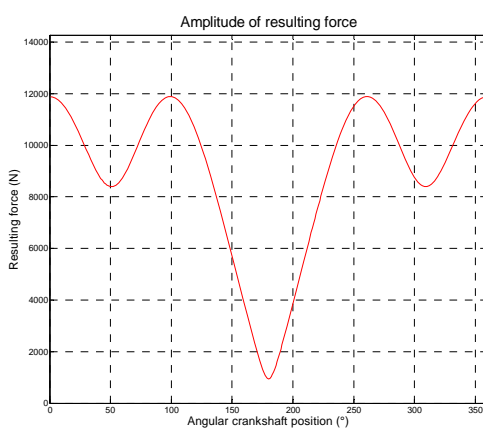
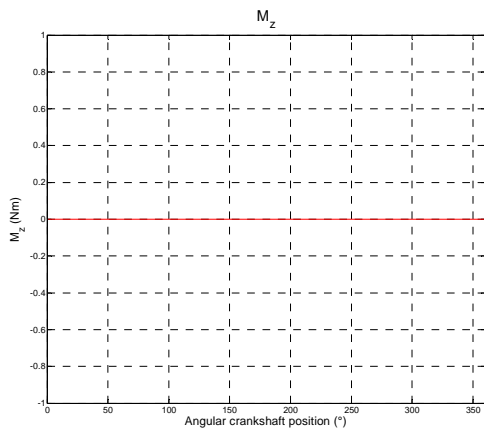
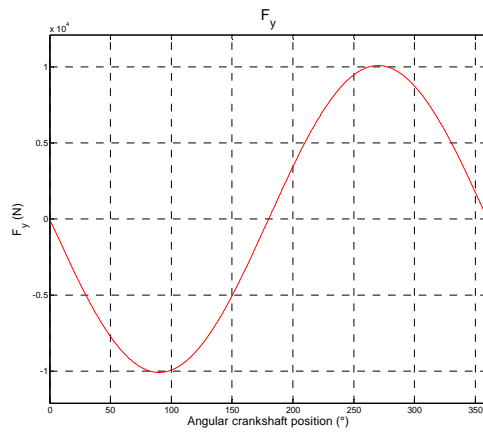
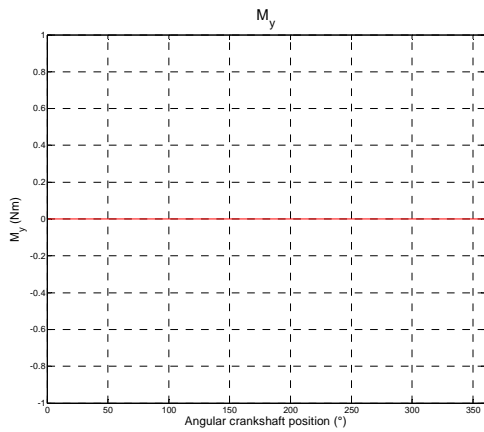
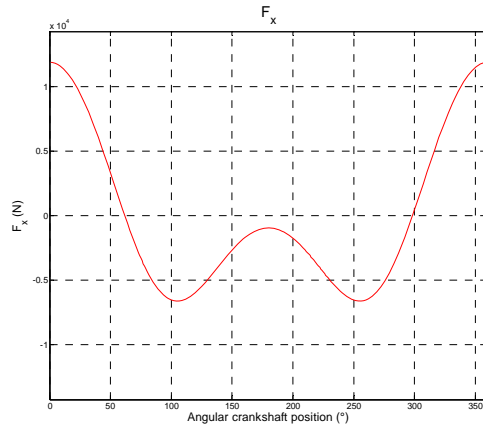
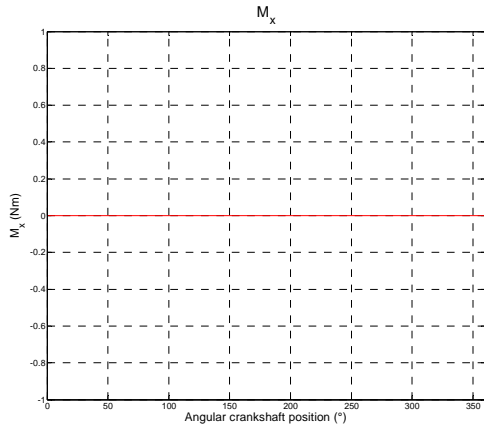
## Appendix A: Graphics of forces and moments for the different configurations of twin-cylinder engine

The first appendix gives the graphics representing the different forces and moments for all the configurations of *longer* stroke engine. The aspect of the curves of forces and moments are the same for the longer and shorter stroke engines. Only the values are slightly different, they are more or less thirteen percent more important for the longer stroke engines. So we choose to give only the graphics of the longer stroke engine, the shorter strokes curves can be extrapolated on the bases of the longer stroke graphics and on the maximum values given in the table 16, 21, 23 and 25.

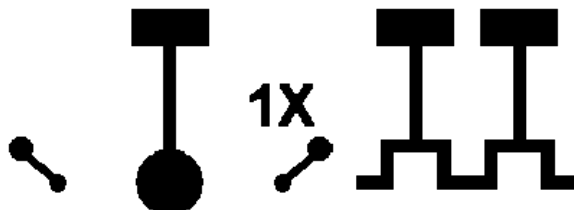
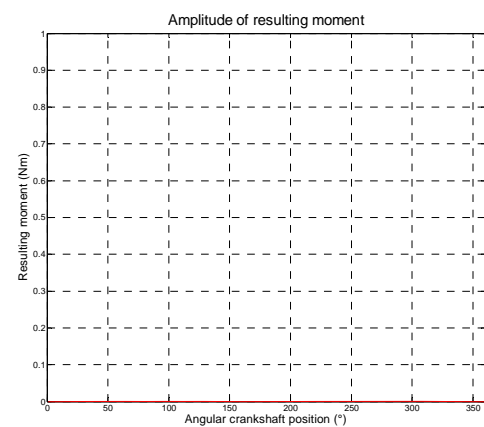
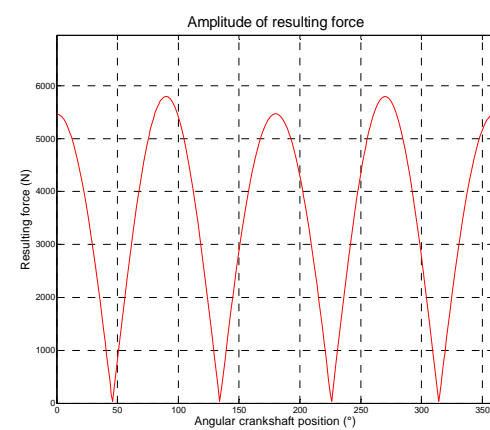
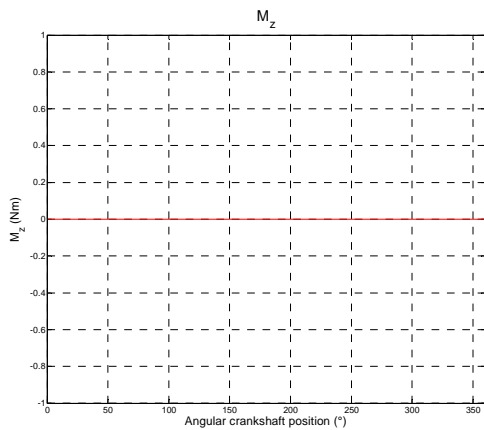
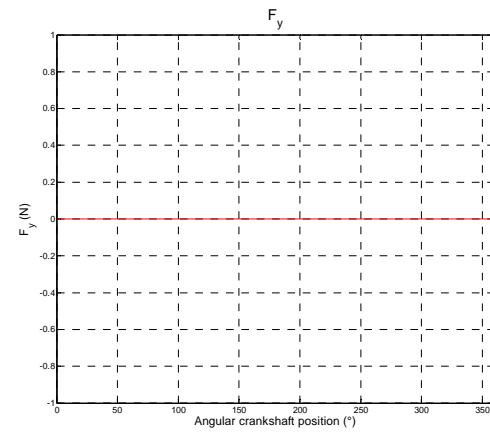
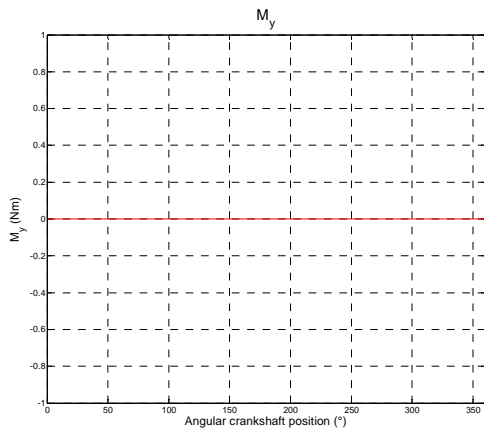
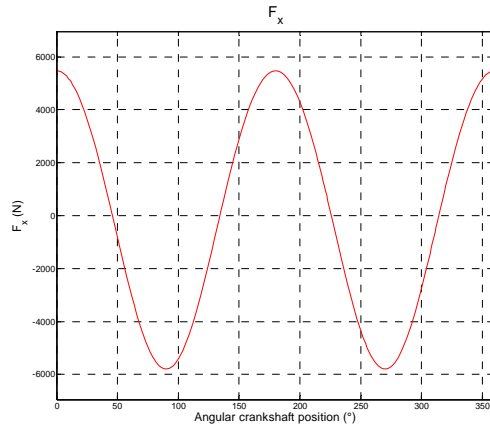
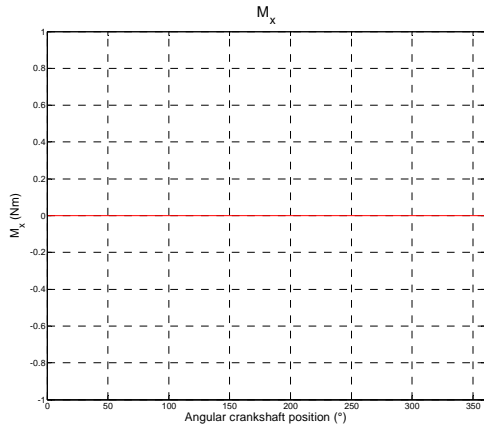
# In-phase in-line engine



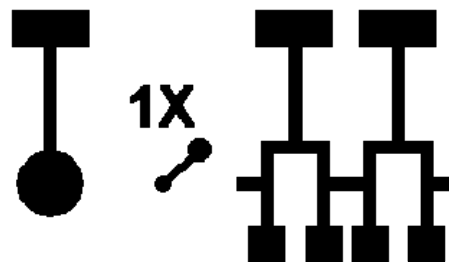
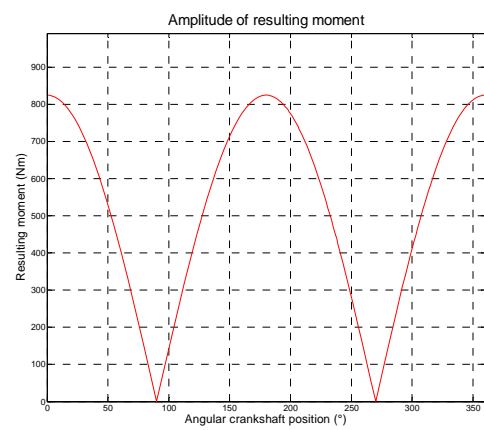
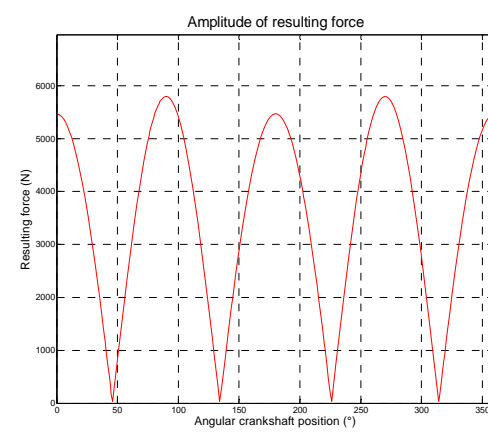
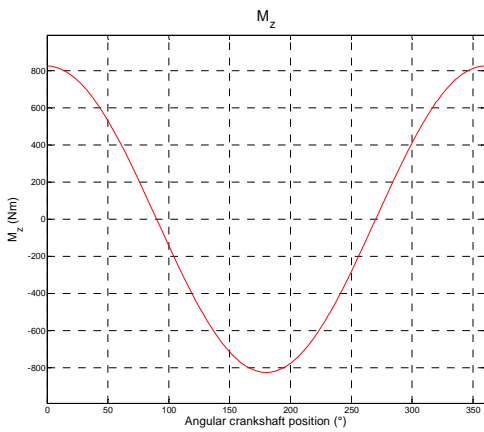
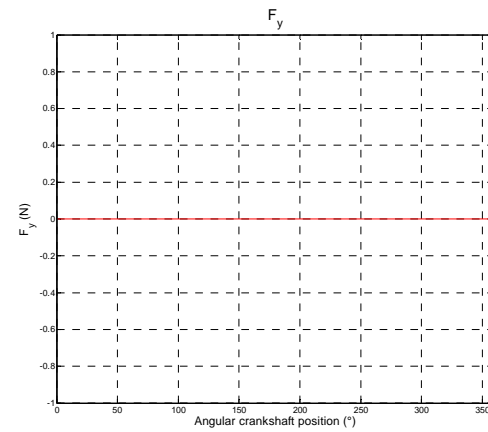
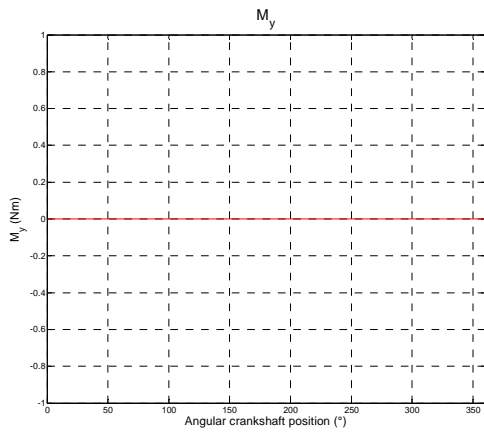
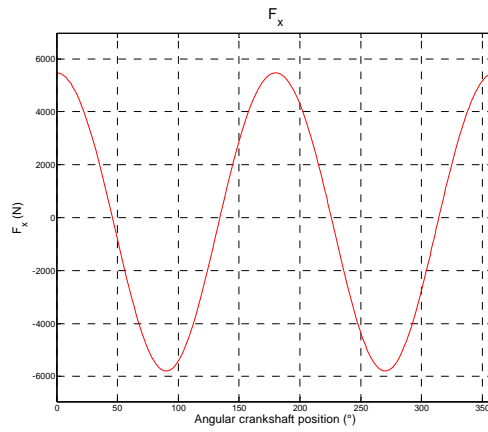
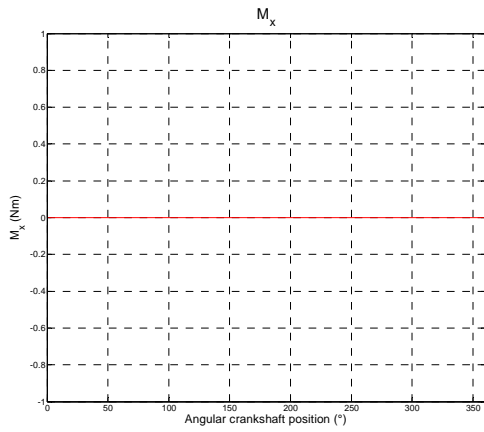
# In-phase in-line engine with optimized crankshaft



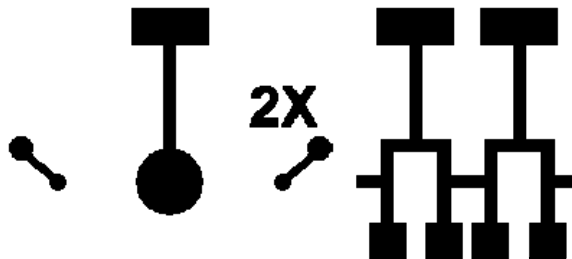
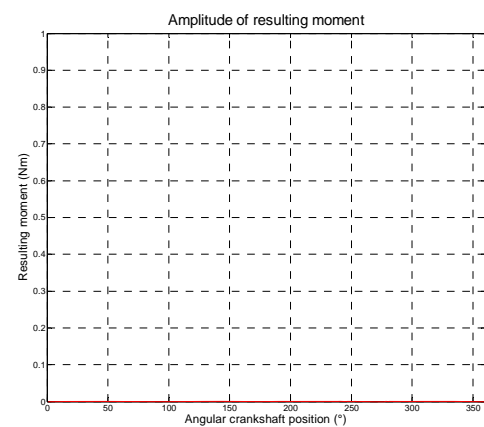
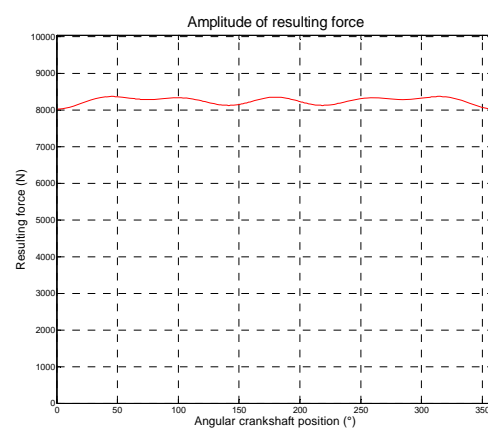
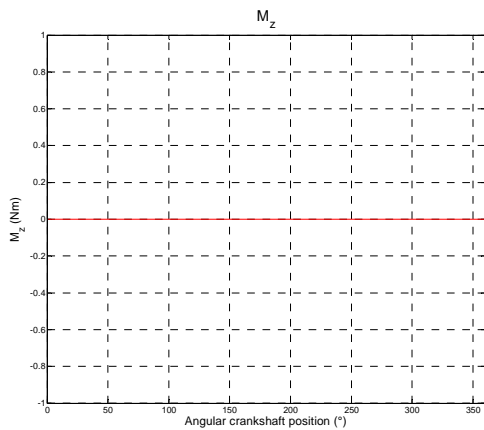
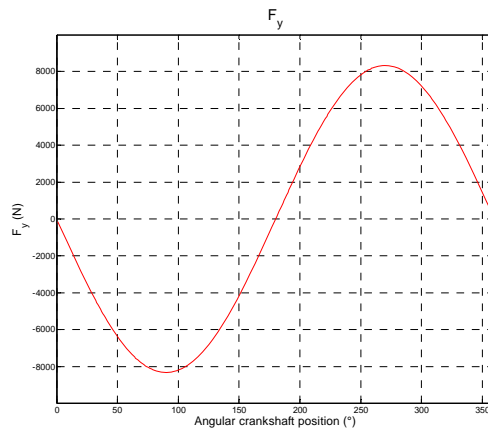
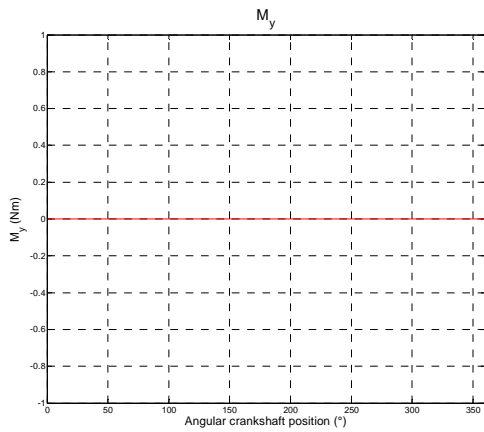
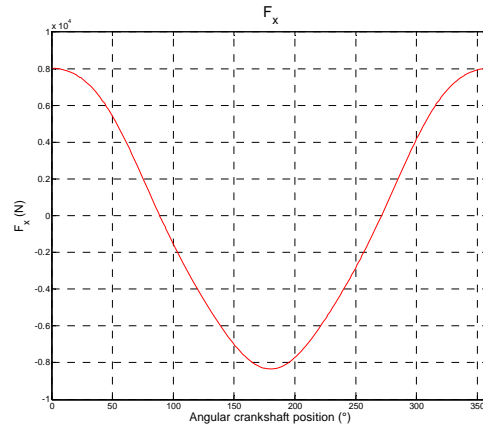
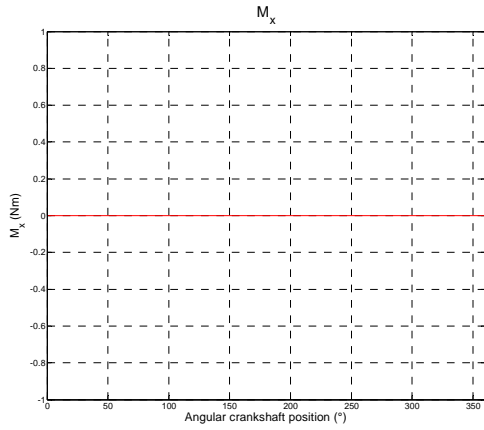
## In-phase in-line engine with two first order balance shafts



## In-phase in-line engine with one first order balance shaft and optimized crankshaft

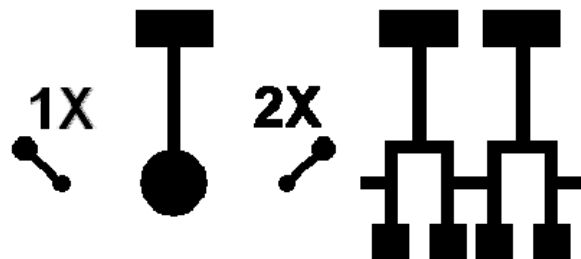
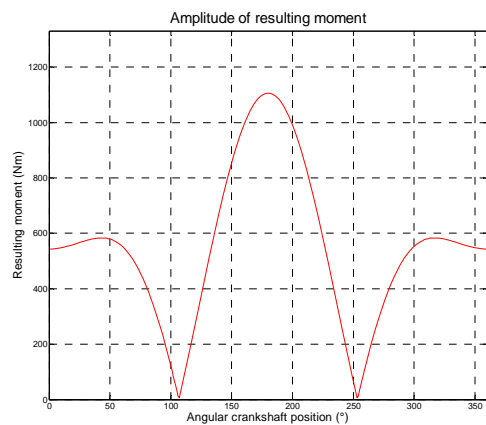
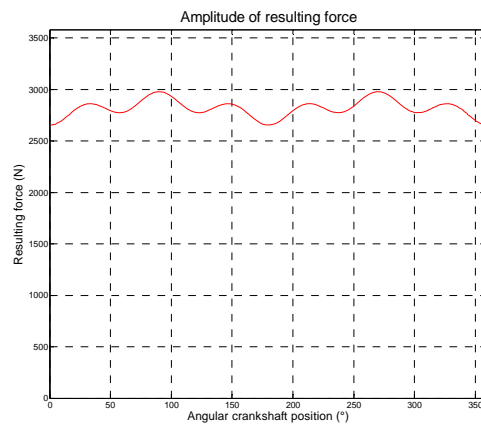
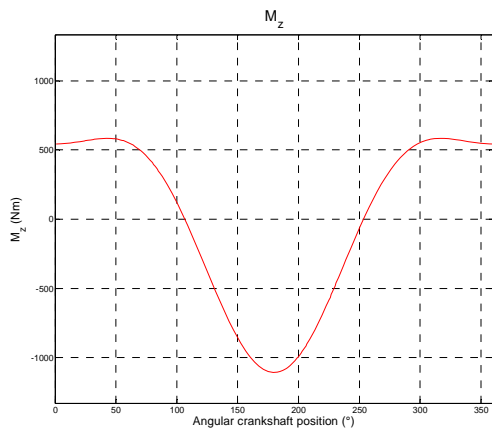
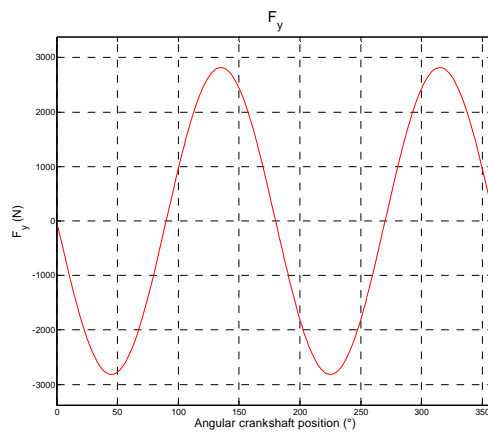
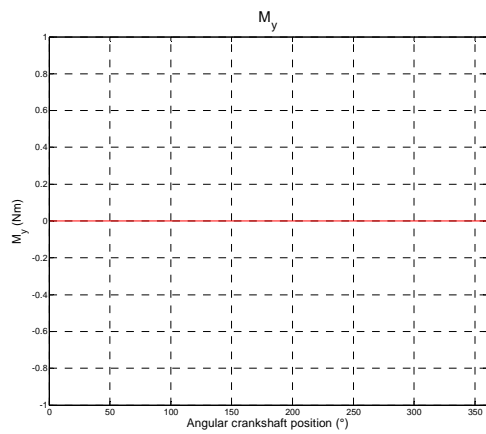
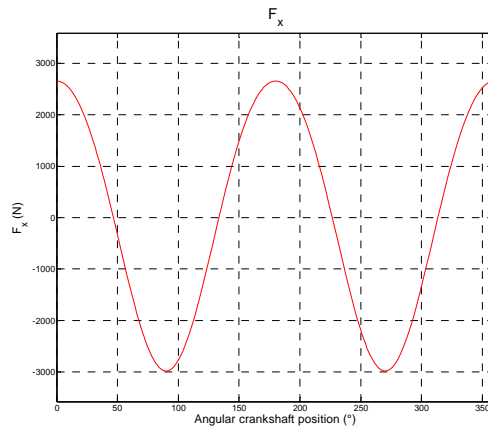
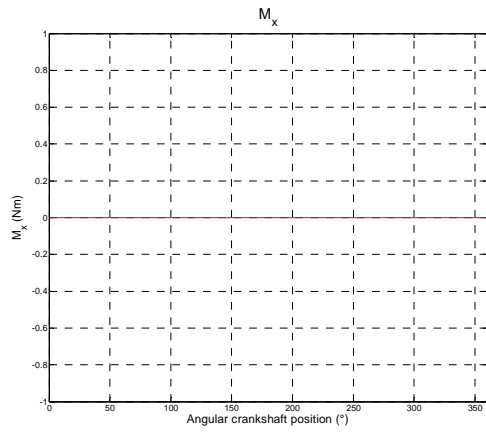


# In-phase in-line engine with two second order balance shaft and optimized crankshaft

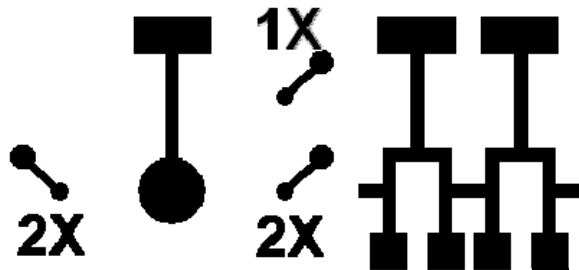
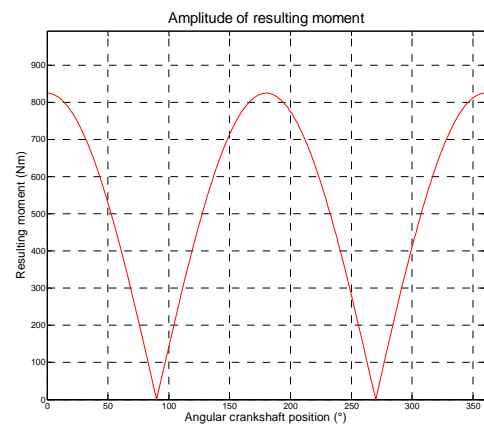
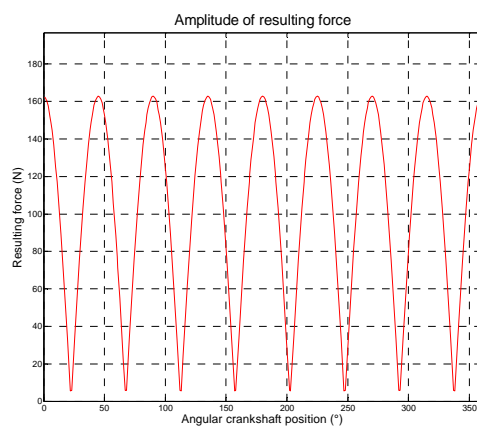
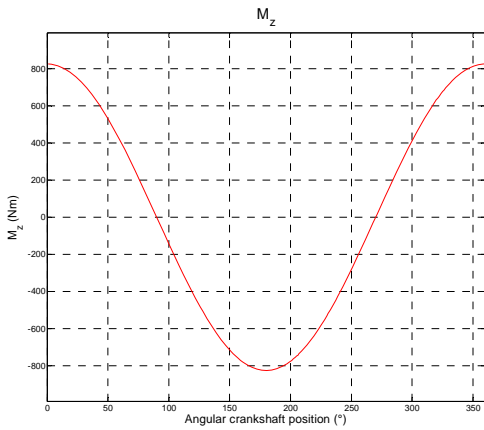
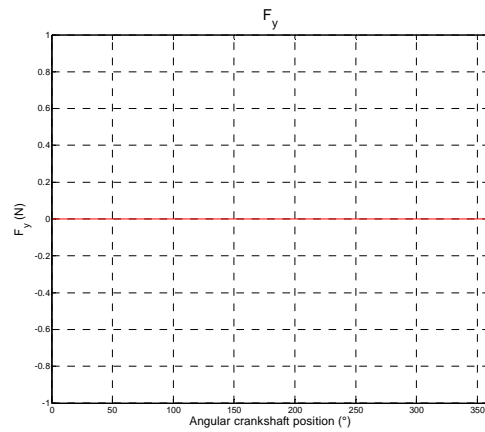
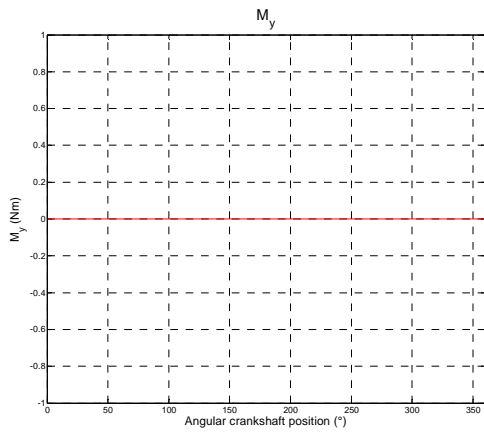
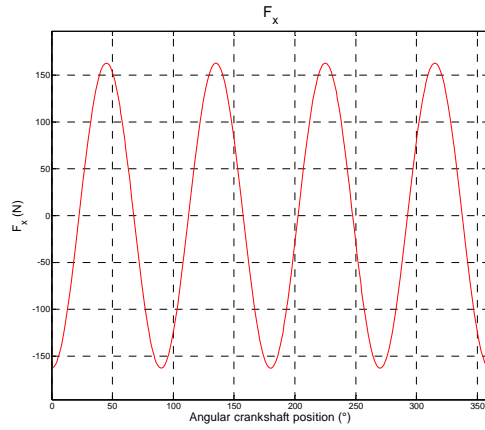
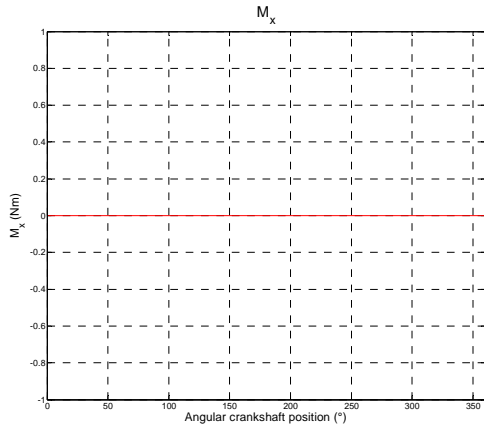




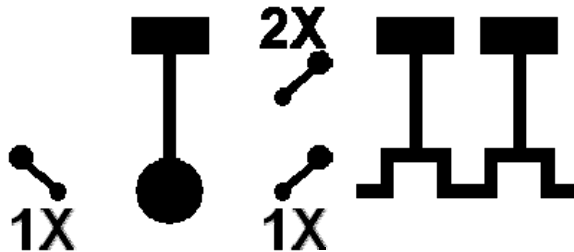
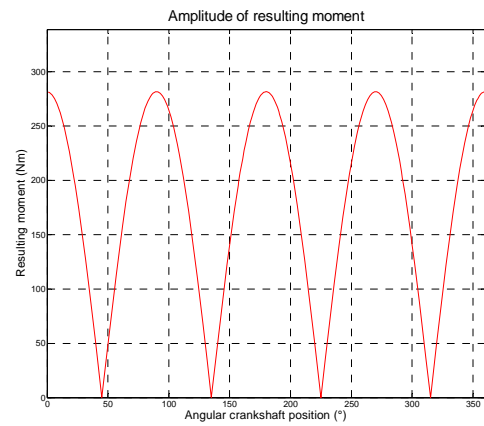
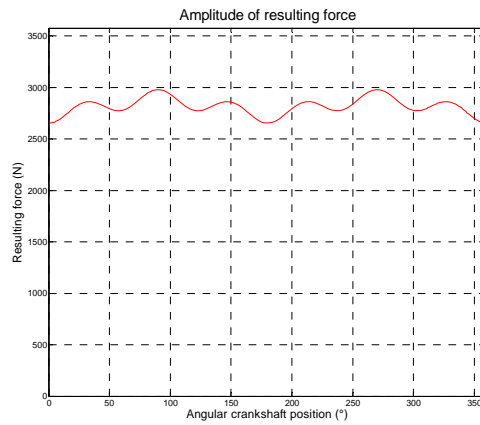
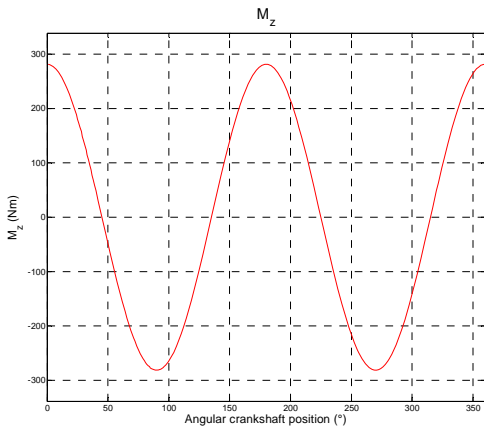
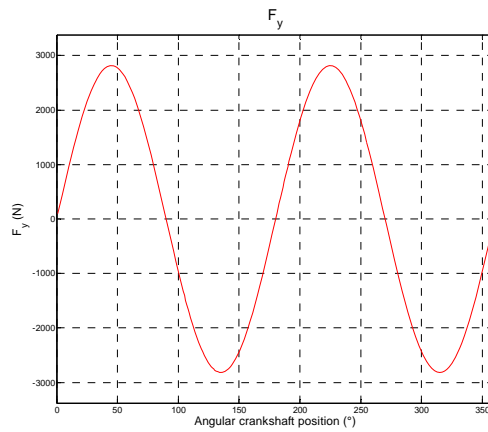
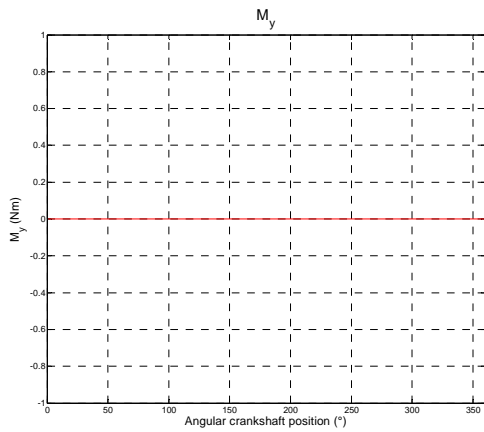
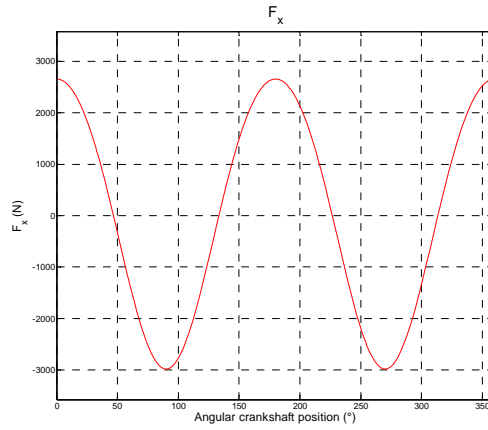
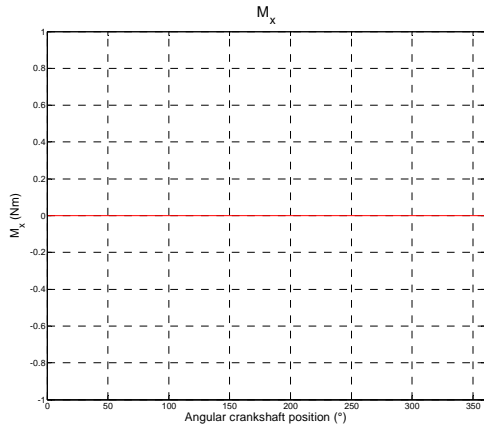
## In-phase in-line engine with one first and one second order balance shafts



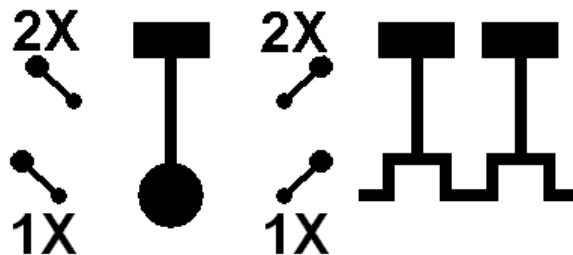
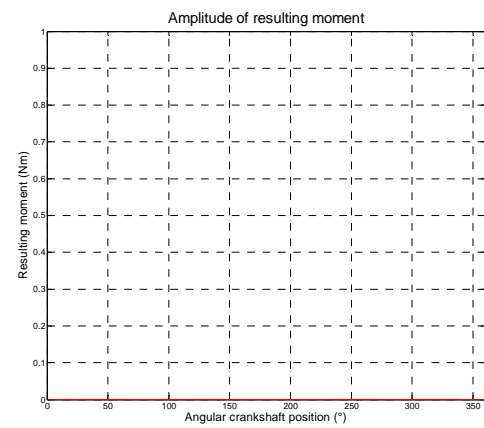
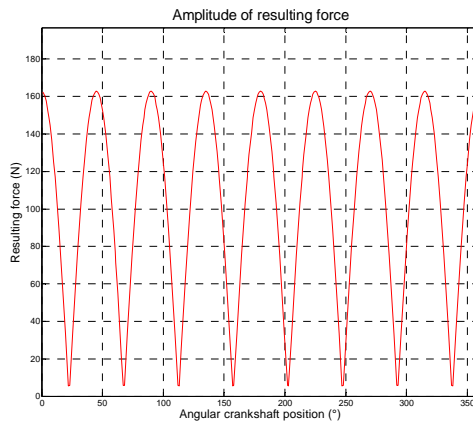
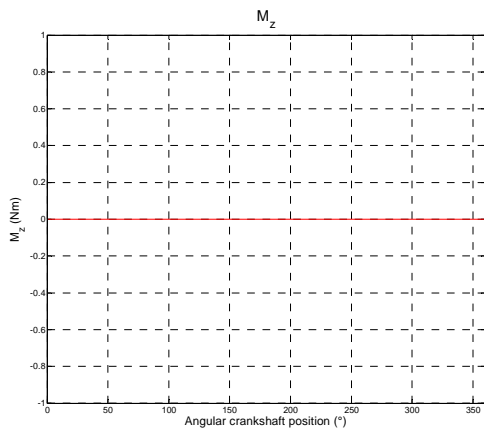
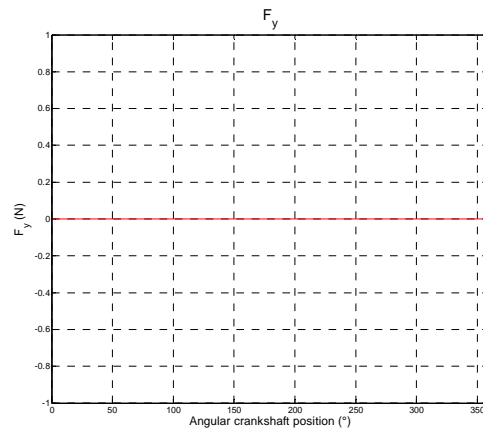
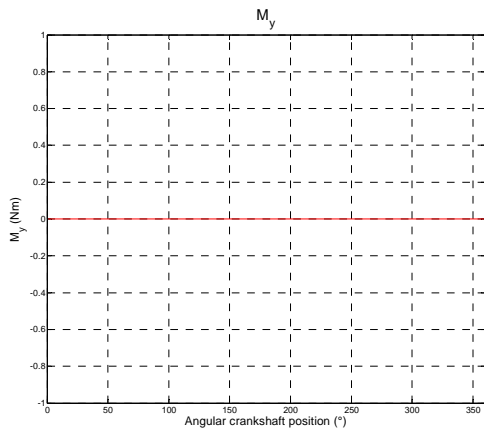
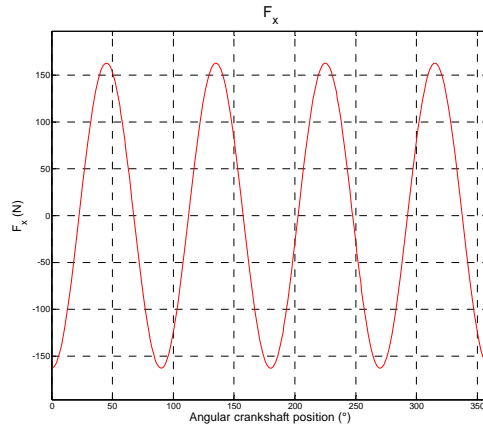
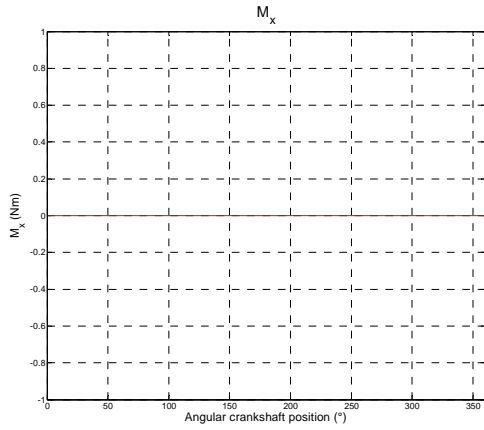
## In-phase in-line engine with one first and two second order balance shafts



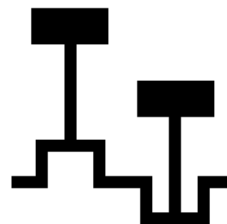
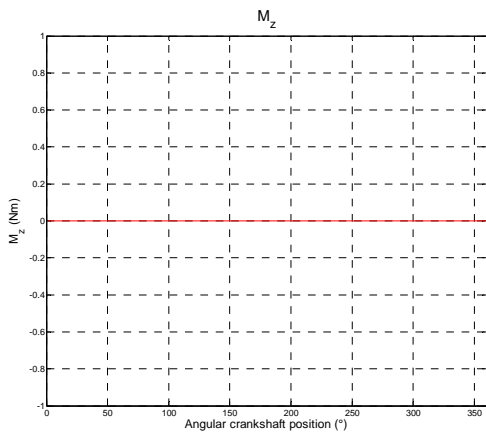
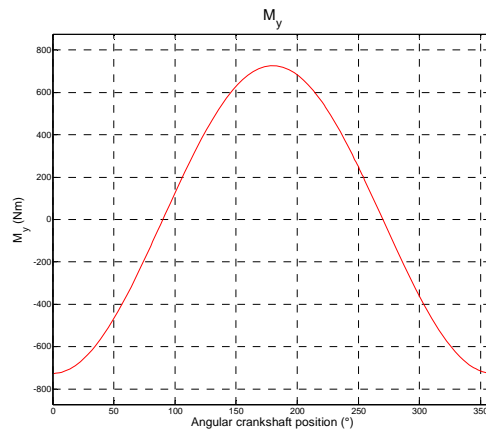
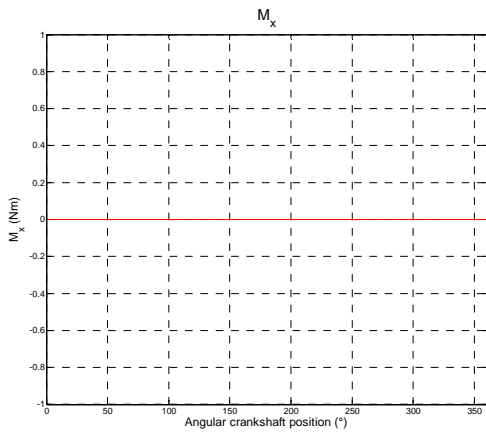
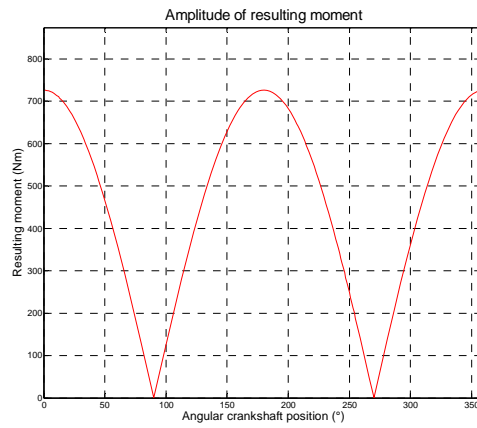
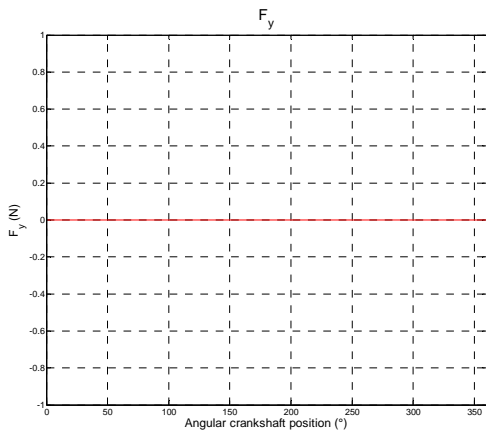
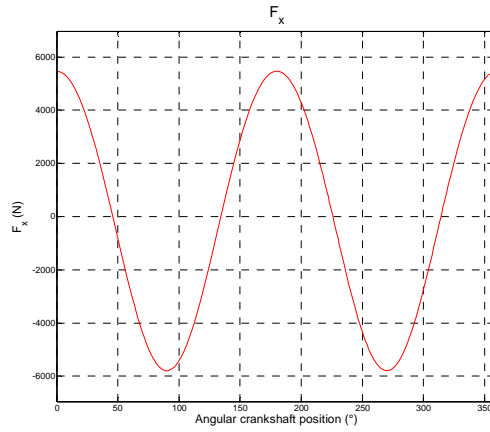
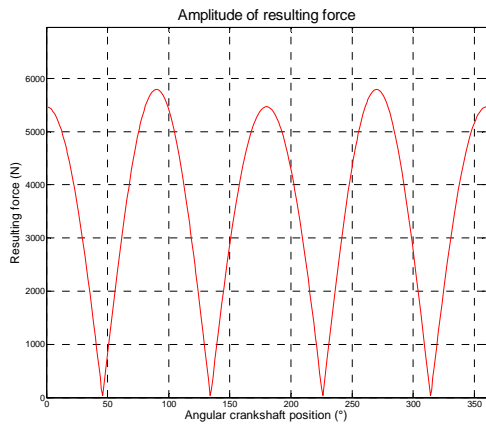
## In-phase in-line engine with two first and one second order balance shafts



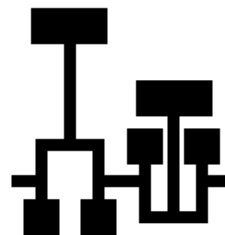
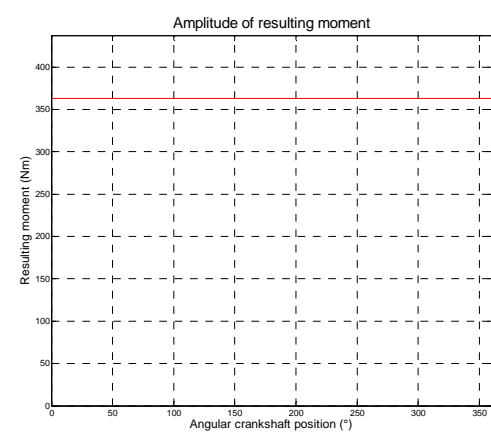
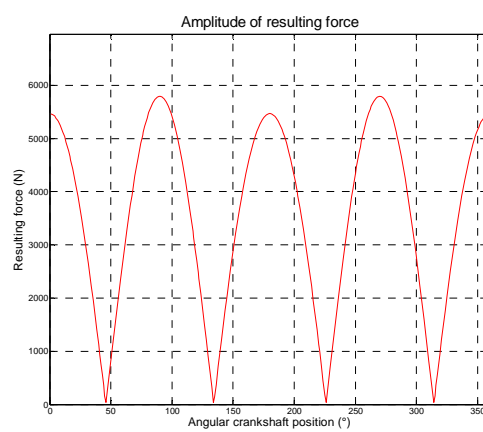
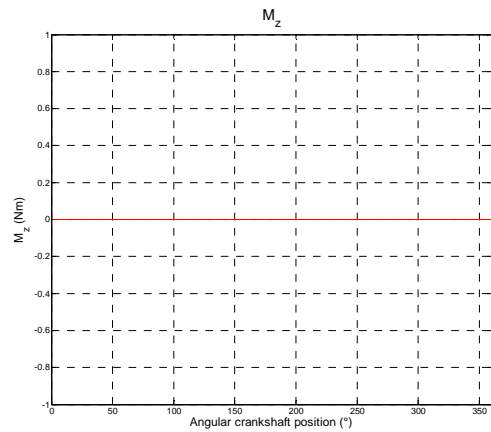
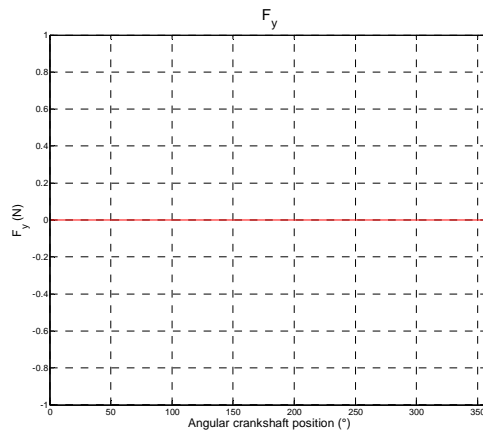
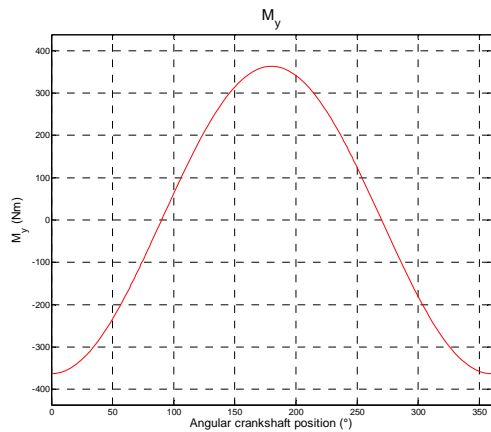
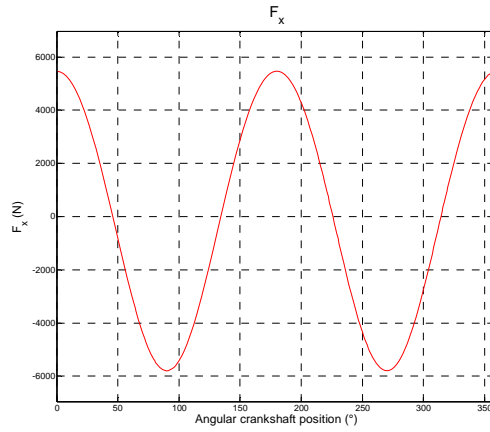
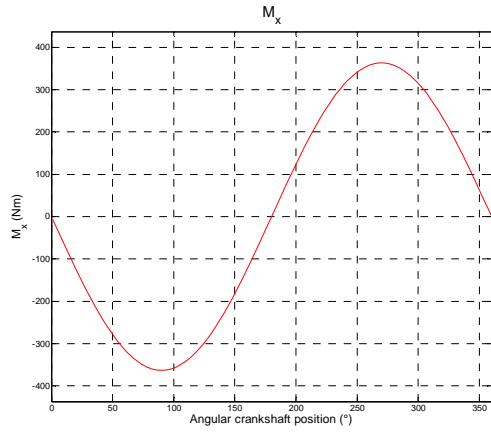
## In-phase in-line engine with two first and two second order balance shafts



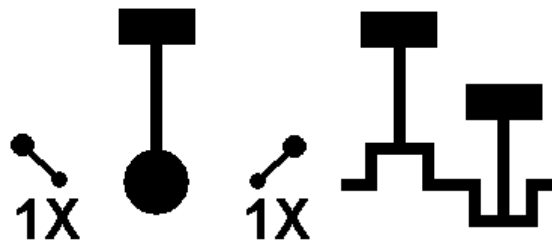
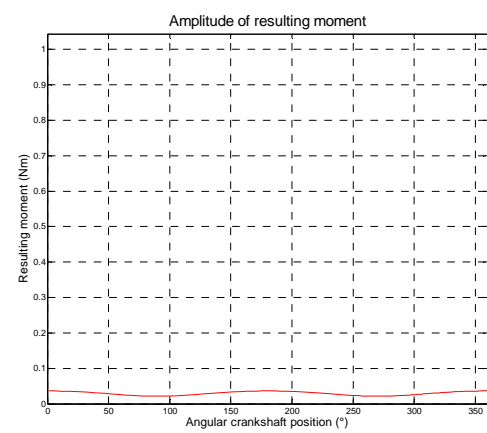
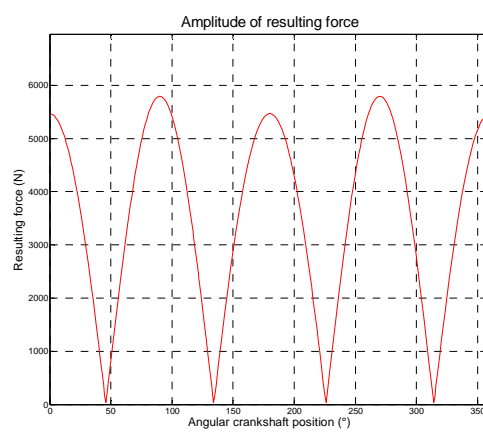
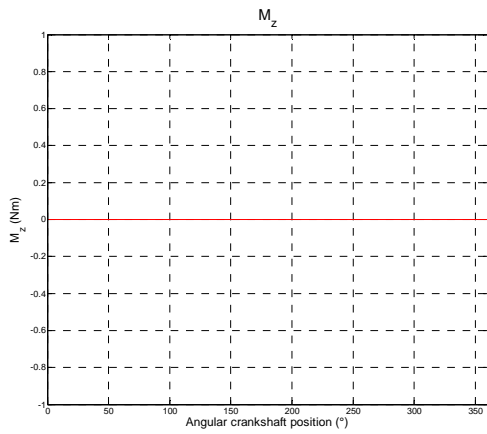
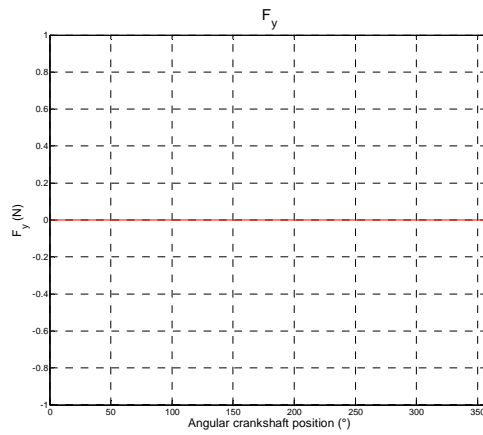
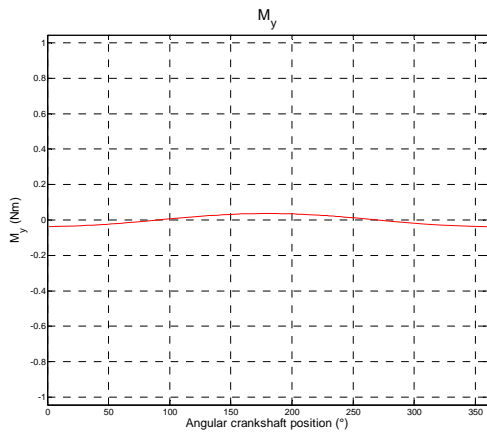
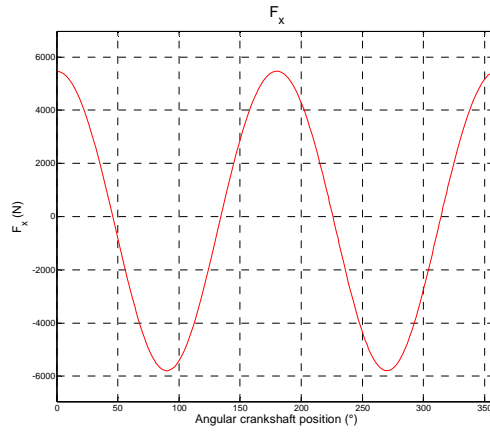
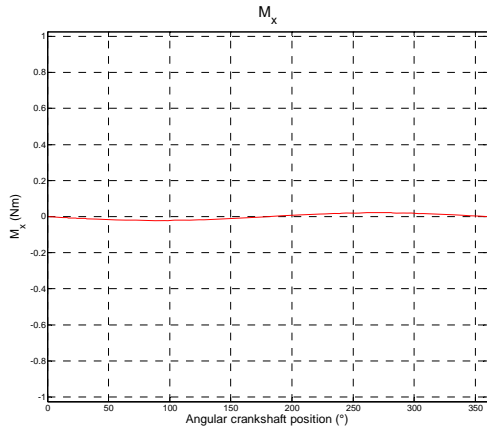
# Out-of-phase in-line engine



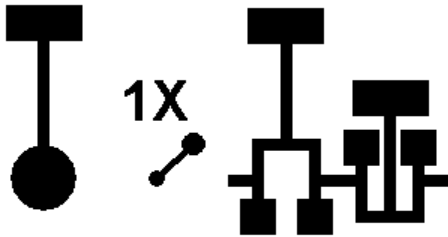
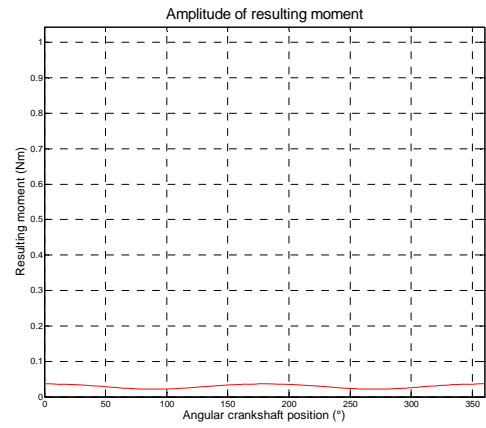
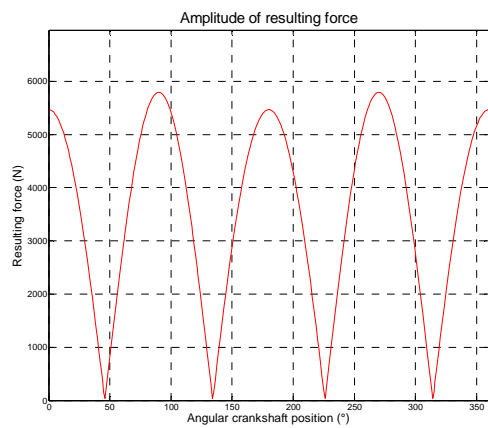
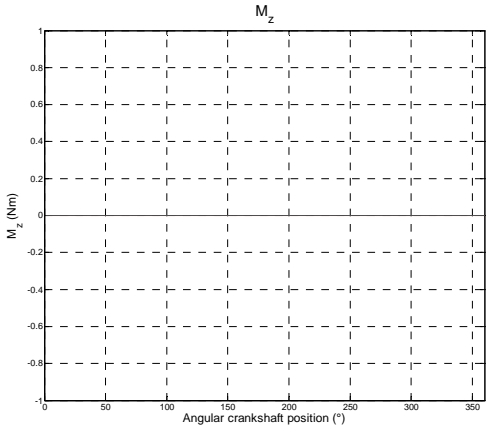
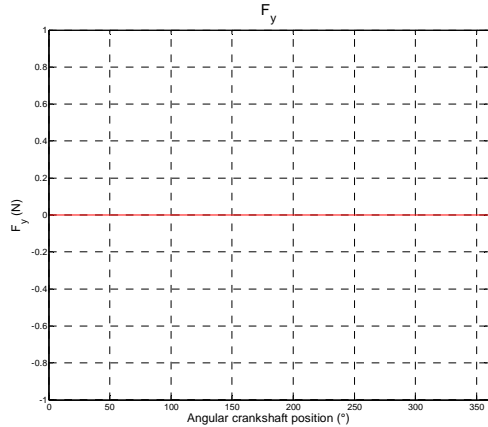
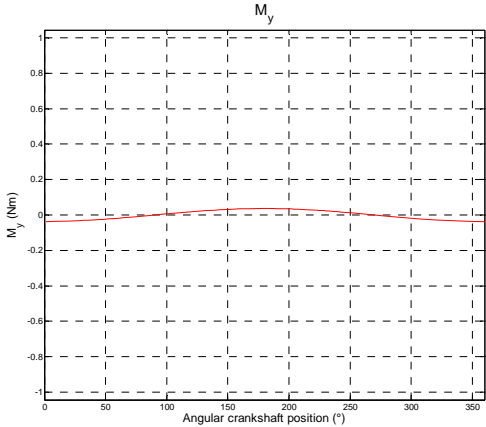
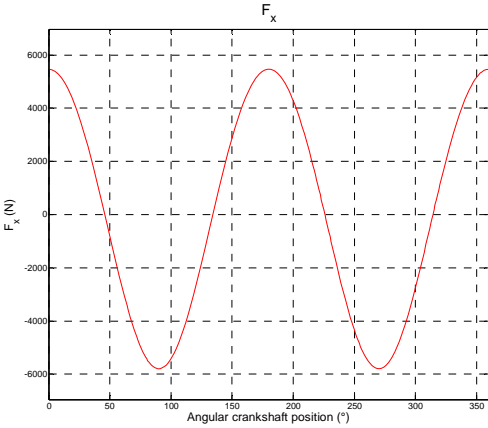
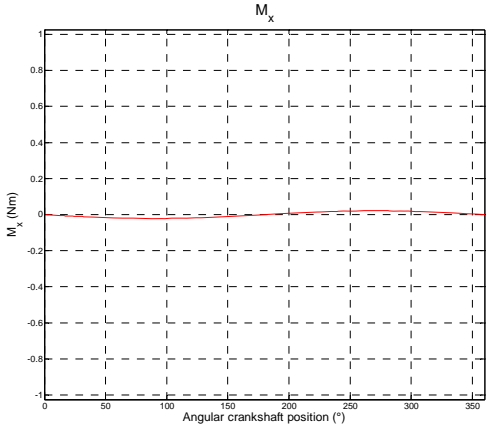
# Out-of-phase in-line engine with optimized crankshaft



## Out-of-phase in-line engine with two first order balance shafts

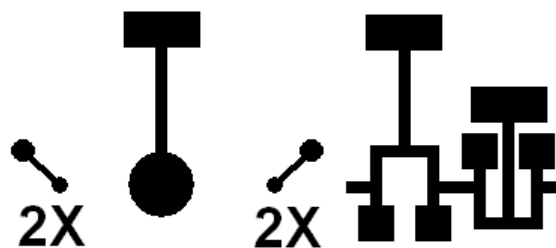
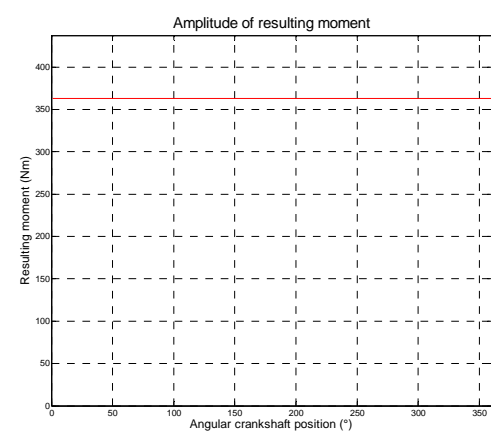
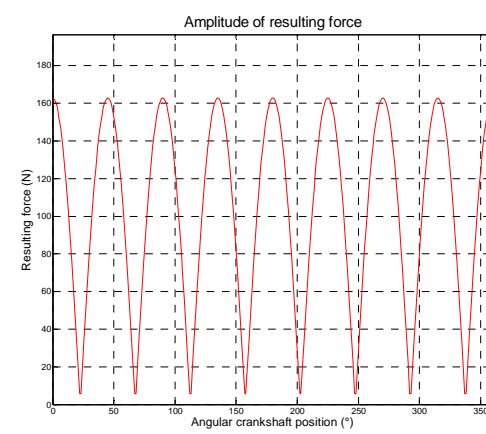
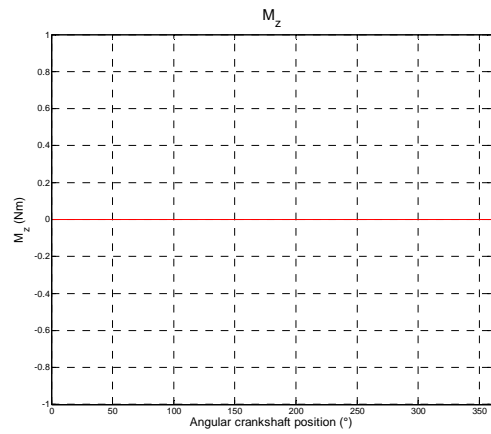
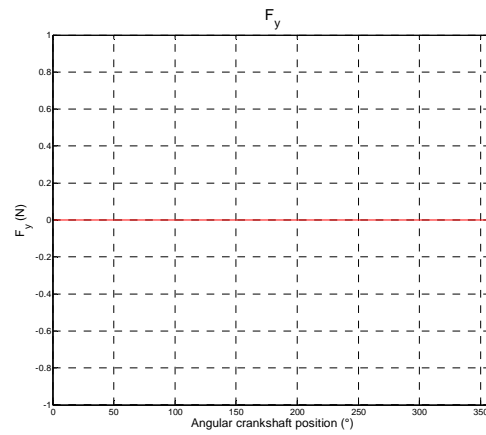
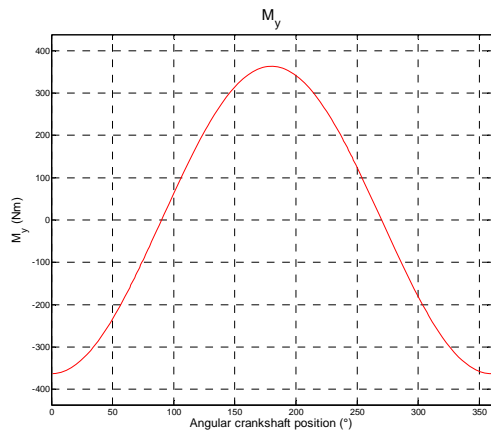
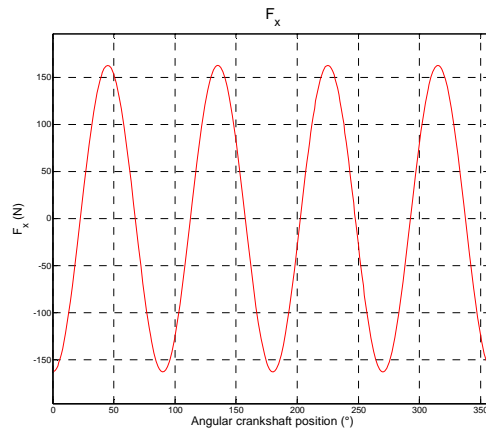
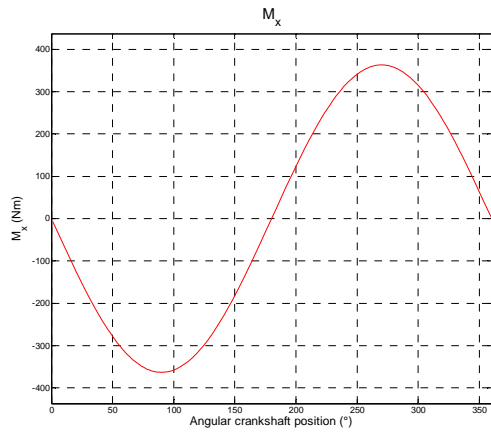


# Out-of-phase in-line engine with one first order balance shaft and optimized crankshaft

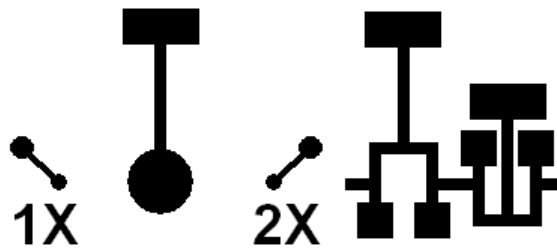
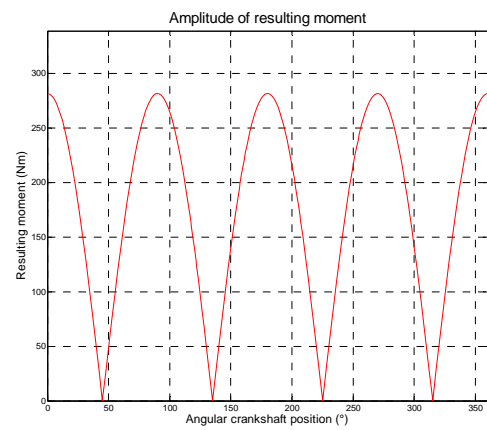
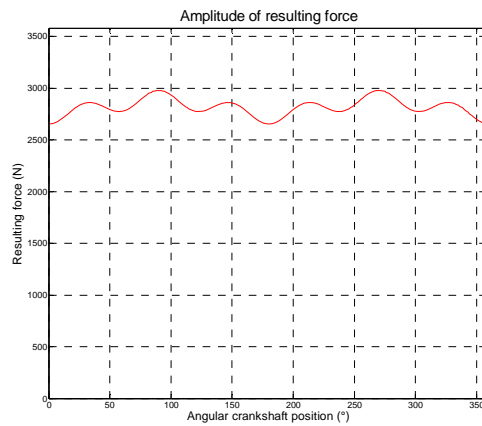
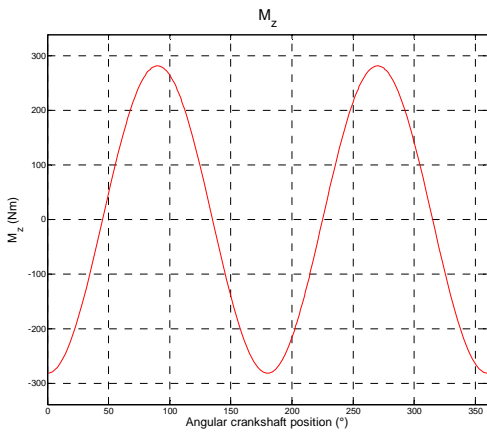
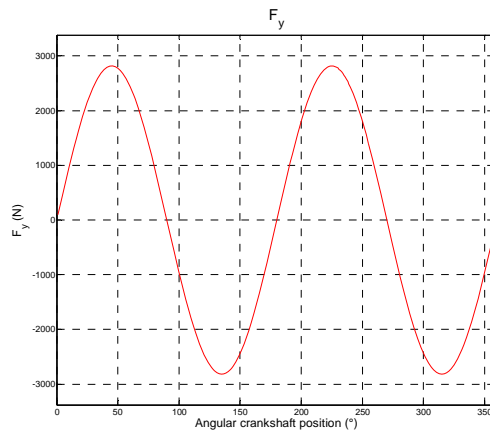
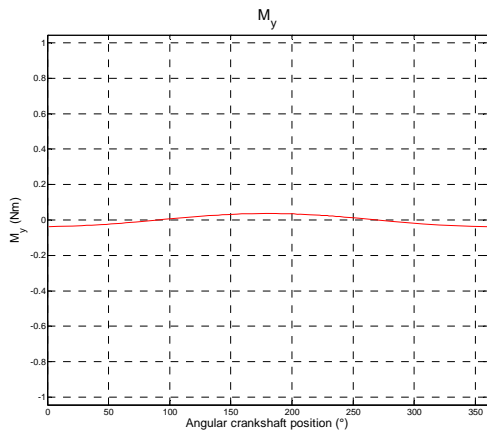
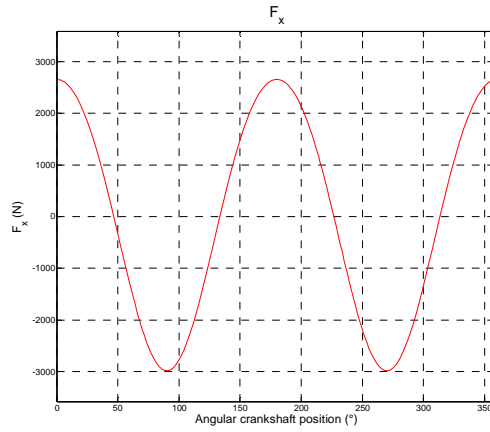
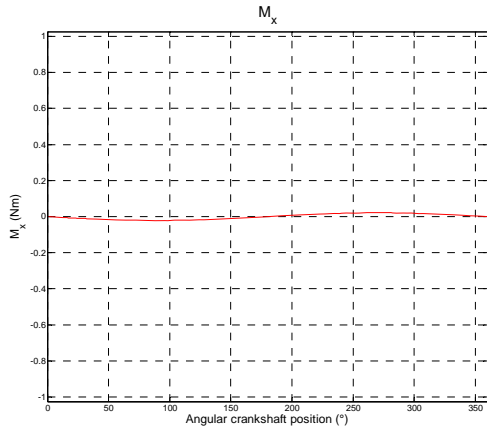




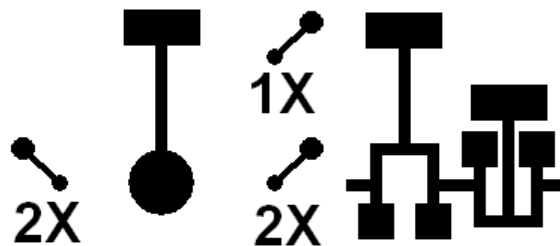
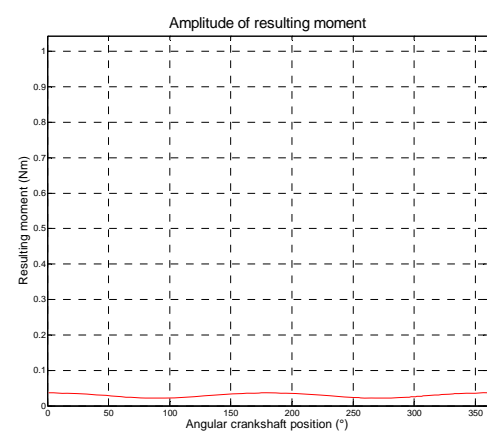
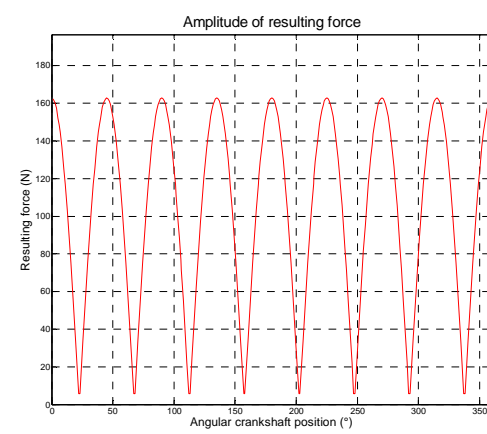
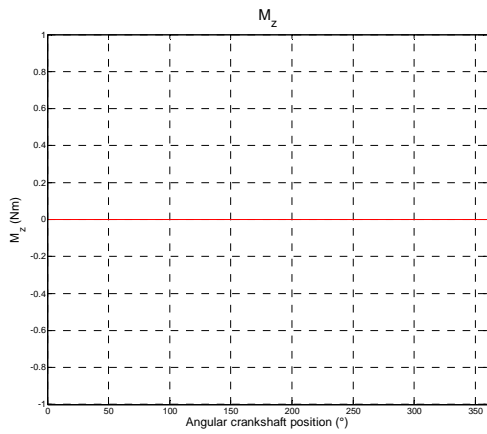
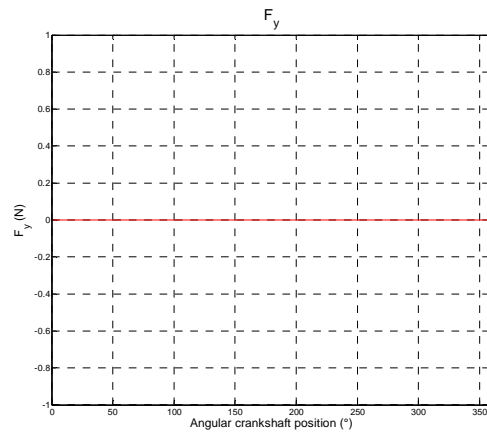
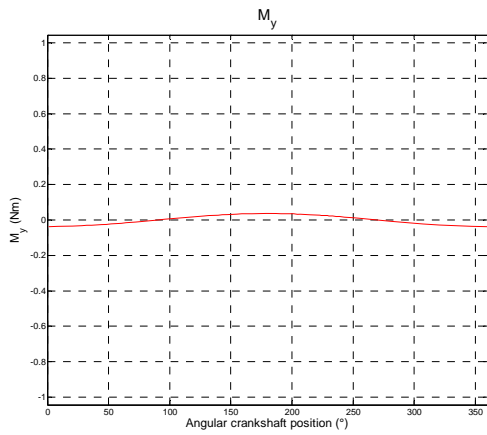
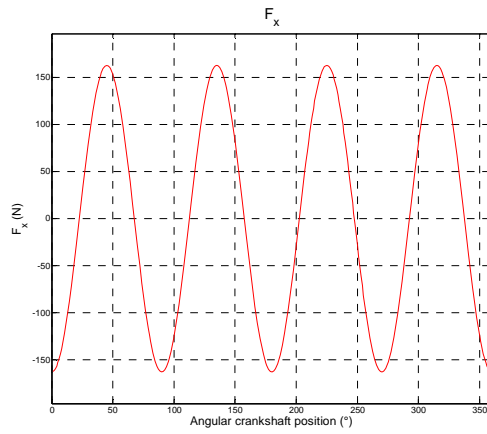
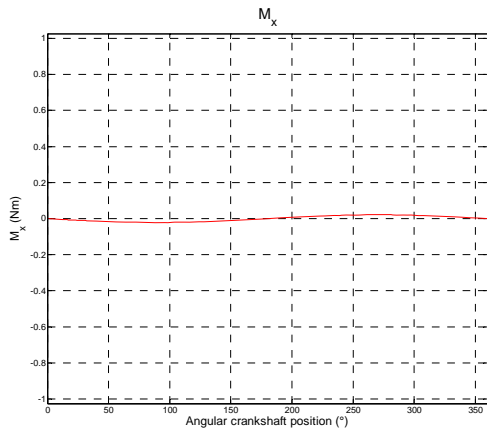
# Out-of-phase in-line engine with two second order balance shafts and optimized crankshaft



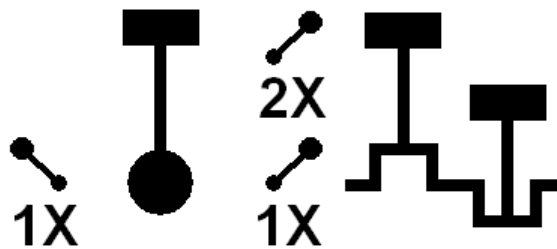
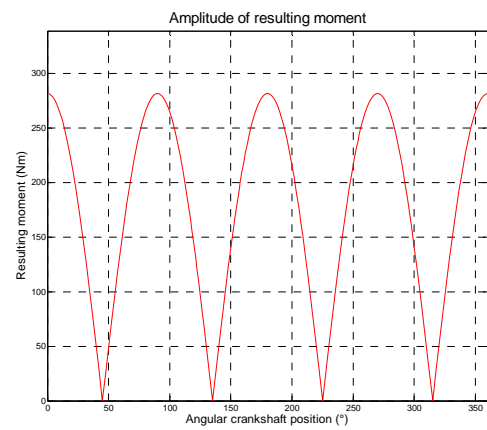
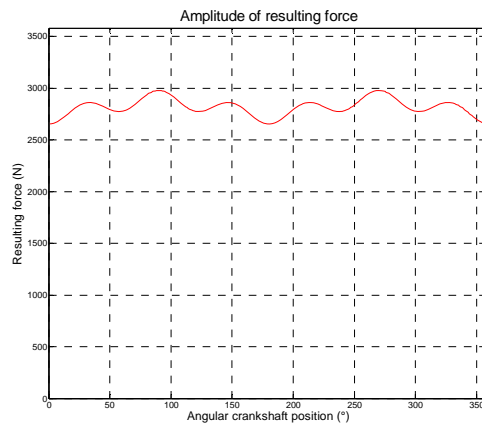
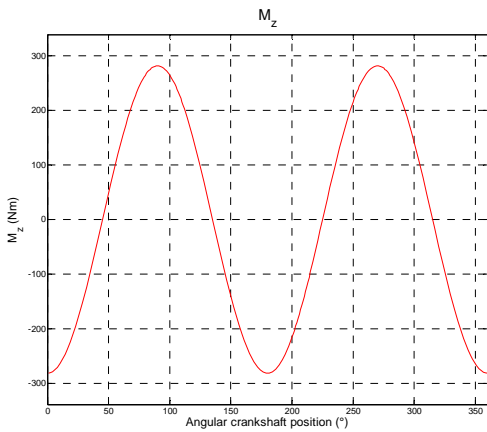
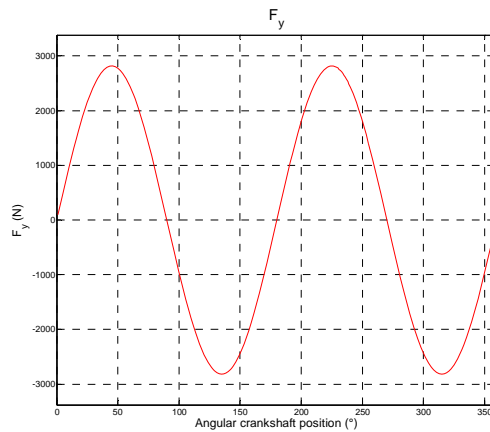
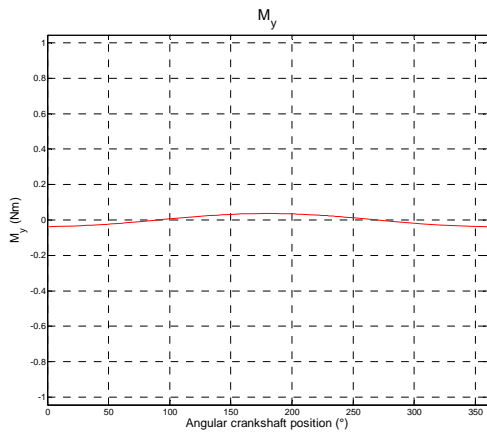
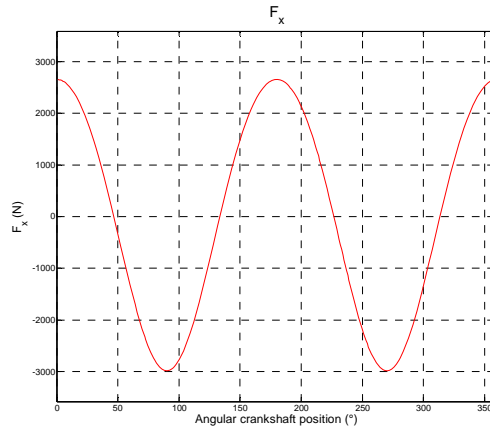
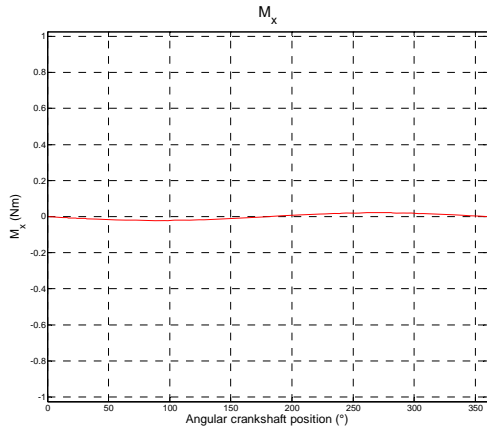
# Out-of-phase in-line engine with one first and one second order balance shafts



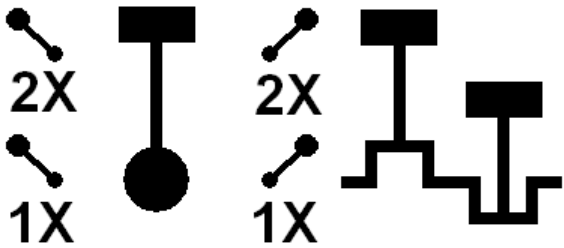
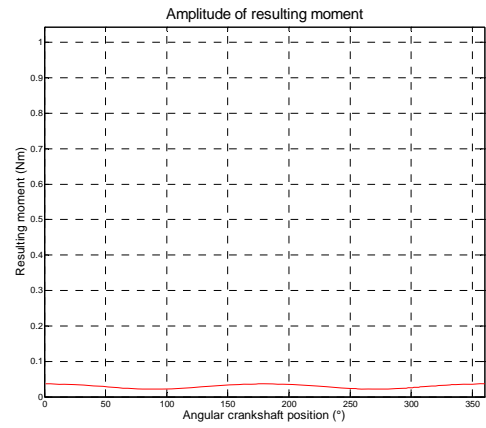
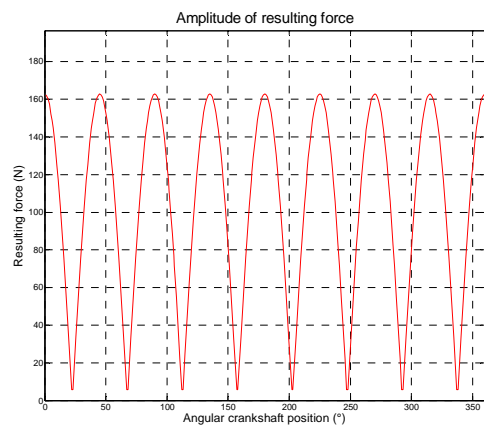
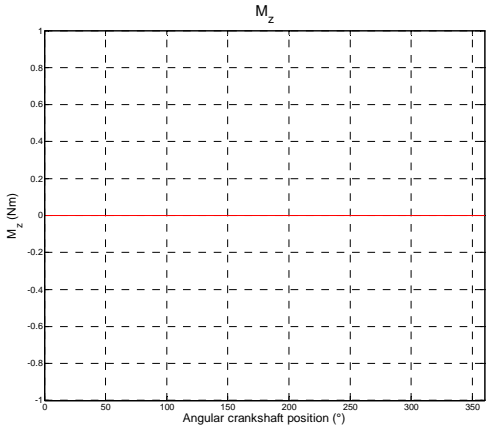
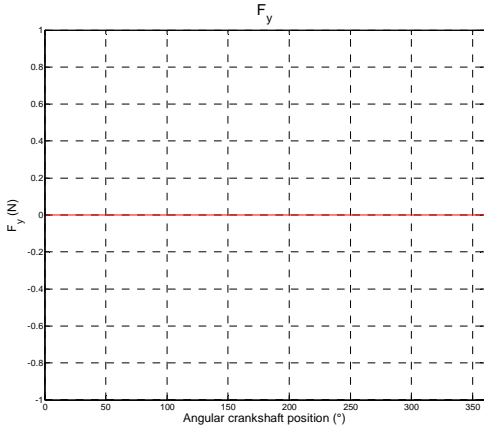
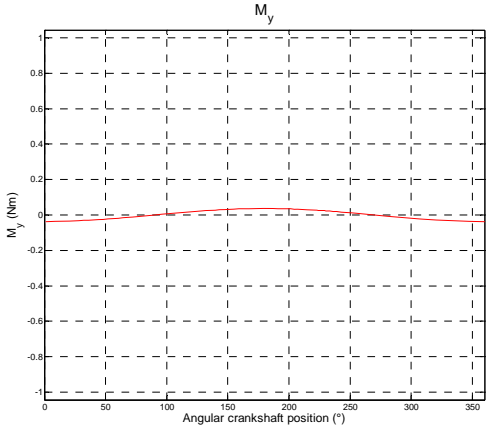
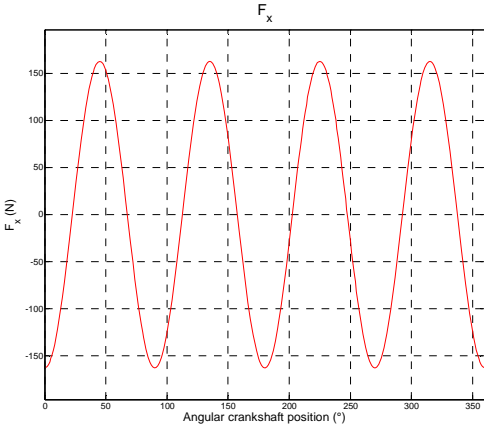
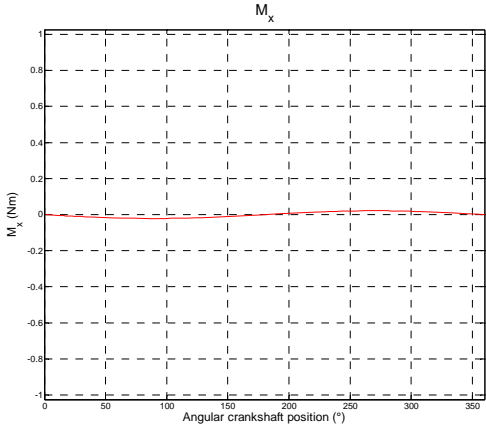
# Out-of-phase in-line engine with one first and two second order balance shafts



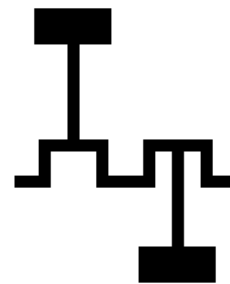
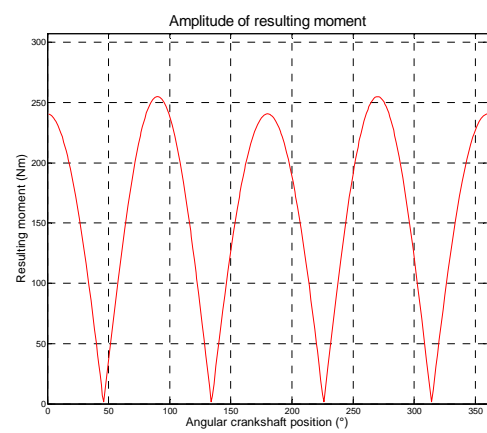
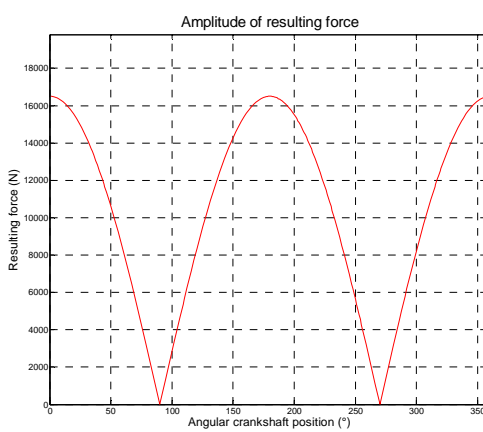
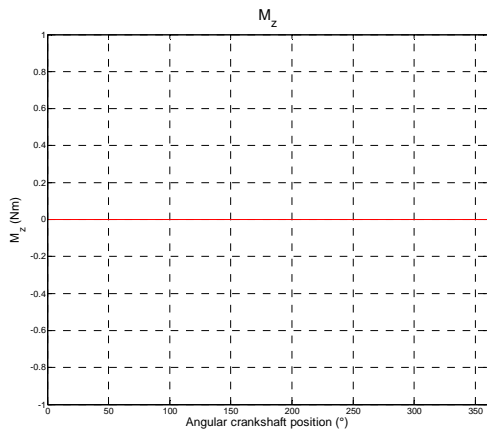
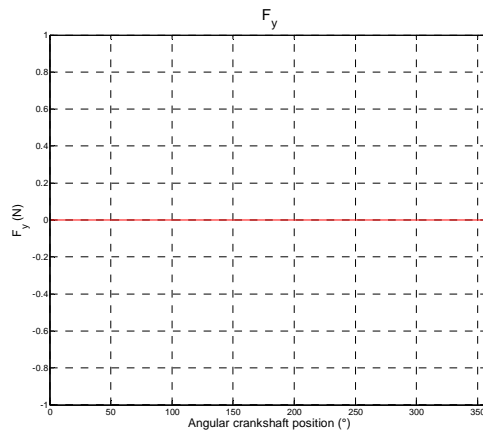
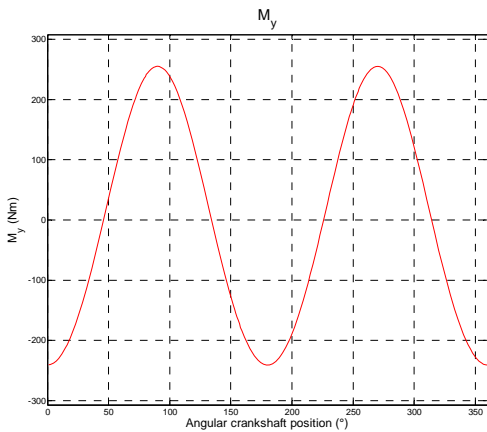
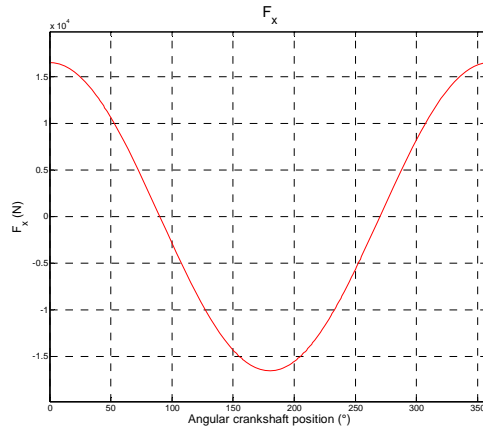
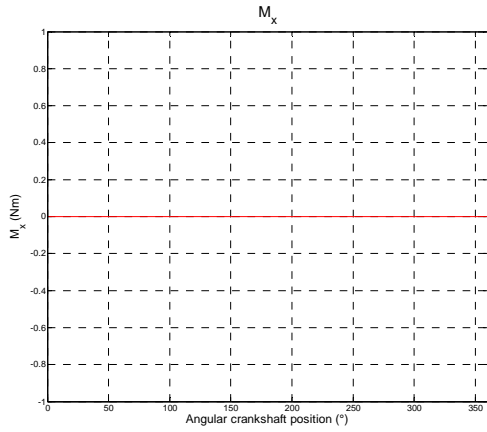
# Out-of-phase in-line engine with two first and one second order balance shafts



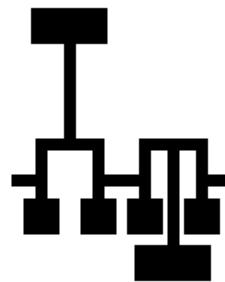
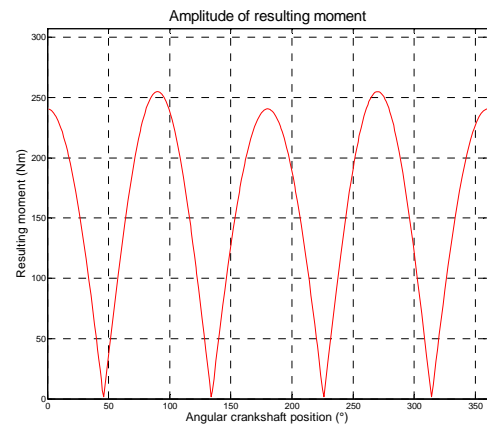
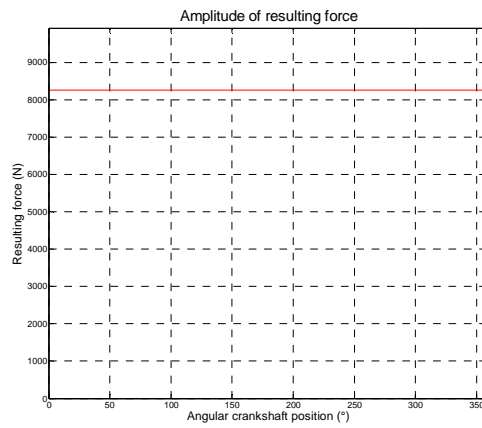
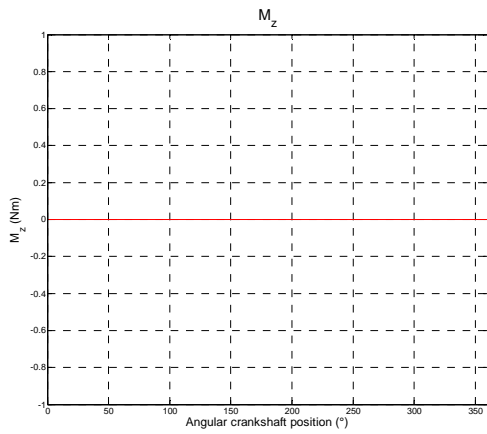
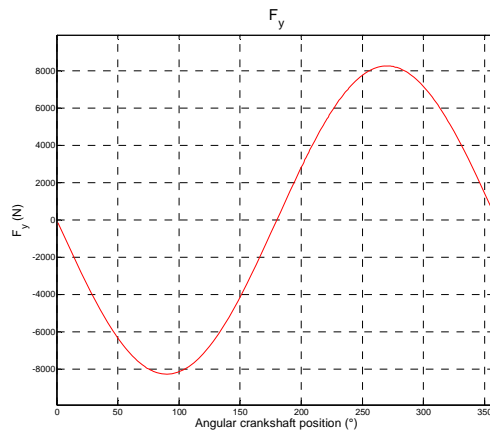
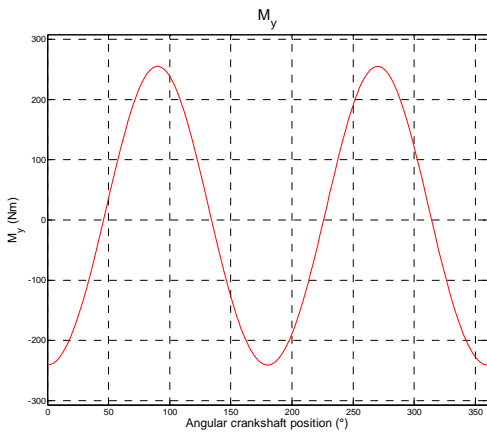
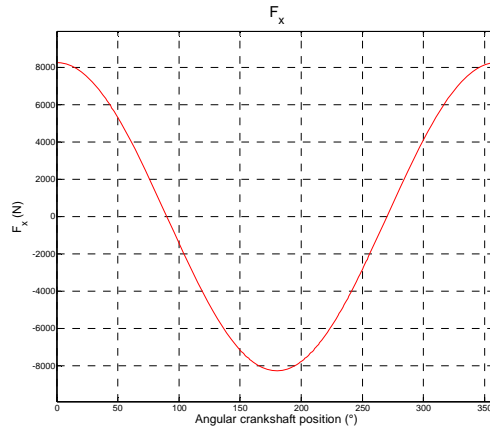
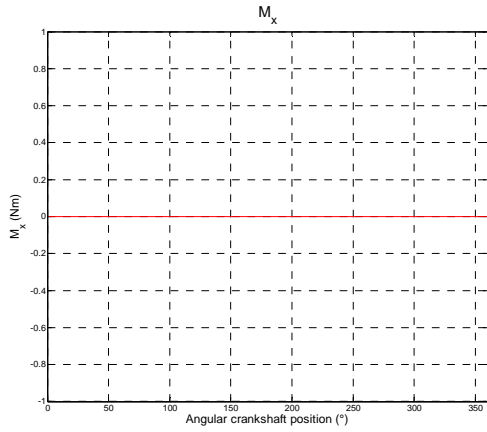
Out-of-phase in-line engine with two first and two second order balance shafts



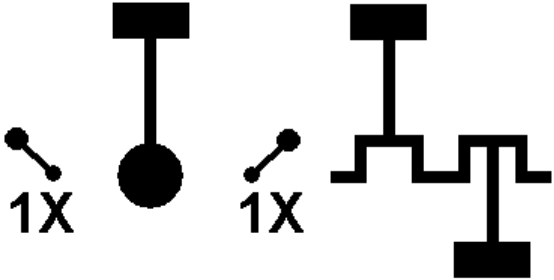
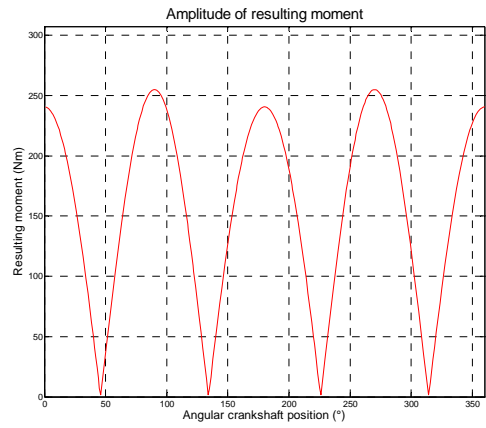
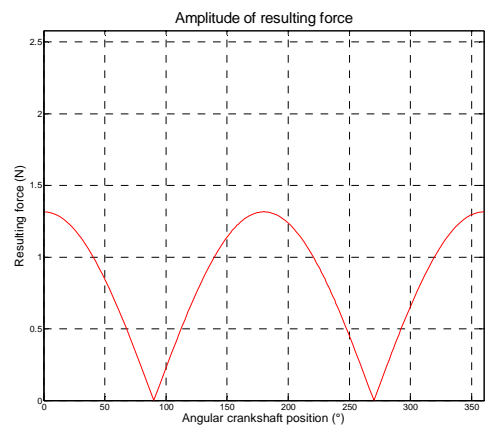
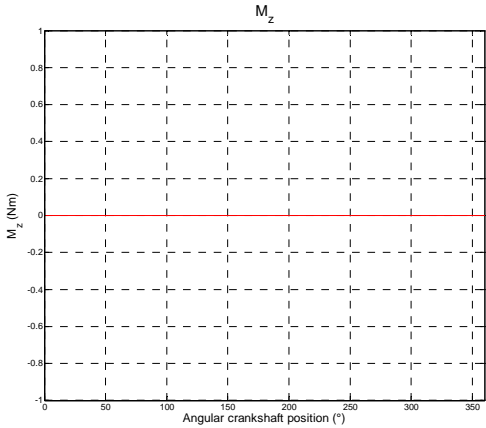
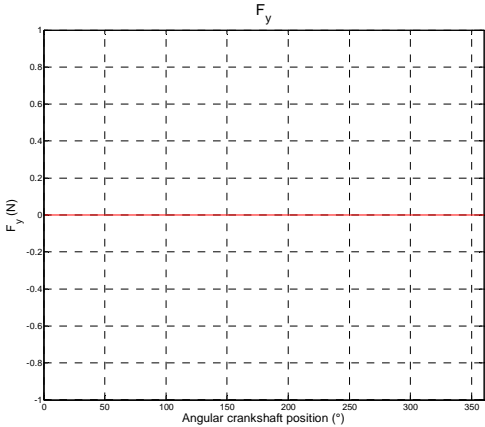
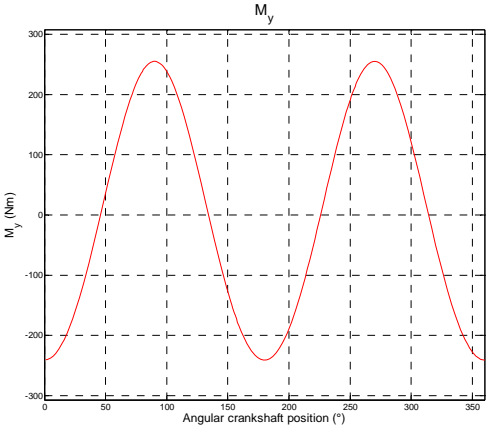
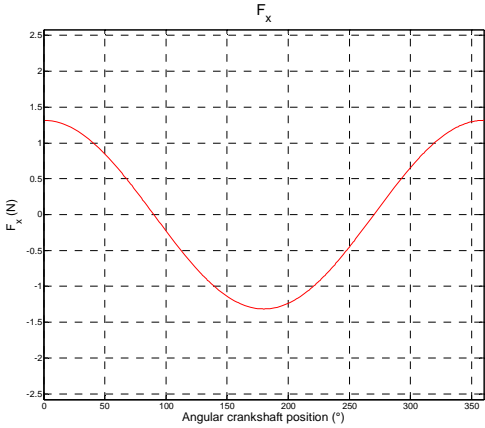
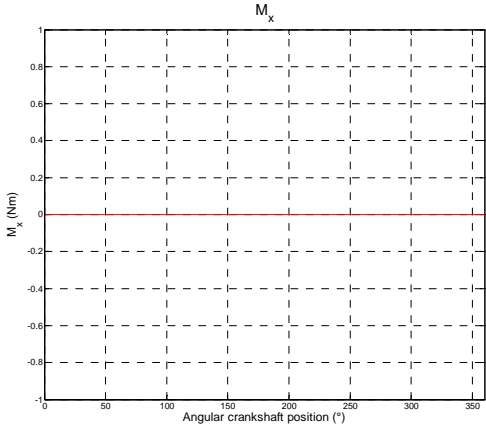
# Out-of-phase boxer engine



# Out-of-phase boxer engine with optimized crankshaft

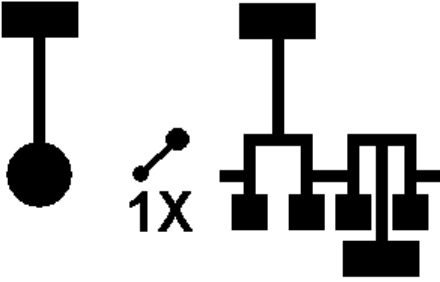
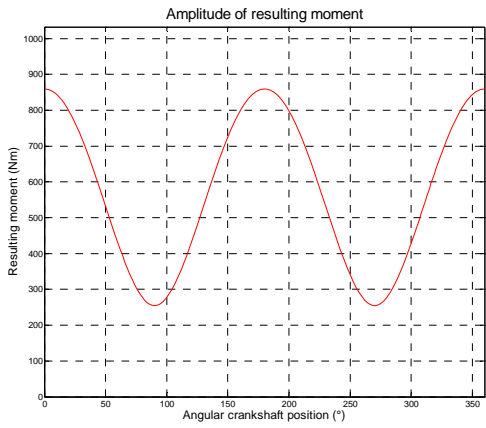
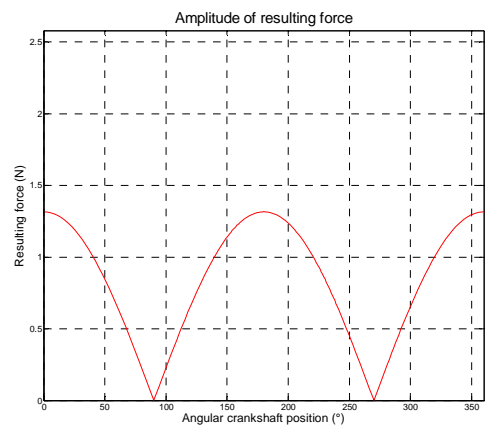
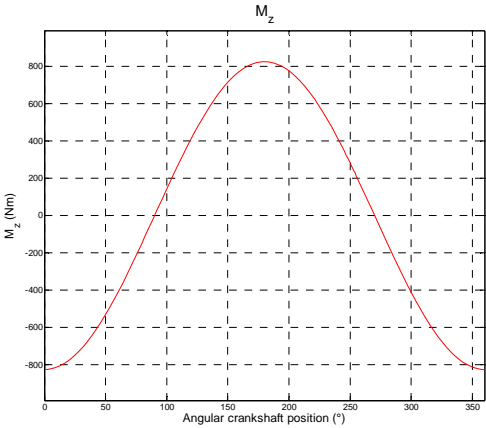
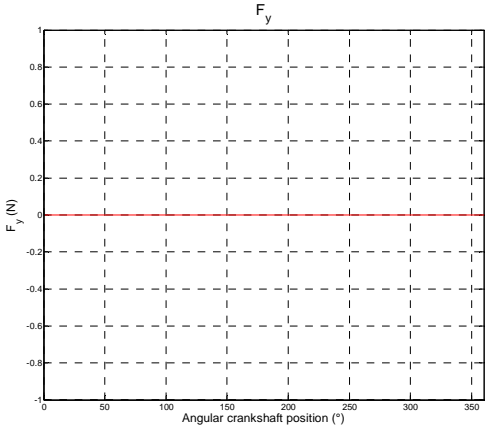
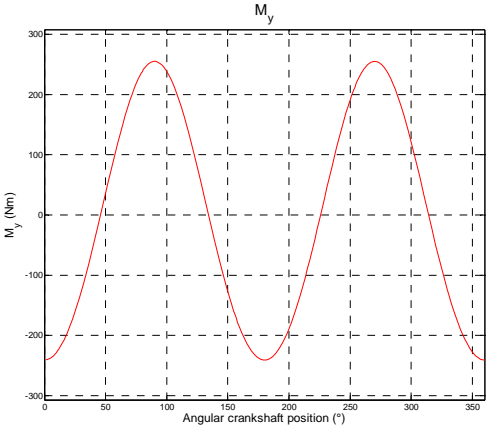
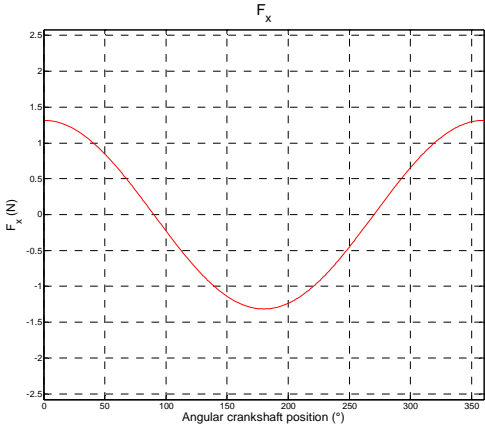
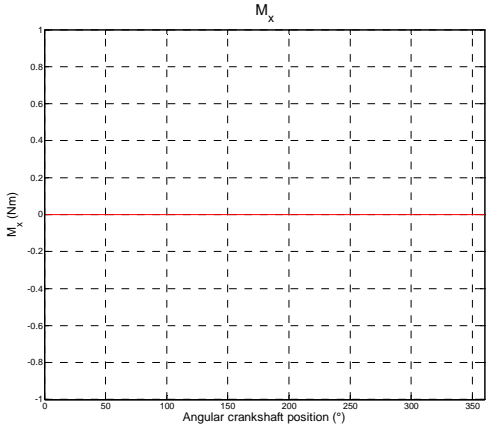


Out-of-phase boxer engine with two first order balance shafts

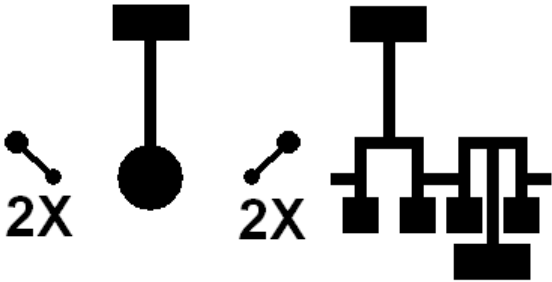
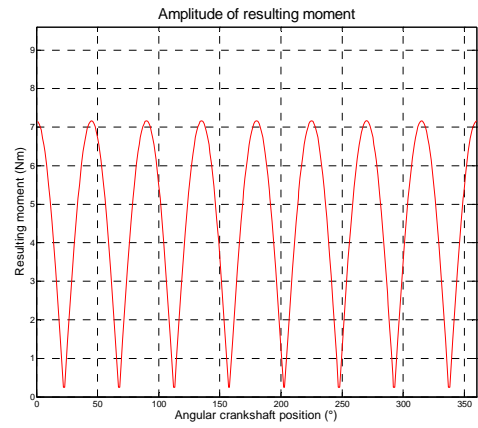
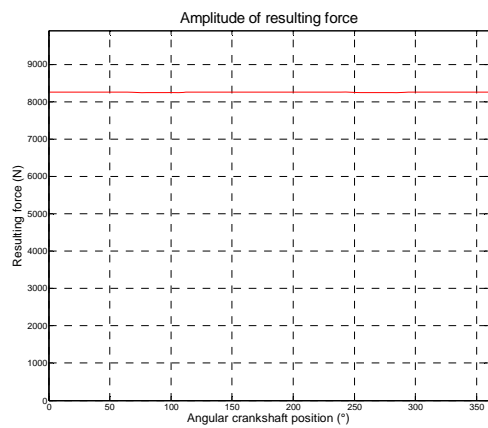
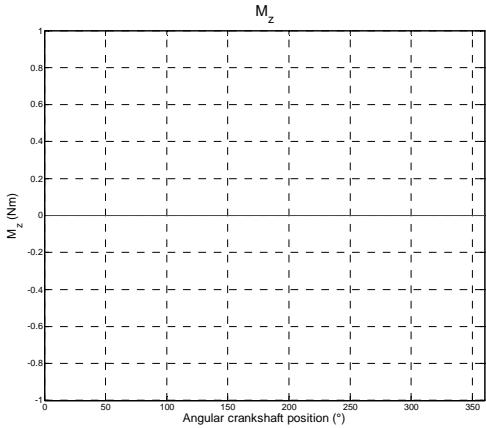
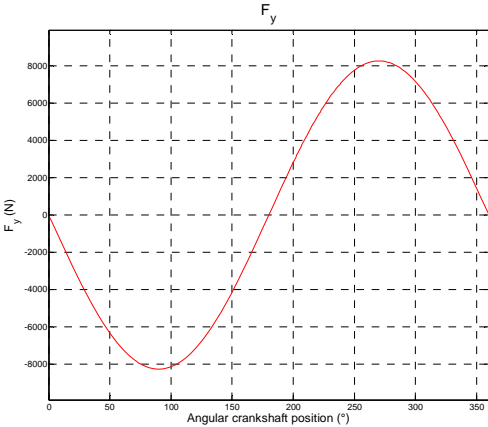
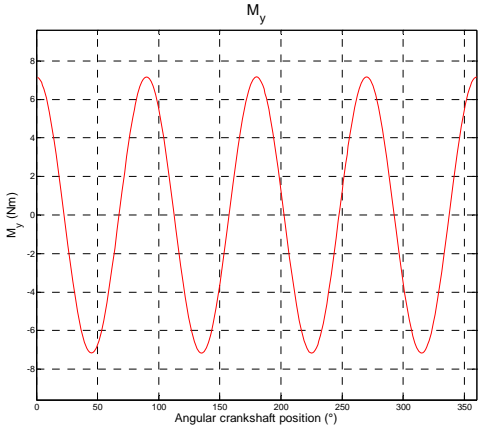
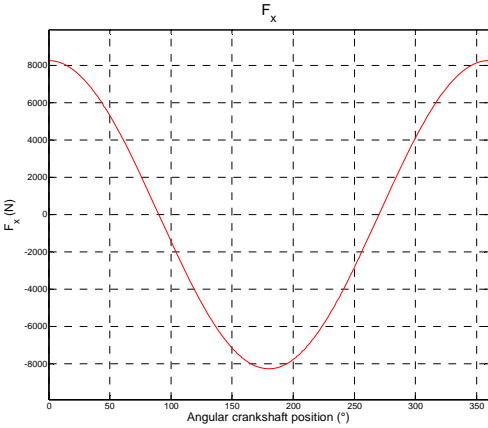
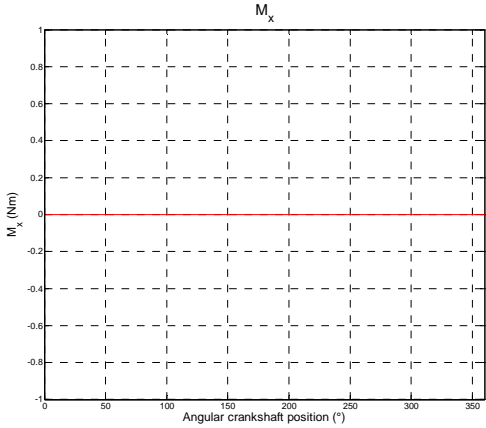




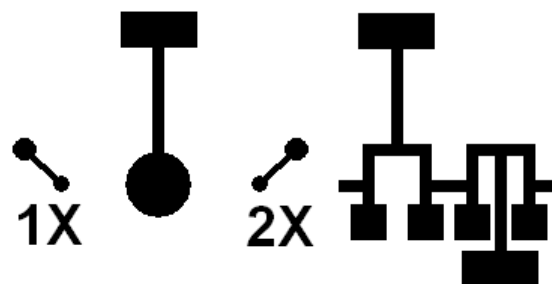
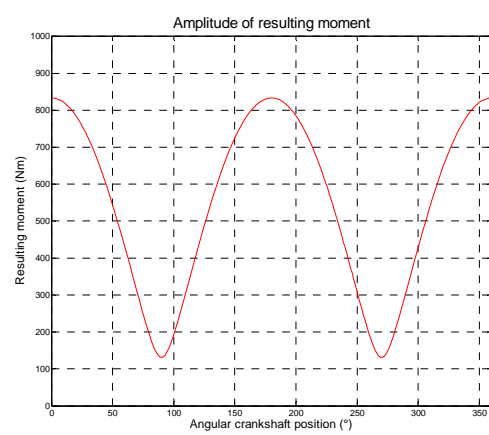
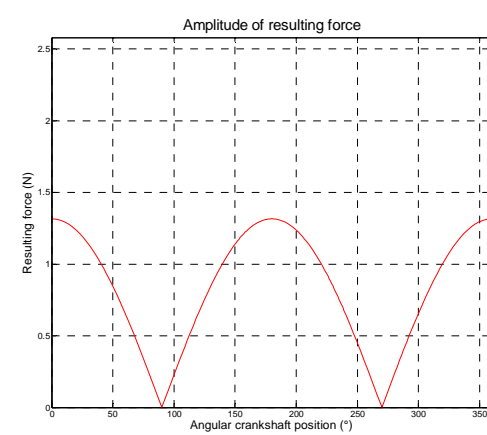
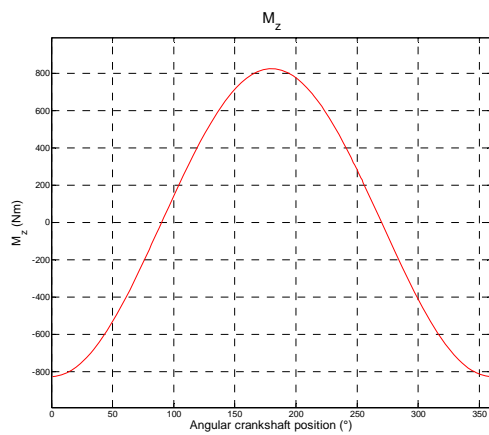
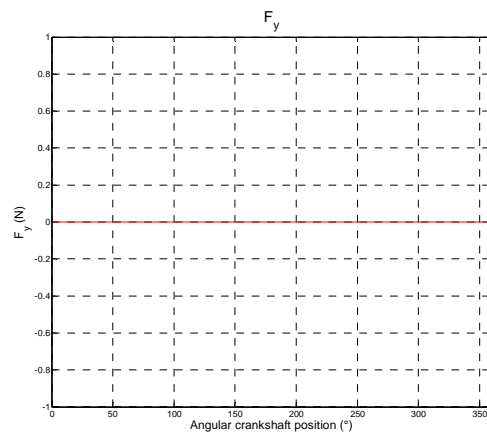
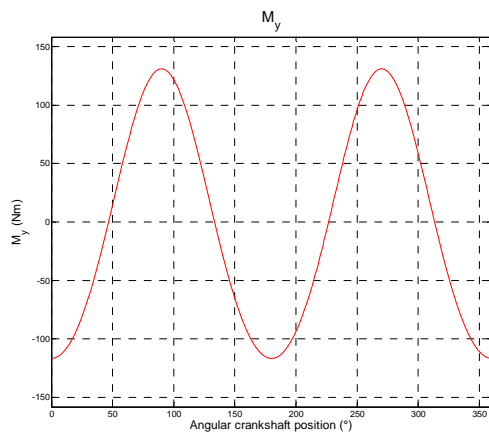
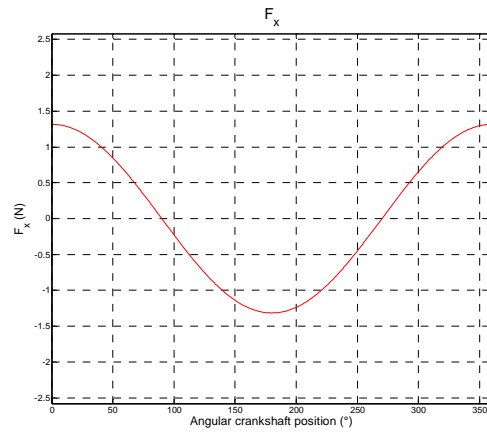
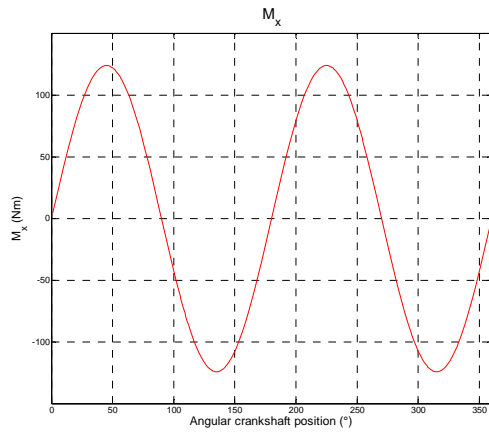
# Out-of-phase boxer engine with one first order balance shaft and optimized crankshaft



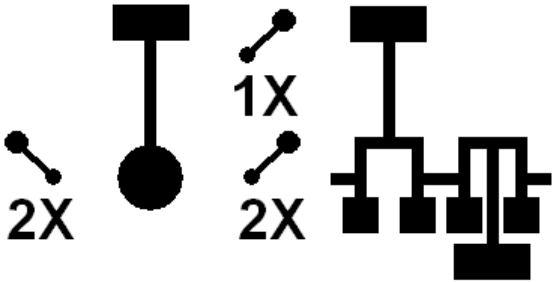
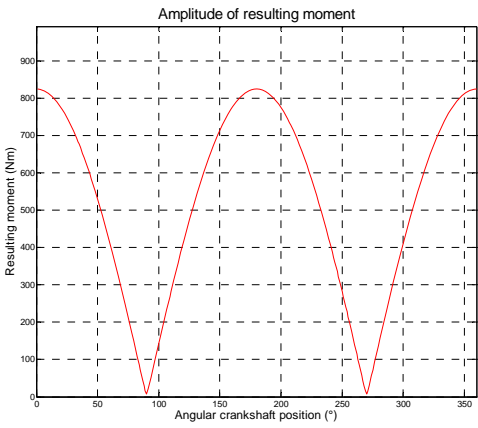
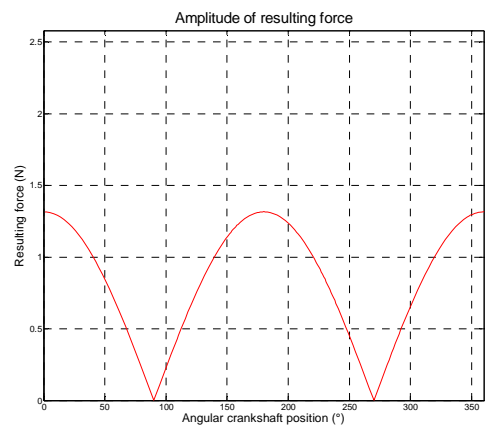
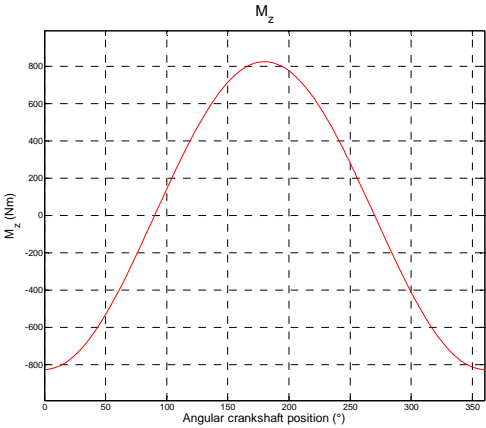
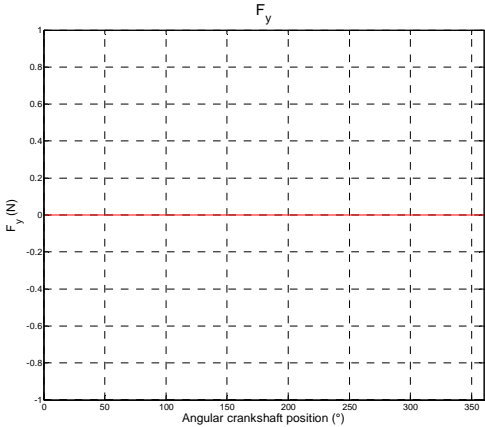
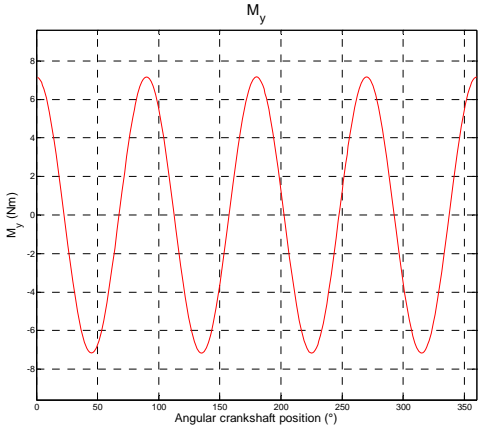
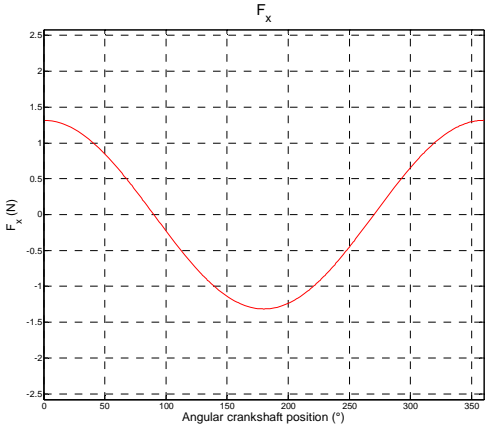
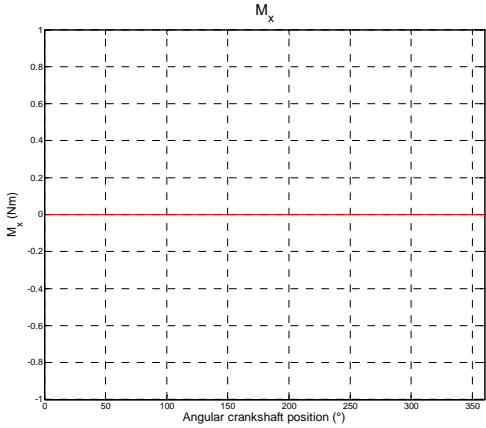
Out-of-phase boxer engine with two second order balance shafts and optimized crankshaft



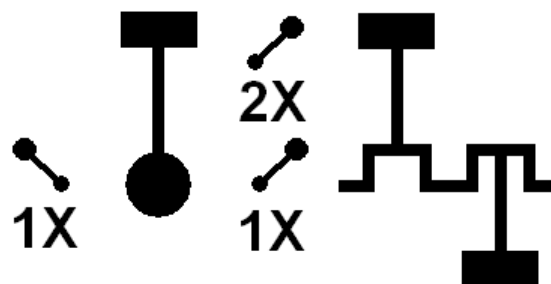
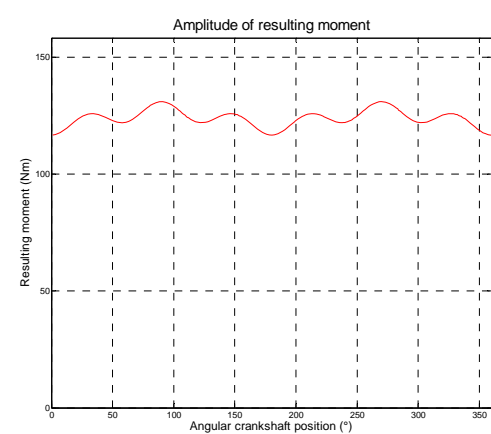
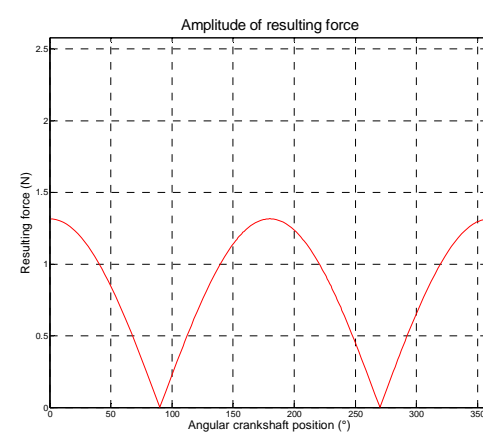
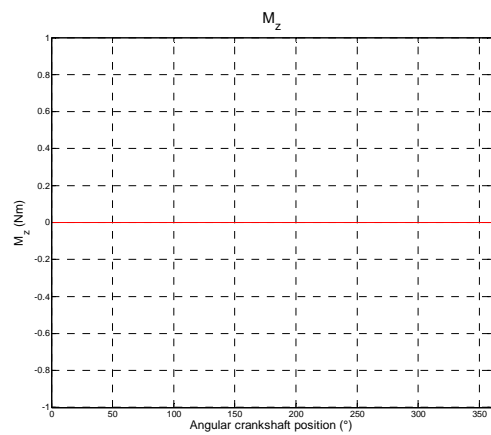
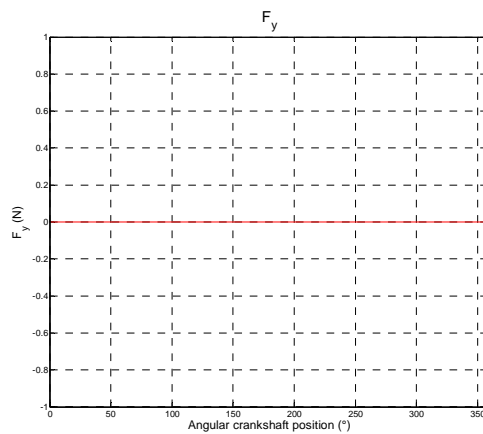
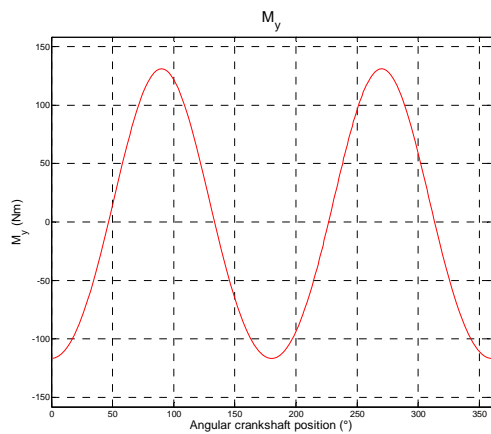
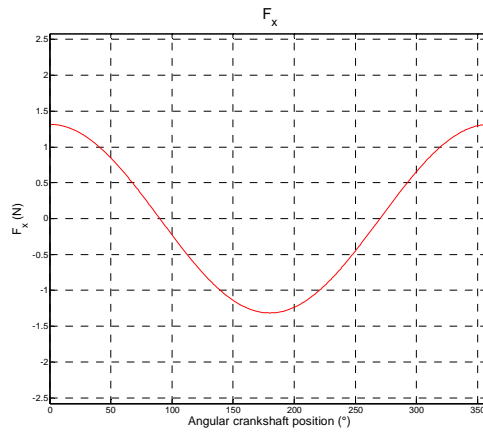
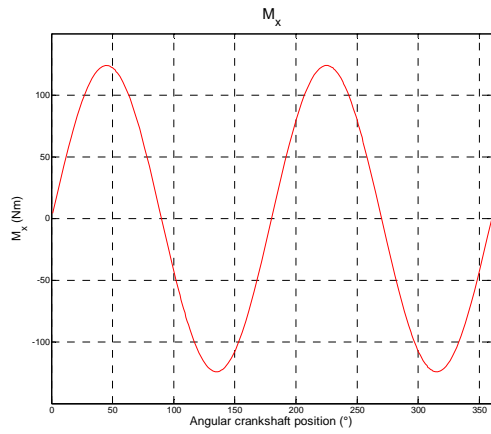
## Out-of-phase boxer engine with one first and one second order balance shafts



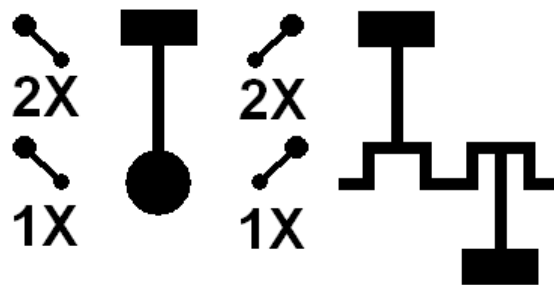
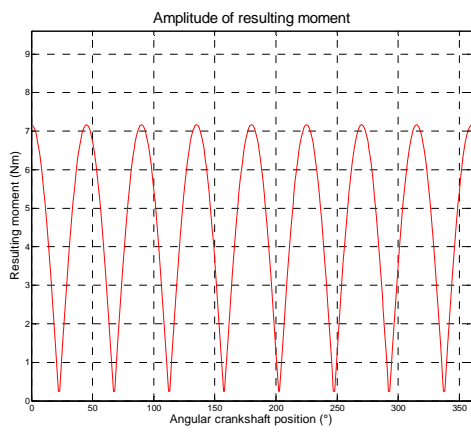
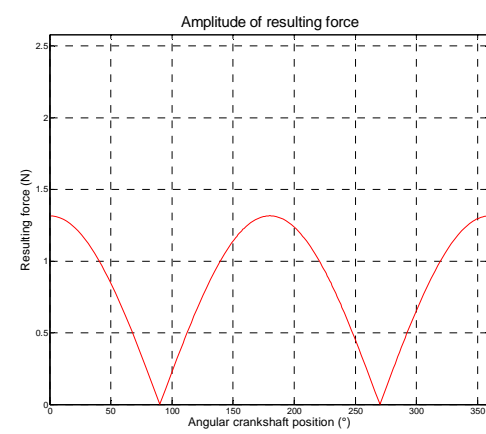
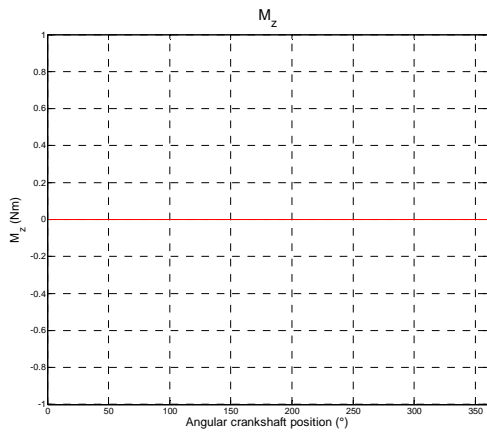
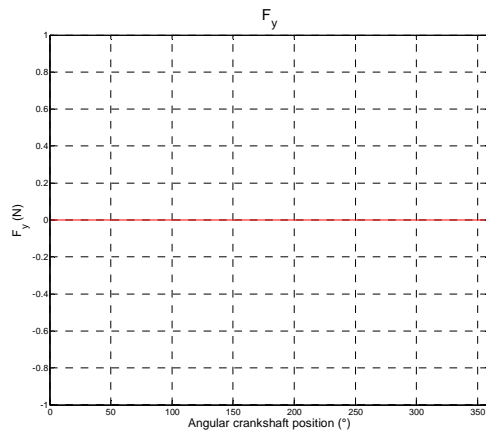
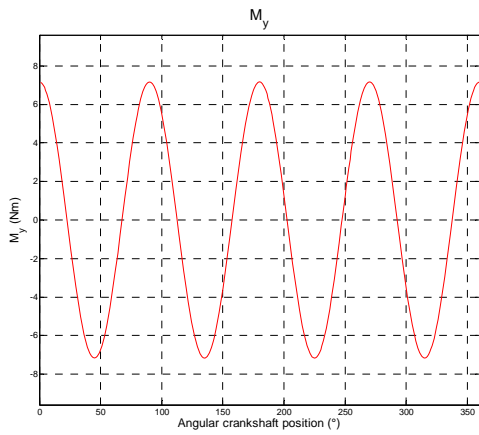
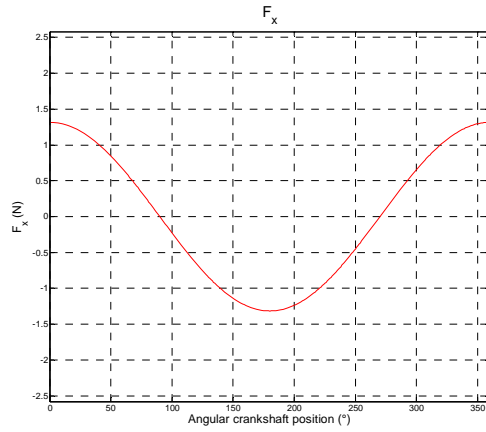
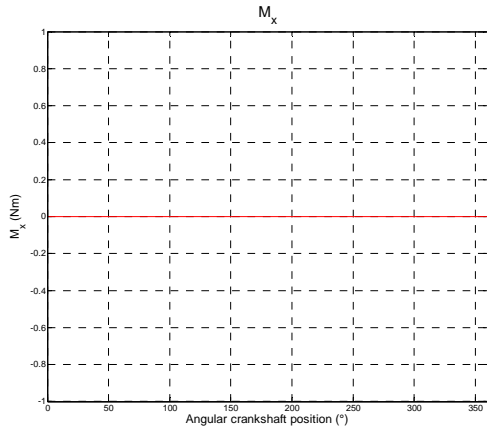
# Out-of-phase boxer engine with one first and two second order balance shafts



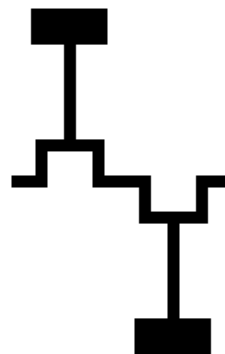
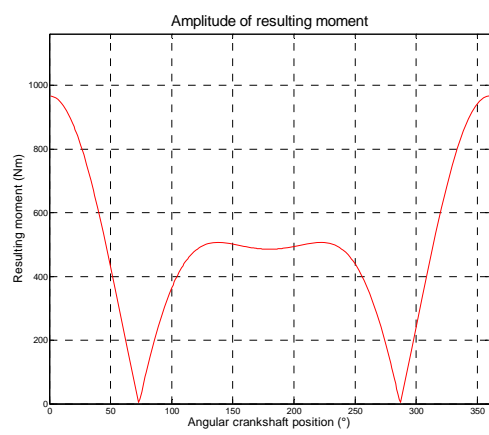
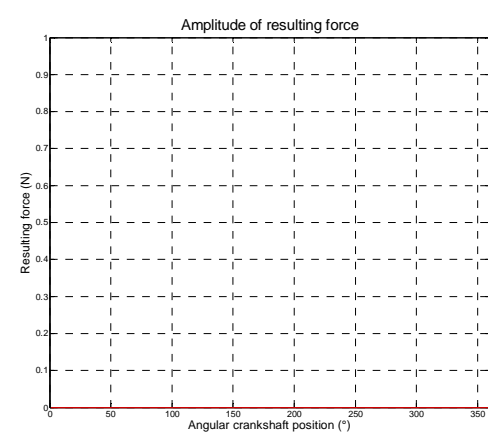
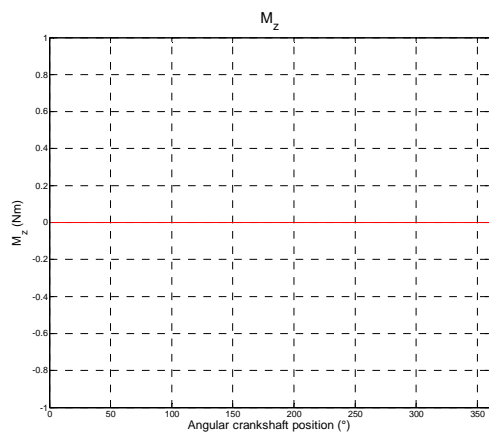
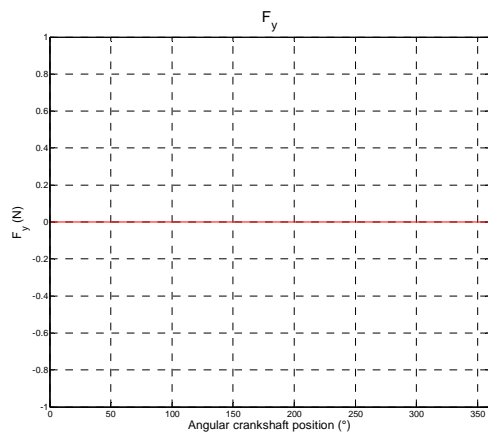
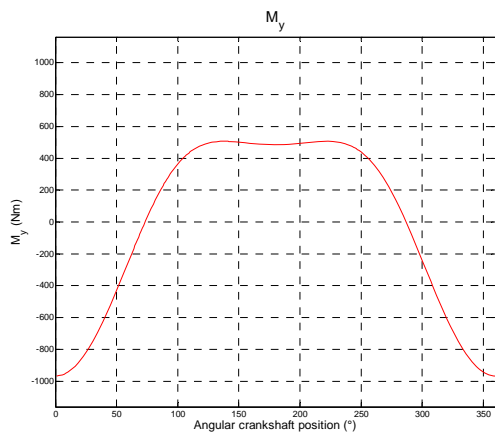
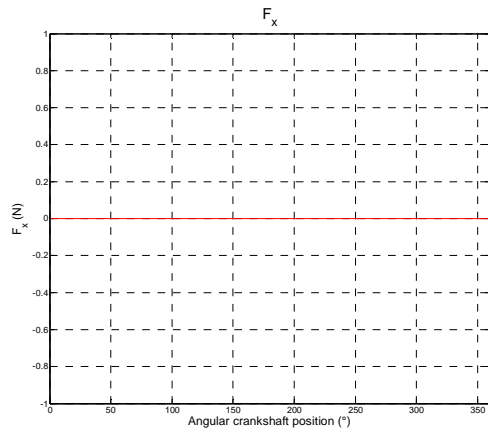
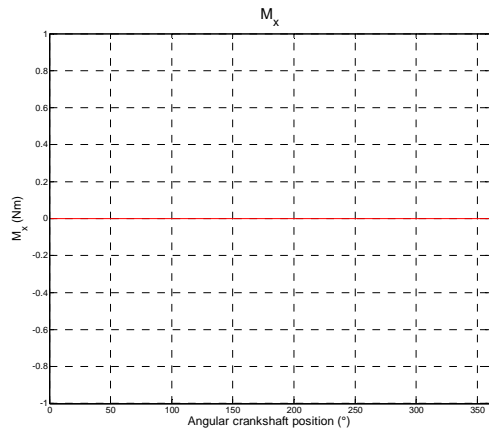
# Out-of-phase boxer engine with two first and one second order balance shafts



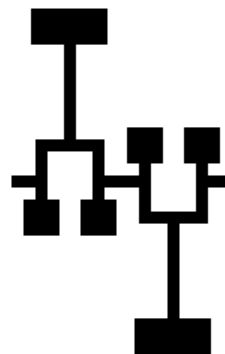
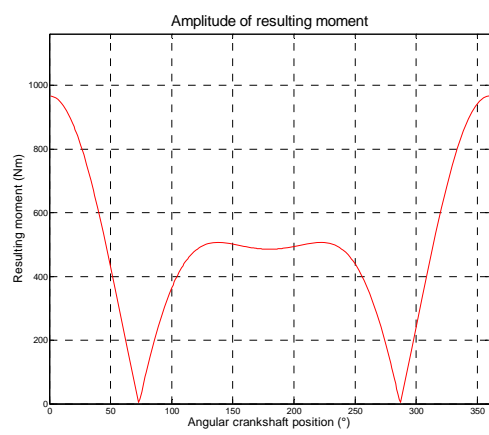
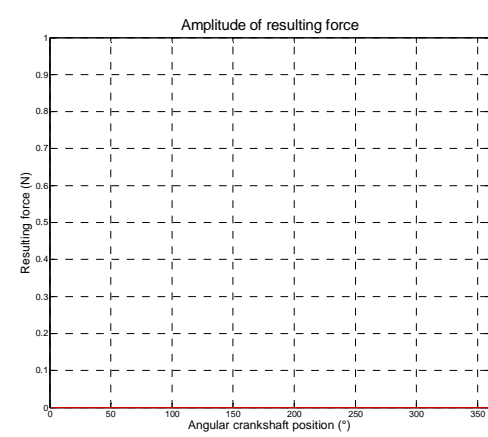
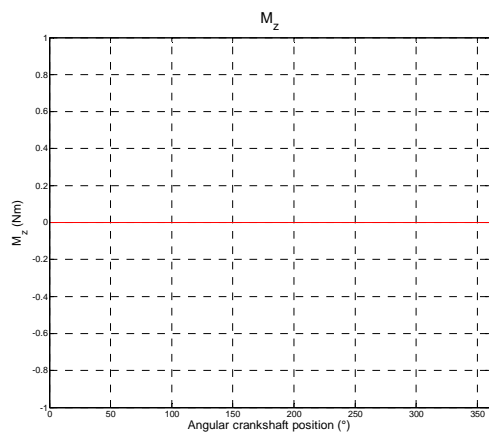
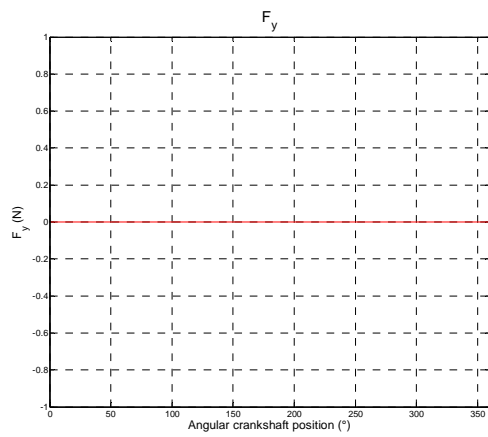
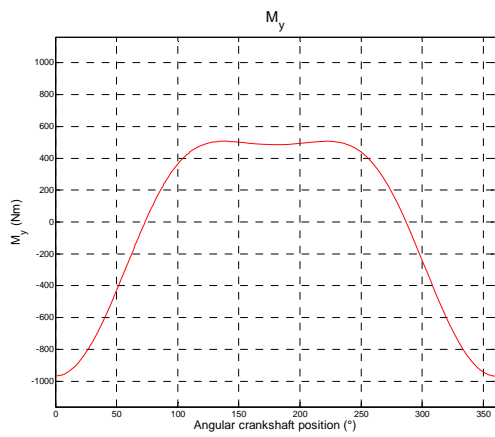
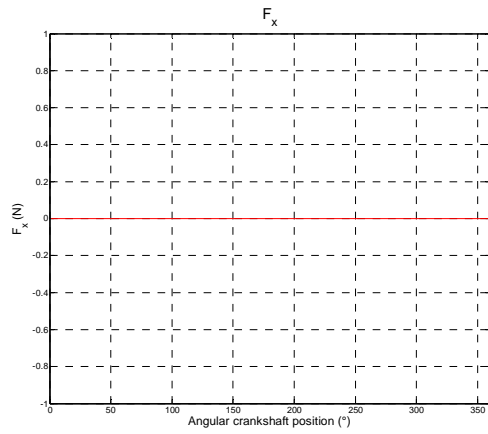
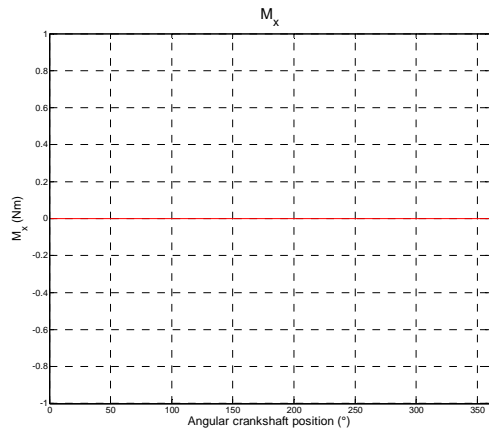
# Out-of-phase boxer engine with two first and two second order balance shafts



# In-phase boxer engine

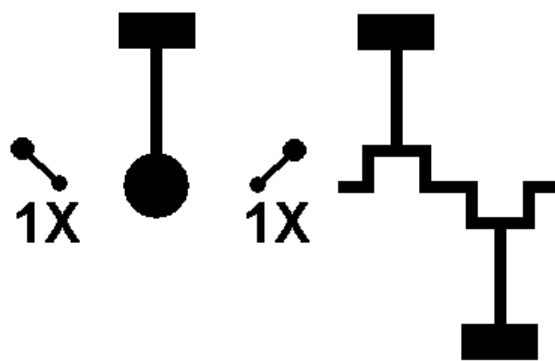
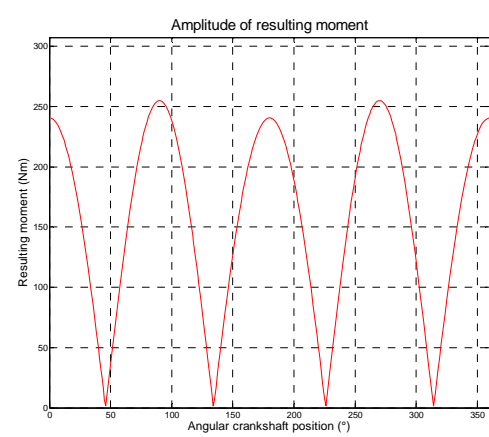
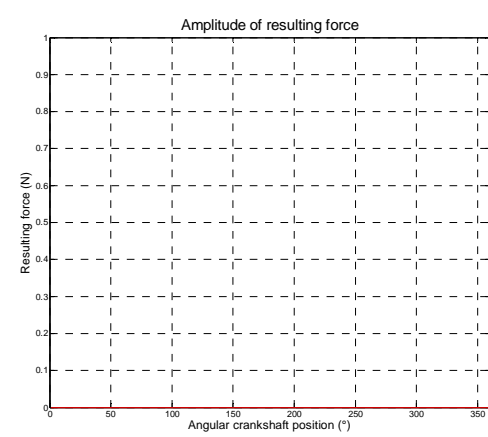
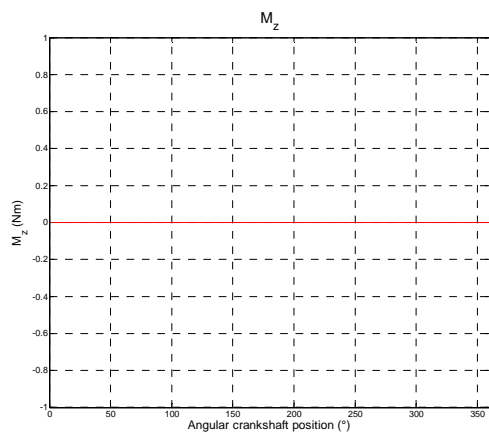
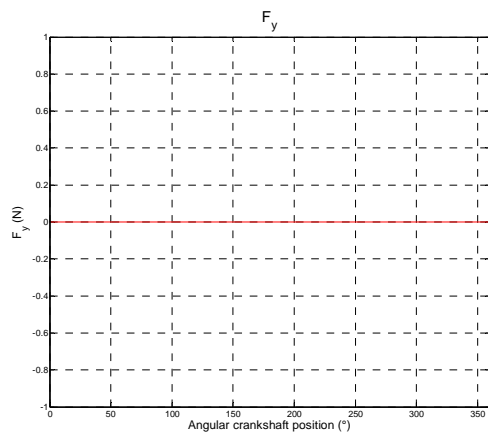
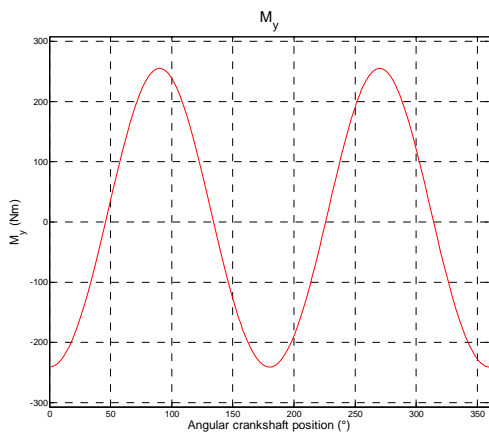
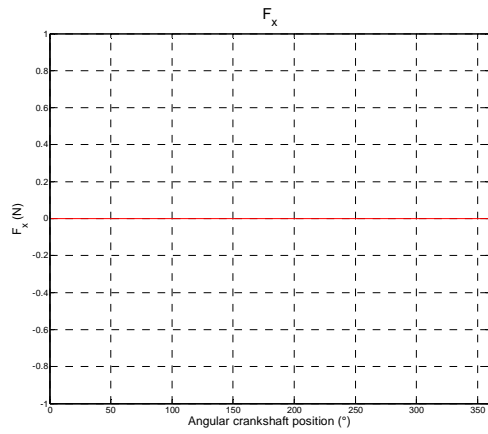
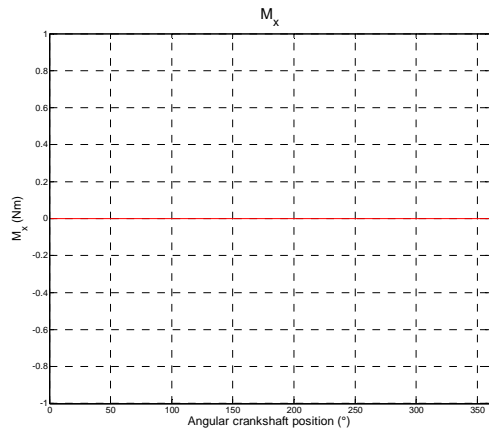


# In-phase boxer engine with optimized crankshaft

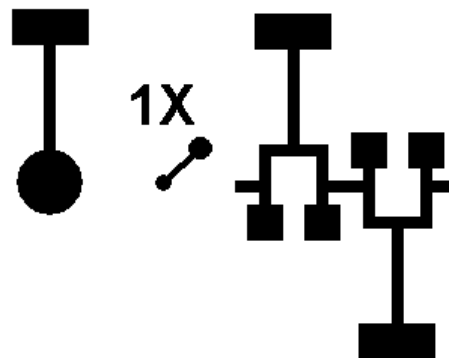
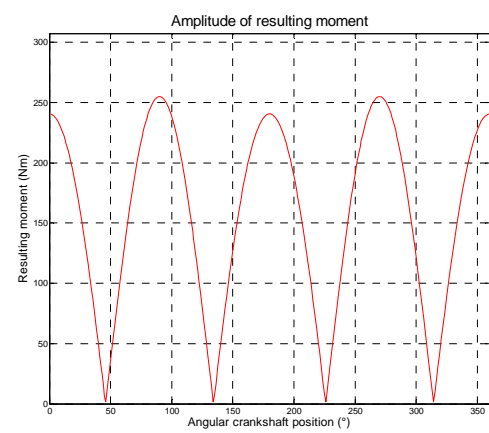
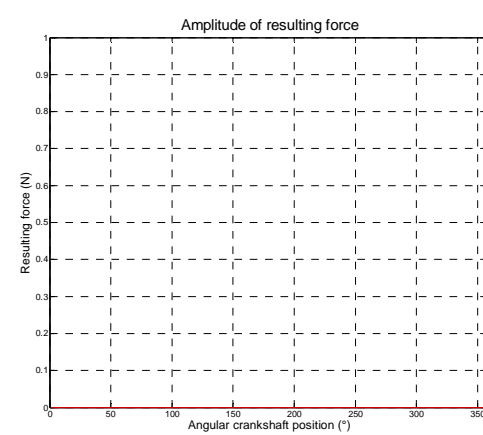
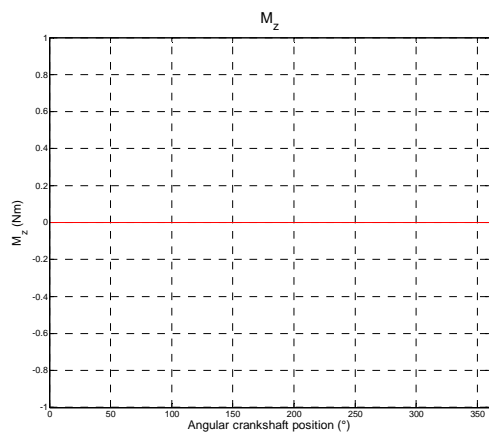
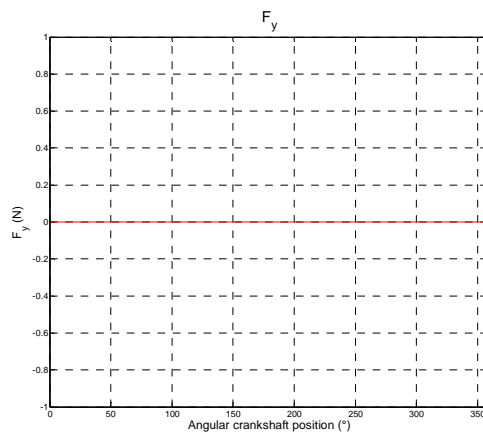
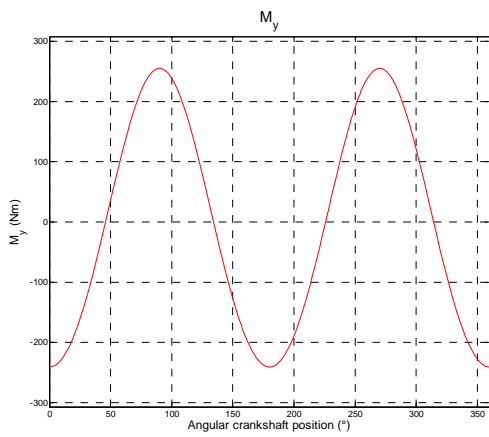
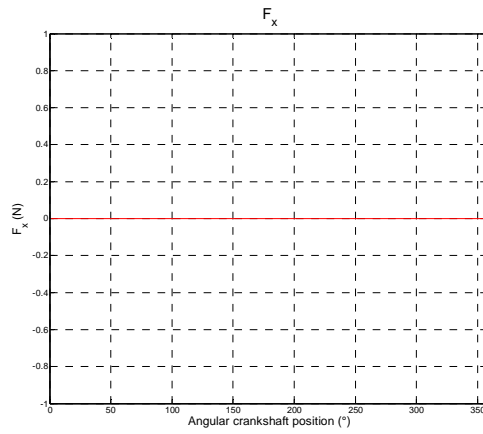
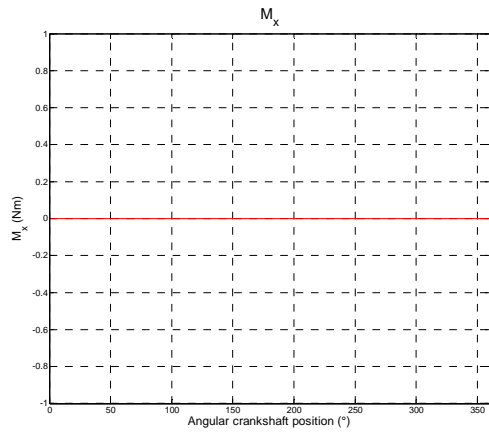




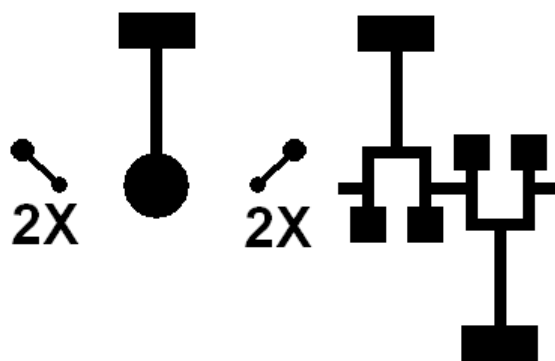
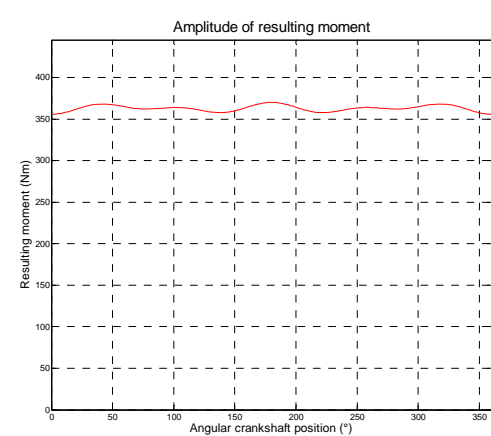
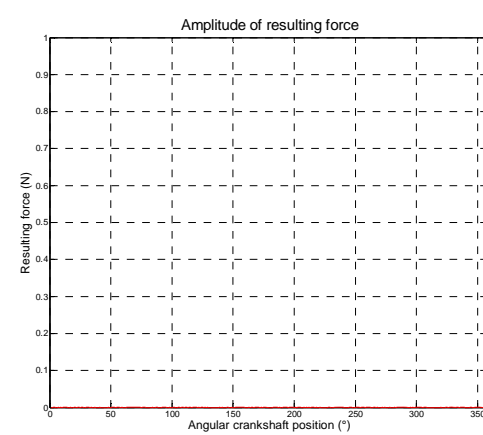
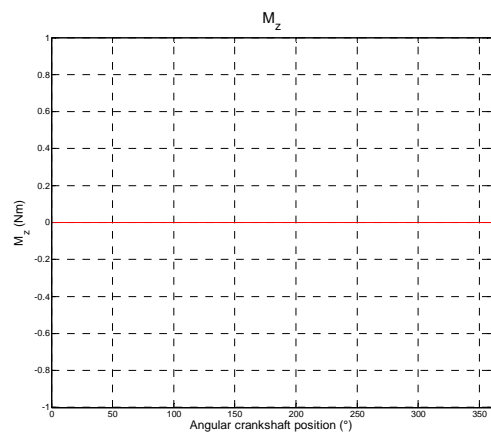
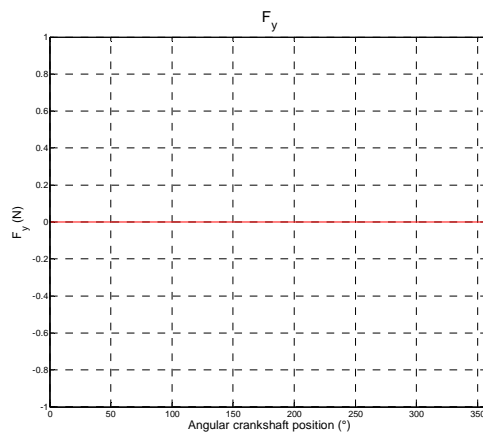
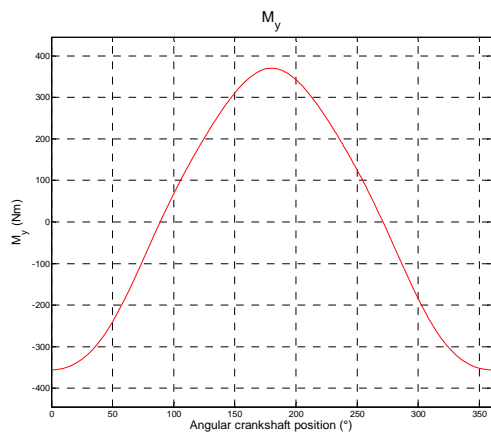
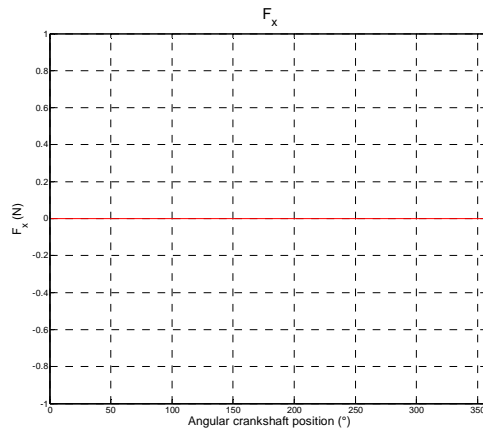
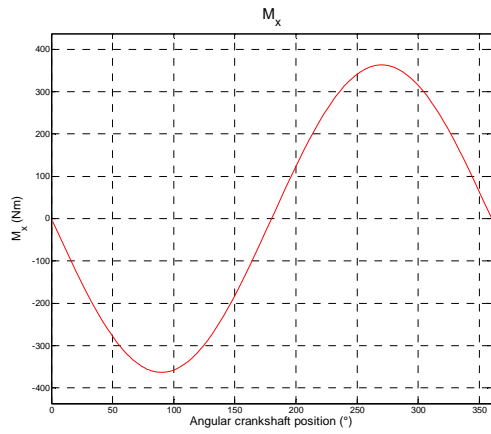
# In-phase boxer engine with two first order balance shafts



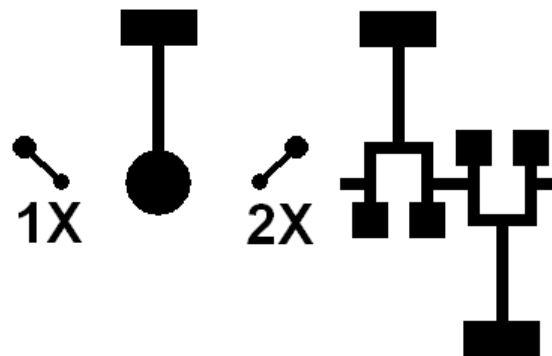
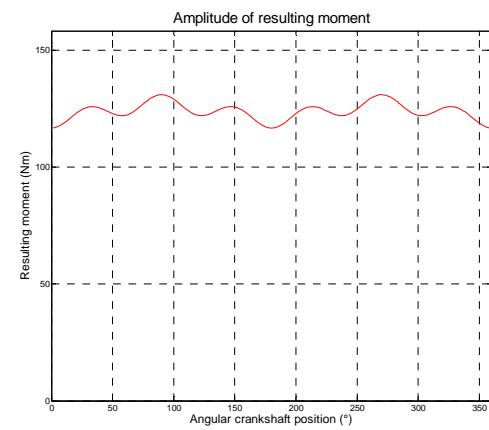
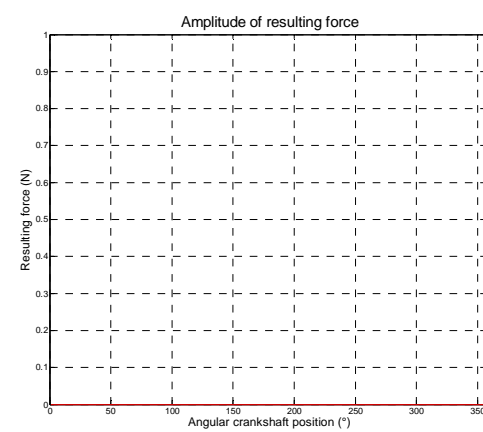
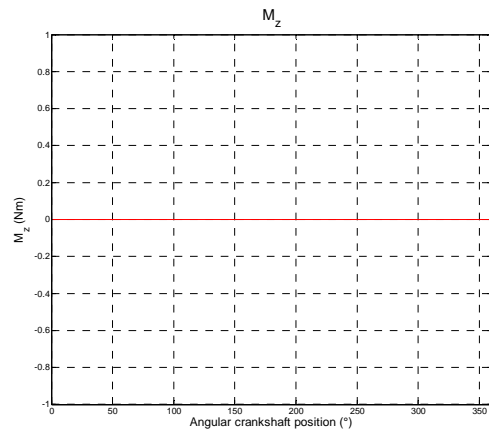
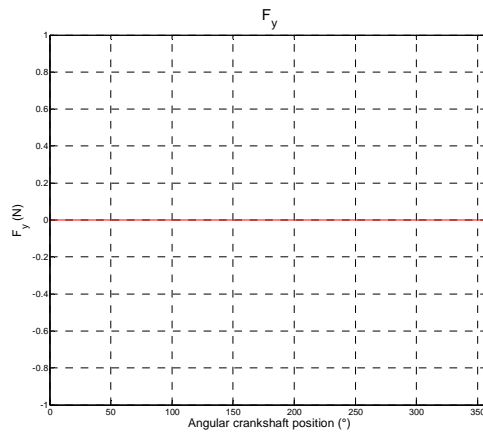
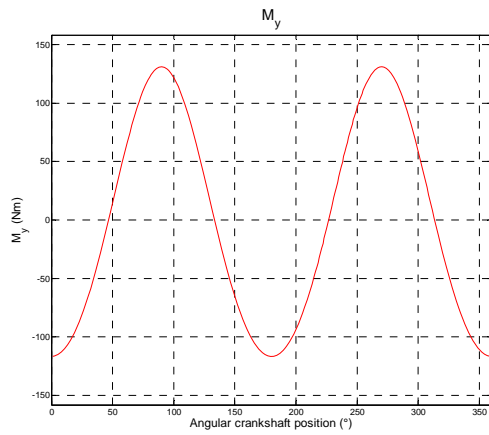
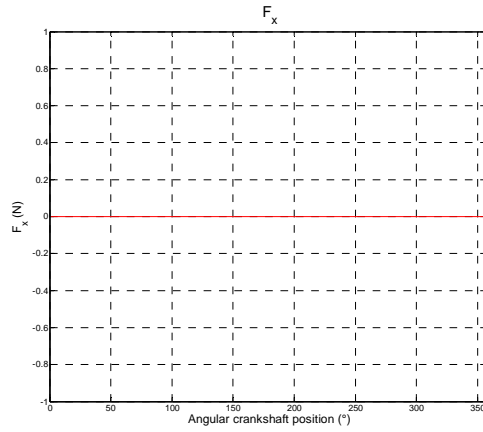
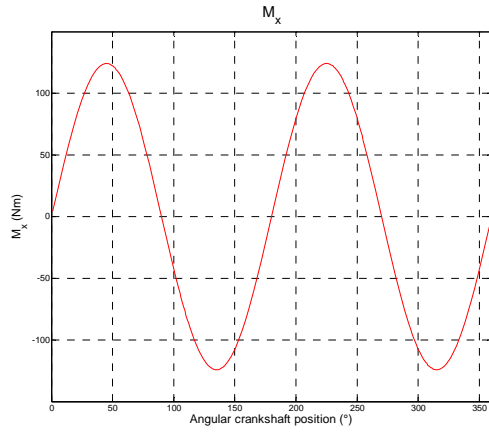
## In-phase boxer engine with one first order balance shaft and optimized crankshaft



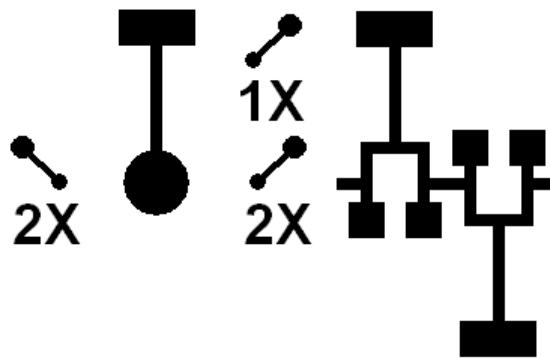
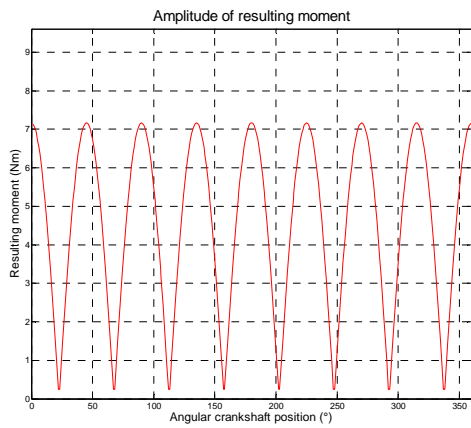
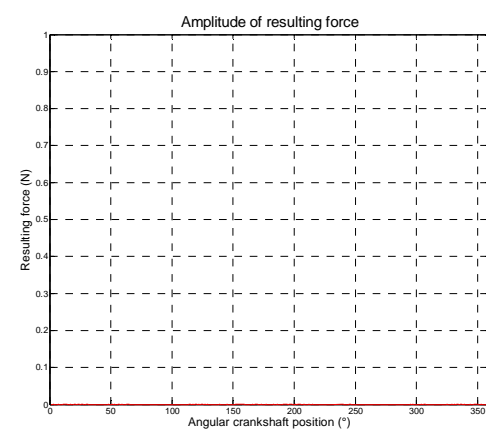
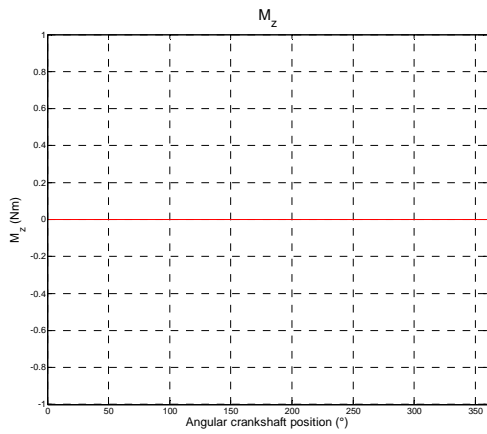
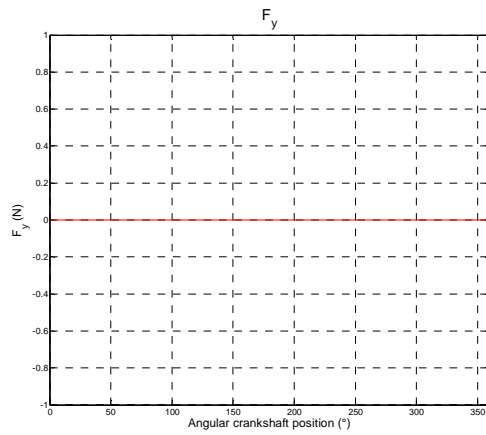
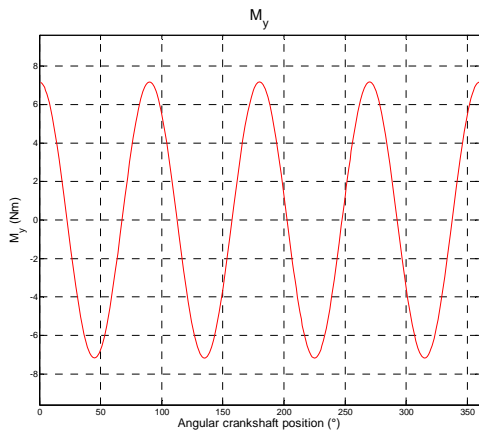
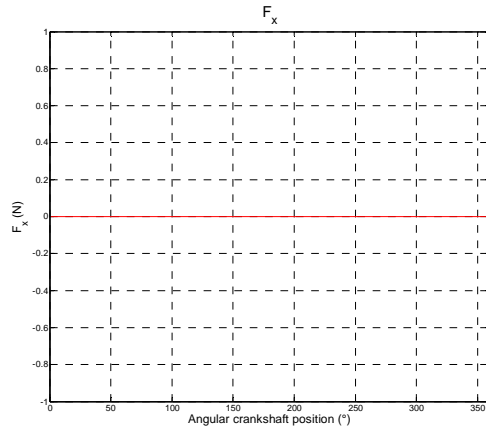
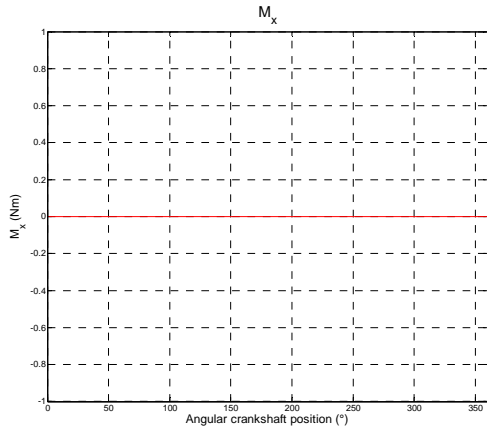
# In-phase boxer engine with two second order balance shafts and optimized crankshaft



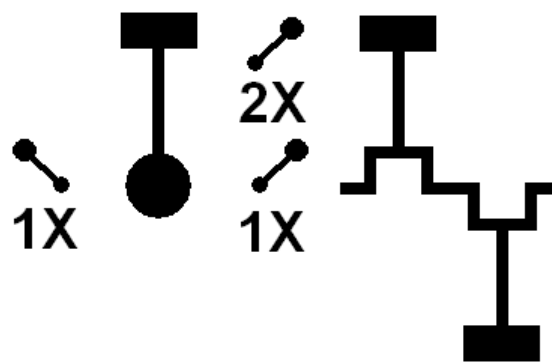
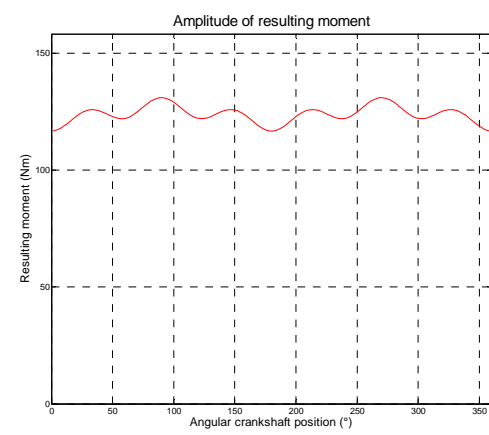
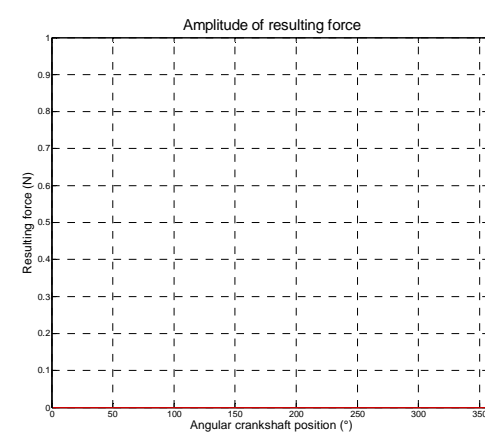
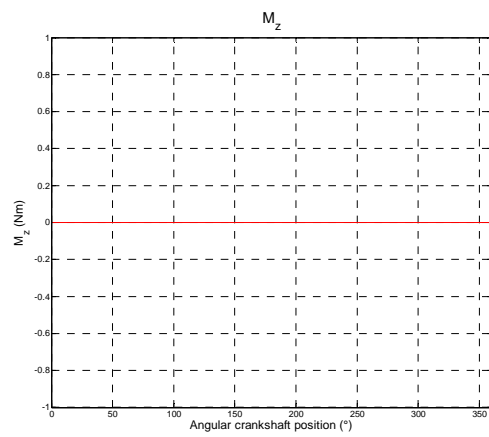
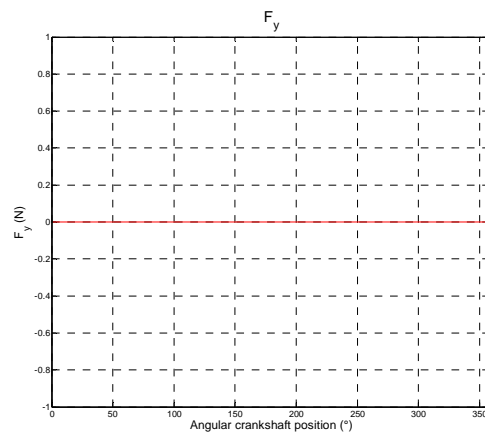
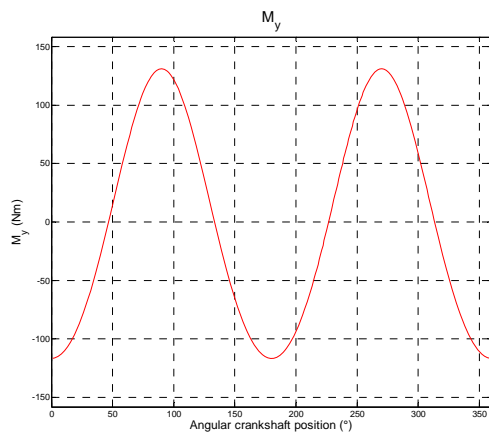
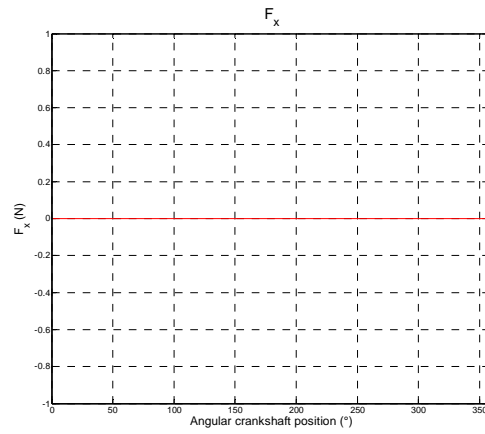
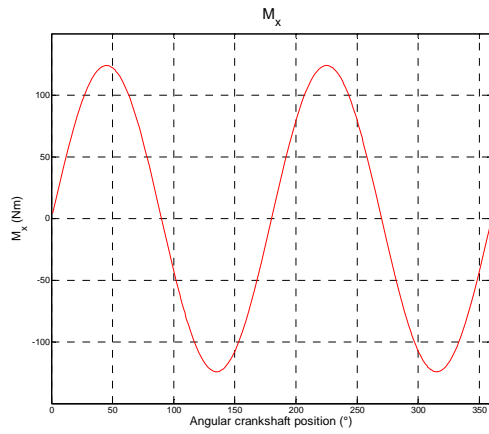
## In-phase boxer engine with one first and one second order balance shafts



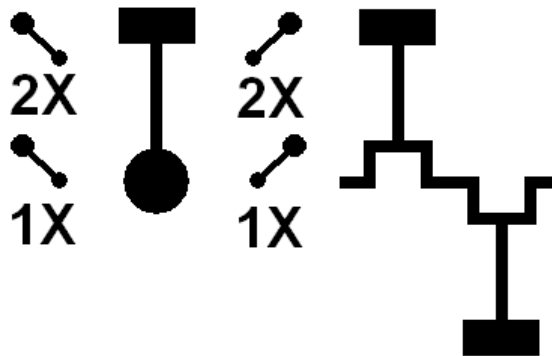
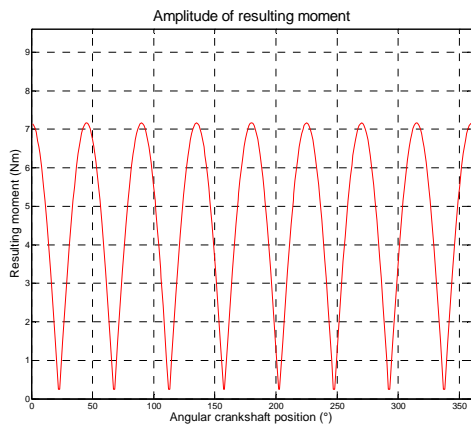
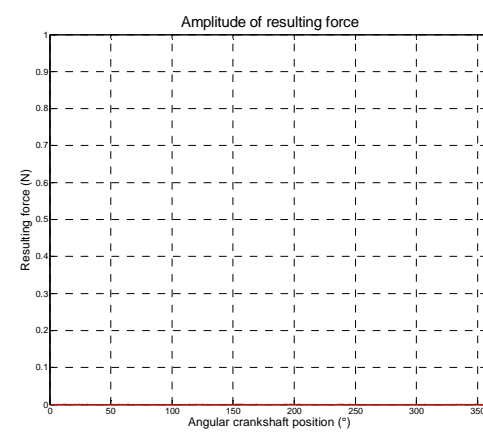
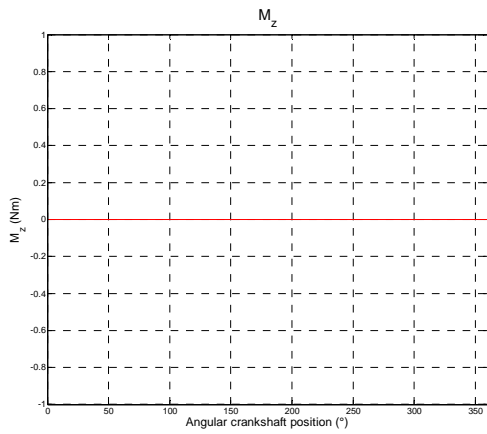
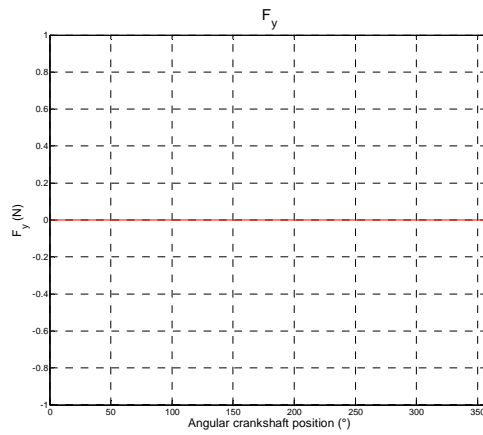
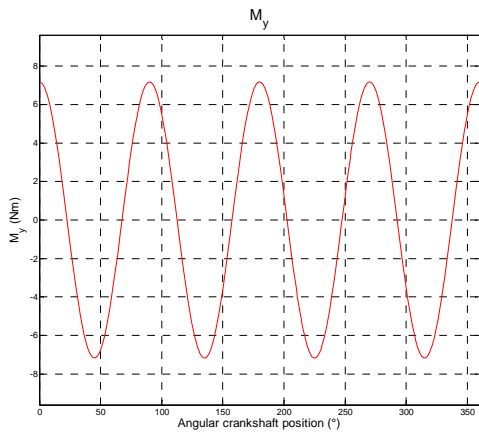
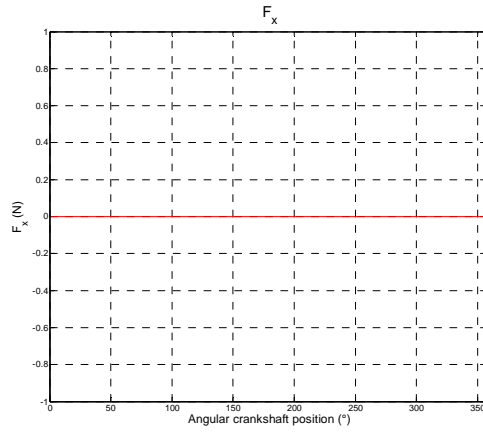
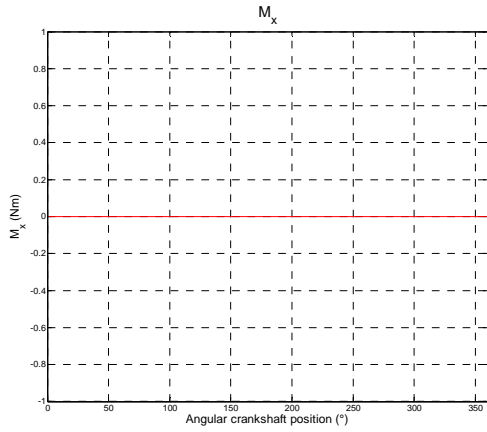
# In-phase boxer engine with one first and two second order balance shafts



## In-phase boxer engine with two first and one second order balance shafts



## In-phase boxer engine with two first and two second order balance shafts



## Appendix B: Graphics of forces and moments for the four-cylinder engine

This appendix gives the graphics representing the different forces and moments for the *longer* stroke four-cylinder engine described in the comparison section. The maximum values of forces and moments are given in the table 36. The four-cylinder engine is simulated in its basic configuration (no balance shaft and basic crankshaft).



