

# The sugar phosphotransferase system of *Streptomyces coelicolor* is regulated by the GntR-family regulator DasR and links *N*-acetylglucosamine metabolism to the control of development

Sébastien Rigali,<sup>1,2</sup> Harald Nothhaft,<sup>3</sup>  
Elke E. E. Noens,<sup>1,4</sup> Maximilian Schlicht,<sup>3</sup>  
Sévrine Colson,<sup>2</sup> Marisa Müller,<sup>3</sup> Bernard Joris,<sup>2</sup>  
Henk K. Koerten,<sup>4</sup> David A. Hopwood,<sup>5</sup>  
Fritz Titgemeyer<sup>3†</sup> and Giles P. van Wezel<sup>1\*</sup>

<sup>1</sup>Department of Biochemistry, Leiden Institute of Chemistry, Leiden University, PO Box 9502, 2300 RA Leiden, the Netherlands.

<sup>2</sup>Centre d'Ingénierie des Protéines, Université de Liège, Institut de Chimie B6a, B-4000, Liège, Belgium.

<sup>3</sup>Lehrstuhl für Mikrobiologie, Friedrich-Alexander-Universität Erlangen-Nürnberg, Staudtstrasse 5, 91058 Erlangen, Germany.

<sup>4</sup>Department of Molecular Cell Biology, Leiden University Medical Center, Leiden University, PO Box 9503, 2300 RA Leiden, the Netherlands.

<sup>5</sup>Department of Molecular Microbiology, John Innes Centre, Norwich Research Park, Colney, Norwich NR4 7UH, UK.

## Summary

Members of the soil-dwelling, sporulating prokaryotic genus *Streptomyces* are indispensable for the recycling of the most abundant polysaccharides on earth (cellulose and chitin), and produce a wide range of antibiotics and industrial enzymes. How do these organisms sense the nutritional state of the environment, and what controls the signal for the switch to antibiotic production and morphological development? Here we show that high extracellular concentrations of *N*-acetylglucosamine, the monomer of chitin, prevent *Streptomyces coelicolor* progressing beyond the vegetative state, and that this effect is absent in a mutant defective of *N*-acetylglucosamine transport. We provide evidence that the signal is transmitted through the GntR-family regulator DasR,

which controls the *N*-acetylglucosamine regulon, including the *pts* genes *ptsH*, *ptsI* and *crr* needed for uptake of *N*-acetylglucosamine. Deletion of *dasR* or the *pts* genes resulted in a bald phenotype. Binding of DasR to its target genes is abolished by glucosamine 6-phosphate, a central molecule in *N*-acetylglucosamine metabolism. Extracellular complementation experiments with many *bld* mutants showed that the *dasR* mutant is arrested at an early stage of the developmental programme, and does not fit in the previously described *bld* signalling cascade. Thus, for the first time we are able to directly link carbon (and nitrogen) metabolism to development, highlighting a novel type of metabolic regulator, which senses the nutritional state of the habitat, maintaining vegetative growth until changing circumstances trigger the switch to sporulation. Our work, and the model it suggests, provide new leads towards understanding how microorganisms time developmental commitment.

## Introduction

When sporulating bacteria are starved, sporulation remains suppressed until alternative responses prove inadequate (Stephens, 1998). Studies on *Bacillus* showed that prior to its decision to sporulate many alternatives are 'considered', including enhanced motility, antibiotic production to destroy competing microbes and perhaps lead to their consumption, and secretion of hydrolytic enzymes and competence factors for DNA uptake (Stephens, 1998). The decision to enter sporulation is not 'taken lightly', but once it is taken a complex spatial and temporal genetic programme is initiated (Chater, 2001; Dworkin and Losick, 2005; Willey *et al.*, 2006). While the sequence of events following this decision has been well documented, precious little is known as to how the nutritional signals are received and transmitted. The soil-dwelling, Gram-positive streptomycetes undergo complex morphological development (spore germination – vegetative mycelium – aerial mycelium – spores) quite similar to that of filamentous fungi

Accepted 3 July, 2006. \*For correspondence. E-mail g.wezel@chem.leidenuniv.nl; Tel. (+31) 71 5274310; Fax (+31) 71 5274340. †Additional corresponding author on sugar transport. Email: ftitgem@biologie.uni-erlangen.de

(Schauer *et al.*, 1988; Willey *et al.*, 1991). Pioneering work by Hopwood, Chater, Merrick and colleagues (reviewed in Chater, 1998; 2001) identified many genes essential for the onset of aerial development (*bld* for 'bald', reflecting the lack of the hairy aerial mycelium; Hopwood *et al.*, 1973; Merrick, 1976) or for specific stages of sporulation (*whi* for 'white', reflecting the lack of grey-pigmented spores; Hopwood *et al.*, 1970; Chater, 1972). The corresponding gene products were identified primarily by cloning the genes by complementation of the mutant phenotypes. More recently several new families of aerial development-specific proteins were discovered, including hydrophobin-like proteins that provide a water-repellent sheath around the aerial hyphae (Claessen *et al.*, 2003; Elliot *et al.*, 2003); the WhiB-like (Wbl) proteins, a family of small regulatory proteins specific to actinomycetes (Soliveri *et al.*, 2000); and the SsgA-like proteins, controlling specific stages in sporulation (Noens *et al.*, 2005).

Characterization of the sporulation proteins is facilitated by the discrete phenotypes of the *whi* mutants, as light and scanning electron microscopy readily reveal the step in sporulation blocked in the respective mutants (Flårdh *et al.*, 1999; Noens *et al.*, 2005). Such an unambiguous characterization is not possible for the *bld* mutants, which are limited to vegetative growth and lack such clear developmental blocks. However, *bld* mutants have a variety of pleiotropic defects that serve to distinguish some of them. They affect carbon regulation and antibiotic production, suggesting a role in sensing and responding to nutritional signals.

One important step towards the onset of aerial hyphal formation is production of SapB, a hydrophobic, lantibiotic-like molecule derived from the *ramS* gene product (Kodani *et al.*, 2004), which allows aerial hyphae to emerge into the air (Willey *et al.*, 1993; 2006). SapB production depends directly or indirectly on most of the known *bld* genes. Interestingly, 'complementation' has been observed for some *bld* mutants when grown close together. These relationships are unidirectional: one mutant acts as a secretor of and the other as a responder to putative extracellular molecules that restore aerial hyphal formation in the recipient, analogously to the way in which mutants blocked in the same antibiotic biosynthetic pathway act as secretors and converters of biosynthetic intermediates (Delic *et al.*, 1969). These experiments resulted in a proposed complementation hierarchy of many but not all *bld* mutants: *bldJ* → *bldK* → *bldA/H* → *bldG* → *bldC* → *bldD*, in which *bld* mutants to the right (secretors or donors) could induce development in *bld* mutants to the left (responders or recipients) (Kelemen and Buttner, 1998; Nodwell *et al.*, 1999; Willey *et al.*, 2006).

A key trigger of development, perhaps the ultimately relevant one, is reduced nutrient availability (Chater and

Horinouchi, 2003). The connection between the nutritional status of the environment and *Streptomyces* development is underlined by the medium dependence of most of the *bld* mutants, which sporulate on minimal medium with mannitol, but not with the more readily available glucose (Merrick, 1976; Pope *et al.*, 1996). While several lines of evidence suggest that catabolite control forms an important checkpoint towards the onset of development, mutants devoid of carbon catabolite control develop normally and respond normally to nutritional stimuli (Angell *et al.*, 1994). What then is the mechanism that monitors the environment's nutritional state and couples worsening prospects with a decision to enter the developmental programme?

The polysaccharides cellulose and chitin are the most abundant on earth, the former as the main component of plant cell walls, including those of forest trees, and the latter forming the exoskeletons of arthropods and the walls of fungal hyphae. Both compounds are therefore potentially crucial sources of carbon, and chitin also of nitrogen. As such they constitute an important marker for nutrient availability in soil-dwelling microorganisms, implying their possible involvement in developmental control. A developmental gene of particular interest for the link between carbon source-dependent gene regulation and development is *bldB*. *BldB* null mutants have a bald phenotype on all carbon sources and fail to produce aerial hyphae or antibiotics under any tested conditions (Pope *et al.*, 1998; Eccleston *et al.*, 2002). Furthermore, *bldB* mutants are defective in catabolite control, and do not fall in the hierarchy of extracellular complementation exhibited by many other *bld* mutants (Willey *et al.*, 1993; Pope *et al.*, 1996; Nodwell *et al.*, 1999).

We recently showed that the transcription factor DasR (deficient in aerial mycelium and spore formation) is most likely involved in control of the *Streptomyces coelicolor* sugar phosphotransferase system (PTS) (Rigali *et al.*, 2004), responsible for import of several carbon sources and notably *N*-acetylglucosamine (GlcNAc), the monomer of chitin (Nothaft *et al.*, 2003). Besides this possible relationship with carbon control (via the PTS), DasR is essential for development of *Streptomyces griseus*, and controls the *dasABC* transporter operon relating to glucose-dependent morphogenesis in *S. griseus* (Seo *et al.*, 2002).

Here we describe an in-depth investigation of the role of DasR in linking carbon availability to morphogenesis of streptomycetes. We demonstrate that the extracellular concentration of GlcNAc is a critical marker for the onset of sporulation in *S. coelicolor*, and that its signal is transmitted through DasR, which controls the GlcNAc regulon and development. The non-sporulating phenotype of the *dasR* mutant, and of the *pts* genes *ptsH*, *ptsI* and *crr* controlled by it, allows us for the first time to make a direct

link between primary metabolism and the *Streptomyces* developmental programme.

## Results

*dasR* is essential for development and falls outside the *bld* extracellular signalling cascade

In a recent communication we predicted binding of the *S. coelicolor* GntR-type regulator DasR to the consensus sequence ACTGGTCTAGACCACT, located upstream of the *pts* genes *ptsH*, *ptsI* and *crr*, which encode the general phosphotransferases HPr, enzyme I (EI) and enzyme IIA<sup>Crr</sup> respectively (Rigali *et al.*, 2004). Close inspection of the promoter regions revealed a possible DasR binding site upstream of many GlcNAc-related genes, including those encoding the chitinolytic system for degradation of the GlcNAc polymer chitin to chitobiose (GlcNAc<sub>2</sub>) and GlcNAc, and genes for transport and metabolism of GlcNAc and GlcNAc<sub>2</sub> (Fig. 1).

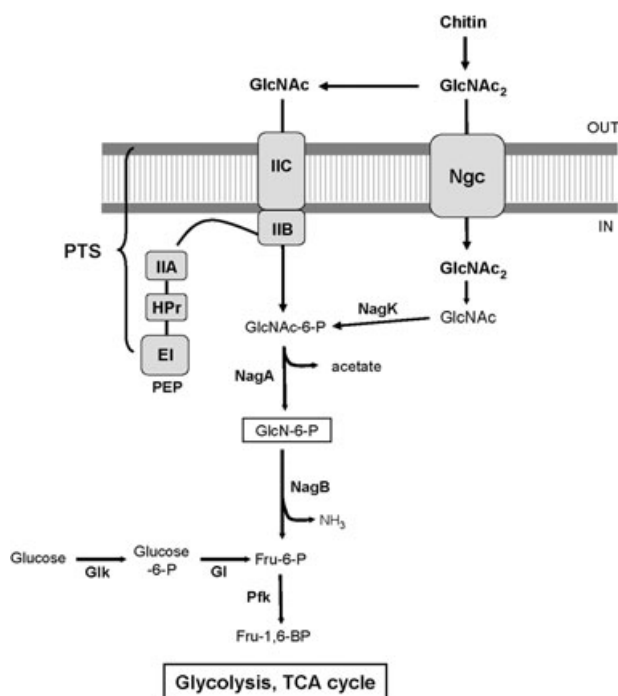

**Fig. 1.** *N*-acetylglucosamine (GlcNAc)-related enzymatic reactions. Extracellular chitin is hydrolysed to chitobiose (GlcNAc<sub>2</sub>) and on to GlcNAc, which are transported into the cell, where GlcNAc<sub>2</sub> is converted to GlcNAc. This is phosphorylated by NagK (GlcNAc kinase) to GlcNAc 6-phosphate (GlcNAc-6-P). NagA (GlcNAc-6-P deacetylase) deacetylates GlcNAc-6-P to glucosamine 6-phosphate (GlcN-6-P), which occupies a central position among nitrogen metabolism, the trichloroacetic acid (TCA) cycle, peptidoglycan precursor synthesis and glycolysis via NagB (GlcN-6-P isomerase), converting GlcN-6-P to fructose 6-phosphate (Fru-6-P). This scheme highlights the central position of GlcN-6-P, the effector molecule of the DasR regulon. The connected pathways can be retrieved from the KEGG database (<http://www.genome.ad.jp/kegg/pathway.html>).

To further investigate the function of DasR, we analysed the effect of deleting the *dasR* gene of the sequenced *S. coelicolor* derivative M145. We replaced almost the complete coding region (nt 14–635 out of 765) by the apramycin resistance cassette (*aacC4*). Of the many independent mutants that were obtained, three were checked by PCR, confirming that the expected gene replacement had occurred (not shown). The three strains had a highly similar phenotype, and one of these was selected and designated BAP29. Interestingly, the *dasR* mutant failed to produce aerial hyphae and spores on glucose-containing media [MM + glucose (Fig. 2A) and R2YE agar plates], and thus identifies a new *bld* gene of *S. coelicolor*. The *dasR* mutant showed medium-dependent development, as displayed by most *bld* mutants on MM + mannitol (Fig. 2A), but it failed to produce significant amounts of spores on soy flour mannitol (SFM) agar, and strongly overproduced actinorhodin on this medium (not shown). To verify that the mutation was solely due to the inactivation of *dasR*, we integrated a non-replicative vector harbouring *dasR* and its promoter region (nt positions –473/+954 relative to the start of *dasR*) into the genome. This fully restored development, producing aerial hyphae and spores (Fig. 2B), underlining that the morphological defects of BAP29 were indeed due to the inactivation of the *dasR* gene.

In contrast to sporulation (*whi*) mutants, which have clear morphological defects pinpointing the position in the sporulation programme where the wild-type gene is active, *bld* mutants lack clear morphological identifiers. To discover where *dasR* is positioned in the cascade of events controlling early development (reviewed by Willey *et al.*, 2006), we streaked BAP29 close to the best-characterized *bld* mutants, and as controls the *whiG* mutant which forms aerial hyphae but not spores (Chater *et al.*, 1989), as well as the wild-type strain M145. This complementation experiment revealed that the *bldA*, *bldB*, *bldC* and *bldF* mutants, as well as the control strains M145 and *whiG71*, could induce aerial hyphal formation in BAP29, while such extracellular complementation was not observed for the *bldD*, *bldG*, *bldH*, *bldJ* or *bldK* mutants (Fig. 3). However, the *dasR* mutant did not fall into the signalling ‘pathway’: it failed to restore development to any of the *bld* mutants analysed (suggesting that it would be earliest in the *bld* hierarchy), but the *bldD* mutant, considered as the last in the cascade, failed to restore development to the *dasR* mutant, while several of the earlier *bld* mutants did so. All *bld* mutants, except *bldK*, induced production of pigmented antibiotics in the *dasR* mutant, suggesting that the unknown peptide molecule transported by the BldK oligopeptide permease (Nodwell *et al.*, 1996) is required for onset of antibiotic production by the *dasR* mutant.

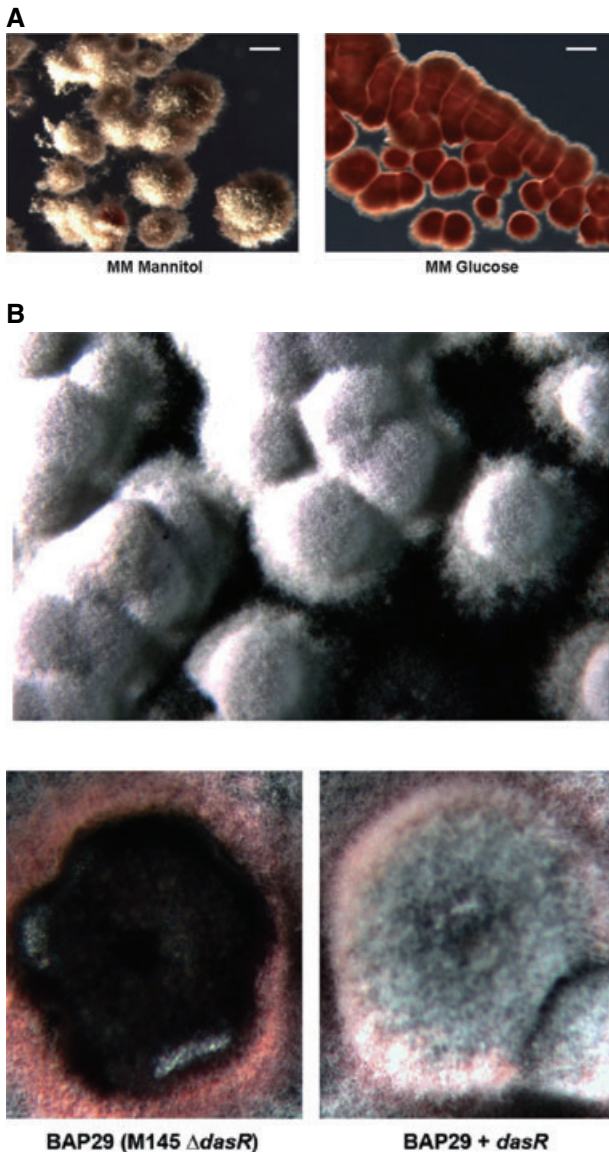

**Fig. 2.** Phenotype of the *dasR* mutant and complementation *in trans*.

A. Colonies were grown on MM + mannitol or MM + glucose. On these minimal media the *dasR* mutant displays the conditional bald phenotype typical of *bld* mutants, namely development on mannitol and vegetative arrest (Bld) on glucose. Bar = 2 mm.

B. Complementation of the *dasR* mutant. BAP29 was fully complemented by insertion of a plasmid harbouring the *dasR* gene and its promoter region into its genome. Top: full development of the complemented BAP29 complemented with wild-type *dasR* (SFM agar plates); bottom: close-ups of BAP29 (left) and BAP29 complemented with *dasR* (right) grown on R2YE agar plates. Both colonies had a diameter of 5 mm.

#### High-resolution analysis of the *dasR* mutant by scanning electron microscopy and transmission

Repeated plating and viable spore counts showed that the *dasR* mutant made very few spores on SFM agar, and none on R2YE agar. Closer inspection by cryo-scanning

electron microscopy (cryo-SEM) revealed strictly vegetative growth (Bld phenotype) on R2YE. On SFM, abundant aerial hyphae were produced, which collapsed readily during sample preparation (Fig. 4A), and viable spore counts of the mutant were about three orders of magnitude lower than those of spore preparations from the parent M145.

Analysis at high resolution by transmission electron microscopy (TEM) of thin sections of M145 and BAP29 grown on SFM agar showed that around 30% of the few spores eventually produced by the *dasR* mutant differed from the wild type in having voids of various sizes beneath the spore wall (Fig. 4B; arrows), suggesting extensive detachment of the cytoplasmic membrane from the wall. Additionally, spore morphologies were significantly more heterogeneous; while wild-type spores are typically around 1  $\mu$ m long, the *dasR* mutant showed an unusually marked variation in spore length (0.5–1.4  $\mu$ m), but with a uniform width of 0.8  $\mu$ m. Also, many mutant spores lacked the typical thick spore wall, having a wall thickness similar to that of aerial hyphae.

#### Expression of the PTS is constitutive in the *dasR* mutant

As many of the predicted DasR targets are involved in GlcNAc transport and metabolism, we analysed the effects of the *dasR* mutation on sugar import. Previously, we suggested that the PTS system might be a direct target for control by DasR (Rigali *et al.*, 2004). To substantiate this experimentally, we performed transport assays of GlcNAc: interestingly, PTS-mediated internalization of GlcNAc became constitutive in the *dasR* mutant, while in the parent uptake was strongly induced by GlcNAc (Fig. 5A). The difference was reflected in constitutive protein levels of the sugar phosphotransferases HPr and IIA<sup>Crr</sup> in BAP29, which activate the GlcNAc-specific permease (IIBC<sup>GlcNAc</sup>) through phosphorylation (Fig. 5B).

To further characterize the role of DasR in controlling *pts* gene expression, we analysed mRNA from liquid-grown cultures of the *dasR* knockout mutant. Typically, *pts* gene expression is low in cultures grown without GlcNAc, and induced by the presence of this important metabolite. Hence, an induction experiment was performed in which M145 and BAP29 were grown in liquid minimal medium with glycerol as sole carbon source, and at an OD<sub>550</sub> of 0.7 GlcNAc was added to 20 mM (0.5% w/v). RNA samples were taken immediately before addition of GlcNAc (0 min), and 15 min, 30 min and 60 min after induction. Reverse transcription polymerase chain reaction (RT-PCR) analysis of the RNA was performed, using oligonucleotide pairs for the GlcNAc-related genes *ptsH*, *ptsI*, *crr*, *malX2* and *nagB*



**Fig. 3.** Extracellular complementation between *bld* mutants. The *dasR* mutant BAP29 was streaked on R2YE agar plates close to each *bld* mutant, *bldA39* (J1700), *bldB43* (J701), *bldC18* (J660), *bldD53* (J774), *bldF* (161), *bldG103* (C103), *bldH109* (C109), *bldJ261* (HU61) or *bldK::aadA* (NS17), to the *whiG* mutant (C17), or to the parent M145. All *bld* mutants and BAP29 had a strictly bald phenotype when streaked alone on R2YE agar (Fig. S3 in *Supplementary material*). Note that BAP29 failed to act as a secretor to any of the *bld* mutants, but acted as a responder to *bldA*, *bldB*, *bldC* and *bldF*, as well as to *whiG* and M145. All complementations were carried out repeatedly, to exclude effects caused by possible fluctuations in medium composition, and gave highly reproducible effects.

[encoding HPr, EI, and components IIA<sup>Crr</sup> and IIB<sup>GlcNAc</sup>, and the metabolic enzyme glucosamine 6-phosphate (GlcN-6-P) isomerase respectively] (Fig. 1). In the absence of GlcNAc ( $t = 0$ ), expression of *pts* and *nag* was high in the *dasR* mutant relative to the parental strain, strongly suggesting that these genes are repressed by DasR (Fig. 5C). However, after addition of GlcNAc, *pts* and *nag* expression was induced in the parental strain, and steady-state RNA levels were very similar between mutant and parent. Expectedly, expression of 16S rRNA was the same in M145 and BAP29. Hence we conclude that DasR is a repressor of the *pts* and *nagB* genes, and its repressing activity is strongly reduced by addition of GlcNAc.

Direct binding of DasR to the *pts* and *nag* genes was established by electromobility shift assays using purified (His)<sub>6</sub>-tagged DasR and double-stranded oligonucleotides encompassing the predicted DasR binding sites of the

respective promoter regions. Direct binding of DasR was established for *nagA*, *nagB*, *crr-ptsI*, *ptsH*, *nagE1* and *nagE2* (Fig. 8 and data not shown).

#### *DasR and the control of development*

In a previous study, the *pts* mutants  $\Delta ptsH$  (BAP1),  $\Delta crr$  (BAP2) and  $\Delta ptsI$  (BAP3) were subjected to extensive biochemical analysis, but only brief morphogenetic characterization was performed on SFM agar plates, where all *pts* mutants formed aerial hyphae and showed light grey pigmentation (Nothaft *et al.*, 2003). Considering the possible relevance of the PTS in controlling development, we subjected the three mutants to intensive morphological analysis. Surprisingly, on R2YE all three *pts* mutants showed complete vegetative arrest and were therefore classified as novel *bld* mutants. In agreement with their functional relationships as members of the PTS, the

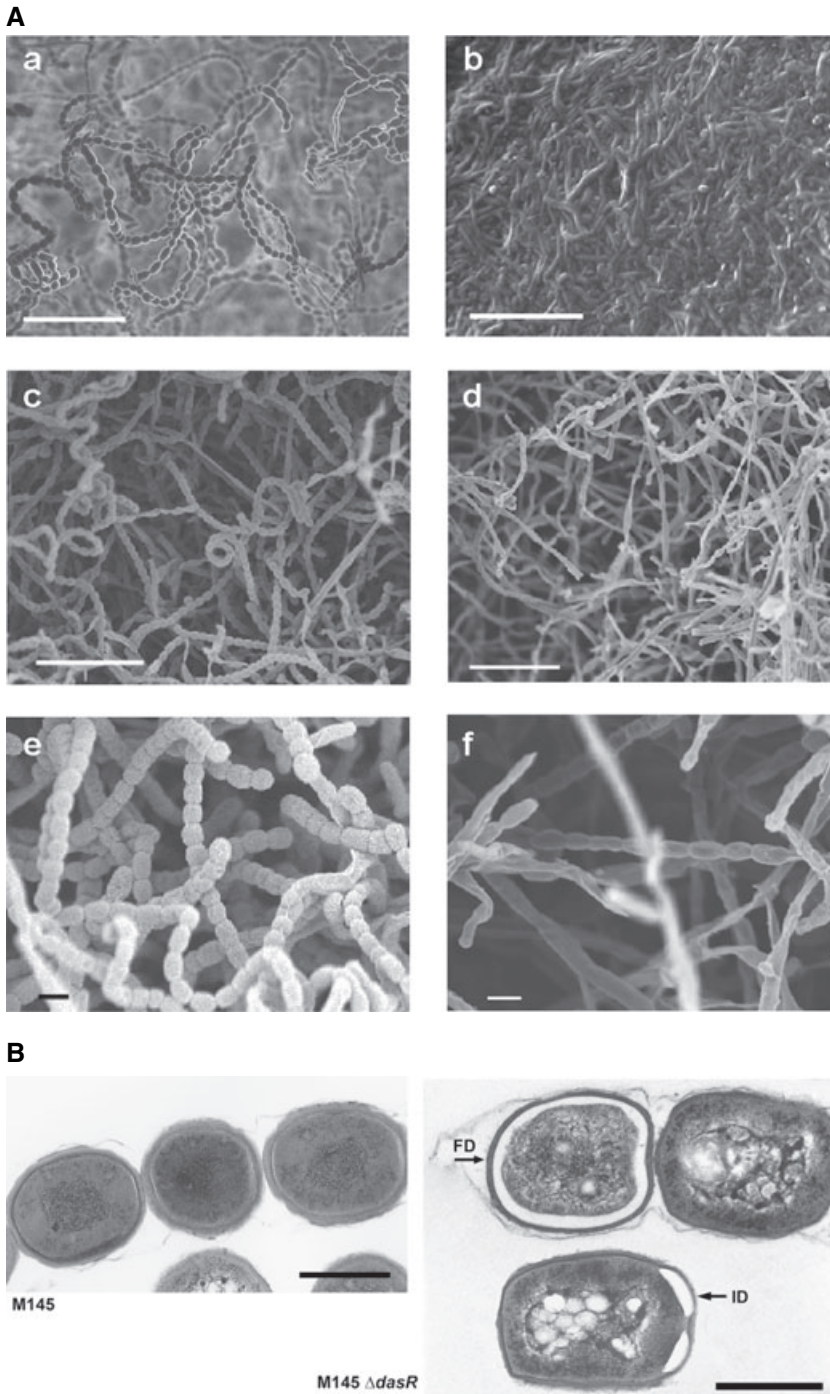

**Fig. 4.** Phenotype of the *dasR* knockout mutant.

A. Scanning electron micrographs of *S. coelicolor* M145 (a, c and e) and the *dasR* mutant BAP29 (b, d and f) grown on R2YE agar (a and b) and on SFM agar (c–f). The close-ups show aberrant spores of the DasR mutant (f) compared with the wild type (e). Bars: a–d, 10  $\mu$ m; e and f, 1  $\mu$ m.

B. Transmission electron micrographs of spores of M145 (left) and BAP29 (right). Arrows indicate voids between the cell wall and the membrane. FD, full detachment; ID, incomplete detachment. Bar = 500 nm.

mutants failed to complement each other extracellularly (Fig. 6). On the mannitol-containing media SFM and MM + mannitol, all three *pts* mutants produced aerial hyphae after prolonged incubation (8–10 days), a phenomenon typical of most *bld* mutants. Finally, analysis of the mutants by fluorescence microscopy confirmed the developmental defects, but in the few aerial hyphae that were produced the DNA had segregated normally (not shown).

#### *GlcNAc blocks development of S. coelicolor*

The non-sporulating (*Bld*) phenotype of the *dasR*, *ptsH*, *ptsI* and *crr* mutants suggested an association between nutrient utilization – specifically of GlcNAc – and development. To test this correlation, we plated M145 on minimal medium and R2YE agar plates containing various carbon sources, including arabinose, cellobiose, fructose, galactose, glucose, glycerol, mannitol, casamino acids,

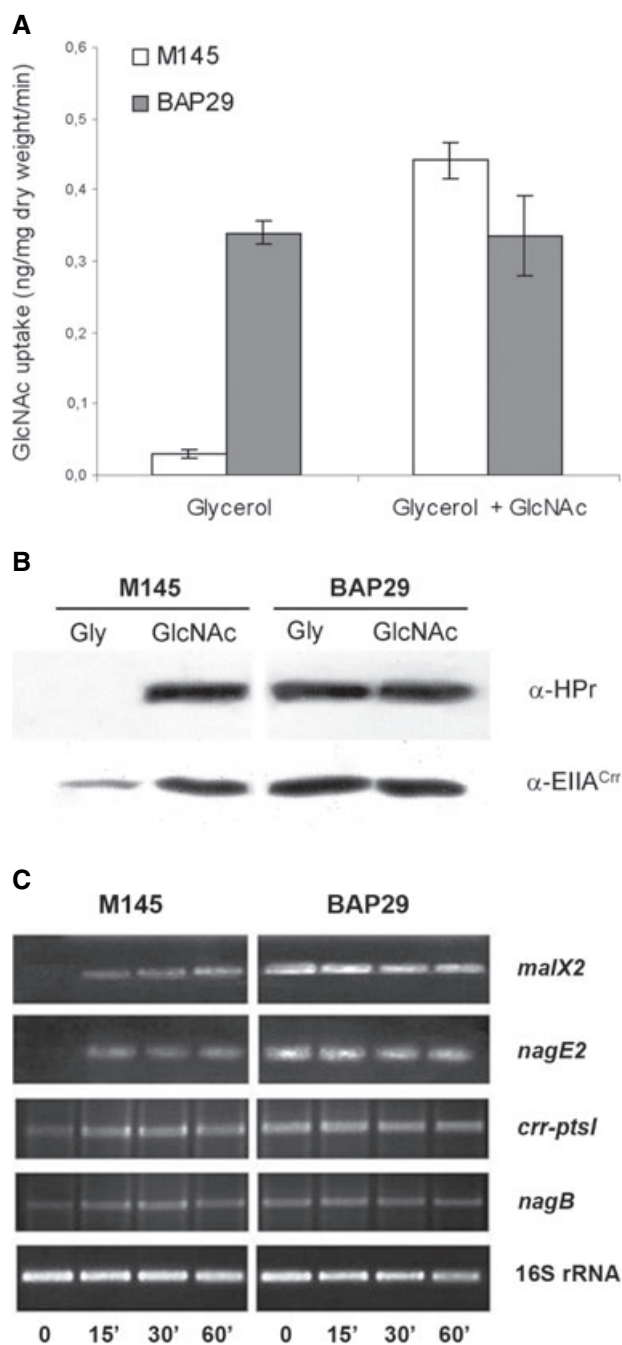

**Fig. 5.** DasR represses the *pts* genes for *N*-acetylglucosamine (GlcNAc) transport and metabolism.

**A.** Effect of deletion of *dasR* on uptake of GlcNAc. Left, uptake in glycerol-grown cultures; right, uptake in cultures grown in glycerol and inducer (GlcNAc); note that expression was constitutive in BAP29.

**B.** Western blot analysis of HPr (top) and IIA<sup>Crr</sup> (bottom), showing that inducibility of these PTS proteins is also controlled by DasR. Culture conditions were the same as in (A).

**C.** Transcriptional analysis of *crr* (for IIA<sup>Crr</sup>), *nagE2* (for IIC<sup>GlcNAc</sup>), *malX2* (for IIB<sup>GlcNAc</sup>) and *nagB* by semiquantitative RT-PCR; time (min) of sample collection either before (0) or after addition of GlcNAc to exponentially growing MM + glycerol cultures. 16S rRNA was used as the control.

glutamate and GlcNAc. The media were buffered to pH 7.2. Surprisingly, GlcNAc blocked development, resulting in bald colonies (Fig. 7A), while the other carbon sources had no effect (not shown). The 'GlcNAc effect' was particularly apparent at concentrations above 20 mM (0.5% w/v), although some inhibition of development was already observed around 5 mM GlcNAc (~0.1% w/v). Analysing colonies of M145 and its *dasR* mutant BAP29 at higher magnification by stereomicroscopy confirmed the almost complete absence of aerial hyphae in M145, although closer inspection by cryo-SEM of sections of the colonies revealed a few aerial hyphae (Fig. 7B).

GlcNAc induced radial outgrowth of the colony in BAP29, giving the colonies a wrinkled appearance, somewhat similar to the effect of overexpressing DasA, a known DasR target in *S. griseus* (Seo *et al.*, 2002), although the latter was observed on glucose-containing media. The *dasR* mutant colonies were nearly flat and failed to produce any aerial hyphae, as confirmed by high-resolution stereomicroscopy (600 $\times$  magnification, not shown). Interestingly, after prolonged incubation of M145 on plates with GlcNAc, especially at 20–50 mM, the colonies started to develop, most likely because of a gradual decrease in the local GlcNAc concentration.

To ascertain that the morphological effect of GlcNAc was indeed due to transport and/or metabolism of the compound, we tested the effect of GlcNAc on development of a mutant (BAP5) deleted for the GlcNAc-specific transporter gene *nagE2* (SCO2907). In *S. coelicolor* GlcNAc is internalized via the NagE2 (IIC<sup>GlcNAc</sup>) component of the PTS (Nothhaft *et al.*, 2003; H. Nothhaft and F. Titgemeyer, unpublished data), while in *Streptomyces olivaceoviridis* GlcNAc is transported via NagE2, but its internalization is also facilitated by the NgcEFG transporter (Wang *et al.*, 2002; Xiao *et al.*, 2002). As a control we also used BAP4, a mutant deleted for *nagE1* (SCO2906), homologous to *nagE2* but not involved in GlcNAc internalization (H. Nothhaft and F. Titgemeyer, unpublished data), as well as a *nagE1 nagE2* double mutant (BAP6). All three mutants were streaked on R2YE agar plates with or without GlcNAc (1% w/v). In the absence of *nagE2* (or *nagE2* and *nagE1*) addition of GlcNAc had no effect on development, while in the *nagE1* mutant and in *S. coelicolor* M145, which properly internalize GlcNAc, addition of GlcNAc resulted in their vegetative arrest (Fig. S1 in *Supplementary material*). This confirmed that GlcNAc inhibits the development of *S. coelicolor* only if it is properly utilized.

#### *GlcN-6-P* modulates the activity of DasR

Could there be a direct relationship between the developmental arrest caused by GlcNAc and by deletion of *dasR*? GntR-type regulators are characterized by an N-terminal helix–turn–helix (HTH) DNA-binding motif and a C-terminal

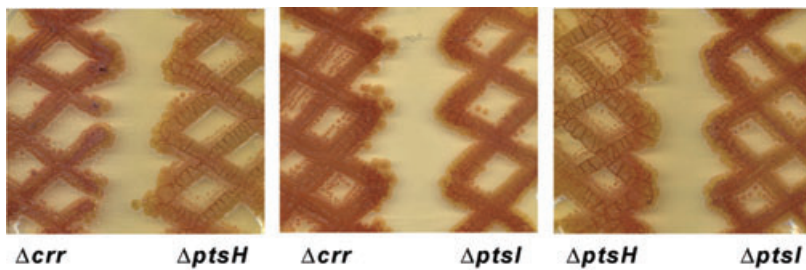

**Fig. 6.** Phenotype of the *pts* mutants on R2YE and SFM agar. Strains BAP1 (M145 *ptsH::aacC4*), BAP2 (M145 *crr::aacC4*) and BAP3 (M145 *ptsI::aacC4*) were grown for 7 days on R2YE agar, and all three PTS mutants showed complete vegetative arrest (Bld phenotype). Note that the mutants fail to complement each other.

effector-binding domain (Rigali *et al.*, 2002; 2004). On binding of the effector molecule the protein dissociates from the target site. A pivotal question is therefore: what is the effector molecule that modulates DasR? As described above, many of the DasR targets relate to GlcNAc and, following its internalization, it is metabolized in several steps to fructose 6-phosphate (Fru-6-P) (feeding into glycolysis) while the ammonia is coupled to glutamate to form glutamine (Gln) (for amino acid biosynthesis). We tested several intermediates of GlcNAc metabolism for their ability to act as effector molecules, namely GlcNAc 6-phosphate (GlcNAc-6-P), GlcN-6-P, Gln and Fru-6-P, as well as GlcNAc itself. The ability of these compounds to interfere with binding of DasR to the *nagB* and *crr* promoters was tested in a binding interference experiment. Excitingly, while addition of GlcNAc (Fig. 8, left), Gln or GlcNAc-6-P (not shown) had no effect on the DNA binding activity of DasR, increasing concentrations of GlcN-6-P specifically inhibited binding of DasR to the *nagB* and *crr* promoters (Fig. 8, middle and right). Thus, we conclude that GlcN-6-P, which is central to glucosamine-related metabolism, is an important effector of DasR regulatory activity.

## Discussion

The availability of nutrients in the soil is pivotal to the choice of streptomycetes between continuing vegetative growth and, in adverse conditions, switching on the morphogenetic programme leading to production of stress-resistant spores. We discovered that one such nutritional signal is the concentration of GlcNAc, as at concentrations above 10 mM it prevents the aerial mycelium from forming, locking the organism in the vegetative state. We characterized four newly identified *S. coelicolor* *bld* genes that relate to GlcNAc, and are candidates to link carbon control to morphogenesis, namely the *gntR*-type transcriptional regulatory gene *dasR* and the *pts* genes *ptsH* (for HPr), *ptsI* (for EI) and *crr* (for Enzyme IIA<sup>Crr</sup>), all of which are directly repressed by DasR. In fact, DasR most likely controls all GlcNAc-related genes (transport, metabolism and degradation of chitin, a polymer of GlcNAc), and its regulon may extend much further to include sugar transport, amino acid metabolism and peptidoglycan degradation (our unpublished data and below). Such a relationship with pepti-

doglycan maintenance is already suggested from the morphology of the *dasR* mutant spores, which typically show detachment of the cytoplasmic membrane from the surrounding spore envelope. In all of our previous TEM analyses, we never came across this appearance.

Under most conditions, the *dasR* and *pts* mutants have a Bld phenotype. *bld* mutants lack the morphological identifiers that discriminate the sporulation mutants (*whi*, *ssg*, *fts*, etc.), and are therefore characterized by their ability to extracellularly complement the development and/or antibiotic production of other early developmental mutants, allowing categorization of *bld* genes into the early developmental programme. These complementation experiments showed that sporulation was induced in the *dasR* mutant by growing it adjacent to the parental strain M145 and to the *bldA*, *bldB*, *bldC*, *bldF* and *whiG* mutants, while proximity of the *bldD*, *bldG*, *bldJ* and *bldK* mutants had (almost) no positive effect. The observation that, for example, the *bldA* mutant restores development to the *dasR* mutant but the *bldD* mutant does not indicates that the *dasR* deletion mutant does not fit properly into the published cascade *bldJ* → *bldK* → *bldA/H* → *bldG* → *bldC* → *bldD*, reinforced by the *dasR* mutant failing to restore development to any of the *bld* mutants tested. Hence, it appears that none of the signals eventually leading to initiation of aerial growth is established in the *dasR* mutant BAP29. It was shown previously that pH plays an important role in the control of development: *bldA*, *bldB*, *bldG*, *bldH* and *bldJ* mutants acidified R2YE plates to around pH 5, while *bldD*, *bldF*, *bldK* mutants and the wild-type strain did not (the pH remained around 7) (Viollier *et al.*, 2001). However, we found no correlation between this pH effect and the ability of *bld* mutants to complement the *dasR* mutant, as the ability (or inability) of *bld* mutants to extracellularly complement the *dasR* mutant was independent of acidification of the growth medium. Another easily monitored parameter is the production of pigmented antibiotics. Lack of antibiotic production characterizes most *bld* mutants, and particularly those arrested earlier in the developmental programme. When grown separately (i.e. not in the vicinity of the *dasR* mutant), only *bldF* and *bldK* mutants were pigmented on R2YE. Our complementation experiments showed that the *dasR* mutant induces antibiotic production in the *bldA*, *bldB*, *bldD* and *bldH* mutants.



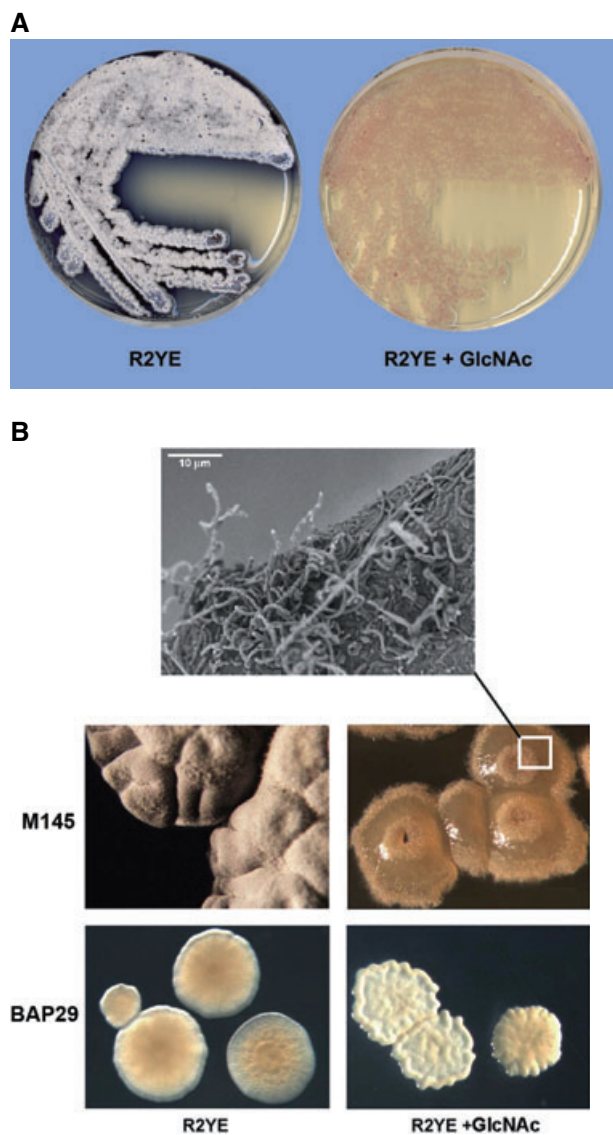

**Fig. 7.** GlcNAc inhibits *Streptomyces* development. **A.** Effect of GlcNAc on development and antibiotic production by *S. coelicolor* M145. While M145 develops normally on R2YE, concentrations of GlcNAc above 10 mM (20 mM is shown) inhibit development and antibiotic production – particularly that of the blue-pigmented actinorhodin. **B.** *Streptomyces coelicolor* M145 and BAP29 grown on MM + mannitol medium with or without GlcNAc. Again, development of *S. coelicolor* M145 is inhibited by GlcNAc (20 mM). Interestingly, the *dasR* mutant produced almost completely flat and smooth colonies, suggesting a strong effect on colony morphology, and presumably collapsed hyphae. Addition of GlcNAc caused a ragged appearance of the colony edges, suggesting a correlation between nutrients and morphology. The off-white appearance of the colonies is due to a lighting artefact from the swan neck lights on the smooth colonies; the absence of aerial hyphae was confirmed by higher magnification (600 $\times$  using a compound lens) and by phase-contrast microscopy (not shown).

Hence, in respect to antibiotic production, the *dasR* mutant acts as a secretor to many *bld* mutants, irrespective of their position in the *bld* complementation hierarchy.

To establish the relationship between the *dasR* and *pts* mutants, a similar complementation experiment to that described above revealed that the *dasR* mutant failed to act as a complementation secretor to the *pts* mutants, and the *pts* mutants could hardly restore development to the *dasR* mutant (Fig. S2 in *Supplementary material*). Interestingly, the *nagE2* GlcNAc transporter mutant – which fails to utilize GlcNAc – could restore full development (aerial hyphae that differentiated into mature spores) to the *dasR* mutant, while the *ptsI*, *ptsH* and *crr* mutants could not. This reinforces the conclusion that the bald phenotype of the mutants does not directly reflect the lack of utilization of GlcNAc (see below). This also suggests that the general PTS phosphotransferases (EI, HPr, IIA<sup>Crr</sup>), which are all unable to promote the uptake of GlcNAc, must have a regulatory function in the signalling of development.

An obvious and crucial question is: why do the *dasR*, *ptsH*, *crr* and *ptsI* mutants have a bald phenotype on rich media? For DasR, there are two direct links to developmental control. One obvious target is the GlcNAc PTS itself, which is essential for the onset of development, and all components are directly controlled and repressed by DasR (shown by binding of purified DasR to the *pts* promoter regions, by RT-PCR, by transport assays and by Western analysis). An apparent contradiction is that in the absence of DasR the PTS is upregulated (i.e. constitutively expressed), while in the *pts* mutants the PTS system is non-functional; however, overexpression of DasR mimics the effect of deleting the gene, producing a Bld phenotype and overproduction of actinorhodin on almost all media except R2YE (not shown). Thus, strong fluctuations in expression of this GntR-family regulator seem to upset the developmental programme. Similar observations were made for the cell division gene *ftsZ*, where strains overexpressing FtsZ had a similar phenotype to that of the *ftsZ* null mutant (aerial hyphae, but no septa and hence no spores; McCormick *et al.*, 1994; van Wezel *et al.*, 2000a), and for the cell division-related gene *ssgA* (van Wezel *et al.*, 2000b). Thus, balanced expression of important cellular components is crucial for their proper functioning.

Besides the PTS, there is a second link between DasR and development. The wrinkled phenotype of the *dasR* mutant is reminiscent of that of *S. griseus* overexpressing *dasA*, encoding the substrate-binding moiety of the DasABC transporter that internalizes an unknown substrate and whose transcription is repressed by the adjacent DasR (Seo *et al.*, 2002). In *S. griseus*, both *dasR* and *dasA* mutants have a Bld phenotype, although ectopic spores are produced by the *dasR* mutant. Unfortunately, in contrast to the well-studied *pts* genes, the biochemical

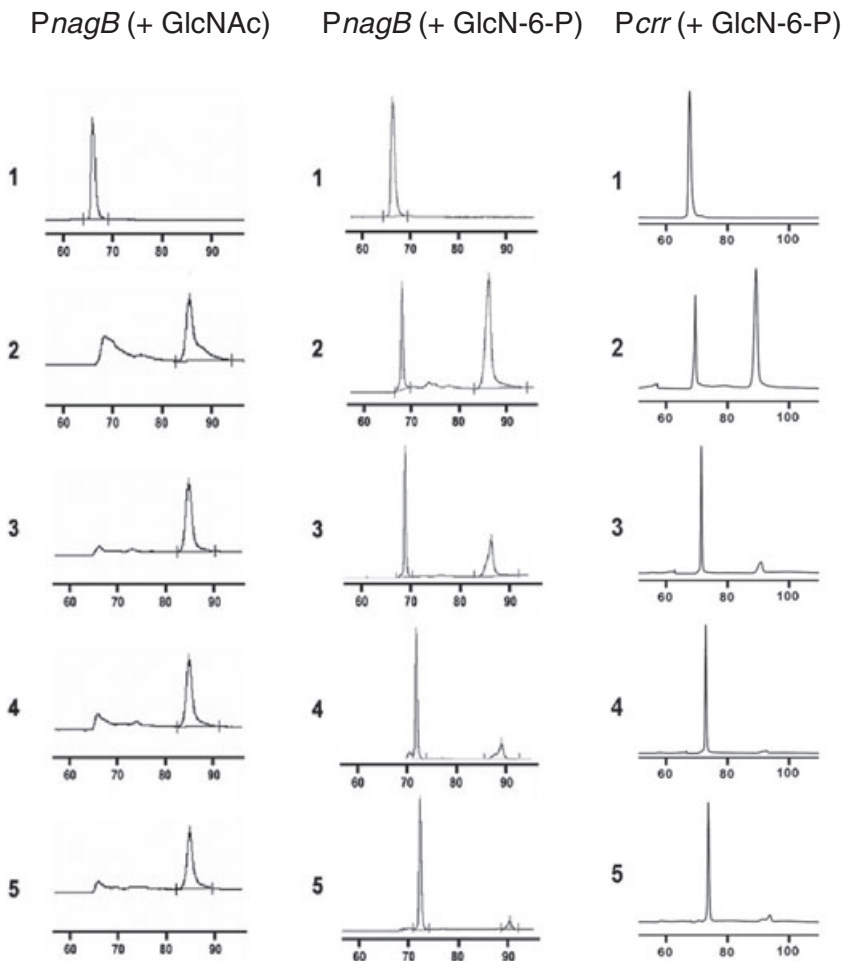

**Fig. 8.** DNA binding by DasR is inhibited by glucosamine 6-phosphate (GlcN-6-P). The figure shows EMSAs of DasR binding to probes corresponding to the upstream regions of *nagB* (left and middle) and of *crr* (right). EMSAs were performed with 10 nM fluorescent probes 3  $\mu$ M purified DasR, and 500-fold excess of non-specific DNA. In all panels, plot 1 shows the control experiment (no DasR added), and plots 2–5 show EMSAs in the presence of DasR and 50, 100, 150 and 200 mM GlcNAc (left panel) and GlcN-6-P (middle and right); note release of DasR from the *dre* site by GlcN-6-P but not by GlcNAc.

function of the *dasABC* genes is unknown, and how they might affect morphogenesis in *S. coelicolor* needs to be elucidated.

The question why the *pts* mutants are bald is perhaps more straightforward than for *dasR*, in light of the role of the PTS in glucose (or any other PTS substrate) transport and phosphorylation in *Escherichia coli*. In the presence of glucose the PTS transfers the phosphate from phosphoenolpyruvate (PEP) to the transported glucose to generate glucose 6-phosphate, while in the absence of glucose the enzyme IIA<sup>Glc</sup> accumulates in its phosphorylated form. This form stimulates via adenylate cyclase the synthesis of cAMP, which is the coeffector of the global regulator Crp (cAMP receptor protein) that activates glucose-repressed genes (Brückner and Titgemeyer, 2002). The phosphorylation state of PTS proteins triggers many other regulatory responses such as chemotaxis and is therefore considered as a central element for global control. Our data indeed indicate that this might be the case as well in streptomycetes.

A model providing a possible explanation for the relationship between the uptake of GlcNAc via the PTS and

the decision to trigger the development programme is shown in Fig. 9. During GlcNAc scarcity and in the presence of glucose (Fig. 9, top), as on R2YE agar, glucose is the privileged carbon source. It is transported into the cell via the GlcP symporter and the PTS<sup>GlcNAc</sup> is expressed at its basal level (Nothaft *et al.*, 2003; van Wezel *et al.*, 2005). We have evidence that under these conditions the intracellular PTS components transfer the phosphate from PEP to PTS development-specific target proteins. As an exciting example, expression and perhaps also post-translational modification of the developmental  $\sigma$ -factor WhiG, essential for early stages of aerial growth and hence for sporulation (Chater *et al.*, 1989), is defective in the *pts* mutants (F. Titgemeyer, G.P. van Wezel and S. Rigali, in preparation). As WhiG is not essential for initiation of aerial growth, the reason why the *pts* mutants have a bald phenotype remains unclear, and the search for a *bl*d target of the PTS is one of the focal points for our research into the link between carbon utilization and development.

When the extracellular concentration of GlcNAc is high (Fig. 9, bottom), GlcNAc is transported and metabolized to GlcN-6-P, which induces the GlcNAc regulon by inhib-

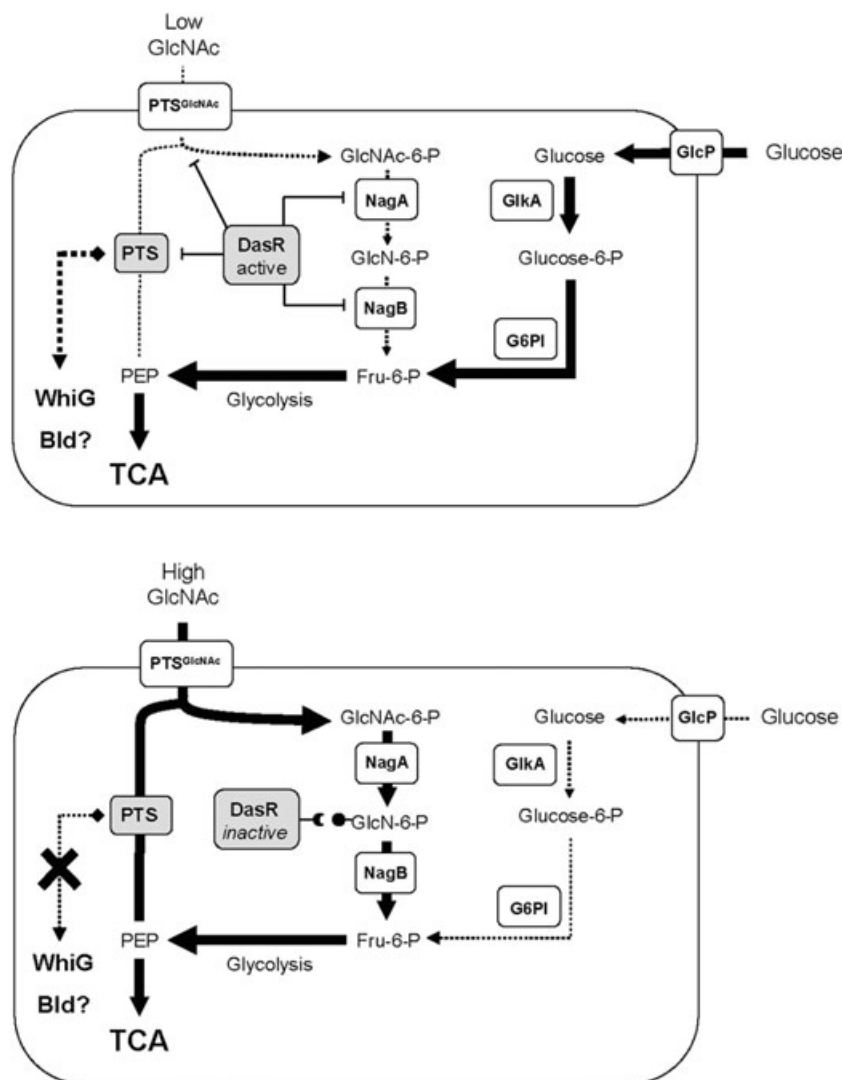

**Fig. 9.** Model of the effects of low and high *N*-acetylglucosamine (GlcNAc) in the medium. With low GlcNAc (top), glucose is the privileged carbon source, transported into the cell via the GlcP symporter and the PTS<sup>GlcNAc</sup> is expressed at its basal level. Under these conditions the intracellular PTS components transfer the phosphate from PEP to PTS development-specific target proteins, including WhiG (F. Titgemeyer, G.P. van Wezel, and S. Rigali, unpubl. data) and we propose also at least one Bld target. Most of the PEP is routed into the trichloroacetic acid (TCA) cycle. With high GlcNAc (bottom), GlcNAc is transported and metabolized to glucosamine 6-phosphate (GlcN-6-P) and this then induces the GlcNAc regulon by inhibiting DasR DNA-binding ability (Fig. 8). Under these conditions, the PTS components actively transfer the phosphate from PEP to GlcNAc, preventing the PTS phosphotransfer-mediated control of development-specific proteins.

iting DasR DNA-binding ability (Fig. 8). Under these conditions, the PTS components actively transfer the phosphate group from PEP to GlcNAc, preventing the PTS phosphotransfer-mediated control of development-specific proteins. In summary, our model predicts that the extracellular concentration of GlcNAc determines whether phosphotransfer from PEP is directed to the transported sugar or to PTS-dependent developmental proteins or molecules. This is supported by our experimental evidence (e.g. Fig. 6).

As mentioned above, nutrient deprivation is an important signal for the onset of development; this is most clearly demonstrated by the fact that submerged sporulation, in those species that show it, is strongly induced by nutritional down-shift of liquid-grown cultures, as in *S. griseus* (Kendrick and Ensign, 1983). Little is known of the nutrient-sensing system and the primary response regulon that transmits the message to the developmental

(*bld*) genes of streptomycetes. However, in a more global hierarchical view, the nutrient-sensing genes come before the *bld* genes that control the later steps towards the onset of aerial growth, i.e. after the decision to start the developmental programme has been taken. With the GlcNAc regulon we identified the first group of genes that directly connects primary metabolism to the control of development. We hypothesize that indeed also the degradation products of natural polymers such as cellulose, chitosan, starch and xylan may play a role in signalling an increasing utilization of storage material and hence impending nutrient scarcity to *Streptomyces* colonies.

We have evidence that in fact DasR is part of the nutrient-sensing system, acting as a pleiotropic, multifunctional regulator in actinomycetes, and controlling not only the GlcNAc regulon and related pathways (chitinolytic system, glutamate and Gln metabolism), but also many sugar transporters, including the *dasABC* operon

**Table 1.** Strains of *Streptomyces coelicolor* A3(2) used in this study.

Strain of <i>S. coelicolor</i>	Genotype	Reference
M145	Wild type	Kieser <i>et al.</i> (2000)
C71	<i>whiG71</i> SCP1 SCP2	Chater (1972)
J1700	<i>bldA39 hisA1 uraA1 strA1</i>	Lawlor <i>et al.</i> (1987)
J701	<i>bldB43 mthB2 cysD18 agaA7</i> SCP1 <sup>NF</sup> SCP2*	Merrick (1976)
J660	<i>bldC18 mthB2 cysD18 agaA7</i> SCP1 <sup>NF</sup> SCP2*	Merrick (1976)
J774	<i>bldD53 cysA15 pheA1 mthB2 strA1</i> SCP1 <sup>NF</sup> SCP2*	Merrick (1976)
161	<i>bldF hisD3 pheA1 strA1</i>	Puglia and Cappelletti (1984)
C103	<i>bldG103 hisA1 uraA1 strA1</i>	Champness (1988)
C109	<i>bldH109 hisA1 uraA1 strA1</i>	Champness (1988)
HU61	<i>bldJ261 hisA1 uraA1 strA1</i>	Willey <i>et al.</i> (1993)
NS17	<i>bldK::aadA</i>	Nodwell <i>et al.</i> (1996)
BAP1	<i>ptsH::aacC4</i>	Nothaft <i>et al.</i> (2003)
BAP2	<i>crr::aacC4</i>	Nothaft <i>et al.</i> (2003)
BAP3	<i>ptsI::aacC4</i>	Nothaft <i>et al.</i> (2003)
BAP4	<i>nagE1::aacC4</i>	H. Nothaft and F. Titgemeyer, unpublished data
BAP5	<i>nagE2::aacC4</i>	H. Nothaft and F. Titgemeyer, unpublished data
BAP6	<i>nagE1/E2::aacC4</i>	H. Nothaft and F. Titgemeyer, unpublished data
BAP29	<i>dasR::aacC4</i>	This work

All strains are lack plasmids SCP1 and SCP2 unless stated otherwise. *S. coelicolor* M145 was the parent for BAP1-6 and BAP29.

(S. Rigali, G.P. van Wezel and F. Titgemeyer, unpubl. data). We believe that the significant deregulation of gene expression in the *dasR* mutant is a major reason for its vegetative arrest. Microarray and proteomics analysis, as well as ChIP-on-chip analysis, are currently being undertaken to unravel the complete primary and secondary response regulons of DasR. The exciting observation that GlcN-6-P acts as an efficient effector of DasR shows that its function is strongly biased for the control of GlcNAc-related metabolism, an adaptation perhaps established during the evolution of actinomycetes in competition with chitin-containing fungi.

## Experimental procedures

### Bacterial strains and plasmids

*Escherichia coli* K-12 strains JM109 (Sambrook *et al.*, 1989) and ET12567 (MacNeil *et al.*, 1992) were used for plasmid propagation, and *E. coli* BL21(DE3) (Novagen) for subcloning and DasR overexpression experiments. The *E. coli* strains were grown in Luria–Bertani broth (LB) at 37°C and transformed by standard procedures (Sambrook *et al.*, 1989).

*Streptomyces* strains are listed and referenced in Table 1. All strains were obtained from the John Innes Centre strain collection, except the *bldJ* and *bldK* mutants, which were kindly provided by Dr Joanne Willey and Dr Justin Nodwell respectively. *S. coelicolor* A3(2) M145, the sequenced strain (Bentley *et al.*, 2002), was used as the reference (wild-type) strain. The *dasR* mutant BAP29 (M145  $\Delta$ *dasR::aacC4*) was created by replacing nucleotides 14–635 by the apramycin resistance gene cassette, using pWHM3. This is a multicopy *E. coli*–*Streptomyces* shuttle plasmid that is readily lost when antibiotic pressure (the plasmid harbours the *tsr* gene for thiostrepton resistance) is not maintained. The desired recombinants carry apramycin resistance, but are sensitive to thiostrepton due to loss of the vector sequences after double

crossing over. Verification of the correct recombination event was performed by PCR and Southern hybridization.

For complementation of the *dasR* mutant we used an insertional plasmid harbouring the *dasR* gene and its promoter region. For this purpose, we PCR-amplified a DNA fragment from the *S. coelicolor* genome encompassing nt positions –473/+954 (relative to the start of *dasR*), which was then inserted as an EcoRI–BamHI fragment into pSET151 (Bierman *et al.*, 1992) digested with the same enzymes. pSET151 lacks a *Streptomyces* origin of replication, and it can therefore be maintained only by integration into the genome. The selection marker of the plasmid is *tsr* for thiostrepton resistance.

The *pts* mutants BAP1 (*ptsH::aacC4*), BAP2 (*crr::aacC4*) and BAP3 (*ptsI::aacC4*) were described previously (Nothaft *et al.*, 2003). BAP4 ( $\Delta$ *nagE1*, nt 348–360 replaced by *aacC4*), BAP5 ( $\Delta$ *nagE2*, nt 335–677 replaced by *aacC4*) and the double mutant BAP6 (nt 348 of *nagE1* to nt 742 in *nagE2* replaced by *aacC4*) are described in H. Nothaft and F. Titgemeyer, unpublished data.

All media and routine *Streptomyces* techniques are described in the *Streptomyces* manual (Kieser *et al.*, 2000). Liquid cultures of *S. coelicolor* were grown at 28°C using tryptic soy broth without glucose as complex medium (TSB, Difco) or minimal medium (van Wezel *et al.*, 2005). SFM medium was used for making spore suspensions. R2YE agar plates were used for regeneration of protoplasts and, after addition of the appropriate antibiotic, for selecting recombinants. Phenotypic characterization of mutants was performed on SFM, R2YE and MM (minimal medium) agar plates with various carbon sources as indicated in the text (Kieser *et al.*, 2000).

### Prediction of DasR binding sites

Multiple alignments and position weight matrices were generated with the Target Explorer automated tool (Sosinsky *et al.*, 2003; Rigali *et al.*, 2004).

### Microscopy

Morphological studies of surface-grown aerial hyphae and spores of *S. coelicolor* M145 and BAP29 by cryo-SEM were performed using a JEOL JSM6700F scanning electron microscope (Keijsers *et al.*, 2003). TEM for analysis of thin sections of hyphae and spores was performed with a Philips EM410 transmission electron microscope (Mahr *et al.*, 2000). For stereomicroscopy we used an automated Zeiss Lumar V12 fluorescence microscope at 12–150× magnification, or an automated Leica MZ-16FA with up to 180× magnification and a compound lens for maximal 660× magnification, to establish the presence of aerial hyphae and spores. Phase-contrast microscopy was performed with a Zeiss standard 25 microscope with 100–1000× magnification. A 5-Mp CCD camera was used for photography. Images were acquired using the supplier's software and processed by Adobe Photoshop CS2 (Version 9.0).

### Sugar uptake

Uptake of *N*-[<sup>14</sup>C]acetyl-D-glucosamine (6.2 mCi mmol<sup>-1</sup>) into mycelium was measured at a concentration of 20 μM as described (Nothaft *et al.*, 2003). Results were the average of three independent experiments.

### Protein purification and Western blotting

Purification of recombinant His-tagged DasR (Rigali *et al.*, 2004) and Western blot analysis with antibodies raised against HPr and IIA<sup>Crr</sup> were described elsewhere (Nothaft *et al.*, 2003).

### Reverse transcription polymerase chain reaction (RT-PCR)

RNA was isolated from mycelium of *S. coelicolor* M145 and BAP29. Minimal medium cultures containing 50 mM glycerol were inoculated with spores and grown to OD<sub>550</sub> of 0.7 (exponential growth). GlcNAc was added at 0.5% and samples were taken after 0, 15, 30 and 60 min. RT-PCR analyses were conducted with the Superscript III one-step RT-PCR Kit (Invitrogen). RT-PCRs without reverse transcription were used as control for absence of residual DNA. For semiquantitative analysis, samples were taken at three-cycle intervals between cycles 18 and 35 to compare non-saturated PCR product formation. Data were verified in at least three independent experiments.

### Electromobility gel shift assay (EMSA)

Electromobility gel shift assays (EMSAs) were performed as described (Rigali *et al.*, 2004) or with fluorescent probes (10 nM) with an ALF express sequencer (Filee *et al.*, 2001). Purified DasR (3 μM) and 1000-fold excess of non-specific DNA were used in the reaction mixture. Probes for the DNA-binding experiments were amplified by PCR with oligonucleotides 5'-GAGCGGGGACGAGACGGTGGTCATGGG-3' and 5'-GGTGCAAATCCGTGAGGAGTGTGG for the upstream region of *crr* (-149/+24 relative to the *crr* translational

start) and 5'-TCGCCGCCCGCCTTGGCATCG-3' and 5'-GTTCACTGACCTGACACCGCCG-3' for the upstream region of *nagB* (-148/-27 relative to the translational start of *nagB*). The DNA fragments included the predicted DasR binding sites TGTGGTCTAGACCTCT (for *crr-ptsI*; nt positions -115/-130) or TGTGGTTTAGACCAAT (for *nagB*; nt positions -52/-67, on the opposite strand).

### Acknowledgements

The authors would like to dedicate this article to the memory of Dr Pieter W. Postma, who was a driving force behind the research on the PTS. The work was supported by grants from the Royal Netherlands Academy for Arts and Sciences (KNAW) and from the Netherlands Organization for Scientific Research (NWO) to G.P.v.W., and by grants SFB473 and GK805 of the *Deutsche Forschungsgemeinschaft* to F.T. S.R. was supported by an ECHO grant from the Netherlands Organization for Scientific Research (NWO) and the patrimoine of the University of Liège (Belgium) and S.C. is a research fellow of the Fund of Research in Industry and Agriculture (FRIA). We are grateful to Justin Nodwell for the *bltKa* mutant, to Joan Willey for the *bltJ* mutant, and to Paul Hoskisson and Richard Losick for valuable discussions.

### References

- Angell, S., Lewis, C.G., Buttner, M.J., and Bibb, M.J. (1994) Glucose repression in *Streptomyces coelicolor* A3(2): a likely regulatory role for glucose kinase. *Mol Gen Genet* **244**: 135–143.
- Bentley, S.D., Chater, K.F., Cerdano-Tarraga, A.M., Challis, G.L., Thomson, N.R., *et al.* (2002) Complete genome sequence of the model actinomycete *Streptomyces coelicolor* A3(2). *Nature* **417**: 141–147.
- Bierman, M., Logan, R., O'Brien, K., Seno, E.T., Rao, R.N., and Schoner, B.E. (1992) Plasmid cloning vectors for the conjugal transfer of DNA from *Escherichia coli* to *Streptomyces* spp. *Gene* **116**: 43–49.
- Brückner, R., and Titgemeyer, F. (2002) Carbon catabolite repression in bacteria: choice of the carbon source and autoregulatory limitation of sugar utilization. *FEMS Microbiol Lett* **209**: 141–148.
- Chamness, W.C. (1988) New loci required for *Streptomyces coelicolor* morphological and physiological differentiation. *J Bacteriol* **170**: 1168–1174.
- Chater, K.F. (1972) A morphological and genetic mapping study of white colony mutants of *Streptomyces coelicolor*. *J Gen Microbiol* **72**: 9–28.
- Chater, K.F. (1998) taking a genetic scalpel to the streptomycetes colony. *Microbiology* **144**: 1465–1478.
- Chater, K.F. (2001) Regulation of sporulation in *Streptomyces coelicolor* A3(2): a checkpoint multiplex? *Curr Opin Microbiol* **4**: 667–673.
- Chater, K.F., and Horinouchi, S. (2003) Signalling early developmental events in two highly diverged *Streptomyces* species. *Mol Microbiol* **48**: 9–15.
- Chater, K.F., Bruton, C.J., Plaskitt, K.A., Buttner, M.J., Mendez, C., and Helmann, J.D. (1989) The developmental

- fate of *S. coelicolor* hyphae depends upon a gene product homologous with the motility sigma factor of *B. subtilis*. *Cell* **59**: 133–143.
- Claessen, D., Rink, R., de Jong, W., Siebring, J., de Vreugd, P., Boersma, F.G., et al. (2003) A novel class of secreted hydrophobic proteins is involved in aerial hyphae formation in *Streptomyces coelicolor* by forming amyloid-like fibrils. *Genes Dev* **17**: 1714–1726.
- Delic, V., Pigac, J., and Sermonti, G. (1969) Detection and study of cosynthesis of tetracycline antibiotics by an agar method. *J Gen Microbiol* **55**: 103–108.
- Dworkin, J., and Losick, R. (2005) Developmental commitment in a bacterium. *Cell* **121**: 401–409.
- Eccleston, M., Ali, R.A., Seyler, R., Westpheling, J., and Nodwell, J. (2002) Structural and genetic analysis of the BldB protein of *Streptomyces coelicolor*. *J Bacteriol* **184**: 4270–4276.
- Elliot, M.A., Locke, T.R., Galibois, C.M., and Leskiw, B.K. (2003) BldD from *Streptomyces coelicolor* is a non-essential global regulator that binds its own promoter as a dimer. *FEMS Microbiol Lett* **225**: 35–40.
- Filee, P., Delmarcelle, M., Thamm, I., and Joris, B. (2001) Use of an ALFexpress DNA sequencer to analyze protein–nucleic acid interactions by band shift assay. *Biotechniques* **30**: 1050–1041.
- Flårdh, K., Findlay, K.C., and Chater, K.F. (1999) Association of early sporulation genes with suggested developmental decision points in *Streptomyces coelicolor* A3(2). *Microbiology* **145**: 2229–2243.
- Hopwood, D.A., Wildermuth, H., and Palmer, H.M. (1970) Mutants of *Streptomyces coelicolor* defective in sporulation. *J Gen Microbiol* **61**: 397–408.
- Hopwood, D.A., Chater, K.F., Dowding, J.E., and Vivian, A. (1973) Advances in *Streptomyces coelicolor* genetics. *Bacteriol Rev* **37**: 371–405.
- Keijser, B.J., Noens, E.E., Kraal, B., Koerten, H.K., and van Wezel, G.P. (2003) The *Streptomyces coelicolor* *ssgB* gene is required for early stages of sporulation. *FEMS Microbiol Lett* **225**: 59–67.
- Kelemen, G.H., and Buttner, M.J. (1998) Initiation of aerial mycelium formation in *Streptomyces*. *Curr Opin Microbiol* **1**: 656–662.
- Kendrick, K.E., and Ensign, J.C. (1983) Sporulation of *Streptomyces griseus* in submerged culture. *J Bacteriol* **155**: 357–366.
- Kieser, T., Bibb, M.J., Buttner, M.J., Chater, K.F., and Hopwood, D.A. (2000) *Practical Streptomyces Genetics*. Norwich: John Innes Foundation.
- Kodani, S., Hudson, M.E., Durrant, M.C., Buttner, M.J., Nodwell, J.R., and Willey, J.M. (2004) The SapB morphogen is a lantibiotic-like peptide derived from the product of the developmental gene *ramS* in *Streptomyces coelicolor*. *Proc Natl Acad Sci USA* **101**: 11448–11453.
- Lawlor, E.J., Baylis, H.A., and Chater, K.F. (1987) Pleiotropic morphological and antibiotic deficiencies result from mutations in a gene encoding a tRNA-like product in *Streptomyces coelicolor* A3(2). *Genes Dev* **1**: 1305–1310.
- McCormick, J.R., Su, E.P., Driks, A., and Losick, R. (1994) Growth and viability of *Streptomyces coelicolor* mutant for the cell division gene *ftsZ*. *Mol Microbiol* **14**: 243–254.
- MacNeil, D.J., Gewain, K.M., Ruby, C.L., Dezeny, G., Gibbons, P.H., and MacNeil, T. (1992) Analysis of *Streptomyces avermitilis* genes required for avermectin biosynthesis utilizing a novel integration vector. *Gene* **111**: 61–68.
- Mahr, K., van Wezel, G.P., Svensson, C., Krengel, U., Bibb, M.J., and Titgemeyer, F. (2000) Glucose kinase of *Streptomyces coelicolor* A3(2): large-scale purification and biochemical analysis. *Antonie Van Leeuwenhoek* **78**: 253–261.
- Merrick, M.J. (1976) A morphological and genetic mapping study of bald colony mutants of *Streptomyces coelicolor*. *J Gen Microbiol* **96**: 299–315.
- Nodwell, J.R., MCGovern, K., and Losick, R. (1996) An oligopeptide permease responsible for the import of an extracellular signal governing aerial mycelium formation in *streptomyces coelicolor*. *Mol Microbiol* **22**: 881–893.
- Nodwell, J.R., Yang, M., Kuo, D., and Losick, R. (1999) Extracellular complementation and the identification of additional genes involved in aerial mycelium formation in *Streptomyces coelicolor*. *Genetics* **151**: 569–584.
- Noens, E.E., Mersinias, V., Traag, B.A., Smith, C.P., Koerten, H.K., and van Wezel, G.P. (2005) SsgA-like proteins determine the fate of peptidoglycan during sporulation of *Streptomyces coelicolor*. *Mol Microbiol* **58**: 929–944.
- Nothaft, H., Dresel, D., Willimek, A., Mahr, K., Niederweis, M., and Titgemeyer, F. (2003) The phosphotransferase system of *Streptomyces coelicolor* is biased for N-acetylglucosamine metabolism. *J Bacteriol* **185**: 7019–7023.
- Pope, M.K., Green, B.D., and Westpheling, J. (1996) The *bld* mutants of *Streptomyces coelicolor* are defective in the regulation of carbon utilization, morphogenesis and cell signalling. *Mol Microbiol* **19**: 747–756.
- Pope, M.K., Green, B., Westpheling, J.R.W., IV (1998) The *bldb* gene encodes a small protein required for morphogenesis, antibiotic production, and catabolite control in *streptomyces coelicolor*. *J Bacteriol* **180**: 1556–1562.
- Puglia, A.M., and Cappelletti, E. (1984) A bald superfertile U.V.-resistant strain in *Streptomyces coelicolor* A3(2). *Microbiologica* **7**: 263–266.
- Rigali, S., Derouaux, A., Giannotta, F., and Dusart, J. (2002) Subdivision of the helix–turn–helix GntR family of bacterial regulators in the FadR, HutC, MocR, and YtrA subfamilies. *J Biol Chem* **277**: 12507–12515.
- Rigali, S., Schlicht, M., Hoskisson, P., Nothaft, H., Merzbacher, M., Joris, B., and Titgemeyer, F. (2004) Extending the classification of bacterial transcription factors beyond the helix–turn–helix motif as an alternative approach to discover new *cis/trans* relationships. *Nucleic Acids Res* **32**: 3418–3426.
- Sambrook, J., Fritsch, E.F., and Maniatis, T. (1989) *Molecular Cloning: A Laboratory Manual*. Cold Spring Harbor, NY: Cold Spring Harbor Laboratory Press.
- Schauer, A., Ranes, M., Santamaria, R., Guijarro, J., Lawlor, E., Mendez, C., et al. (1988) Visualizing gene expression in time and space in the filamentous bacterium *Streptomyces coelicolor*. *Science* **240**: 768–772.
- Seo, J.W., Ohnishi, Y., Hirata, A., and Horinouchi, S. (2002) ATP-binding cassette transport system involved in regulation of morphological differentiation in response to glucose in *Streptomyces griseus*. *J Bacteriol* **184**: 91–103.

- Soliveri, J.A., Gomez, J., Bishai, W.R., and Chater, K.F. (2000) Multiple paralogous genes related to the *Streptomyces coelicolor* developmental regulatory gene *whiB* are present in *Streptomyces* and other actinomycetes. *Microbiology* **146**: 333–343.
- Sosinsky, A., Bonin, C.P., Mann, R.S., and Honig, B. (2003) Target Explorer: an automated tool for the identification of new target genes for a specified set of transcription factors. *Nucleic Acids Res* **31**: 3589–3592.
- Stephens, C. (1998) Bacterial sporulation: a question of commitment? *Curr Biol* **8**: R45–R48.
- Viollier, P.H., Minas, W., Dale, G.E., Folcher, M., and Thompson, C.J. (2001) Role of acid metabolism in *Streptomyces coelicolor* morphological differentiation and antibiotic biosynthesis. *J Bacteriol* **183**: 3184–3192.
- Wang, F., Xiao, X., Saito, A., and Schrempf, H. (2002) *Streptomyces olivaceoviridis* possesses a phosphotransferase system that mediates specific, phosphoenolpyruvate-dependent uptake of *N*-acetylglucosamine. *Mol Genet Genomics* **268**: 344–351.
- van Wezel, G.P., van der Meulen, J., Taal, E., Koerten, H., and Kraal, B. (2000a) Effects of increased and deregulated expression of cell division genes on the morphology and on antibiotic production of streptomycetes. *Antonie Van Leeuwenhoek* **78**: 269–276.
- van Wezel, G.P., van der Meulen, J., Kawamoto, S., Luiten, R.G., Koerten, H.K., and Kraal, B. (2000b) *ssgA* is essential for sporulation of *Streptomyces coelicolor* A3(2) and affects hyphal development by stimulating septum formation. *J Bacteriol* **182**: 5653–5662.
- van Wezel, G.P., Mahr, K., König, M., Traag, B.A., Pimentel-Schmitt, E.F., Willimek, A., and Titgemeyer, F. (2005) GlcP constitutes the major glucose uptake system of *Streptomyces coelicolor* A3(2). *Mol Microbiol* **55**: 624–636.
- Willey, J., Santamaria, R., Guijarro, J., Geistlich, M., and Losick, R. (1991) Extracellular complementation of a developmental mutation implicates a small sporulation protein in aerial mycelium formation by *S. coelicolor*. *Cell* **65**: 641–650.
- Willey, J., Schwedock, J., and Losick, R. (1993) Multiple extracellular signals govern the production of a morphogenetic protein involved in aerial mycelium formation by *Streptomyces coelicolor*. *Genes Dev* **7**: 895–903.
- Willey, J.M., Willems, A., Kodani, S., and Nodwell, J.R. (2006) Morphogenetic surfactants and their role in the formation of aerial hyphae in *Streptomyces coelicolor*. *Mol Microbiol* **59**: 731–742.
- Xiao, X., Wang, F., Saito, A., Majka, J., Schlosser, A., and Schrempf, H. (2002) The novel *Streptomyces olivaceoviridis* ABC transporter Ngc mediates uptake of *N*-acetylglucosamine and *N,N'*-diacetylchitobiose. *Mol Genet Genomics* **267**: 429–439.

### Supplementary material

The following supplementary material is available for this article online:

**Fig. S1.** *N*-acetylglucosamine (GlcNAc) is transported by NagE2. Mutants deleted for the transport genes *nagE1* (SCO2906), *nagE2* (SCO2907) or both were spread on R2YE agar with or without GlcNAc (1% w/v). Other strains are: *S. coelicolor* M145 (parent of all mutants), *dasR* mutant BAP29 and the *pts* mutants *ptsH* (BAP1), *crr* (BAP2) and *ptsl* (BAP3). (For phenotypes of the *pts* mutants see also Fig. 3A.) In the absence of *nagE2* (or *nagE2* and *nagE1*) addition of GlcNAc has no effect on development, while the *nagE1* mutant and the parent strain M145 are arrested in the vegetative state. This proves that *nagE2* is indeed the transporter of GlcNAc and is essential for import of this inducer molecule for the DasR control system.

**Fig. S2.** Complementation of the *dasR* mutants by the *pts* mutants. For experimental details see Fig. 3. Note that BAP29 (M145  $\Delta$ *dasR*) fails to complement the *pts* mutants, and that only very sparse aerial mycelium is formed by the *dasR* mutant.

**Fig. S3.** Phenotypes of the *bld* mutants on R2YE agar. All *bld* mutants described in Fig. 3 were streaked individually on R2YE agar. For strains and growth conditions see Fig. 3. Note that the *bldF* and *bldK* mutants are strongly pigmented under these conditions.

This material is available as part of the online article from <http://www.blackwell-synergy.com>